

Operating Instructions

OUSAF11

Optical sensor for the measurement of VIS/NIR absorption

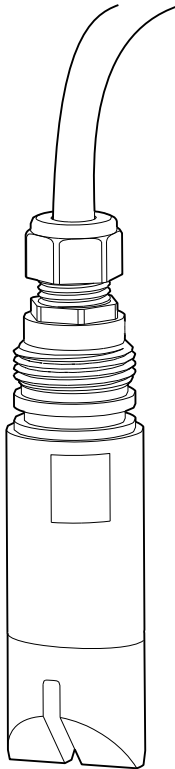





Table of contents







1	Document information	4	9.3	Disposal	23
1.1	Warnings	4	10	Accessories	23
1.2	Symbols	4	10.1	Assembly	24
1.3	Symbols on the product	5	11	Technical data	24
2	Basic safety instructions	6	Index		27
2.1	Requirements for the personnel	6			
2.2	Designated use	6			
2.3	Occupational safety	6			
2.4	Operational safety	6			
2.5	Product safety	7			
3	Product description	7			
3.1	Sensor design	7			
3.2	Measuring principle	8			
4	Incoming acceptance and product identification	9			
4.1	Incoming acceptance	9			
4.2	Product identification	9			
4.3	Scope of delivery	10			
4.4	Certificates and approvals	10			
5	Installation	11			
5.1	Installation conditions	11			
5.2	Mounting the sensor	14			
5.3	Post-installation check	15			
6	Electrical connection	15			
6.1	Connecting the sensor	15			
6.2	Lamp voltage	16			
6.3	Ensuring the degree of protection	16			
6.4	Post-connection check	16			
7	Commissioning	17			
7.1	Function check	17			
7.2	Calibrating/adjusting the sensor	17			
8	Maintenance	17			
8.1	Maintenance schedule	17			
8.2	Clean sensor	18			
8.3	Replace lamp	18			
8.4	Replacing the O-ring	20			
9	Repairs	23			
9.1	Spare parts	23			
9.2	Return	23			

1 Document information

1.1 Warnings

Structure of information	Meaning
 <p>Causes (/consequences) Consequences of non-compliance (if applicable) ▶ Corrective action</p>	<p>This symbol alerts you to a dangerous situation. Failure to avoid the dangerous situation will result in a fatal or serious injury.</p>
 <p>Causes (/consequences) Consequences of non-compliance (if applicable) ▶ Corrective action</p>	<p>This symbol alerts you to a dangerous situation. Failure to avoid the dangerous situation can result in a fatal or serious injury.</p>
 <p>Causes (/consequences) Consequences of non-compliance (if applicable) ▶ Corrective action</p>	<p>This symbol alerts you to a dangerous situation. Failure to avoid this situation can result in minor or more serious injuries.</p>
 <p>Cause/situation Consequences of non-compliance (if applicable) ▶ Action/note</p>	<p>This symbol alerts you to situations which may result in damage to property.</p>

1.2 Symbols

Symbol	Meaning
	Additional information, tips
	Permitted or recommended
	Not permitted or not recommended
	Reference to device documentation
	Reference to page
	Reference to graphic
	Result of a step

1.3 Symbols on the product

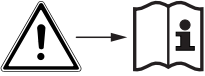
Symbol	Meaning
	Reference to device documentation

2 Basic safety instructions

2.1 Requirements for the personnel

- Installation, commissioning, operation and maintenance of the measuring system may be carried out only by specially trained technical personnel.
 - The technical personnel must be authorized by the plant operator to carry out the specified activities.
 - The electrical connection may be performed only by an electrical technician.
 - The technical personnel must have read and understood these Operating Instructions and must follow the instructions contained therein.
 - Measuring point faults may be repaired only by authorized and specially trained personnel.
-  Repairs not described in the Operating Instructions provided may only be carried out directly by the manufacturer or by the service organization.

2.2 Designated use

The OUSAF11 sensor measures the VIS/NIR absorption of liquids. The sensor is suitable for use in a wide range of applications, such as:

- Interphase detection
- Applications in the food and beverage industry
 - Milk detection in CIP solutions
 - Phase separation, e.g. milk/water
 - Product loss detection in outlet
- Measurement of solids in:
 - Primary industry
 - Mining

Use of the device for any purpose other than that described, poses a threat to the safety of people and of the entire measuring system and is therefore not permitted.

The manufacturer is not liable for damage caused by improper or non-designated use.

2.3 Occupational safety

As the user, you are responsible for complying with the following safety conditions:

- Installation guidelines
- Local standards and regulations

Electromagnetic compatibility

- The product has been tested for electromagnetic compatibility in accordance with the applicable European standards for industrial applications.
- The electromagnetic compatibility indicated applies only to a product that has been connected in accordance with these Operating Instructions.

2.4 Operational safety

1. Before commissioning the entire measuring point, verify that all connections are correct. Ensure that electrical cables and hose connections are undamaged.

2. Do not operate damaged products, and safeguard them to ensure that they are not operated inadvertently. Label the damaged product as defective.
3. If faults cannot be rectified:
Take the products out of operation and safeguard them to ensure that they are not operated inadvertently.

2.5 Product safety

The product is designed to meet state-of-the-art safety requirements, has been tested, and left the factory in a condition in which it is safe to operate. The relevant regulations and European standards have been observed.

3 Product description

3.1 Sensor design

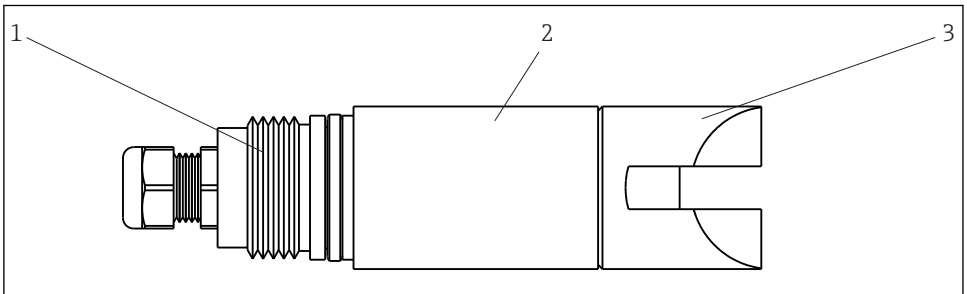

A0021712

1 Design of OUSAF11

- 1 Process connection (e.g. external thread)
- 2 Sensor shaft
- 3 Sensor head

3.2 Measuring principle

Light absorption

The measuring principle is based on the Lambert-Beer law.

There is a linear dependency between the absorption of light and the concentration of the absorbing substance:

$$A = -\log(T) = \varepsilon \cdot c \cdot OPL$$

$$T = I/I_0$$

T ... Transmission

I ... Intensity of received light at detector

I₀ ... Intensity of transmitted light of light source

A ... Absorption

ε ... Extinction coefficient

c ... Concentration

OPL ... Optical path length

A light source emits radiation through the medium and the incident radiation is measured on the detector side.

The intensity of the light is determined by a photodiode and converted to a photocurrent.

The subsequent conversion to absorbance units (AU, OD) is performed in the associated transmitter.

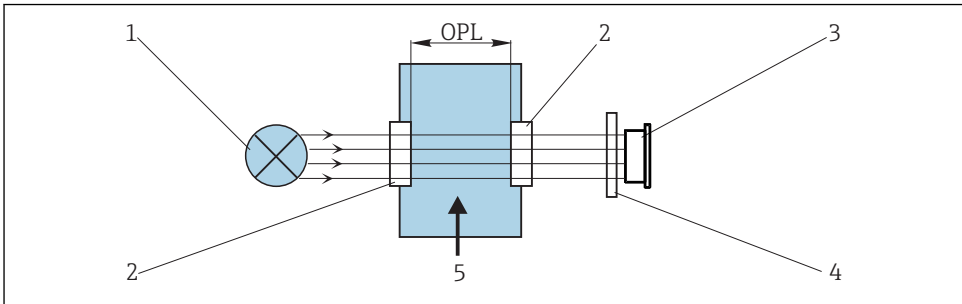

A0029401

2 Absorption measurement

1 Light source

2 Optical windows of the sensor

3 Detector

4 Measurement filter (depends on sensor, not provided on all sensors)

5 Medium flow

4 Incoming acceptance and product identification

4.1 Incoming acceptance

1. Verify that the packaging is undamaged.
 - ↳ Notify your supplier of any damage to the packaging.
Keep the damaged packaging until the matter has been settled.
2. Verify that the contents are undamaged.
 - ↳ Notify your supplier of any damage to the delivery contents.
Keep the damaged products until the matter has been settled.
3. Check the delivery for completeness.
 - ↳ Check it against the delivery papers and your order.
4. Pack the product for storage and transportation in such a way that it is protected against impact and moisture.
 - ↳ The original packaging offers the best protection.
The permitted ambient conditions must be observed (see "Technical data").

If you have any questions, please contact your supplier or your local sales center.

4.2 Product identification

4.2.1 Nameplate

The nameplate provides you with the following information on your device:

- Manufacturer identification
 - Order code
 - Extended order code
 - Serial number
 - Safety information and warnings
- ▶ Compare the data on the nameplate with your order.

4.2.2 Product identification

Product page

www.endress.com/ousaf11

Interpreting the order code

The order code and serial number of your product can be found in the following locations:

- On the nameplate
- In the delivery papers

Obtaining information on the product

1. Go to the product page for your product on the Internet.

2. At the bottom of the page, select the "Online Tools" link followed by "Check your device features".
 - ↳ An additional window opens.
3. Enter the order code from the nameplate into the search field, and then select "Show details".
 - ↳ You will receive information on each feature (selected option) of the order code.

4.3 Scope of delivery

The scope of delivery consists of the following :

- OUSAF11 sensor
- Operating Instructions



Ordering the sensor together with a transmitter:

If you select the calibration option in the **Product Configurator for the transmitter**, the complete measuring system (transmitter, sensor, cable) is factory-calibrated and shipped as one package.

If you have any questions, please contact your supplier or your local sales center.

4.4 Certificates and approvals

4.4.1 CE mark

Declaration of Conformity

The product meets the requirements of the harmonized European standards. As such, it complies with the legal specifications of the EU directives. The manufacturer confirms successful testing of the product by affixing to it the CE mark.

4.4.2 FDA conformity

All non-metal parts in contact with medium, such as rubber and plastic parts, meet the requirements of FDA 21 CFR 177.2600. The plastic and elastomer parts of the sensor in contact with medium have passed the biological reactivity tests according to USP <87> and <88> Class VI.

4.4.3 3-A

Certified according to the 3-A standard 46-xx for versions with Tri-Clamp and Varivent process connections

3-A hygiene standard for sensors whose spare parts and process connections are designed for use in milk and dairy product plants

5 Installation

5.1 Installation conditions

5.1.1 Measuring system

An optical measuring system comprises:

- OUSAF11 sensor (photometer)
- Transmitter, for example Liquiline CM44P
- Sensor fixed cable

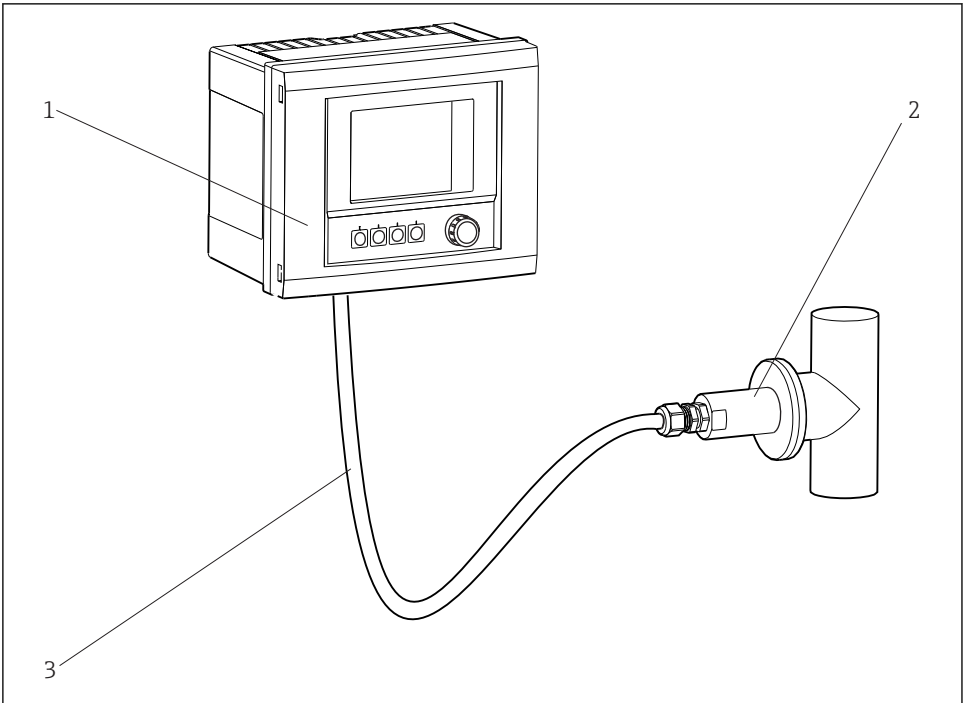

A0029243

▣ 3 Example of a measuring system with a photometer sensor

- 1 CM44P transmitter
- 2 OUSAF11 sensor
- 3 Sensor fixed cable

5.1.2 Dimensions

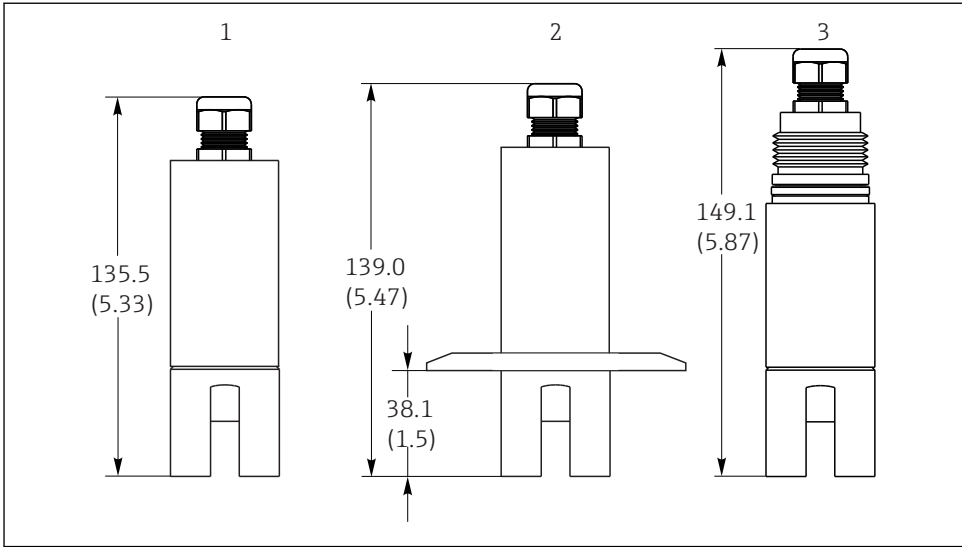

A0021260

4 Design and dimensions in mm (inch)

- 1 Submersible sensor
- 2 Tri-Clamp or VARIVENT process connection
- 3 Sensor with external thread

5.1.3 Mounting angles

The sensor can be installed up to the horizontal in an assembly, support or suitable process connection. Other angles of inclination are not recommended.

Do not install the sensor vertically through the floor of a pipe. In this way, you avoid any sedimentation and ensure a constant flow through the measuring gap. This guarantees correct measured values and complete drainage in hygienic applications.

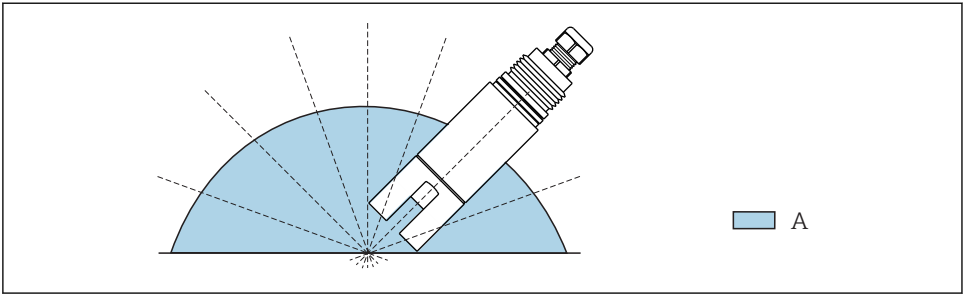

A0029248

5 Mounting angles

A Permitted mounting angle: 0 to 180°

5.1.4 Mounting in pipes

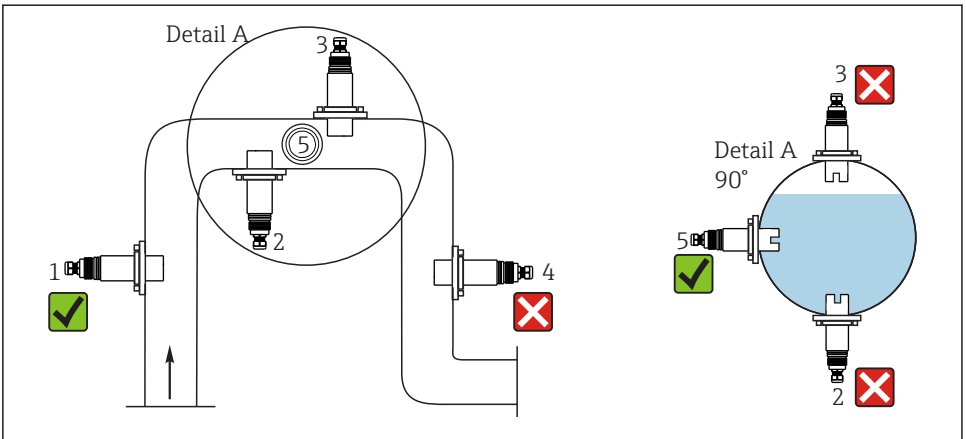

A0029259

6 Permitted and unacceptable installation positions in pipes

Comply with the following conditions. Otherwise you run the risk of damaging the measuring point or obtaining incorrect measured values.

- ▶ The diameter of the pipe must be at least 50 mm (2").
- ▶ Install the sensor in places with consistent flow conditions.
- ▶ The best installation location is in the ascending pipe (item 1).
- ▶ Installation in the horizontal pipe (item 5) is also possible. In this case, you must turn the sensor so that the measuring slit is aligned with the direction of flow at an angle of at least 12° but not more than 45°. → diagram

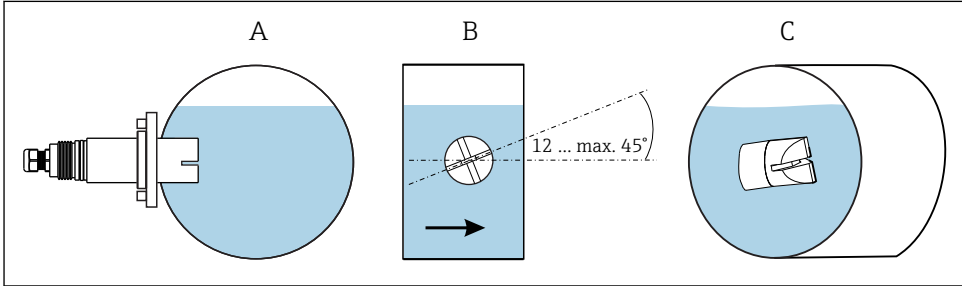

A0031255

☒ 7 3-A-permitted sensor orientation when installed in horizontal pipes

A → ☒ 13, item 5

B Lateral view (270° in relation to A), arrow indicates the direction of flow

C 3D view

- ▶ Do not install the sensor in places where air pockets or bubbles occur (→ ☒ 6, ☒ 13, item 3) or where sedimentation may occur (item 2).
- ▶ Avoid installation in the down pipe (item 4).
- ▶ Align the sensor in such a way that the medium flows through the measuring gap (self-cleaning effect).

5.2 Mounting the sensor

NOTICE

Mounting errors

Possibility of sensor damage, twisted cables or similar

- ▶ Make sure that the sensor body is protected against damage from external forces - such as trolleys on adjacent paths.
- ▶ Make sure to avoid exerting excessive tensile force on the cable (e.g. from jerky pulling movements).
- ▶ Make sure to observe the national grounding regulations when using metal assemblies.

The sensor can be installed directly in tanks and pipes with a suitable process connection, or in a suitable assembly.

5.3 Post-installation check

Put the sensor into operation only if you can answer "yes" to the following questions:

- Are the sensor and cable undamaged?
- Have you chosen a correct mounting angle?

6 Electrical connection



Device is live

Incorrect connection may result in injury or death

- ▶ The electrical connection may be performed only by an electrical technician.
- ▶ The electrical technician must have read and understood these Operating Instructions and must follow the instructions contained therein.
- ▶ **Prior** to commencing connection work, ensure that no voltage is present on any cable.

6.1 Connecting the sensor

The sensor is connected to the transmitter using the pre-terminated or labeled sensor fixed cable.

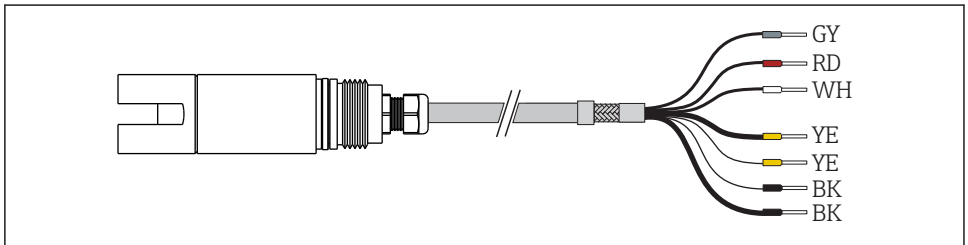

A0029261

8 OUSAF11 fixed cable

CM44P terminal	CVM40 terminal	Cable color	Assignment
P+	V1.1	YE (thick)	Lamp voltage +
S+	V1.3	YE (thin)	Detection of lamp voltage +
S-	V1.4	BK (thin)	Detection of lamp voltage -
P-	V1.2	BK (thick)	Lamp voltage -
A (1)	S1.1	RD	Sensor +
C(1)	S1.2	WH	Sensor -
SH (1)	S1.S	GY	Shield

6.2 Lamp voltage

Sensor version	Lamp type	Lamp voltage [V]
OUSAF11-xxxxx	Incandescent lamp	4.9 ± 0.1

6.3 Ensuring the degree of protection

Only the mechanical and electrical connections which are described in these instructions and which are necessary for the required, designated use, may be carried out on the device delivered.

- ▶ Exercise care when carrying out the work.

Individual types of protection permitted for this product (impermeability (IP), electrical safety, EMC interference immunity) can no longer be guaranteed if, for example:

- Covers are left off.
- Different power units to the ones supplied are used.
- Cable glands are not sufficiently tightened (must be tightened with 2 Nm for the confirmed level of IP protection).
- Modules are not fully secured.
- The display is not fully secured (risk of moisture entering due to inadequate sealing).
- Loose or insufficiently tightened cables/cable ends.
- Conductive cable strands are left in the device.

6.4 Post-connection check

Device condition and specifications	Notes
Are the sensor, assembly and cable free from damage on the outside?	Visual inspection

Electrical connection	Notes
Does the supply voltage of the connected transmitter match the data on the nameplate?	Visual inspection
Are the installed cables strain-relieved and not twisted?	
Has the cable been routed without loops and cross-overs?	Check that it is firmly seated (by pulling gently)
Are the signal cables connected correctly according to the connection diagram?	
Are all cable entries mounted, tightened and leak-tight?	For lateral cable entries, make sure the cables loop downwards to allow water to drip off.
Are the PE distributor rails grounded (if present)?	Grounding at the point of installation

7 Commissioning

7.1 Function check

Before first commissioning, check if:

- ▶ the sensor is correctly installed
- ▶ the electrical connection is correct.

7.2 Calibrating/adjusting the sensor

Measuring points consisting of a photometer sensor and a transmitter are adjusted at the factory. Normally adjustment is not required when commissioning for the first time.

If an adjustment is necessary nevertheless, you have the following adjustment option:
Adjustment with calibration standards

8 Maintenance

Take all the necessary precautions in time to ensure the operational safety and reliability of the entire measuring system.

NOTICE

Effects on process and process control

- ▶ When carrying out any work on the system, take into account possible repercussions for process control or the process itself.
- ▶ For your own safety, only use genuine accessories. With genuine parts, the function, accuracy and reliability are also ensured after maintenance work.

NOTICE

Sensitive optical components

If you do not proceed with care, you can damage or severely dirty the optical components.

- ▶ Maintenance work may only be carried out by appropriately qualified staff.
- ▶ Wear talc-free latex or cotton gloves during maintenance.
- ▶ Use ethanol and a lint-free cloth which is suitable for cleaning lenses to clean all the optical components.

8.1 Maintenance schedule

- Maintenance and servicing intervals are based on the individual application.
- Cleaning intervals depend on the medium.
- Perform a visual inspection once a month and clean the sensor if necessary.

Maintenance checklist

- Replace lamp
 - The lamp is typically replaced after 8000 to 10 000 operating hours (→ ☞ 26).
- Replace O-rings in contact with the medium
 - The replacement of O-rings in contact with the medium depends on the specific requirements of the process.
 - Never re-use a used O-ring.

8.2 Clean sensor

Cleaning the sensor

If the sensor is dirty, this can influence the measurement results and even cause a malfunction. Therefore the sensor must be cleaned regularly in order to guarantee reliable measurement results. The frequency and intensity of the cleaning process depend on the medium. Clean the sensor:

- before every calibration/adjustment/zero point adjustment
- before you send the sensor in for repair

Fouling	Cleaning
Lime deposits	▶ Immerse the sensor in 1-5 % hydrochloric acid (for a few minutes).
Dirt particles on the optical windows	▶ Fold the cloth and wipe the cell.

NOTICE

Cleaning agent residue

Cleaning agent residue can affect the measurement.

- ▶ Rinse the sensor carefully with water after every cleaning.

8.3 Replace lamp

- ▶ Switch off the lamp at the transmitter using the software function.
- ▶ Allow the lamp to cool down (30 minutes).

1.

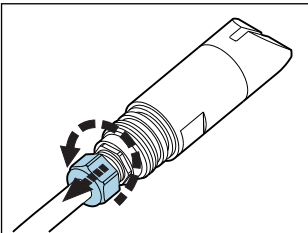

Release the cable gland and pull it over the cable to remove it from the sensor.

2. NOTICE**Incorrect turning**

The cables can be damaged and the sensor no longer functions

- ▶ Only turn the shaft. Never turn by the sensor head!
- ▶ Make sure that the cable is not twisted.

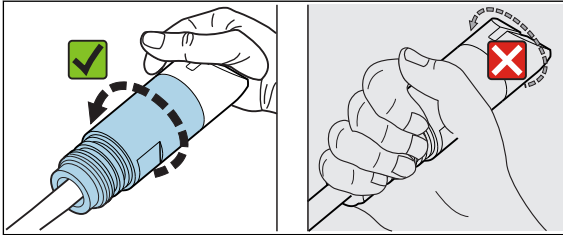

Hold the sensor head firmly in position and unscrew the sensor shaft from the sensor head.

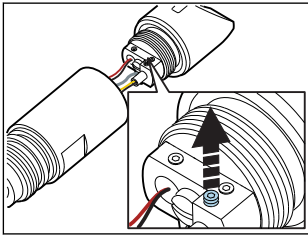
3.

Using the Allen screw remove the securing screw indicated from the lamp kit (71122199).

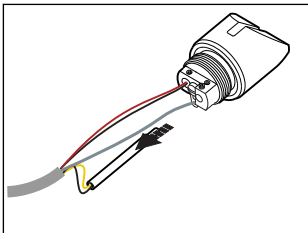
4.

Remove the lamp module from the sensor head.

5.

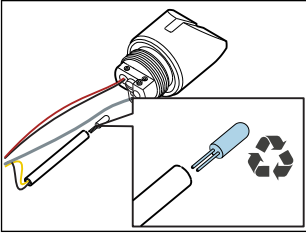

Remove the lamp from the fitting and replace it with a new one. Use a paper towel to insert the new lamp.

6. **Without graphics:**

Once you have inserted the new lamp, clean it with a paper towel and ethanol, if available. Make sure you do not touch the optical surfaces again after cleaning.

7. Insert the lamp module back into the sensor head until it is firmly seated in the correct position. Tighten the securing screw slightly.

8. Mount the sensor again.  In doing so, use PTFE tape to seal the thread of the sensor head.

↳ Check the function of the sensor afterwards.

Always replace the O-ring each time you replace the lamp. Read the following section for this purpose.

8.4 Replacing the O-ring

- ▶ Switch off the lamp at the transmitter using the software function.
- ▶ Allow the lamp to cool down (30 minutes).

1.

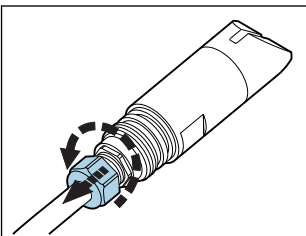

Release the cable gland and pull it over the cable to remove it from the sensor.

2. NOTICE**Incorrect turning**

The cables can be damaged and the sensor no longer functions

- ▶ Only turn the shaft. Never turn by the sensor head!
- ▶ Make sure that the cable is not twisted.

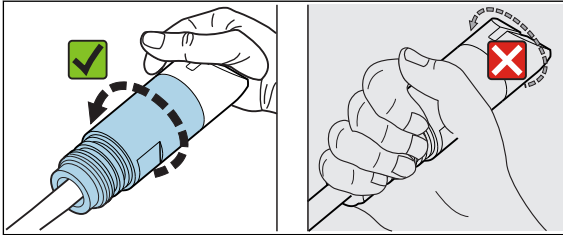

Hold the sensor head firmly in position and unscrew the sensor shaft from the sensor head.

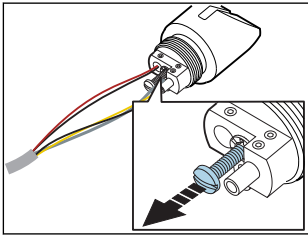
3.

Using a Phillips head screwdriver, release the securing screw of the lamp and detector unit.

4.

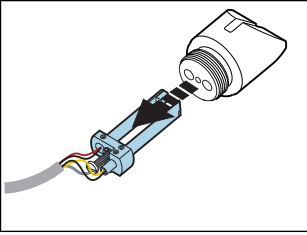

ⓘ If necessary, sever the cable tie on the sensor cable. There is a new cable tie in the spare parts kit which you can use to ensure strain relief on the cable once you re-insert the lamp and detector unit.

Remove the lamp and detector unit from the sensor head.



Sensor versions with Tri-Clamp or VARIVENT have one O-ring on either side of the process connection. Always replace the two O-rings.

5.

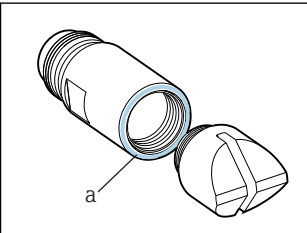

Release the O-ring (item a) from the guide in the sensor shaft.

6.

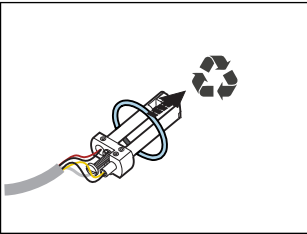

Pull the O-ring over the lamp and detector unit and dispose of it correctly.

7. **Without graphics:**

Push the new O-ring over the lamp and detector unit into the guide on the sensor shaft.

8. Re-install the lamp and detector unit. Tighten the securing screw slightly.

9. Mount the sensor again. ⓘ In doing so, use PTFE tape to seal the thread of the sensor head.

↳ Check the function of the sensor afterwards.

9 Repairs

9.1 Spare parts

Sensor spare parts

Description	Order number
Kit OUSAF11, incandescent lamp	71122199
Kit OUSAF11, 10mm lamp detector unit. NIR	71125626
Kit OUSAF11, 10mm lamp detector unit. VIS	71125627
Kit OUSAF11, 5mm lamp detector unit. NIR	71125628
KIT OUSAF11, 5mm lamp detector unit. VIS	71125629
Kit OUSAF11, 10mm sensor head	71122298
Kit OUSAF11, 5mm sensor head	71122299
Kit OUSAF11, cable gland	71122300

9.2 Return

The product must be returned if repairs or a factory calibration are required, or if the wrong product was ordered or delivered. As an ISO-certified company and also due to legal regulations, Endress+Hauser is obliged to follow certain procedures when handling any returned products that have been in contact with medium.

To ensure swift, safe and professional device returns, please read the return procedures and conditions at www.endress.com/support/return-material.

9.3 Disposal

The device contains electronic components and must therefore be disposed of in accordance with regulations on the disposal of electronic waste.

Observe the local regulations.

10 Accessories



The following are the most important accessories available at the time this documentation was issued. For accessories not listed here, please contact your service or sales office.

10.1 Assembly

Flexdip CYH112

- Modular holder system for sensors and assemblies in open basins, channels and tanks
- For Flexdip CYA112 water and wastewater assemblies
- Can be affixed anywhere: on the ground, on the capstone, on the wall or directly onto railings.
- Stainless steel version
- Product Configurator on the product page: www.endress.com/cyh112



Technical Information TI00430C

11 Technical data

11.1 Input

11.1.1 Measured variable

VIS/NIR absorption

11.1.2 Measuring range

- 0 to 3 AU
- 0 to 6 OD (depending on the optical path length)

11.1.3 Wavelength

NIR, broadband (VIS and NIR)

11.1.4 Optical path length

5 or 10 mm

11.2 Environment

11.2.1 Ambient temperature range

0 to 55 °C (32 to 130 °F)

11.2.2 Storage temperature

-10 to +70 °C (+10 to +160 °F)

11.2.3 Humidity

5 to 95 %

11.2.4 Degree of protection

IP 65 (NEMA 4) for all optical parts

11.3 Process

11.3.1 Process temperature

0 to 90 °C (32 to 194 °F) continuous

Max. 130 °C (266 °F) for 2 hours

11.3.2 Process pressure

Max. 10 bar (150 psi) absolute, at 20 °C (68 °F)

(For version with Tri-Clamp or VARIVENT process connection)

11.4 Mechanical construction

11.4.1 Dimensions

→  12

11.4.2 Weight

Approx. 0.8 kg (1.8 lbs)

11.4.3 Materials

Sensor head	FEP (Fluorinated ethylene propylene)
Sensor shaft	Stainless steel 316L
O-ring	EPDM
Cable connector ends	Nickel-plated brass

11.4.4 Process connections

Depends on version:

- Thread G1
- NPT 1" thread
- Tri-Clamp
 - 2"
 - 2.5"
 - 3"
- VARIVENT N DN40-125

11.4.5 Light source

Incandescent lamp

Lamp operating life: typically 10 000 h

11.4.6 Detector

VIS/NIR silicon detector, hermetically sealed

11.4.7 Filter

NIR or broadband filter, integrated in detector

Index

A

Accessories 23

C

Check

 Connection 16

 Installation 15

Cleaning 18

Connection

 Check 16

 Measuring device 15

D

Declaration of Conformity 10

Design 7

Designated use 6

Device description 7

Dimensions 12

Disposal 23

E

Ensuring the degree of protection 16

F

Function check 17

I

Incoming acceptance 9

Installation

 Check 15

Installation conditions 11

L

Lamp voltage 16

M

Maintenance schedule 17

Measured variable 24

Measuring principle 8

Measuring range 24

Measuring system 11

Mounting angles 12

Mounting the sensor 14

N

Nameplate 9

O

Occupational safety 6

Operational safety 6

P

Pipe mounting 13

Power supply

 Connecting the measuring device 15

Product identification 9

Product safety 7

R

Replacing

 Lamp 18

 O-ring 20

Requirements for the personnel 6

Return 23

S

Safety

 Occupational safety 6

 Operation 6

 Product 7

Safety instructions 6

Scope of delivery 10

Sensor

 Cleaning 18

Symbols 4, 5

T

Technical personnel 6

U

Use

 Designated 6

W

Warnings 4

Wavelength 24



71330142

www.addresses.endress.com
