

Operating Instructions

Fieldgate SFG500

Installation and commissioning

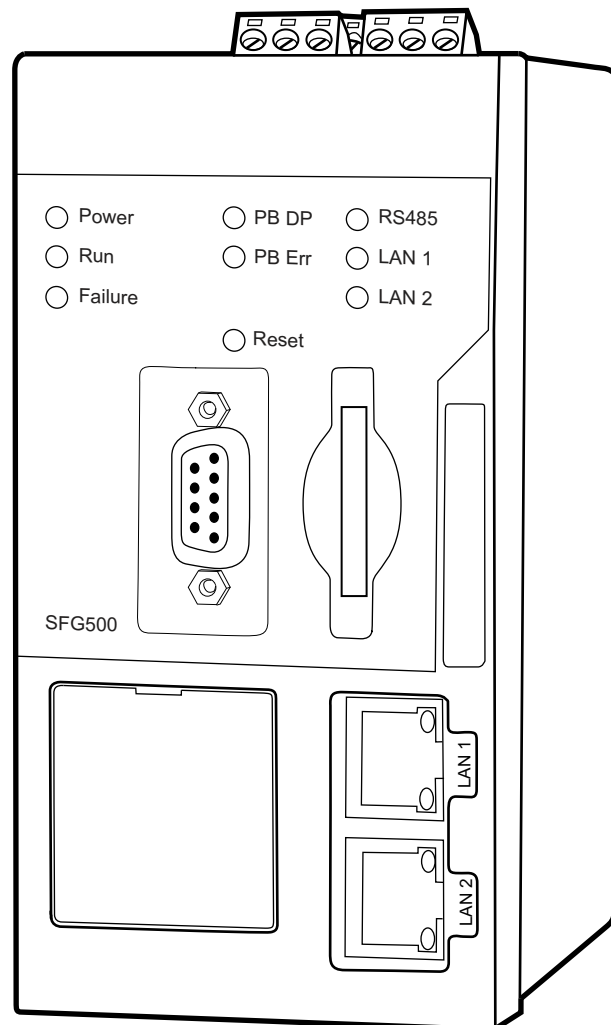

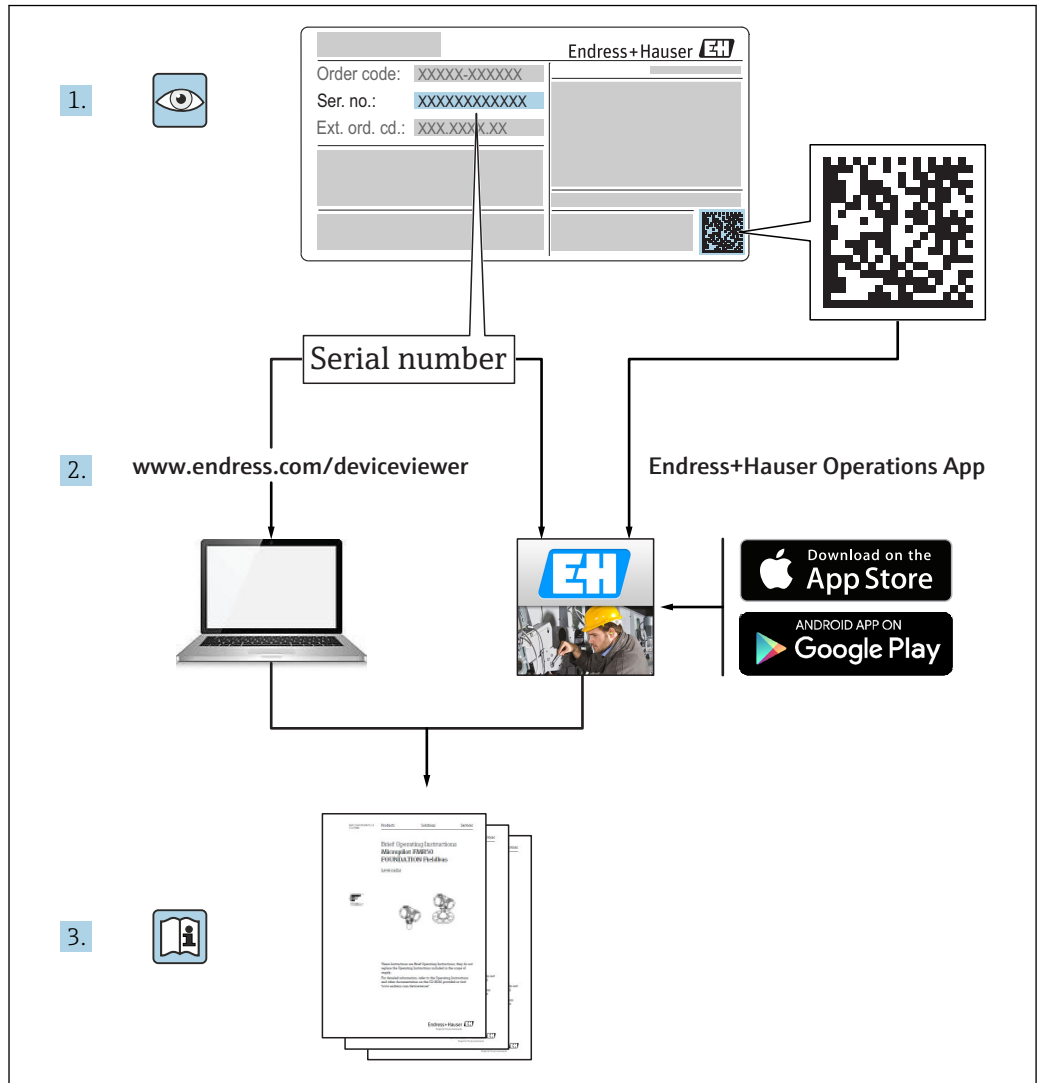

Revision history

Product version	Operating Instructions	changes	Comments
1.00.xx	BA00070S/04/en/01.11	Original manual	-
1.00.xx	BA00070S/04/en/02.12	Editorial Chapter 5 Editorial Chapter 6 + 9	Default LAN1 address = 10.126.84.100 Failure LED also flashes
1.01.xx	BA00070S/04/en/03.13	Chapter 7.2.2 General	Figure for card insertion Update with Asset Monitor ; new CD
1.02.xx	BA00070S/04/EN/04.14	Chapter 1 General	New, IT security Screenshots and texts updated
1.03.xx	BA00070S/04/EN/05.14	No change	-
1.04.xx	BA00070S/04/EN/06.14	No change	-
1.05.xx	BA00070S/04/EN/07.14	No change	-
1.06.xx	BA00070S/04/EN/08.15	No change	-
1.07.xx	BA00070S/04/EN/09.15	Chapter 7.2.6	Screenshots and texts updated
1.08.xx	BA00070S/04/EN/10.15	No change	-
1.09.xx	BA00070S/04/EN/11.16	New Content Management System	-
1.09.xx	BA00070S/04/EN/12.16	Section 2, Section 5, Section 6, Section 7, Section 8, Section 10	Modbus RS485 and relay output topics deleted

Table of contents

1	Document information	6	6.3	LEDs	19
1.1	Document function	6	6.4	LEDs on LAN socket	20
1.2	Symbols used	6	7	Commissioning	21
1.2.1	Safety symbols	6	7.1	Lithium battery	21
1.2.2	Symbols for certain types of information	6	7.2	Inserting the Fieldgate module SFM500	22
1.2.3	Electrical symbols	7	7.3	Connecting the computer	22
1.2.4	Type of protection	7	7.4	Wiring	23
1.3	Text emphasis	7	7.4.1	Interfaces and connectors	23
1.4	Supplementary documentation	7	7.4.2	Cable types	23
1.5	Acronyms used	8	7.5	Wiring diagrams	24
1.6	Registered trademarks	8	7.5.1	Supply voltage	24
2	Basic safety instructions	9	7.5.2	PROFIBUS DP	24
2.1	Requirements for the personnel	9	7.5.3	Ethernet LAN1 and LAN2	25
2.2	Designated use	9	8	Diagnostics and troubleshooting ...	26
2.3	Occupational safety	9	8.1	Faults indicated by the LEDs on the SFG500 ..	26
2.3.1	Hazardous areas	9	8.2	PROFIBUS communication faults	26
2.4	Operational safety	9	9	Repairs	27
2.5	Product safety	10	9.1	General notes	27
2.6	IT security	10	9.2	Spare parts	27
2.7	Declaration of Conformity	10	9.2.1	Replacement battery	27
2.8	Technical improvements	10	9.3	Return	27
3	Function and system design	11	9.4	Disposal	27
3.1	Function	11	10	Technical data	28
3.1.1	Web server	11	10.1	Output	28
3.2	System design	12	10.2	Digital communication interface	28
4	Incoming acceptance and product identification	13	10.2.1	PROFIBUS DP	28
4.1	Incoming acceptance	13	10.2.2	Ethernet (10 BASE-T/100 BASE TX)	28
4.1.1	Visual inspection	13	10.3	Supply voltage	28
4.1.2	Scope of delivery	13	10.4	Environment	29
4.2	Product identification	13	10.5	Mechanical construction	30
4.2.1	Fieldgate SFG500	13	10.6	Operation	30
4.2.2	Fieldgate module SFM500	14	10.7	Certificates and approvals	31
4.3	Storage and transport	15	11	Appendix	32
5	Installation	16	11.1	Appendix A - Computer IP settings	32
5.1	DIN rail clip	16	Index	34	
5.2	Rack mounting	16			
5.2.1	Location	16			
5.2.2	Installation	17			
5.3	Installation	17			
5.3.1	Hardware configuration	17			
5.3.2	Installing the Fieldgate SFG500	18			
6	Operation options	19			
6.1	Reset button	19			
6.2	Card slot	19			





1 Document information

1.1 Document function











These Operating Instructions contain all the information that is required in various phases of the life cycle of the device: from product identification, incoming acceptance and storage, to mounting, connection, operation and commissioning through to troubleshooting, maintenance and disposal.

1.2 Symbols used







1.2.1 Safety symbols

Symbol	Meaning
	DANGER! This symbol alerts you to a dangerous situation. Failure to avoid this situation will result in serious or fatal injury.
	WARNING! This symbol alerts you to a dangerous situation. Failure to avoid this situation can result in serious or fatal injury.
	CAUTION! This symbol alerts you to a dangerous situation. Failure to avoid this situation can result in minor or medium injury.
	NOTE! This symbol contains information on procedures and other facts which do not result in personal injury.



1.2.2 Symbols for certain types of information

Symbol	Meaning
	Permitted Indicates procedures, processes or actions that are permitted.
	Preferred Indicates procedures, processes or actions that are preferred.
	Forbidden Indicates procedures, processes or actions that are forbidden.
	Tip Indicates additional information.
	Reference to documentation Refers to the corresponding device documentation.
	Reference to page Refers to the corresponding page number.
	Reference to graphic Refers to the corresponding graphic number and page number.
	Series of steps
	Result of a sequence of actions
	Help in the event of a problem

1.2.3 Electrical symbols

Symbol	Meaning
 A0011197	Direct current A terminal to which DC voltage is applied or through which direct current flows.
 A0011198	Alternating current A terminal to which alternating voltage is applied or through which alternating current flows.
 A0017381	Direct current and alternating current <ul style="list-style-type: none"> ▪ A terminal to which alternating voltage or DC voltage is applied. ▪ A terminal through which alternating current or direct current flows.
 A0011200	Ground connection A grounded terminal which, as far as the operator is concerned, is grounded via a grounding system.
 A0011199	Protective ground connection A terminal which must be connected to ground prior to establishing any other connections.
 A0011201	Equipotential connection A connection that has to be connected to the plant grounding system: This may be a potential equalization line or a star grounding system depending on national or company codes of practice.

1.2.4 Type of protection

Symbol	Meaning
	Explosion-proof equipment which has undergone type examination If the device has this symbol embossed on its name plate it can be installed in an explosion hazardous area in accordance with the specifications in the certificate or in a safe area.
	Hazardous area Symbol used in drawings to indicate explosion hazardous areas. Devices located in and wiring entering areas with the designation "explosion hazardous areas" must conform with the stated type of protection.
	Safe area (non-hazardous area) Symbol used in drawings to indicate, if necessary, non-explosion hazardous areas. Devices located in safe areas still require a certificate if their outputs run into explosion hazardous areas.

1.3 Text emphasis

Emphasis	Meaning	Example
Bold	Keys, buttons, program icons, tabs, menus, commands	Start → Programs → Endress+Hauser select Print option in the File menu.

1.4 Supplementary documentation

The following table lists the documents, both existing and planned, that contain information relevant to safety or instructions for the installation, commissioning and operation of the Fieldgate SFG500 and its web server. The manual PROFIBUS guidelines contains information on how to design and install a PROFIBUS network, in particular on how to ground the network in order to avoid electromagnetic interference on the bus. All documentation available at the time of release is included on the Fieldgate SFG500 CD-

ROM and is installed under **Start → Programs → Endress+Hauser SFG500 → Manuals** during setup.

SFG500 documentation

Description	Document type	Description
Fieldgate SFG500; Access Point, Asset Monitor, Process Monitor	Operating Instructions	BA01579S/04/EN
Fieldgate SFG500; Getting Started	Operating Instructions	BA00073S/04/A2
PROFIBUS Guidelines	Operating Instructions	BA00034S/04/EN

1.5 Acronyms used

Acronyms	Meaning
CAN/CSA	Canadian Standard Association
DC circuits	Direct current circuits
DCS	Distributed Control System
DHCP Server	Dynamic Host Configuration Protocol Server
DIN	German Standards Institute
DP	Decentralized Peripheral
IEC	International Electrotechnical Commission
I/O	Input/Output
LAN	Local Area Network
MAC	Media Access Control
TÜV NRTL	Nationally Recognized Testing Laboratory
PA	Process Automation
PLC	Programmable Logic Controller
DCS	Distributed Control System
PROFIBUS	Process Field Bus
SELV	Safety Extra Low Voltage
PLC	Programmable Logic Controller

1.6 Registered trademarks

PROFIBUS® is a registered trademark of the PROFIBUS User Organization, Karlsruhe/Germany.

Microsoft®, Windows®, Windows 2000®, Windows XP®, Windows 2003 Server®, Windows 2008 Server®, Windows 7®, Windows Vista® and the Microsoft logo are registered trademarks of the Microsoft Corporation.

Acrobat Reader® is a registered trade mark of Adobe Systems Incorporated.

All other brand and product names are trademarks or registered trademarks of the companies and organizations in question.

2 Basic safety instructions

2.1 Requirements for the personnel

The system must be installed, connected, configured, operated and maintained in accordance with the instructions in this manual and the associated manuals. In addition, the operating personal must have the necessary authorizations and appropriate qualifications.

2.2 Designated use

Fieldgate SFG500 is a system component that provides an independent access route to a PROFIBUS network. It may be used in a variety of applications that are supported by specific operating modes. The operating modes are determined by an optional memory card (Fieldgate module SFM500).

Without memory card, Fieldgate SFG500 has the basic operating mode Access Point. In this case, it acts as an Ethernet gateway with adaptive PROFIBUS Master Class 2 capabilities to support FDT-based plant asset management host applications, e.g. FieldCare. Applications that require a memory card are being developed and will be described in separate manuals, see **Section 1.4** →  7.

2.3 Occupational safety

Fieldgate SFG500 must be mounted in a permanent and weather-protected location in a safe area. A metal cabinet or an installation frame with a well-grounded mounting plane is recommended.

The Fieldgate SFG500 can be operated at altitudes of up to 2 000 m (6 500 ft).

2.3.1 Hazardous areas

Fieldgate SFG500 is not approved for use in hazardous areas. If it is connected to networks that are used in hazardous areas, barriers or other safety components must be used. In general, note the following when installing components in hazardous areas:

- Ensure that all installation and maintenance personnel are suitably qualified
- Check that all the system components have the appropriate safety certificates
- Comply with the specifications in the device safety certificates and with all national and local regulations





 This topic is discussed in **BA034S/04/en** (PROFIBUS Guidelines).



2.4 Operational safety

Fieldgate SFG500 has been designed to operate safely in accordance with current technical safety and EU directives. Field devices, links, junction boxes, cables and other hardware used in conjunction with the Fieldgate SFG500 module must also be designed to operate safely in accordance with current technical safety and EU directives.

If devices are installed incorrectly or used for applications for which they are not intended, or if the Fieldgate SFG500 module is not configured correctly, it is possible that dangers may arise.

2.5 Product safety

- Before switching on the device, check that the supply voltage of the SFG500 matches that of the power-supplying SELV power unit. The device may not be switched on if this is not the case. The characteristic data of the SFG500 are provided on the nameplate, see **Section 4.2.1** →  13 or **Section 10** →  28.
- Only use spare parts and accessories supplied with the device or approved by Endress+Hauser. The use of accessories and spare parts which have not been approved can impair the device function considerably and put the safety of the user at risk. The parts included in the scope of delivery are described in **Section 4.1.2** →  13 and genuine spare parts are described in **Section 9.2** →  27.
- The Fieldgate SFG500 is designed for installation on a standard DIN rail. Make sure that the requirements for electrical safety in accordance with IEC 61010-1 are met when the Fieldgate is in the final application position.
- Safe operation of the Fieldgate SFG500 is no longer possible if:
 - the housing has been damaged (e.g. as a result of excessive mechanical stress)
 - water has entered the device interior
 - objects have entered the device interior through the air vents
 - smoke is coming from inside the device
 - the power supply line is damaged
 - another situation has arisen that prevents the correct operation of the device

 Immediately disconnect the SELV power unit from the mains so that all the DC circuits (for device power supply and relays) are voltage-free and contact Customer Service immediately. (See **Section 9** →  27).

We wish to expressly advise you that product liability and warranty claims cannot be asserted if the Fieldgate SFG500 is not operated in accordance with the instructions in these Operating Instructions, the instructions on the device itself or if it is not used as intended.

2.6 IT security

We only provide a warranty if the device is installed and used as described in the Operating Instructions. The device is equipped with security mechanisms to protect it against any inadvertent changes to the device settings.

IT security measures in line with operators' security standards and designed to provide additional protection for the device and device data transfer must be implemented by the operators themselves.

2.7 Declaration of Conformity

The Fieldgate SFG500 meets the requirements of TÜV NRTL for multi-purpose use in North America, CAN/CSA C22.2-No 61010-1, UL61010-1 and bears the CE mark. Endress+Hauser confirms that the Fieldgate SFG500 meets all the legal requirements of the relevant EU directives by affixing to it the CE mark. The relevant standards are:

- IEC 61010-1: Safety requirements for electrical equipment for measurement, control and laboratory use; Part 1: General requirements
- IEC 61131-2: Programmable controllers; Part 2: Equipment requirements and tests

2.8 Technical improvements

Endress+Hauser reserves the right to make technical improvements to the software and devices at any time and without prior notification. Wherever such improvements do not affect the operation of the device, they are not documented. If the improvements affect operation, a new version of the Operating Instructions will always be created.

3 Function and system design

3.1 Function

Fieldgate SFG500 has been designed as a Class 2 Master for use in a PROFIBUS system operated by a PLC or a number of PLCs in a virtual token ring. The PLC can operate both as a Class 1 and Class 2 Master and other Class 2 Masters can temporarily **visit** the system. In this role, the Fieldgate SFG500 offers parallel access to PROFIBUS DP segments for Ethernet-based applications.

When started, the Fieldgate SFG500 connects to PROFIBUS and automatically starts listening to the traffic, if any, on the bus: it has no effect on the traffic itself, however. In this way, the device automatically detects and applies the most appropriate settings for operation as a Master Class 2. The selected settings are displayed and saved in the integrated Web server.

If the Fieldgate SFG500 is used as an Access Point, the host application (e.g. FieldCare) can now be programmed for this in order to use the connection for communication with the devices on the bus, see **BA01579S/04/en** .

3.1.1 Web server

When the Fieldgate SFG500 starts, the bus is scanned automatically. The results are compiled into a live list which can be viewed in the integrated Web server. The list contains all devices on the PROFIBUS DP segment to which the Fieldgate SFG500 is connected and all transparently coupled PROFIBUS PA devices.

The Web server offers the following functionalities in the Access Point mode:

- Configuration of the Fieldgate IP address
- Visualization and, if necessary, configuration of the PROFIBUS parameters
- Display of Fieldgate SFG500 information
- Update of Fieldgate SFG500 firmware

 A description of the other Fieldgate SFG500 operating modes can be found in the corresponding Operating Instructions.

3.2 System design

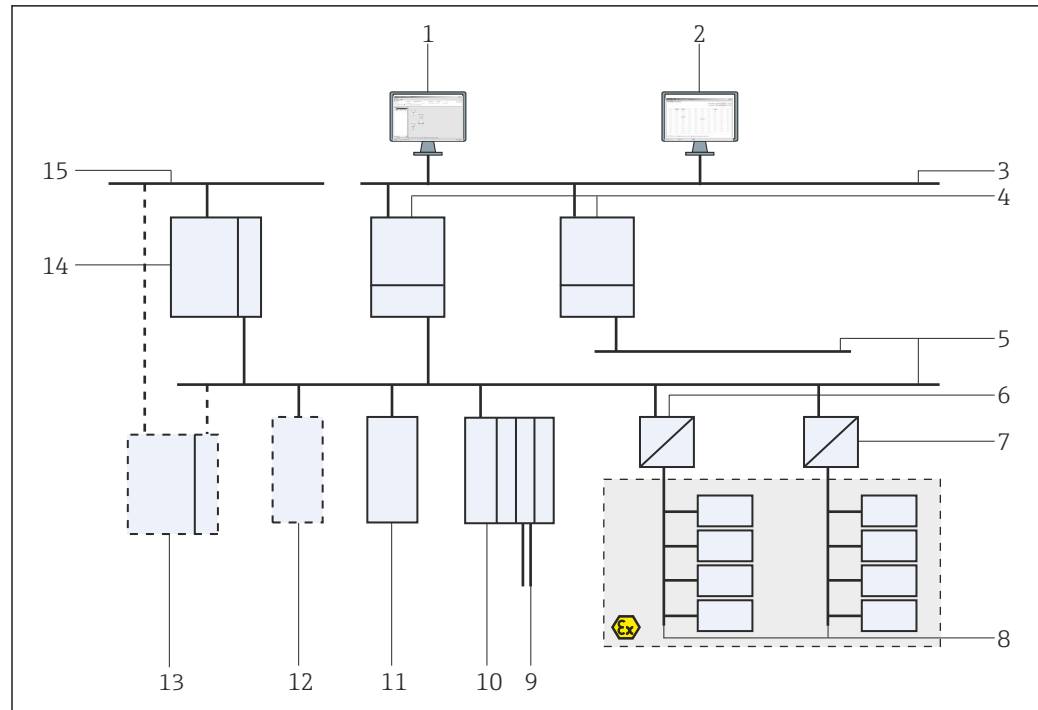

1 System architecture for SFG500 PROFIBUS operating as an access point or plant asset monitor

- 1 FieldCare
- 2 Web browser
- 3 LAN 1 (Ethernet)
- 4 SFG500 Listener PB MS2
- 5 PROFIBUS DP
- 6 DP/PA coupler (transparent)
- 7 DP/PA coupler (not transparent)
- 8 PROFIBUS PA with PA slave
- 9 HART devices downstream from remote I/O
- 10 DP remote I/O (HART connection)
- 11 DP slave (PA profile)
- 12 PB Class 2 master (visitor)
- 13 PLC/DCS (additional PB Class 1 master optional)
- 14 PLC/DCS with PB Class 1 master
- 15 Control network

A typical control network consists of a PLC or DCS system and one or more PROFIBUS DP segments. Depending on the actual circumstances, it is possible for additional Class 1 masters to be connected to the network. PROFIBUS DP slaves, remote I/Os and segment couplers or links are also connected to the PROFIBUS DP segment. Remote I/Os enable HART devices to be integrated into the PROFIBUS DP network, for example. Segment couplers or links establish a connection to PROFIBUS PA slaves and also supply them with power.

The LAN in which these devices operate can be a separate network or a part of the control network. The Fieldgate SFG500 connects to one PROFIBUS DP segment only. If there is more than one segment in a PROFIBUS DP network, a separate Fieldgate SFG500 is required for each segment.

The Fieldgate SFG500 can be configured by a Web browser (e.g. Internet Explorer) from any computer in the local area network (LAN) or locally via its second Ethernet port (LAN2). In the latter case, the Fieldgate's DHCP server supplies an IP address to the connected computer.

4 Incoming acceptance and product identification

4.1 Incoming acceptance

4.1.1 Visual inspection

- Check the packaging for visible damage arising from transportation
- To avoid damage, remove the packaging with care
- Keep the original packaging in case you need to transport the device
- Retain all the accompanying documents

The device may not be put into operation if the contents are found to be damaged beforehand. In this case, contact the Endress+Hauser Sales Center. Return the device to Endress+Hauser in the original packaging.

4.1.2 Scope of delivery

Before commencing commissioning, check that the delivery is complete and undamaged.

- Fieldgate SFG500
- Getting Started Guide
- CD-ROM with DTM and documentation

 The Fieldgate module SFM500 can be delivered separately if necessary.

4.2 Product identification

4.2.1 Fieldgate SFG500

The Fieldgate SFG500 can be identified from the designation on the front panel and the nameplate on the side. For clarity the nameplate is shown with a white background in this document. The actual nameplate on the device has white printing on a black background.

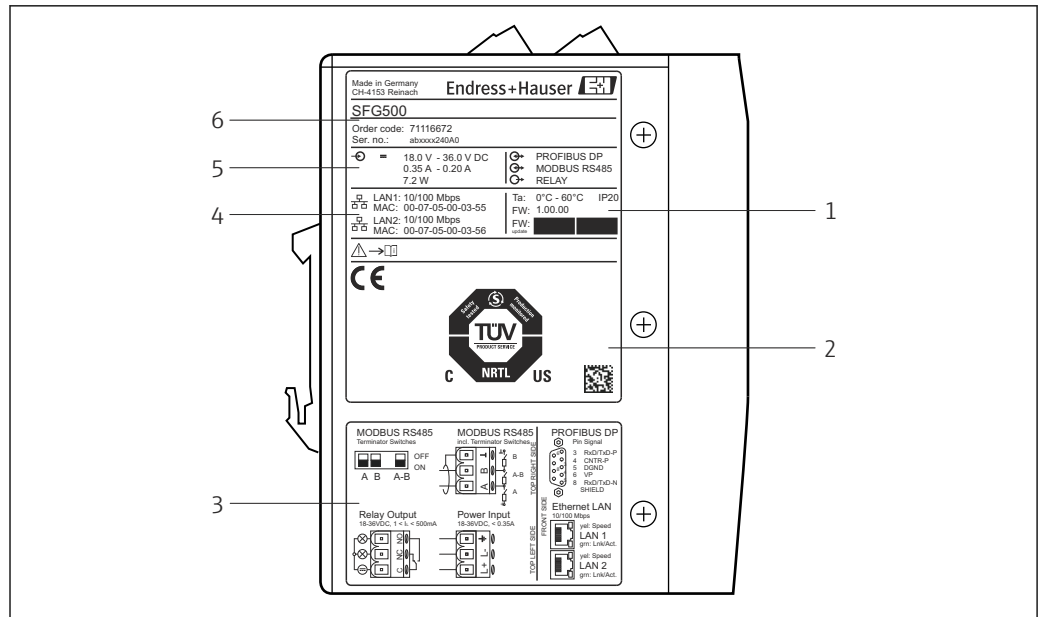

2 Identification of the Fieldgate SFG500

- 1 Ambient temperature, IP protection, firmware
- 2 TÜV NRTL multi-purpose mark, 2D Data Matrix code (serial number)
- 3 Wiring and connection diagrams
- 4 MAC address for LAN1 and LAN2
- 5 Voltage, current consumption and power
- 6 Identification, order code and serial number

4.2.2 Fieldgate module SFM500

The Fieldgate module SFM500 can be identified from the designation on the nameplate.

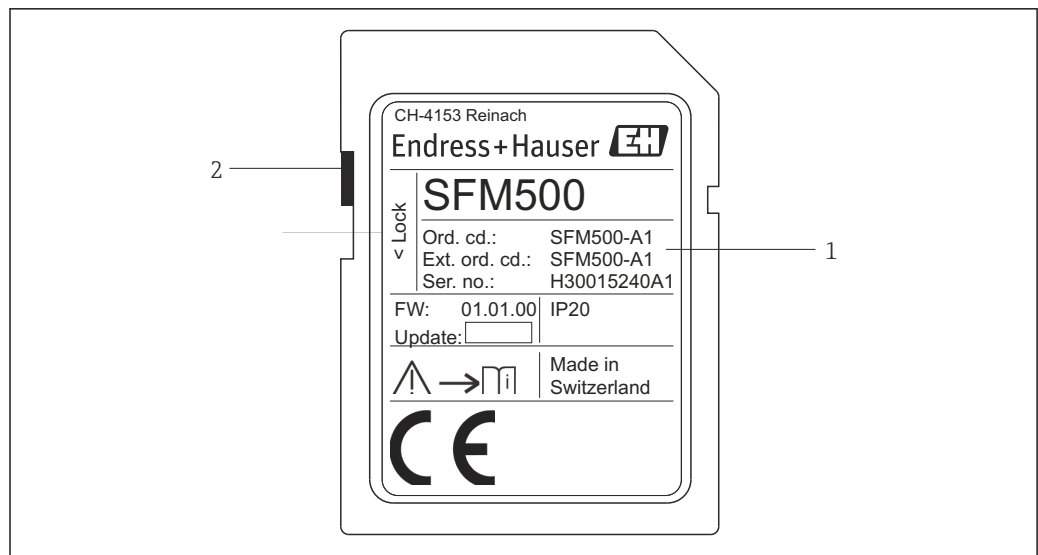

3 Identification of the Fieldgate module SFM500

- 1 Identification, order code and serial number
- 2 Write protection switch (off: unlocked, as illustrated; on: locked)

The supported functions can be derived from the order code as follows:

SFM Fieldgate module	
Operating mode	
A1	Asset Monitor
SFM500	Product structure

4.3 Storage and transport

Always store and transport the device in the original packaging. Always store the device in a clean and dry environment. Observe the permitted storage temperature, see **Section 10.4** →  29.

5 Installation

⚠ WARNING

Failure to ensure that the layout of the mounted and wired components in a cabinet complies with in-house and national regulations and standards concerning the separation of Ex and non-Ex components and circuits and the separation of signal cables and power cables.

Loss of approval for Ex and non-Ex components.

- ▶ Installation must be carried out by properly trained, expert staff.

i Components in a cabinet must be mounted and wired as stipulated by in-house and national regulations and standards.

5.1 DIN rail clip

Fieldgate SFG500 has a clip on the back of the housing which is used for fixing the module to a standard DIN rail. The clip can be fixed at two positions.

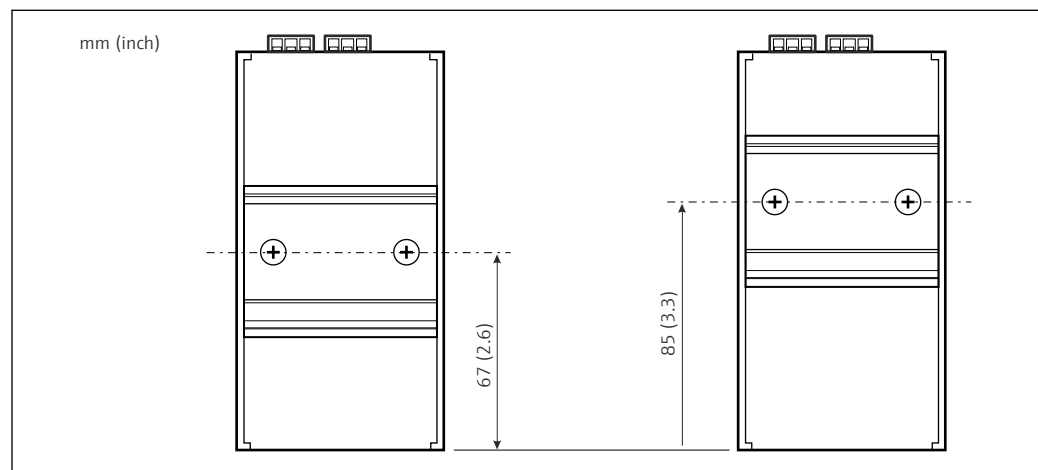

4 DIN rail clip positioned at half the height of the housing in relation to the bottom of the model

To change the position of the clip, simply release the two Phillips screws, fix the clip at the new position and tighten the two screws again so that the clip is firmly seated. Changing the position of the clip lowers the position of the top of the module by 18 mm when mounted on a DIN rail.

5.2 Rack mounting

5.2.1 Location

The Fieldgate SFG500 is designed for use in a permanent and weather-protected location. The installation environment should be a metal cabinet or an installation frame with a well-grounded mounting plate. The environment should be protected.

The graphic shows the principle dimensions of the Fieldgate SFG500 when mounted on a DIN rail, with the clip mounted in the central position (as-delivered state).

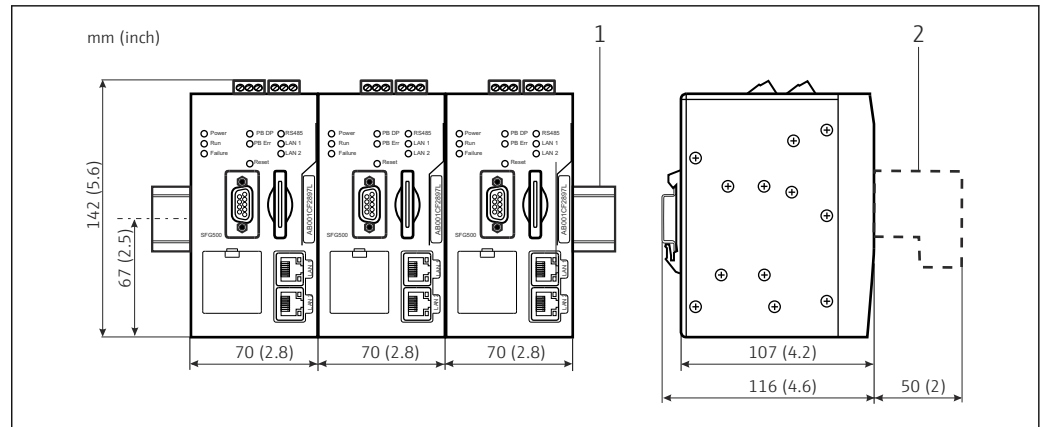

5 General dimensions of rack-mounted SFG500 (clip in central position)

1 Top-hat rail (not supplied)

2 Necessary clearance for DP or Ethernet connection (not supplied)

5.2.2 Installation

The Fieldgate SFG500 is designed to be installed vertically on a DIN rail. Comply with the following guidelines to ensure correct operation:

- i Comply with the following guidelines to ensure correct operation:
 - The Fieldgate SFG500 does not require lateral clearance from other modules and can therefore be mounted directly beside every other non-Ex module
 - To ensure adequate ventilation and prevent overheating, the **lateral** clearance between the modules and the cabinet duct or cabinet wall must be at least 50 mm
 - To ensure adequate ventilation and prevent overheating, the **vertical** clearance between the modules and the cabinet duct or cabinet wall must be at least 50 mm

5.3 Installation

5.3.1 Hardware configuration

- i Modbus RS485 is not used in the **Access Point** or **Asset Monitor** mode.

The Fieldgate SFG500 must be configured before it is mounted on the DIN rail. There is a DIP switch on the top of the module. This switch can be accessed with a small screwdriver blade and controls the terminating resistance of the RS485 interface.

5.3.2 Installing the Fieldgate SFG500

Mounting the Fieldgate SFG500

Once the DIP switches have been set, the Fieldgate SFG500 can be mounted on the DIN rail.

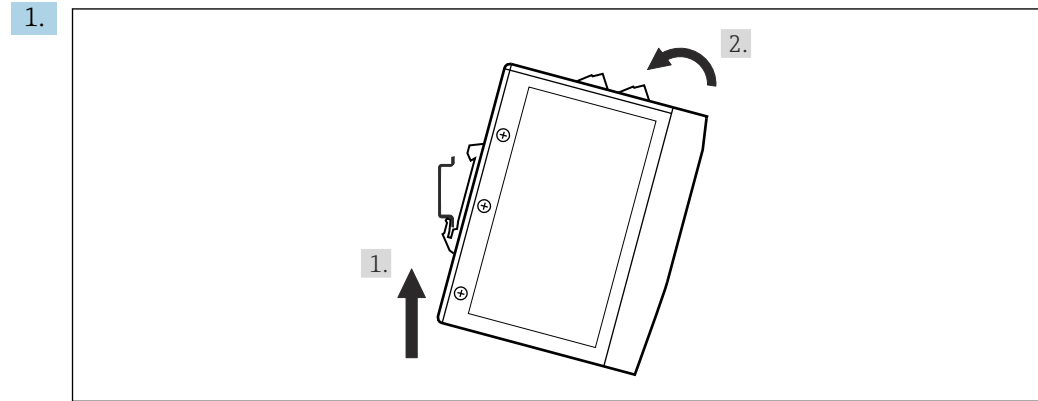

Holding the device at a 15° angle to the rack, slot it into the bottom of the DIN rail.

2. Push the device up and then gently press the top down until it engages in the top of the DIN rail.

The device is mounted on the DIN rail.

Removing the Fieldgate SFG500

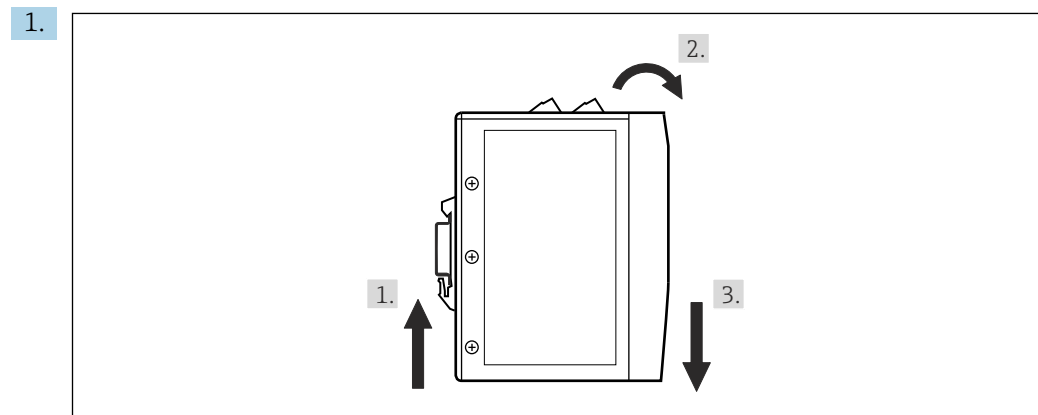

Push the device up.

2. Tilt it 15°.
3. Pull it downwards to remove it from the DIN rail.

The device can be removed from the DIN rail.

6 Operation options

All the display and operating elements are located on the front of the device.

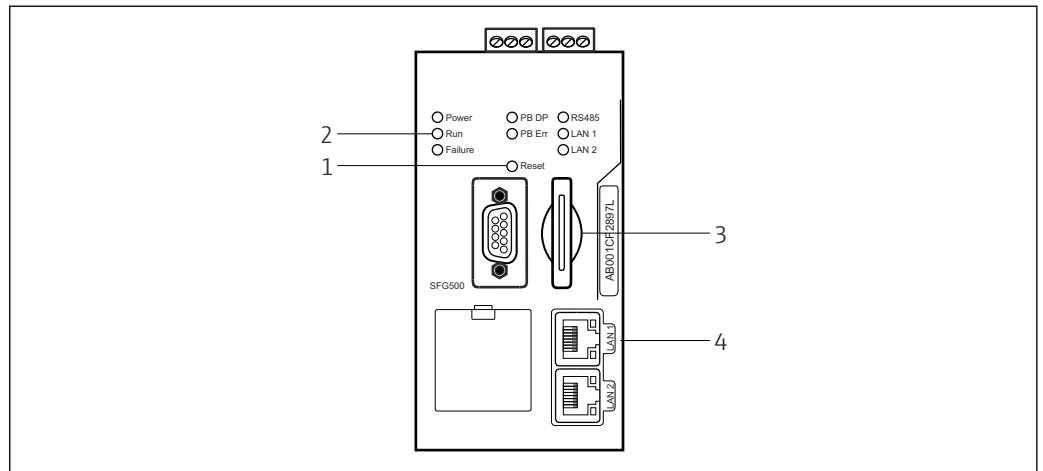

6 Communication interface and connectors of the Fieldgate SFG500

- 1 Reset button
- 2 LEDs on SFG500
- 3 Card slot
- 4 LEDs on LAN socket

Duration	Function	Description
>4.5 s	Hardware reset	Restarts the system (takes approx. 1 min) <ul style="list-style-type: none"> ▪ The Failure LED lights up and all other LEDs go out ▪ The Power LED lights up ▪ All LEDs light up briefly and then return to their normal mode, see Section 6.3 → 19.

6.1 Reset button

The reset button is located in a 3 mm opening in the front panel. It is in a recess around 6 mm deep and can be operated using a 2.5 mm (#0) screwdriver or similar object.

6.2 Card slot

The slot for the Fieldgate module SFM500 is located on the front panel of the device. If the Fieldgate SFG500 is used as an Access Point, no card (Fieldgate module SFM500) is supplied. For all other applications, e.g. use as an Asset Monitor and Process Monitor, a card is supplied as part of the delivery. It should be inserted by hand during commissioning, see **Section 7.2** → 22.

6.3 LEDs

i Modbus RS485 is not used in the **Access Point** or **Asset Monitor** mode.

Following a system start (power cycle or reset) all the LEDs are lit for approx. 2.5 seconds before they assume their normal mode as described in the table below. The Power LED assumes its normal mode immediately. The function of the LEDs depends on whether the

Fieldgate SFG500 is used as a Class 2 Master (Plant Access Point and Plant Asset Monitor) or a Class 1 Master (special applications).

LED	Color	Mode	Meaning
Power	Green	On	The device is connected to the power supply and is ready for operation
		Off	No power supply
Run	Yellow	On	Normal operation according to the operating mode
		Flashes	During startup, Fieldgate SFG500 is booted
		Off	Problem
Failure	Red	On	Critical problems in CPU module and the program memory is defective
		Flashes	Critical problems in CPU module and the program memory is defective
		Off	Device OK
PB DP	Yellow	On	Fieldgate SFG500 is passive; listening to bus traffic
		Flashes	Fieldgate SFG500 is active; accessing bus as Master Class 1/2
		Off	Connection or communication error
PB Err	Red	On	Permanent bus error <ul style="list-style-type: none"> ▪ Bus not connected ▪ No communication
		Off	No PROFIBUS error
LAN1 port	Yellow	On	A network cable is connected but no data exchange is taking place
		Flashes	The application is receiving and transmitting messages via LAN1
		Off	No network cable connected to LAN1
LAN2 port	Yellow	On	A network cable is connected but no data exchange is taking place
		Flashes	The application is receiving and transmitting messages via LAN2
		Off	<ul style="list-style-type: none"> ▪ No network cable connected to LAN2 ▪ Connected PC has not accepted the address from the DHCP server

6.4 LEDs on LAN socket

The LAN sockets have two LEDs which indicate the communication status.

Color	Mode	Function
Yellow	On	Speed 100 Mbit/s
	Off	Speed 10 Mbit/s
Green	On/flashing	Connection/activity
	Off	No connection

7 Commissioning

7.1 Lithium battery

NOTICE

The positive pole of the inserted battery points to the rear.
The real-time clock stops running and a device failure can result.

- ▶ Insert the battery correctly.

NOTICE

Isolating strip removed incorrectly.

The real-time clock stops running and a device failure can result.

- ▶ When the SFG500 is delivered, the lithium battery is correctly inserted but isolated by a plastic strip to prevent it from discharging. This strip must be removed by trained personnel before the Fieldgate SFG500 can be used.

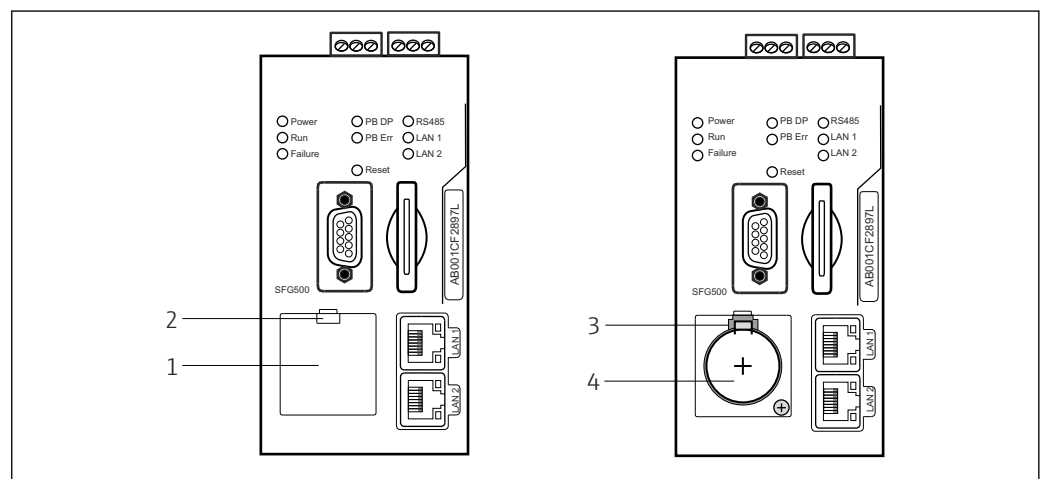

7 Battery compartment with and without cover

- 1 Battery compartment lid
- 2 Latch
- 3 Retaining catch
- 4 Lithium battery

1. Press down the latch on the upper edge of the lid using your finger or a suitable tool (screwdriver).
 - ↳ The battery compartment can be opened.
2. Press the retaining catch gently upwards while simultaneously gently pressing the battery towards the front.
 - ↳ The battery can be released with a screwdriver.
3. Carefully remove the battery from its compartment and remove the isolating strip.
4. Place the battery on the lower edge of the battery compartment such that the positive pole points to the front, and gently press the battery back into the compartment.
 - ↳ The catch engages.
5. Place the battery compartment cover onto the recess on the front panel and close the battery compartment.

7.2 Inserting the Fieldgate module SFM500

NOTICE

Fieldgate module SFM500 inserted incorrectly.

Licensing and application data corrupted.

- ▶ The Fieldgate SFG500 can only be inserted and removed in a de-energized state.

i When inserting the Fieldgate module SFM500 make sure that it is inserted perpendicular to the device.

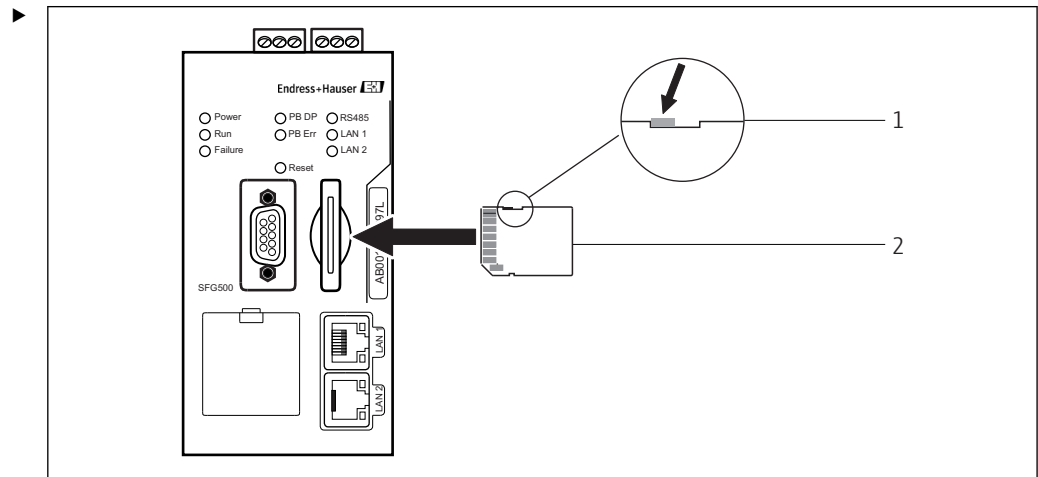

8 Inserting the Fieldgate module SFM500

- 1 SFM500 unlocked
- 2 Fieldgate SFM500

Unlock the Fieldgate module and insert into the Fieldgate SFG500.

7.3 Connecting the computer

i This section describes how to connect the Fieldgate SFG500 to the computer via LAN2. Information on how to connect via LAN1 is described in **BA01579S/04/EN**.

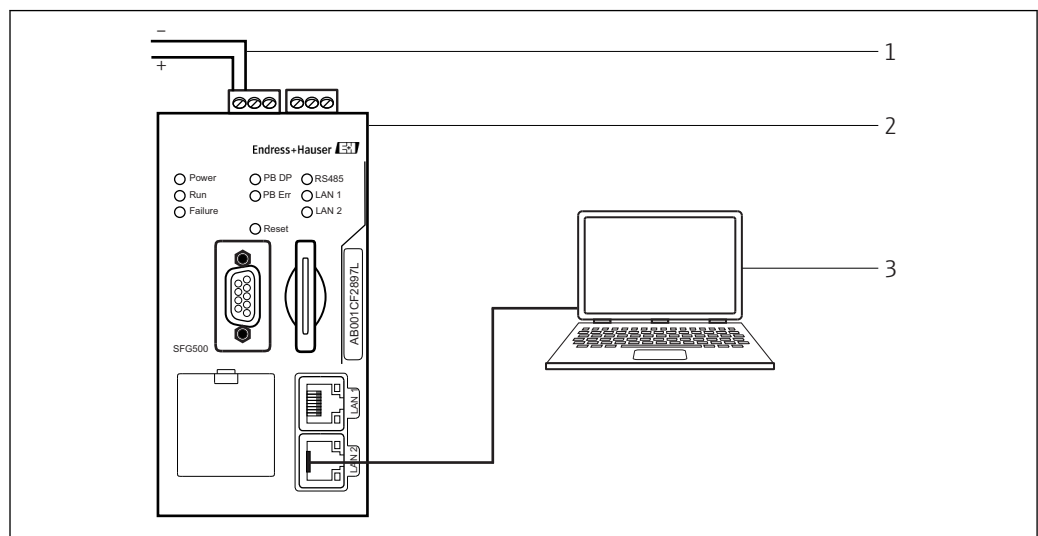

9 Connecting the computer to the Fieldgate SFG500

1. Supply voltage to the Fieldgate SFG500.
 - ↳ The Fieldgate is ready for operation and the yellow RUN-LED is continuously lit.

2. Connect the laptop to the LAN2 port of the Fieldgate SFG500.

The connection to the Web server can be established.

7.4 Wiring

7.4.1 Interfaces and connectors

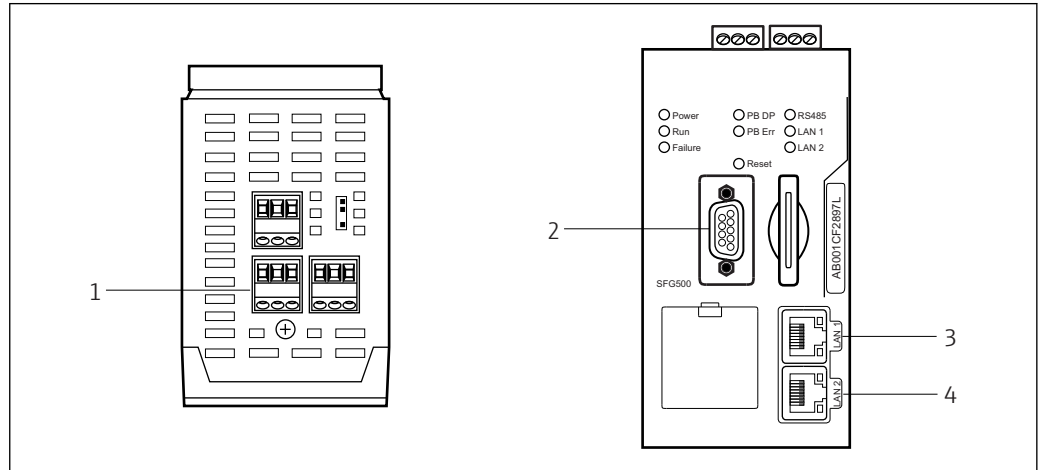

10 Communication interfaces and connectors of Fieldgate SFG500

- 1 Power connection (green)
- 2 PROFIBUS DP
- 3 Ethernet LAN1 (operation)
- 4 Ethernet LAN2 (service)

7.4.2 Cable types

The connector and the cable types to be used for the various connectors are listed in the following table:

Interface/connector	Connector type	Cable type	Comments
Power connection	Screw terminals	Standard installation	Max. cross-section 2.5 mm ²
PROFIBUS DP	9-pin DIN Sub-Min D	PROFIBUS DP cable	Commercially available PROFIBUS-DP plug-in connectors are recommended
Ethernet LAN1	RJ-45 socket	CAT5e, shielded	Standard cable set, patch or crossover, recommended
Ethernet LAN2	RJ-45 socket	CAT5e, shielded	Standard cable set, patch or crossover, recommended

The screw terminal blocks can be removed from the module to make wiring easier.

Standard PROFIBUS cables are available from a number of cable manufacturers. Commercially available PROFIBUS DP connectors often support daisy-chaining, can be mounted piggy-back and have a switchable terminal resistor.

The Ethernet ports of the Fieldgate SFG500 can be used with a crossover or patch cable, depending on whether a connection is made point-to-point or via a switch.

7.5 Wiring diagrams

NOTICE

Short-circuit when wiring the interfaces.

Damage to the device.

- ▶ Always switch off the power supply to the device first of all.

7.5.1 Supply voltage

CAUTION

The connected voltage is higher than 24 V.

This will damage the device.

- ▶ The power may only be connected by qualified and trained personnel.

i The Fieldgate SFG500 has reverse polarity protection so the device is not damaged if the wiring is incorrect.

The Fieldgate SFG500 requires a voltage of 24 V_{DC} (18 to 36 V_{DC}) and draws a maximum current of 350 mA. The power must be provided by a SELV power unit and the power circuit should include an isolating switch.

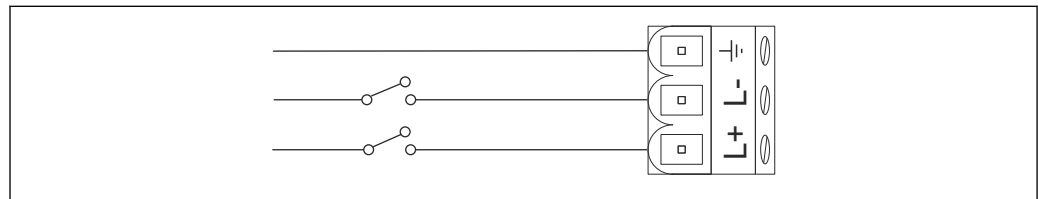

11 Wiring diagram for current input

Terminal designation	Function
≡	Functional earth
L-	0 V _{DC}
L+	24 V _{DC}

7.5.2 PROFIBUS DP

i General information on the length, design, shielding and grounding of PROFIBUS DP segments can be taken from the PROFIBUS Guidelines (**BA034S/04/en**).

The 9-pin DIN Sub-Min D female connector for PROFIBUS DP connection is located on the front of the module. It is advisable to use commercially available PROFIBUS DP plug-in connectors since they allow simple assembly and termination. If the Fieldgate SFG500 is the first or last device on the bus, the terminator must be enabled.

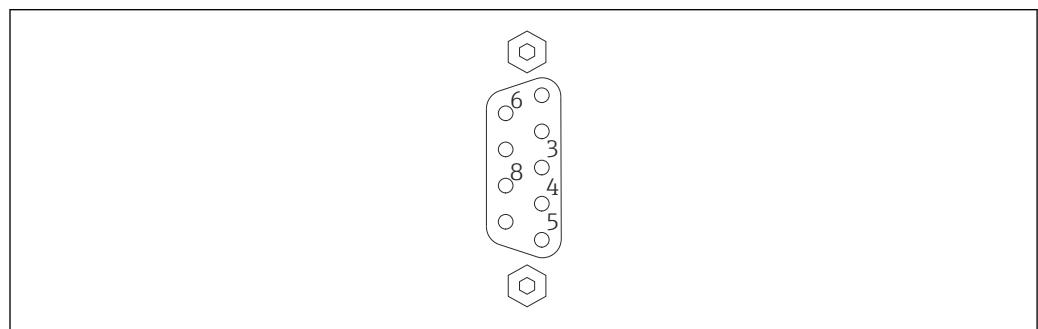

12 PROFIBUS DP 9-pin female connector

Pin assignment

Pin	Signal	Function
1	NC	Not connected
2	NC	Not connected
3	RxD/TxD-P	Non-inverting bus line
4	DP_CNTR	Drive enable
5	DP_GND	Isolated ground
6	DP_VCC	VCC (5 V) max. 40 mA
7	NC	Not connected
8	RxD/TxD-P	Inverting bus line
9	NC	Not connected
M1, M2	SHIELD	DGND/FE

7.5.3 Ethernet LAN1 and LAN2

The Ethernet RJ-45 female connector on the front of the module. There are two ports labeled LAN1 and LAN2, which are used for operation and service respectively. It is recommended that connections be made with CAT5e Ethernet cables (crossover or patch cables, depending on the connection).

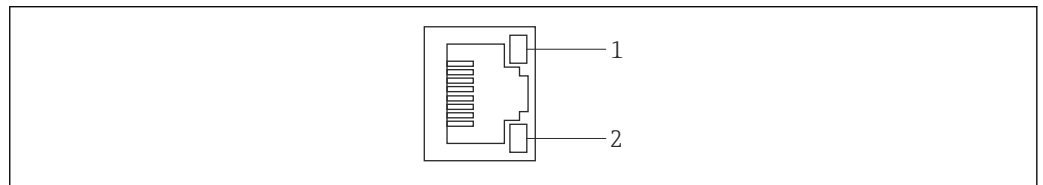

 13 Ethernet RJ-45 female connector

- 1 Yellow LED: speed
- 2 Green LED: active connection

Pin assignment of Ethernet RJ-45 female connector

Pin	Signal	Function
1	1 ETH*_TX+	Transmit +
2	1 ETH*_TX-	Transmit -
3	1 ETH*_RX+	Receive +
4	Termplane	→ 75R, AC coupling to FE
5	Termplane	Connected to Pin 4
6	ETH*_RX-	Receive -
7	Termplane	→ 75R, AC coupling to FE
8	Termplane	Connected to Pin 7
*LAN1=1; LAN2=2		

8 Diagnostics and troubleshooting

8.1 Faults indicated by the LEDs on the SFG500

Problem	Cause/Remedy
The Power LED is not lit.	No power: <ul style="list-style-type: none"> ▪ Check to ensure that the power cable is correctly wired ▪ Check to ensure that the supply voltage corresponds to the voltage indicated on the nameplate ▪ Check to ensure that the power is switched on ▪ Application of a supply voltage that is too high for the device causes the internal fuse to blow Return the Fieldgate SFG500 to Endress+Hauser for repair
The Failure LED is lit or flashing.	There is a serious problem in the CPU or the device is unable to start up <ul style="list-style-type: none"> ▪ Switch off the power supply, wait 30 seconds, then switch it back on again ▪ If the Failure LED is still lit: Return the Fieldgate SFG500 to Endress+Hauser for repair
The PB Err LED is lit.	PROFIBUS network has malfunctioned: <ul style="list-style-type: none"> ▪ Check to ensure that the bus has the correct terminations (on both ends) ▪ Check to ensure that all of the master bus parameters are identical ▪ Check to ensure that the bus is wired correctly
The LAN1 or LAN2 LED is switched off even though the interface is wired.	Wiring or link error: <ul style="list-style-type: none"> ▪ Check the wiring ▪ Check to ensure that the communication partner is switched on ▪ Check to ensure that the IP address has been set properly: <ul style="list-style-type: none"> – LAN1: Fixed IP address in the network domain – LAN2: Address is assigned by DHCP

8.2 PROFIBUS communication faults

Problem	Cause/Remedy
The Fieldgate SFG500 cannot establish a connection to the PROFIBUS DP segment.	Wiring or link error: <ul style="list-style-type: none"> ▪ Check to ensure that the PROFIBUS DP segment has the correct terminations (at both ends). ▪ Check the wiring ▪ Check to ensure that there are not two instances of the same station address ▪ Check to ensure that all of the master bus parameters are identical If necessary, adjust the Token Rotation Time
A device does not appear in the live list.	Communication error: <ul style="list-style-type: none"> ▪ Another device has the same address ▪ The device was not started up ▪ The device does not support automatic detection of the baud rate Set the correct baud rate <ul style="list-style-type: none"> ▪ The device is connected to a link that is not transparent (normal behavior)

9 Repairs

9.1 General notes

The national requirements regarding the maintenance, servicing, and inspection of an associated apparatus apply. No maintenance other than that described in this chapter is necessary if the devices are operated properly, observing the installation instructions and ambient conditions. The devices may not be repaired, modified or manipulated. If there is a defect, the product must always be replaced with an original part.



Contact addresses can be found on our homepage at www.endress.com/worldwide. If you have any questions, please contact your Endress+Hauser office.

9.2 Spare parts

9.2.1 Replacement battery

The replacement battery must be a lithium manganese dioxide battery, type CR2450, with the following specifications:

- Operating temperature range: -20 to +85 °C (-4 to +178 °F)
- Nominal voltage: 3 V
- Nominal capacity: 610 mAh
- Max. current: 15 mA
- UL approval

 The battery must be replaced by appropriately trained staff after a maximum period of 5 years, see **Section 7.1** →  21

9.3 Return

The Fieldgate SFG500 must be returned if it is in need of repair, or if the wrong device has been delivered or ordered. As an ISO-certified company and also due to legal regulations, Endress+Hauser is obliged to follow certain procedures when handling any returned products that have been in contact with medium. To ensure swift, safe and professional device returns, please read the return procedures and conditions on the Endress+Hauser website at www.services.endress.com/return-material.

9.4 Disposal

It is essential to dispose of the Fieldgate SFG500, the lithium battery and the Fieldgate module SFM500 in accordance with applicable national regulations and standards.

10 Technical data

10.1 Output

Output type	Relay (not supported for Access Point and Asset Monitor)
Arrangement	Single changeover contact
Supply voltage	18 to 36 V _{DC} : The relay circuit must be powered by a SELV power unit.
Load current	1 mA < I _L < 0.5 A
Max. switching capacity	18 W
Coil to contact dielectric strength	Min. 1 500 V _{AC} for 1 minute
Type of protection	None
Galvanic isolation	Fully isolated from all other circuits
Connections	<ul style="list-style-type: none"> ▪ Terminal block with 3 terminals ▪ Screw terminals: 0.2 to 4 mm² for solid wire, 0.2 to 2.5 mm² for stranded wire

10.2 Digital communication interface

10.2.1 PROFIBUS DP

Protocol	PROFIBUS DP
Transmission rate	<ul style="list-style-type: none"> ▪ Automatic detection and matching of system baudrate ▪ Can also be configured via Web server or FDT/DTM
Type of protection	None
Galvanic isolation	Fully isolated from all other circuits
Max. bus length	1 200 m depending on cable and transmission rate
Input variables	<ul style="list-style-type: none"> ▪ All variables of connected PROFIBUS DP devices ▪ All variables of PROFIBUS PA devices connected via a DP/PA coupler or link ▪ All variables of HART devices connected to selected remote I/Os
Connections	9-pin D-sub female connector

10.2.2 Ethernet (10 BASE-T/100 BASE TX)

Ports	LAN1 for operation, LAN2 for service
Protocol	LAN1 can be configured for Ethernet TCP/IP communication
Transmission rate	Choice of 10 ¹⁰⁰ Mbit/s (max. cable length 100 m at 25 °C ambient temperature)
Type of protection	None
Galvanic isolation	Fully isolated from all other circuits
Max. bus length	100 m depending on cable
Connections	RJ-45 socket

10.3 Supply voltage

Supply voltage	18 to 36 V _{DC} : supply voltage must be via a SELV power unit
Current	0.35 to 0.20 A

Capacity	7.2 W
Connections	<ul style="list-style-type: none"> ▪ Terminal block with 3 terminals ▪ Screw terminals: 0.2 to 4 mm² for solid wire, 0.2 to 2.5 mm² for stranded wire
Battery (for memory)	<p>3 V lithium manganese dioxide battery, type CR2450:</p> <ul style="list-style-type: none"> ▪ Operating temperature range: -20 to 85 °C (-4 to 178 °F) ▪ Nominal voltage: 3 V ▪ Nominal capacity: 610 mA ▪ Max. current: 15 mA ▪ UL approval: e.g. MH12568

10.4 Environment

Ambient temperature range	0 to 60 °C (32 to 140 °F)
Storage temperature	<ul style="list-style-type: none"> ▪ With lithium battery inserted: -20 to 60 °C (-4 to 140 °F) ▪ Without lithium battery inserted: -25 to 70 °C (-13 to 158 °F)
Relative humidity	10 to 90 %, no condensate; for operation and storage
Altitude	Max. 2 000 m (6 500 ft)
Vibration resistance	EN/IEC 61131-2:2007: 5 to 8.4 Hz: 3.5 mm; 8.4 to 150 Hz: 10 ms ⁻²
Shock resistance	EN/IEC 61131-2:2007: 15 g, 11 ms
Electromagnetic compatibility	<p>Meets EU Directive 2004/108/EC on Electromagnetic compatibility: Electromagnetic compatibility according to EN/IEC 61131-2: 2007 (programmable logic controllers)</p> <ul style="list-style-type: none"> - Interference immunity: EN 61000-6-2:2006, industrial environment - Interference emission: EN 61000-6-4:2007
Mean time between failure	<ul style="list-style-type: none"> ▪ 15 years at an ambient temperature of 25 °C (77 °F) The battery must be replaced every five years ▪ The relay contact depends on the number of switching events ▪ All connectors are designed for a minimum of 100 plugging cycles

10.5 Mechanical construction

<p>Dimensions</p> <p>mm (inch)</p>	<p>B x H x D: 142 mm x 70 mm x 114 mm (5.6" x 2.8" x 4.5")</p>
<p>Weight</p>	<p>Approx. 0.7 kg</p>
<p>Material</p>	<ul style="list-style-type: none"> ■ Body: aluminum (EN AW 5754) with transparent passivated surface ■ Front panel: ABS
<p>Degree of protection</p>	<p>IP 20; NEMA Type 1 (general purpose)</p>
<p>Type of protection</p>	<p>None</p>
<p>Operational safety</p>	<p>IEC 61010-1: Class III equipment</p>

10.6 Operation

<p>Operating modes</p>	<p>Access Point, Asset Monitor, Process Monitor A Fieldgate module is required for the Asset Monitor and Process Monitor modes</p>
<p>Configuration</p>	<p>Web browser via Ethernet</p>
<p>Operating elements</p>	<ul style="list-style-type: none"> ■ 1x reset button for interrupting operation or resetting the hardware ■ 8x LEDs for indicating the current operating mode and fault conditions ■ 4x LEDs at Ethernet ports for indicating the communication status
<p>IP address</p>	<ul style="list-style-type: none"> ■ LAN1: can be configured via the Web browser or FDT/DTM, default 10.126.84.100 ■ LAN2: fixed, 192.168.253.1 ■ LAN2 has a DHCP server which assigns an address to a connected computer

10.7 Certificates and approvals

CE mark	CE in accordance with EN/IEC 61131-2: 2007
Safety approval	TÜV NRTL in accordance with EN/IEC/UL/CAN/CSA C22.2-No 61010-1

11 Appendix

11.1 Appendix A - Computer IP settings

-  Administrator rights might be needed to be able to change the IP settings of the computer. If this is the case, please contact your system administrator.
- The procedure described in this chapter refers to Windows XP. Please contact your system administrator for other Windows systems.

Most computers which are used in a company network will already be set up to accept an IP address from a DHCP server. If the computer is used in a control system, however, it is possible that it has a fixed address. If this is the case, please proceed as follows:

Procedure for Windows XP

1. Click **Start** → **Settings** → **Control Panel** → **Network Connections**.
↳ The **Network Connections** dialog will open.

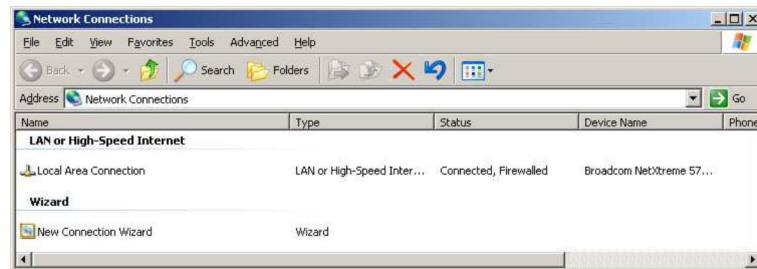

2. Right-click the **LAN Connection** → **Properties** tab.
↳ This will open the **Local Area Connection Properties** dialog.

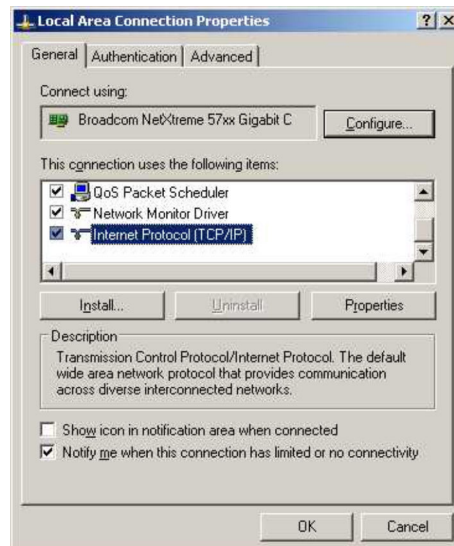

3. Double-click **Internet Protocol (TCP/IP)**.
↳ This will open the **Internet Protocol Properties (TCP/IP)** dialog.

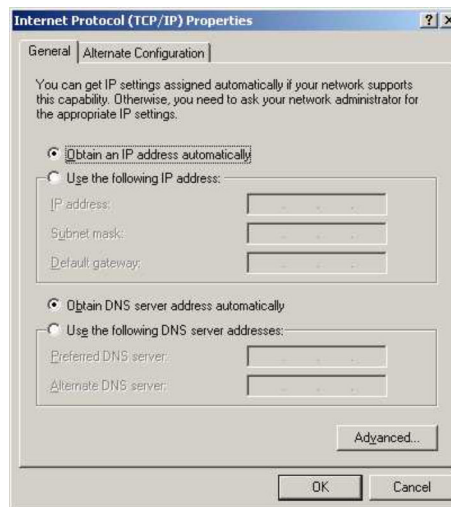

4. Note the addresses that have been assigned to the computer. You will need them later if the computer is reset after commissioning the SFG500.
5. Click **Obtain an IP Address Automatically**.
6. Click **OK**.
↳ Your selection is confirmed and the **Internet Protocol Properties (TCP/IP)** dialog is closed.
7. Click **OK**.
↳ This will close the **Local Area Connection Properties** dialog.

Once the Fieldgate SFG500 has been set up, the computer can be reset to its original IP address as described below:

Resetting the fixed IP address

1. Repeat steps 1-3 of the procedure above.
2. In the **Internet Protocol Properties (TCP/IP)** dialog, select the **Use the Following IP Address** option.
3. Enter the settings you noted down in step 4.
4. Click **OK**.
↳ Your selection is confirmed and the **Internet Protocol Properties (TCP/IP)** dialog is closed.
5. Click **OK**.
↳ This will close the **Local Area Connection Properties** dialog.

Index

B

Battery 21, 27

C

Cable type 23

Commissioning 21

D

Disposal 27

Documentation 7

E

Electrical symbols 6

Environment 29

Ethernet 25, 28

F

Fieldgate module SFM500 14, 22

Fieldgate SFG500 13

I

Installation 16, 17

Interfaces and connectors 23

IP settings 32

L

LEDs 19

P

PROFIBUS 24, 26, 28

R

Reset button 19

S

Safety instructions 9

Safety symbols 6

Scope of delivery 13

Storage and transport 15

Supply voltage 28

T

Technical data 28

W

Web server 11

www.addresses.endress.com
