

Operating Instructions

EngyVolt RV15

Multifunction electrical energy meter

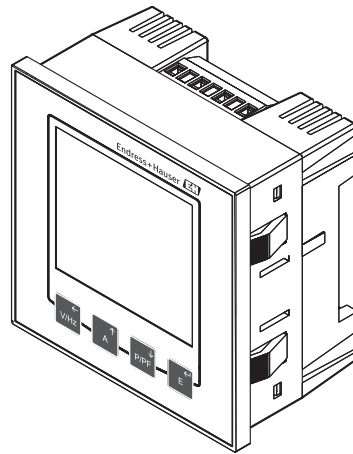

Table of contents

1	Safety instructions	4	11	Appendix	38
1.1	Workplace safety	4	11.1	Basis of measurement and calculations	38
1.2	Requirements concerning the staff	4	11.2	Modbus implementation	39
1.3	Operational safety	4	11.3	RS485 general information	45
1.4	Designated use	4	11.4	Modbus protocol general information	48
1.5	Technical improvement	5	11.5	RS485 Implementation of Johnson Controls Metasys	60
1.6	Return	5			
1.7	Notes on safety conventions and icons	5			
2	Identification	7			
2.1	Device designation	7			
2.2	Scope of delivery	7			
2.3	Certificates and approvals	7			
3	Installation	9			
3.1	Incoming acceptance, transport, storage	9			
3.2	Installation conditions	9			
3.3	Dimensions	9			
3.4	Installation instructions	10			
3.5	Post-installation check	11			
4	Wiring	12			
4.1	Supply voltage	12			
4.2	Electrical connection	12			
4.3	Connecting the outputs	15			
4.4	Post-connection check	16			
5	Operation	18			
5.1	Display	18			
5.2	Operating elements	18			
5.3	Display mode	18			
5.4	Configuration mode	19			
5.5	Power-up screen	20			
6	Commissioning	21			
6.1	Post-installation check and switching on the device	21			
6.2	Menu structure	21			
6.3	Device settings	23			
7	Maintenance	28			
8	Troubleshooting	29			
8.1	Spare parts	29			
8.2	Return	29			
8.3	Disposal	29			
9	Accessories	30			
10	Technical data	31			
				Index	64

1 Safety instructions

The reliable and safe operation of the device is only ensured if the user reads these Operating Instructions and complies with the safety instructions they contain.

1.1 Workplace safety

For work on and with the device:

- ▶ Wear the required personal protective equipment according to federal/national regulations.

1.2 Requirements concerning the staff

The personnel for installation, commissioning, diagnostics and maintenance must fulfill the following requirements:

- ▶ Trained, qualified specialists: must have a relevant qualification for this specific function and task
- ▶ Are authorized by the plant owner/operator
- ▶ Are familiar with federal/national regulations
- ▶ Before beginning work, the specialist staff must have read and understood the instructions in the Operating Instructions and supplementary documentation as well as in the certificates (depending on the application)
- ▶ Following instructions and basic conditions

The operating personnel must fulfill the following requirements:

- ▶ Being instructed and authorized according to the requirements of the task by the facility's owner-operator
- ▶ Following the instructions in these Operating Instructions

1.3 Operational safety

Risk of injury.

- ▶ Operate the device in proper technical condition and fail-safe condition only.
- ▶ The operator is responsible for interference-free operation of the device.

Conversions to the device

Unauthorized modifications to the device are not permitted and can lead to unforeseeable dangers.

- ▶ If, despite this, modifications are required, consult with Endress+Hauser.

Repair

To ensure continued operational safety and reliability,

- ▶ Carry out repairs on the device only if they are expressly permitted.
- ▶ Observe federal/national regulations pertaining to repair of an electrical device.
- ▶ Use original spare parts and accessories from Endress+Hauser only.

Environmental requirements

If a plastic transmitter housing is permanently exposed to certain steam and air mixtures, this can damage the housing.

- ▶ If you are unsure, please contact your Endress+Hauser Sales Center for clarification.
- ▶ If used in an approval-related area, observe the information on the nameplate.

1.4 Designated use

The multifunction electrical energy meter is designed to record, display and transmit electrical measured values in low-voltage systems with a maximum nominal voltage of

500 V L-L (289 V L/N), power connection via low-voltage current transformer x/5A at a nominal frequency of 45 to 66 Hz. It is suitable for use in single-phase power systems, and in three-phase power systems with three or four wires.

Among other values, the electrical energy meter measures the voltage, frequency, current, power, power factor, total harmonic distortion (THD) as well as imported and exported active energy and reactive energy.

- The manufacturer accepts no liability for damages resulting from incorrect use or use other than that designated. It is not permitted to convert or modify the device in any way.
- The device is designed for installation in a panel and must only be operated in an installed state.

1.5 Technical improvement

The manufacturer reserves the right to modify technical data without prior notice. Please contact your sales center for information on modifications or updates to the Operating Instructions.

1.6 Return

The device must be packed in protective packaging if it is being returned for repair, for example. The original packaging offers the best protection. Repairs may only be performed by your supplier's service organization.

-  When returning the device for repair, enclose a note with a description of the problem and the application.

1.7 Notes on safety conventions and icons

1.7.1 Warnings

DANGER

Causes (/consequences)

Consequences of non-compliance (if applicable)

- ▶ Corrective action
- ▶ This symbol alerts you to a dangerous situation. Failure to avoid the situation will result in a fatal or serious injury.

WARNING

Causes (/consequences)

Consequences of non-compliance (if applicable)

- ▶ Corrective action
- ▶ This symbol alerts you to a dangerous situation. Failure to avoid the situation can result in a fatal or serious injury.

CAUTION

Causes (/consequences)

Consequences of non-compliance (if applicable)







- ▶ Corrective action
- ▶ This symbol alerts you to a dangerous situation. Failure to avoid this situation can result in minor or more serious injuries.

NOTICE**Causes (/consequences)**

Consequences of non-compliance (if applicable)

- ▶ Corrective action
- ▶ This symbol alerts you to situations which may result in damage to property.

1.7.2 Document symbols

	Permitted Indicates procedures, processes or actions that are permitted.
	Preferred Indicates procedures, processes or actions that are preferred.
	Forbidden Indicates procedures, processes or actions that are forbidden.
	Additional information, tips
	Reference to documentation
	Reference to a page in this manual
	Reference to a graphic

2 Identification

2.1 Device designation

2.1.1 Nameplate

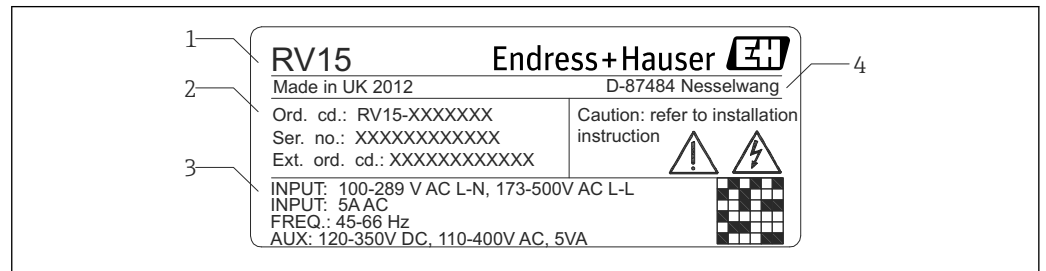

1 Nameplate EngyVolt RV15 (example)

- 1 Device designation
- 2 Order code, serial number and extended order code of the device
- 3 Input variable and auxiliary power supply
- 4 Year of manufacture and manufacturer address

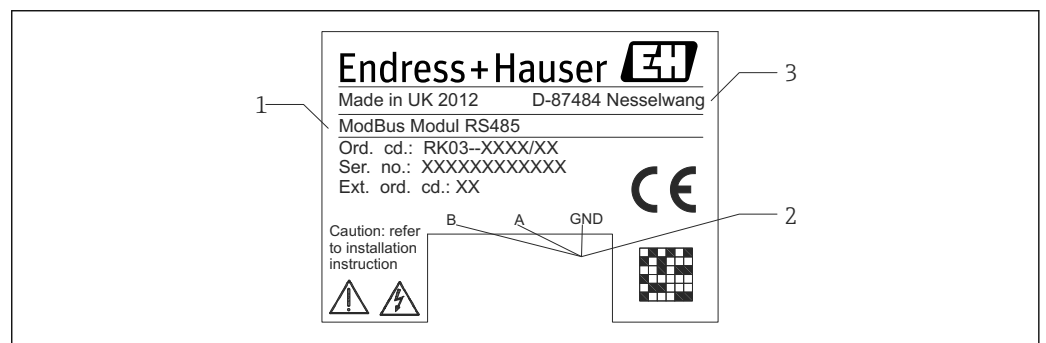

2 Nameplate EngyVolt RV15 extension module (example)

- 1 Module designation, order code, serial number
- 2 Terminals
- 3 Year of manufacture and manufacturer address

2.2 Scope of delivery

The scope of delivery comprises:

- Multifunction electrical energy meter for panel mounting
- Brief Operating Instructions

2.3 Certificates and approvals

2.3.1 CE mark, declaration of conformity

The device is designed to meet state-of-the-art safety requirements, has been tested and left the factory in a condition in which it is safe to operate. The device meets the relevant standards and directives as per EN 61 010-1 "Safety requirements for electrical equipment for measurement, control and laboratory use".

Thus, the device described in these Operating Instructions meets the legal requirements for the EU directives. The manufacturer confirms successful testing of the device by affixing to it the CE mark.

For an overview of all available certificates and approvals, refer to the "Technical data" chapter.

3 Installation

3.1 Incoming acceptance, transport, storage

Compliance with the permitted storage and transportation conditions is mandatory. Precise specifications are provided in the "Technical data" section (→ 31).

3.1.1 Incoming acceptance

On receipt of the goods, check the following points:

- Is the packaging or the content damaged?
- Is the delivery complete? Compare the scope of delivery against the information on your order form.

3.1.2 Transport and storage

Please note the following:

Pack the device so that is protected against impact for storage and transport. The original packaging provides optimum protection.

3.2 Installation conditions

Measuring devices must be mounted in a dry location at stable ambient temperatures that do not exceed or drop below the range of -10 to 55 °C (14 to 131 °F). There should be minimum tension from vibrations. If possible, the measuring device should be mounted in such a way that the contrast of the display is not affected by direct sunlight or strong lighting. The LCD display is optimized for vertical reading. If the display is read horizontally, lighting conditions can affect the readability of the display. The measuring device can be installed in any panel cutout according to DIN 96 with a maximum thickness of up to 5 mm (0.2 in). When mounting, make sure there is sufficient room to connect cables and wires on all sides of the measuring device. The front of the measuring device is suitable for use with IP52 protection.

3.3 Dimensions

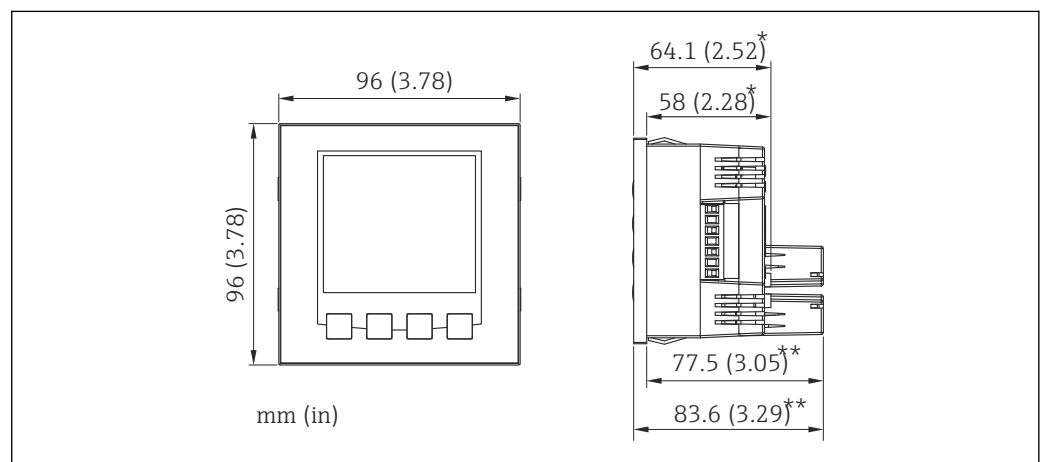

3 Device dimensions

* without extension modules

** with extension modules

A0016361

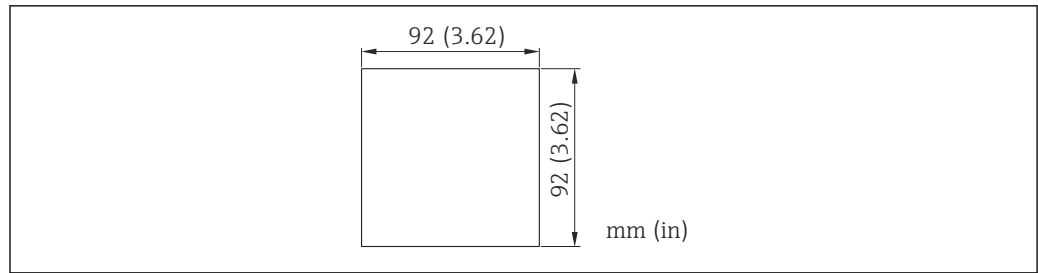

A0016362

4 Dimensions for panel cutout

3.4 Installation instructions

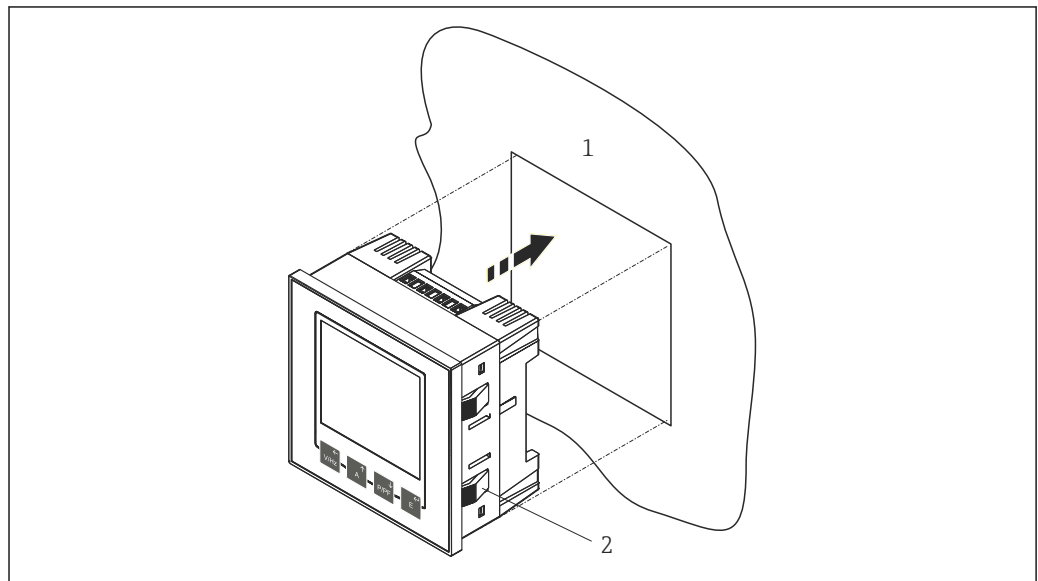

A0016512

5 Panel mounting of the EngyVolt RV15

- 1 Panel with requisite cutout
- 2 Integrated snap-on fastener

1. Create the panel cutout with the necessary dimensions (→ 4, 10).
2. Push the device into the panel cutout from the front until the snap-on fastener which is integrated in the housing locks into place.

3.4.1 Installation of extension modules

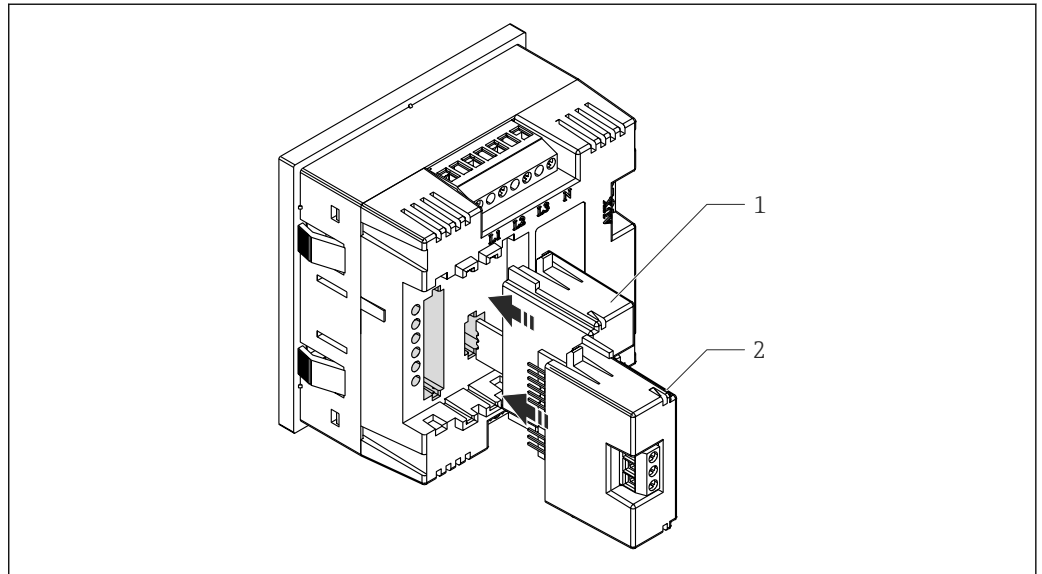

6 Installation of extension modules

- 1 Pulse extension module
- 2 RS485 / pulse extension module

3.5 Post-installation check

- Is the device located in the center of the panel cutout?
- Are the integrated snap-on fasteners locked in place?
- Is there enough room for the cable connections?

4 Wiring

⚠ WARNING

Danger! Electric voltage!

- ▶ The entire electrical connection must be performed when the device is de-energized.
- ▶ Establish the protective ground connection before making any other connections.

NOTICE

Cable heat load

- ▶ Use suitable cables for temperatures that are 5 °C (9 °F) above the ambient temperature.

Incorrect supply voltage can damage the device or cause malfunctions

- ▶ Before commissioning the device, make sure that the supply voltage matches the voltage specifications on the nameplate.

Incorrect wiring can damage the device

- ▶ Observe the terminal designations on the device.

Electrical overloading can damage the device

- ▶ Provide overcurrent protection elements for the power cables.
- ▶ Provide a suitable switch or power-circuit breaker for emergency shutdown in building installations. This switch must be provided close to the device (within easy reach) and marked as a circuit breaker.

4.1 Supply voltage

The supply voltage is designed for the range from 100 to 400 V AC and 120 to 350 V DC. Preferably, the supply voltage should be provided from a source other than the measured voltage. The measured voltage can be used if it is within the tolerance limits of the supply voltage.

4.2 Electrical connection

The terminals are located on the back of the housing.

To ensure maximum accuracy, we recommend that the current signal connecting cables pass through additional ferrite cores (e.g. of type 742 701 110 from Würth Elektronik) at least six times.

4.2.1 Connection in single-phase, 2-wire power network

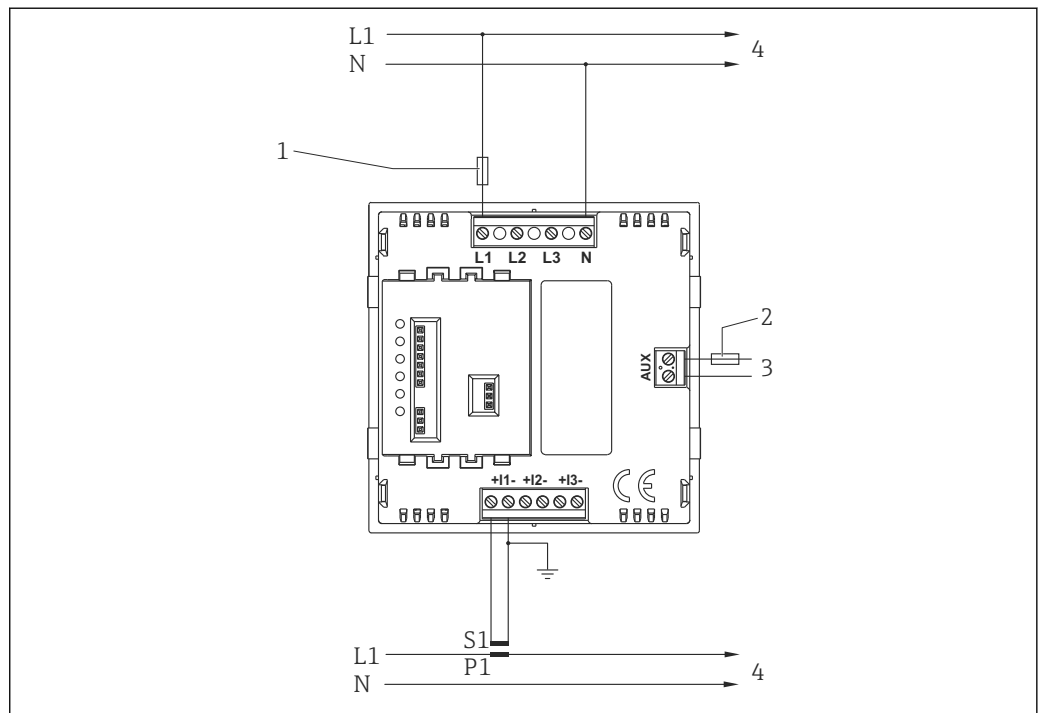

A0016400

7 Connection in single-phase, 2-wire power network

- 1 Fast-acting fuse 1 A
- 2 Slow-blow fuse 1 A
- 3 Supply voltage
- 4 Load

4.2.2 Connection in 3-phase, 3-wire power network

⚠ WARNING

The neutral wire connection (terminal N) is indirectly connected with the voltage input terminals (terminals L1, L2, L3). If connected to a 3-wire system, the neutral wire adopts a potential between the other wires.

Danger! Electric voltage!

- If the external wiring is connected to terminal N, it must be connected either to the neutral wire or protective ground to prevent the risk of electric shock from the neutral terminal.

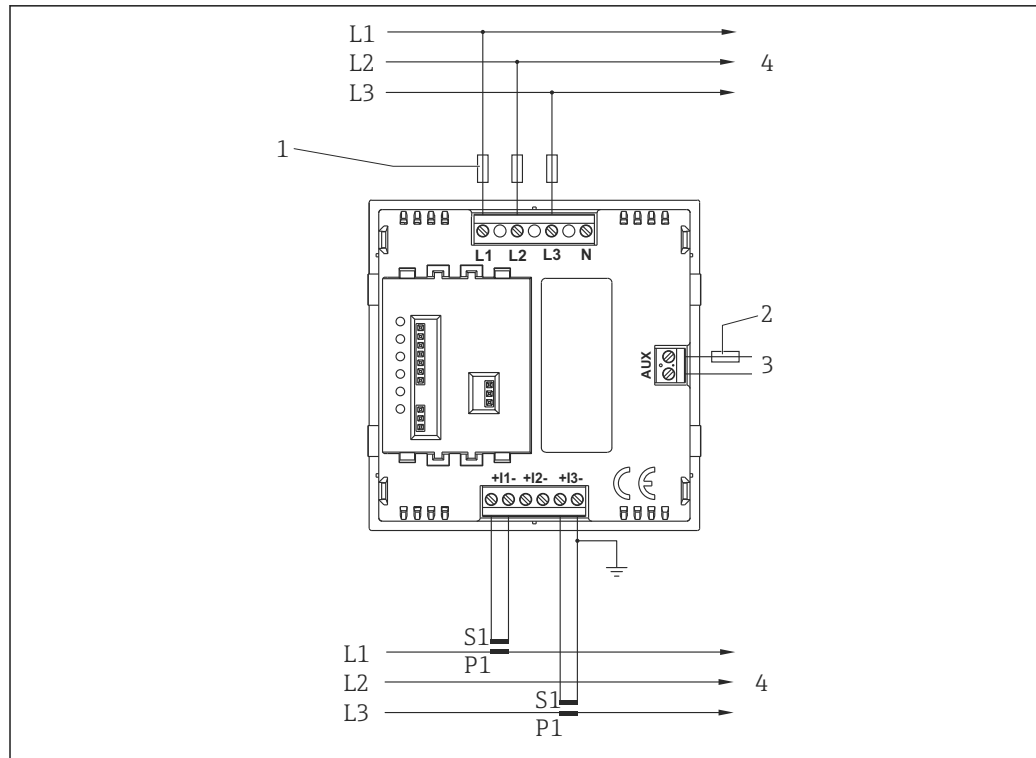

A0016404

8 Connection in 3-phase, 3-wire power network

- 1 Fast-acting fuse 1 A
- 2 Slow-blow fuse 1 A
- 3 Supply voltage
- 4 Load

The "S2" secondary terminals of the current transformers are connected in the multifunction electrical energy meter. Only one protective ground connection \oplus must be provided for this reason.

4.2.3 Connection in 3-phase, 4-wire power network

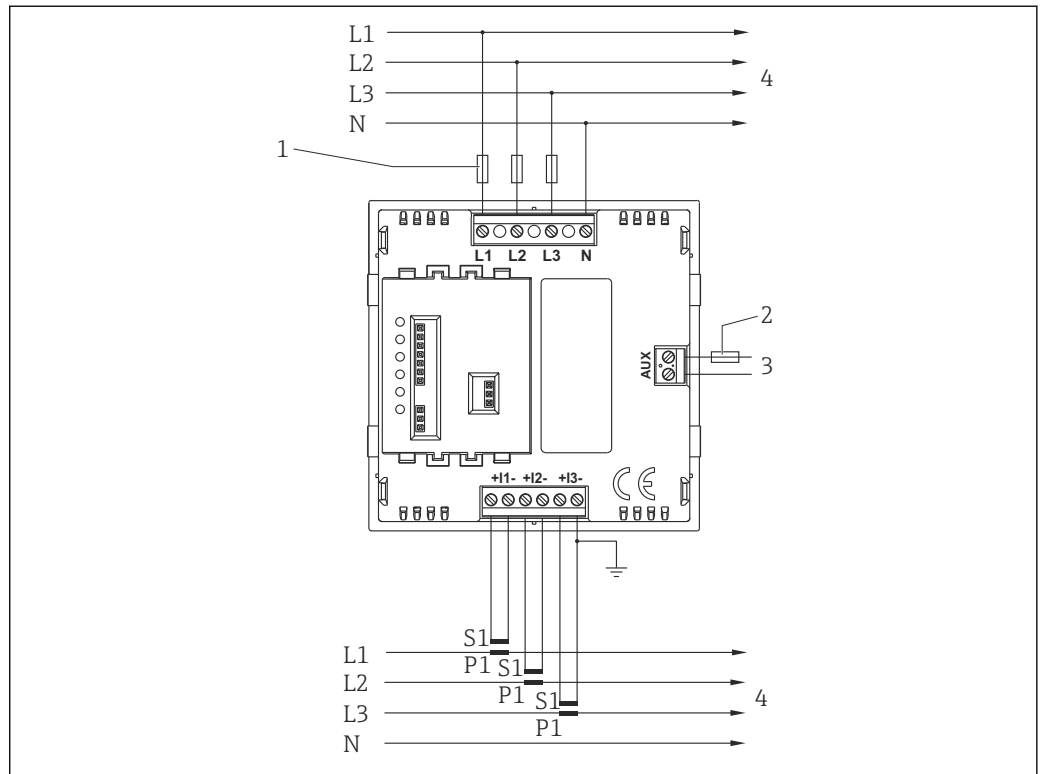

A0016406

9 Connection in 3-phase, 4-wire power network

- 1 Fast-acting fuse 1 A
- 2 Slow-blow fuse 1 A
- 3 Supply voltage
- 4 Load

The "S2" secondary terminals of the current transformers are connected in the multifunction electrical energy meter. Only one protective ground connection ⊕ must be provided for this reason.

4.3 Connecting the outputs

4.3.1 RS485 interface for communication via Modbus RTU or Metasys N2

The RS485 Modbus RTU interface is connected to the terminals of the RS485 / pulse module which are provided for this purpose.

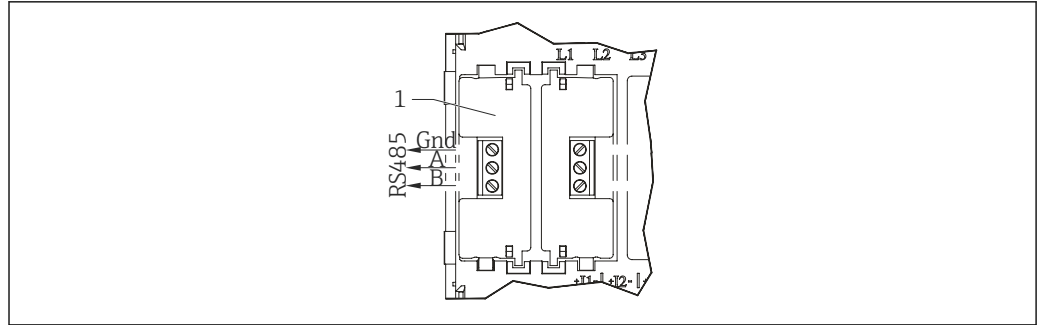

A0016407

10 Connecting the RS485 Modbus RTU interface

- 1 RS485 / pulse module

A shielded, two-wire cable is recommended for the connection between the RS485 master and the measuring device. A cable that is specially designed for connecting RS485 interfaces should be used where possible. However, satisfactory results can be achieved with most shielded cables for connection distances of just a few meters. Cat IV network cables also deliver satisfactory results. Given that the measuring device communicates with an external device via an RS485 connection, distances of up to 1200 m can be covered under good conditions. Electrical interference or other negative conditions can reduce the distance over which reliable operation is possible.

4.3.2 Pulse output

The pulse output/outputs is/are connected to the terminals of the pulse or RS485/pulse extension modules which are provided for this purpose.

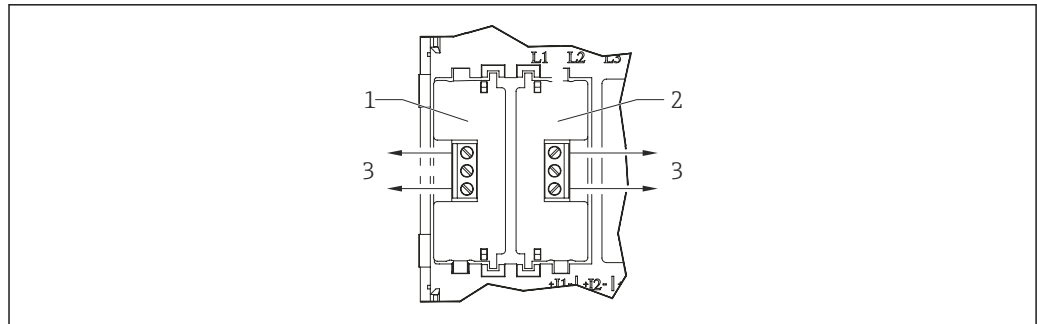

A0016408

11 Connecting the pulse output

- 1 RS485 / pulse module
- 2 Pulse module
- 3 Relay connection

Semi-conductor relays are provided. The nominal power is 250 V, 50 mA for each relay. Connecting cables must be as short as possible, meet the specific requirements and be filtered where necessary.

4.4 Post-connection check



Device condition and specifications	Notes
Are cables or the device damaged?	Visual inspection
Electrical connection	Notes
Does the supply voltage match the specifications in the "supply voltage" section?	(→ 12)

Are the mounted cables strain-relieved?	-
Are the power supply and signal cables correctly connected?	(→ 12) and (→ 15)

5 Operation





5.1 Display

The display screen is used in 2 operating modes:

- Display mode (→  18) to display measured values
- Configuration mode (→  18) of the multifunction electrical energy meter. The possible settings are described in the "Commissioning" section (→  21).

5.2 Operating elements

You can directly access various measured values via the 4 keys on the front of the multifunction electrical energy meter. The keys are used to configure the device in the configuration mode.



 A0016376	Is used to display voltage and frequency. This is the "Back" function in the configuration mode.
 A0016377	Is used to display the currents. This is the "Up" function in the configuration mode.
 A0016379	Is used to display the power values and the power factor. This is the "Down" function in the configuration mode.
 A0016378	Is used to display the energy values. This is the "Enter" function in the configuration mode.

5.3 Display mode

The measured values are shown on the backlit liquid crystal display.

Order in which measured values are displayed in the display mode



Key	View No.	Description 3-phase, 4-wire	View No.	Description 3-phase, 3-wire	View No.	Single-phase, 2-wire
 A0016376	1	V L1-N (voltage L1/N) V L2-N (voltage L2/N) V L3-N (voltage L3/N)	1	V L1-L2 (voltage L1/L2) V L2-L3 (voltage L2/L3) V L3-L1 (voltage L3/L1)	1	V L1 (voltage L1)
	2	V L1-L2 (voltage L1/L2) V L2-L3 (voltage L2/L3) V L3-L1 (voltage L3/L1)				
	3	Frequency	2	Frequency	2	Frequency
	4	V L1-N %THD* (%THD voltage L1/N) V L2-N %THD* (%THD voltage L2/N) V L3-N %THD* (%THD voltage L3/N)				
	5	V L1-L2 %THD* (%THD voltage L1/L2) V L2-L3 %THD* (%THD voltage L2/L3) V L3-L1 %THD* (%THD voltage L3/L1)	3	V L1-L2 %THD* (%THD voltage L1/L2) V L2-L3 %THD* (%THD voltage L2/L3) V L3-L1 %THD* (%THD voltage L3/L1)	3	V L1 %THD*
*) %THD = % Total Harmonic Distortion						



Key	View No.	Description 3-phase, 4-wire	View No.	Description 3-phase, 3-wire	View No.	Single-phase, 2-wire
 A0016377	1	A L1 (current L1) A L2 (current L2) A L3 (current L3)	1	A L1 (current L1) A L2 (current L2) A L3 (current L3)	1	A L1 (current L1)
	2	A neutral current				
	3	A L1 MAX (Current L1, maximum value, time-integrated, maximum indicator function) A L2 MAX (Current L2, maximum value, time-integrated, maximum indicator function) A L3 MAX (Current L3, maximum value, time-integrated, maximum indicator function)	2	A L1 MAX (Current L1, maximum value, time-integrated, maximum indicator function) A L2 MAX (Current L2, maximum value, time-integrated, maximum indicator function) A L3 MAX (Current L3, maximum value, time-integrated, maximum indicator function)	2	A L1 MAX (Current L1, maximum value, time-integrated, maximum indicator function)
	4	A neutral current MAX (Maximum value, time-integrated, maximum indicator function)				
	5	I %THD* L1 (%THD current L1) I %THD* L2 (%THD current L2) I %THD* L3 (%THD current L3)	3	I %THD* L1 (%THD current L1) I %THD* L2 (%THD current L2) I %THD* L3 (%THD current L3)	3	I %THD* L1 (%THD current L1)
 A0016379	1	kW active power kvar reactive power kVA apparent power	1	kW active power kvar reactive power kVA apparent power	1	kW active power kvar reactive power kVA apparent power
	2	kW MAX (active power, maximum value, time-integrated, maximum indicator function)	2	kW MAX (active power, maximum value, time-integrated, maximum indicator function)	2	kW MAX (active power, maximum value, time-integrated, maximum indicator function)
	3	PF power factor (with symbol: coil = inductive, capacitor = capacitance)	3	PF power factor (with symbol: coil = inductive, capacitor = capacitance)	3	PF power factor (with symbol: coil = inductive, capacitor = capacitance)
 A0016378	1	kWh electrical energy (active component)	1	kWh electrical energy (active component)	1	kWh electrical energy (active component)
	2	kvarh electrical energy (reactive component)	2	kvarh electrical energy (reactive component)	2	kvarh electrical energy (reactive component)

*) %THD = % Total Harmonic Distortion

5.4 Configuration mode

The abbreviation for the parameter is displayed in the top display row in the configuration mode. The middle row displays the parameter value. The bottom row is used to confirm the set value of the parameter.

To enter the configuration mode, press and hold the  and  keys simultaneously for 5 seconds. The screen to enter the 4-digit password is displayed. No default password is set. A password can be used to prevent unauthorized access to the device settings. Once the correct password has been entered, the device is on the first level of the menu structure. If a password was not configured for the device beforehand, the setup is called up by pressing the  key four times.

The parameter to be configured is selected with the  and  keys. When the  key is pressed, the parameter is selected and the user enters the second level of the menu structure. Values can be changed at this level, such as the values of the system

configuration, for example. There is a third level in the menu structure for some parameters, such as the parameters for communication. This level is reached in the same way. Once the necessary settings have been made, press the key to return to the first level in the menu structure.

Generally speaking, the \uparrow and \downarrow keys change the value of the parameter; the \leftarrow key confirms the change / setting and skips to the next display screen (next parameter).

You can exit the configuration mode at any time by pressing the \leftarrow and \leftarrow keys simultaneously for 5 seconds. Any changes that have already been made are retained. You can also exit the configuration mode by repeatedly pressing the \leftarrow key. In both cases, the device switches back to the last measured values displayed.

The possible settings are described in the "Commissioning" section (\rightarrow  21).

5.4.1 Entering numbers

Users must frequently change digits in the configuration mode, usually in the middle row of numbers.

The \uparrow key is used to increase and the \downarrow key to decrease a value.

The current digit to be changed flashes on the screen. Pressing the \leftarrow key accepts the set value and switches to the next digit. In each particular row of numbers, the digits are set in succession from left to right.

Pressing the \leftarrow key takes you back to the previous digit.

Once the last digit has been accepted, "SET" is displayed in the bottom row of the display.

5.5 Power-up screen

After powering up the energy meter (switching on the supply voltage), a number of screens are displayed by way of a self-test.

1st screen: All the LCD segments are displayed. This is used as a self-test for the display.

2nd screen: The firmware version of the energy meter is displayed.

3rd screen: Displays the result of the self-test when powering up the energy meter.

The device then switches to the first measured value display and displays the voltage values.

6 Commissioning

6.1 Post-installation check and switching on the device

Perform all the final checks before commissioning the device.

- Checklist for "post-installation check" (→ 📄 11)
- Checklist for "post-connection check" (→ 📄 16)

When the operating voltage is applied, a number of screens are first displayed by way of a self-test (→ 📄 20).

If you are commissioning the device for the first time, program the setup as described in the following sections. If you are commissioning a device that is already configured, the device starts measuring immediately as defined in the settings and the values are shown on the display.

6.2 Menu structure

		First level	Second level	Third level
Main menu	Password entry	CHNG PASS Change password	NPWd (new password)	Change the value of the password. Range for selection: 0 to 9999
		SYS (system configuration)	Choose from: <ul style="list-style-type: none"> ▪ 1P2W (single-phase, 2-wire) ▪ 3P3W (3-phase, 3-wire) ▪ 3P4W (3-phase, 4-wire) 	
		CT (current transformer primary value)	Change the value. Range for selection: 1 to 9999 A	
		dIT (integration time of average values for maximum indicator function)	Choose from: <ul style="list-style-type: none"> ▪ 60 minutes ▪ 30 minutes ▪ 20 minutes ▪ 15 minutes ▪ 10 minutes ▪ 8 minutes ▪ 5 minutes ▪ OFF 	
		RSET (reset)	Choose from: <ul style="list-style-type: none"> ▪ dmd (maximum time-integrated average values - maximum indicator function) ▪ ALL ▪ hour (kWh & kvarh) 	
COMS (communication)			FMT (protocol)	Choose from: <ul style="list-style-type: none"> ▪ Modb (Modbus RTU) ▪ N2 (Johnson Controls Metasys N2)
			bAUd (baud rate)	Choose from: <ul style="list-style-type: none"> ▪ 2 400 ▪ 4 800 ▪ 9 600 ▪ 19 200 ▪ 38 400
			PARI (parity)	Choose from: <ul style="list-style-type: none"> ▪ None ▪ Odd ▪ Even

First level	Second level	Third level
	STOP (stop bits)	Choose from: <ul style="list-style-type: none"> ▪ 1 ▪ 2
	Addr (device address)	Choose value from between 1 to 247
RLY (relay)	OP1 (value assignment to pulse output relay 1) OP2 (value assignment to pulse output relay 2)	Choose from: <ul style="list-style-type: none"> ▪ NONE ▪ kWh ▪ kvarh
	RATE (pulse value) Specifies the pulse value of both pulse outputs.	Choose from: <ul style="list-style-type: none"> ▪ 0.1 ▪ 1 ▪ 10 ▪ 100 ▪ 1 000
	PULS (pulse length) Specifies the pulse length of both pulse outputs.	Choose from: <ul style="list-style-type: none"> ▪ 60 ms ▪ 100 ms ▪ 200 ms
NRGY (energy)	Choose from: <ul style="list-style-type: none"> ▪ KILO ▪ MEGA 	
TEST	Choose from: <ul style="list-style-type: none"> ▪ disp ON (tests the segments of the LC display) ▪ disp TOGL (display toggle. Tests the segments of the LC display alternately) ▪ PHAS SEQ (checks the phase sequence) 	
SOFT (software)	Displays the version number of the internal software (firmware)	

6.2.1 Configuration example for the current transformer primary value

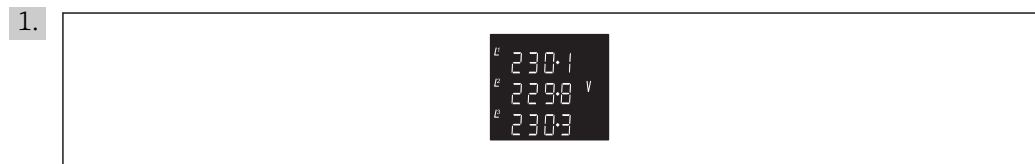



A0016388

Press the  and  keys simultaneously and hold for 5 seconds.



A0016389

The screen to enter the password is displayed.

2. To enter the default password "0000" which is set at the factory, press the  key four times or enter a password that has already been configured and press  to confirm.

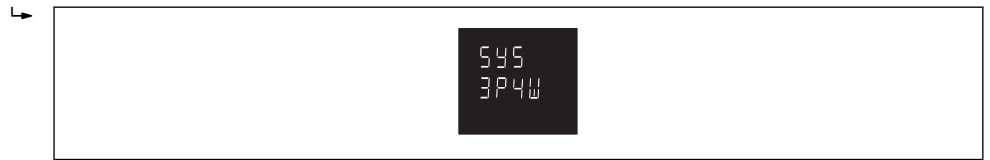

A0016390

The screen to make the settings for the system configuration is displayed.

3. Repeatedly press the key until the screen to set the current transformer primary value "CT" is displayed.



A0016391

4. Press the key.
 - ↳ The first digit starts flashing.
5. Use the and keys to set the desired value.
6. Press the key to confirm the set value.
 - ↳ The next digit starts flashing.
7. Repeat this procedure until the last digit has been set and confirmed.
 - ↳ The set value is displayed as follows, for example: 0100 = 100 A, 1000 = 1000 A, etc. "SET" now also appears on the display.

The current transformer primary value is now configured. Press the key to return to the first level in the menu structure. Other parameters can now be selected for configuration in the first level.

If no more settings need to be made, press the key again to switch to the display mode.

6.3 Device settings





Calling up the Setup menu

1. Press the and keys simultaneously for 5 seconds.
 - ↳ The screen to enter the password is displayed.
2. To enter the default password "0000" which is set at the factory, press the key four times or enter a password that has already been configured and press to confirm.
 - ↳ The screen to make the settings for the system configuration is displayed.

6.3.1 Changing the password - CHNG PASS

1. Call up the Setup menu.
2. Press the key.
 - ↳ CHNG PASS is displayed.
3. Press the key.
 - ↳ The first digit starts flashing.
4. Use the and keys to select the value of the first digit.
5. Press the key to confirm.
 - ↳ The next digit starts flashing.
6. Repeat this procedure until the last digit has been set and confirmed.
 - ↳ "SET" now also appears on the display.

6.3.2 System configuration - SYS







1. Call up the Setup menu.
 2. Press the  key.
 3. Use the  and  keys to choose from the following configuration options: 1P2W (single-phase, 2-wire = alternating current system), 3P3W (3-phase, 3-wire = three-phase system without a neutral wire), 3P4W (3-phase, 4-wire = three-phase system with a neutral wire)
 4. Press the  key to confirm your selection.
- "SET" is displayed.

6.3.3 Current transformer primary value (CT)

The transformer primary current must be configured in the range from 1/5 A to 9999/5 A to ensure current, power and energy values are displayed and recorded correctly. The setup sequence is explained in the (→  22) configuration example. Factory setting "0005".







6.3.4 Setting the demand integration time (maximum indicator function) - dIT

This function specifies the integration time for determining the maximum value for the current and power (details,). The values are displayed with "minutes" as the unit. Factory setting "60".

1. Call up the Setup menu.
 2. Press the  or  keys until dIT is displayed.
 3. Press the  key.
 4. Use the  and  keys to choose from the following configuration options: 60, 30, 20, 15, 10, 8, 5, OFF (= no integration time, the maximum value displayed refers to the peak value measured directly)
 5. Press the  key to confirm your selection.
- "SET" is displayed.



6.3.5 Reset – RSET

This function resets saved values.

1. Call up the Setup menu.
 2. Press the  or  keys until RSET is displayed.
 3. Press the  key. Initial display: "dmd"
 4. Use the  and  keys to choose from the following functions: dmd (reset the maximum values), ALL (reset kWh, kvarh and maximum values), hour (reset kWh and kvarh)
 5. Press the  key to reset the value.
- "RSET" is displayed.

6.3.6 Communication settings – COMS

This function is used to make the settings for the RS485 interface which enables the device to communicate via the Modbus or the Metasys N2 protocol.

1. Call up the Setup menu.
2. Press the  or  keys until COMS is displayed.
3. Press the  key.

4. Press the **A** or **P/PP** keys until the desired parameter is displayed.
5. Use the **E** key to start configuring the parameter.
6. Proceed as described in the following sections.

Protocol - PROT

The multifunction electrical energy meter is designed for communication via the RS485 interface via Modbus RTU or alternatively via Metasys N2.

1. Use the **A** and **P/PP** keys to choose from the following values: Modb (Modbus protocol), N2 (Metasys N2 protocol)
2. Press the **E** key to confirm your selection.
 - ↳ If "N2" is selected, it is only possible to configure the device address (→ 25). The other communication parameters cannot be modified.

"SET" is displayed.

Setting the baud rate - bAUd

The baud rate needed for Modbus RTU communication via the RS485 interface is selected in this function. Factory setting: "9600"

1. Use the **A** and **P/PP** keys to choose from the following values: 2400, 4800, 9600, 19200, 38400.
2. Press the **E** key to confirm your selection.

"SET" is displayed.

Setting the parity - PARI

This function sets the parity of the RS485 interface. Factory setting: "NONE"

1. Use the **A** and **P/PP** keys to choose from the following values: None, Odd, Even.
2. Press the **E** key to confirm your selection.

"SET" is displayed.

Stop bits - STOP

This function sets the number of stop bits for communication via the RS485 interface. As a prerequisite, the parity must be set to "NONE". Factory setting: "1"

1. Use the **A** and **P/PP** keys to choose from the following values: 1 = 1 stop bit, 2 = 2 stop bits.
2. Press the **E** key to confirm your selection.

"SET" is displayed.

Setting the device address - Addr

The device address must be configured for the multifunction electrical energy meter to communicate in a Modbus RTU or a Metasys N2 network. Factory setting: "1", display: "001"

The possible setting for Modbus is between 1 and 247, and between 1 and 255 for Metasys N2.

1. The first digit starts flashing once the parameter has been called up. Use the **A** and **P/PP** keys to set the desired value.
2. Press the **E** key to confirm.
 - ↳ The next digit starts flashing.
3. Set all 3 digits as required.
4. Press the **E** key to confirm.

"SET" is displayed.







Setting the floating point - Ordr

This function displays the direction of the floating point. Changes to the setting cannot be made from the energy meter. This setting can only be changed if an RS485 interface is available and the device is integrated into a Modbus RTU network.

6.3.7 Setting the relay outputs - RLY









This function defines the settings for the optional output relays (pulse outputs for energy). These settings are also possible if an output relay is not available.

Relay output 1 - OP1

1. Call up the Setup menu.
2. Press the  or  keys until RLY is displayed.
3. Press the  key. Initial display: "OP1", "kWh"
4. Press the  key again to assign the desired function to pulse output 1.
5. Use the  and  keys to choose from the following values: kWh (= use as pulse output for kWh), kvarh (= use as pulse output for kvarh), NONE (= not used)
6. Press the  key to confirm your selection.

"SET" is displayed. The device goes to the next parameter "OP2".





Relay output 2 - OP2

1. Call up the Setup menu.
2. Press the  or  keys until RLY is displayed.
3. Press the  key. Initial display: "OP1", "kWh"
4. Press the  key to switch to OP2. Initial display: "OP2", "kWh"
5. Press the  key again to assign the desired function to pulse output 2.
6. Use the  and  keys to choose from the following values: kWh (= use as pulse output for kWh), kvarh (= use as pulse output for kvarh), NONE (= not used)
7. Press the  key to confirm your selection.

"SET" is displayed. The device goes to the next parameter "RATE".

Pulse rate - RATE

This functions defines the pulse rate of **both** pulse outputs. Factory setting: "1"

1. Press the  key.
2. Use the  and  keys to choose from the following values: 0.1 (= 1 pulse corresponds to 0.1 kWh / kvarh), 1 (= 1 pulse corresponds to 1 kWh / kvarh), 10 (= 1 pulse corresponds to 10 kWh / varh), 100 (= 1 pulse corresponds to 100 kWh / kvarh), 1000 (= 1 pulse corresponds to 1 000 kWh / kvarh).
3. Press the  key to confirm your selection.

"SET" is displayed. The device goes to the next parameter "PULS".

Pulse length - PULS

This function defines the length of a pulse. Values displayed are in the unit "ms". Factory setting: "200"

1. Press the  key.

2. Use the **A** and **P/PP** keys to choose from the following values: 60, 100, 200
3. Press the **E** key to confirm your setting.

"SET" is displayed. The device returns to the first menu level.

6.3.8 Setting the display of energy values – NRGY

This function specifies whether the energy values are displayed with the "k" or "M" sign (kWh & kvarh or MWh & Mvarh).

1. Call up the Setup menu.
2. Press the **A** or **P/PP** keys until NRGY is displayed.
3. Press the **E** key.
4. Use the **A** and **P/PP** keys to choose from the following values: KILO (for kWh / kvarh), MEGA (for MWh / Mvarh).
5. Press the **E** key to confirm your selection.

"SET" is displayed. The device returns to the first menu level.

6.3.9 Self-test – TEST

This screen contains several functions for performing self-tests on the multifunction electrical energy meter.

1. Call up the Setup menu.
2. Press the **A** or **P/PP** keys until TEST is displayed.
3. Press the **E** key.
4. Use the **A** and **P/PP** keys to choose from the following values: diSP ON (when selected by pressing the **E** key, all the segments of the LCD display are switched on to allow users to detect a segment failure); diSP TOGL (when selected by pressing the **E** key, the display alternates between two different display modes. This helps the user identify whether individual segments do not switch off); PHAS SEQ (when selected by pressing the **E** key, this function checks whether the voltage and current connections have been established correctly on the energy meter. PSEQ (phase sequence), V 123, I 123 is displayed if all the connections are correct. If PSEQ, V 132, I 123, for example, is displayed, this indicates that a voltage connection is faulty. If PSEQ, V 12_, I 123, for example, is displayed, this indicates that a voltage connection is missing).

6.3.10 Displaying the software version – SOFT

This function directly displays the version of the internal software (firmware).

1. Call up the Setup menu.
2. Press the **A** or **P/PP** keys until SOFT is displayed.
3. Press the **E** key.

7 Maintenance

WARNING

The device is energized.

Danger! Risk of electric shock!

- ▶ Before performing any cleaning work on the device, the device must be de-energized. Live transformer cables must never be opened to remove any dust or dirt that may have accumulated.

In normal use, the measuring device does not require any maintenance.

The front of the measuring device should be wiped with a dry cloth only. Use minimum pressure and never apply pressure to the tinted viewing window. If necessary, the rear can also be wiped with a dry cloth. Only isopropyl alcohol can be used as a cleaning agent and should be used sparingly. Never use water. If the rear of the device or the terminals should be accidentally contaminated with water, the measuring device must be dried carefully before further service. If it is suspected that water or another contaminant might have entered the device, the device must be examined and overhauled at the factory.

All terminals must be examined regularly for corrosion and to ensure that the terminal connections have not become loose. This is particularly important if the device is exposed to vibrations.

8 Troubleshooting

8.1 Spare parts

No spare parts are available for the EngyVolt devices since the devices do not contain any components that can be replaced or configured by the user.

8.2 Return

Observe the following points when returning the device:

- Contact your Endress+Hauser Sales Center to obtain information about the procedure and basic conditions.
- Enclose a description of the error if sending in a device for repair.

8.3 Disposal

The device contains electronic components and must therefore be disposed of as electronic waste. Please pay particular attention to the national disposal regulations in your country.

9 Accessories

Description	Order number
Pulse output module	RK03-A1
RS485 Modbus RTU / pulse output module	RK03-A2

10 Technical data

10.1 Input

Measured variable	Measured process variables
	Current (L1, L2, L3,), voltage (L1/N, L2/N, L3/N or L1/L2, L2/L3, L3/L1 respectively), frequency in low-voltage systems
	Calculated process variables
	EngyVolt RV12: active, reactive and apparent power, power factor (Cos-Phi), imported and exported active and reactive energy, total harmonic distortion (current L1, L2, L3; voltage L1/N, L2/N, L3/N or L1/L2, L2/L3, L3/L1 respectively), neutral current, max. current (L1, L2, L3, N) ¹⁾ , max. active power ¹⁾ .
	EngyVolt RV15: active, reactive and apparent power, total harmonic distortion (current L1, L2, L3; voltage L1/N, L2/N, L3/N or L1/L2, L2/L3, L3/L1 respectively), active and reactive energy, neutral current, max. current (L1, L2, L3, N) ¹⁾ , max. active power ¹⁾ .

Measuring range	Nominal voltage	100 to 289 V AC L-N (173 to 500 V AC L-L)
	Voltage measuring range	25 to 600 V
	Maximum short-duration overvoltage	2 x nominal voltage for 1-second application repeated 5 times in 5-minute intervals
	Nominal current (secondary)	5 A AC RMS
	Secondary current measuring range	0.05 to 6 A
	Maximum short-duration overcurrent	10 x nominal current for 1-second application repeated 5 times in 5-minute intervals
	Primary current measuring range	1 to 9 999 A (per phase)
	Frequency	45 to 66 Hz
	Nominal power (secondary)	1 445 W (3-phase 4 325 W)
	Power measuring range (secondary)	14.45 to 2 080 W (3-phase: 43.25 to 6 228 W) ¹⁾
	Power measuring range (primary)	5 to 12 450 000 W (12.45 MW) ¹⁾
	Power consumption voltage circuits	<0.2 VA per phase
	Power consumption current circuits	<0.6 VA per phase

1) depending on CT

Energy counter	0 to 9 999 999.9 Wh, kWh, MWh / varh, kvarh, Mvarh
----------------	--

1) calculated from the integrated averages and representation as maximum value over an adjustable interval of 5, 8, 10, 15, 20, 30, 60 min

10.2 Output

Output signal

Pulse output

Number	EngyVolt RV12: 1 EngyVolt RV15: max. 2 (optional, via extension modules)
Contact load	50 mA maximum at 250 V AC
Version	Semiconductor relay

RS485 MODBUS

Number	EngyVolt RV12: 1 EngyVolt RV15: 1 (optional, via extension module)
Type	Two-wire, half-duplex
Baud rate	2400, 4800, 9600, 19200, 38400

10.3 Power supply

Supply voltage

AC nominal voltage	110 to 400 V AC $\pm 10\%$
DC nominal voltage	120 to 350 V DC $\pm 20\%$

Power consumption

5 VA

Electrical connection

 **The measuring device is designed exclusively for operation on external current converters.**

The multifunction EngyVolt RV12 and RV15 electrical energy meters are suitable for single-phase and three-phase power systems with 3 or 4 wires.

The "S2" secondary terminals of the current converters are connected in the electrical energy meter. Only one protective ground connection \ominus is provided for this reason.

Terminals

Screw-clamp terminals 0.05 to 2.5 mm² (30 to 14 AWG)

10.4 Performance characteristics

Reference operating conditions

Reference temperature	23 °C ± 1 °C (73.4 °F ± 1.8 °F)
Input wave form	50 or 60 Hz $\pm 2\%$
	Sinusoidal (distortion factor < 0.005)
Supply voltage	Nominal voltage $\pm 1\%$
Supply voltage frequency (with AC)	Nominal frequency $\pm 1\%$
Supply voltage wave form	Sinusoidal (distortion factor < 0.05)

Maximum measured error Extended measured error: IEC 688: 1992

Current (A)	0.5 % of nominal current
Voltage (V)	0.5 % of max. nominal voltage (4 % for I2 in 3-phase 3-wire operation)
Calculated neutral current (A)	4 % of nominal current
Frequency (Hz)	0.1 Hz
Power factor (PF = Cos-Phi)	0 to 1 Power factor is only indicated when the measured VA is over 3 % of range maximum
Active power (W)	±1 % of nominal power
Reactive power (var)	±1 % of nominal power
Apparent power (VA)	±1 % of nominal power
Active energy (kWh)	Class 1 (IEC 62053-21)
Reactive energy (kvarh)	±1 % of measuring range
THD	1 % up to 31st harmonic

Display repetition rate

1 s typically up to >99 % of the full scale value

Measurement and calculation interval

Max. 300 ms (maximum with %THD measurement)

Influence of ambient temperature Current and voltage: 0.013 %/°C (0.0072 %/°F) of nominal value
Power: 0.018 %/°C (0.01 %/°F) of measuring range

Error change due to variation of an influence quantity in the manner described in Section 6 of IEC 688:1992 2 x error allowed for the reference condition applied in the test. Error due to temperature variation as above.

Error in measurement when a measurand is within its measuring range, but outside its reference range 2 x error allowed at the end of the reference range adjacent to the section of the measuring range, where the measurand is currently operating / being tested.

Warm-up period 1 minute

10.5 Installation

Mounting location **EngyVolt RV15**
Housing for panel installation as per DIN 96, max. panel thickness 5 mm (0.2 in)
The device is secured using the snap-on fastening unit which is integrated in the housing. When mounting, make sure there is sufficient room to connect cables and wires on all sides of the measuring device.

Orientation Vertical

10.6 Environment

Ambient temperature range -10 to 55 °C (14 to 131 °F)

Storage temperature -20 to 70 °C (-4 to 158 °F)

Humidity 0 to 90 %, non-condensing

Altitude Up to 2 000 m (6 560 ft)

Degree of protection	EngyVolt RV12	EngyVolt RV15
	IP30 minimum	Degree of protection at front IP52
		Degree of protection at rear IP30

Shock resistance 30 g in 3 planes

Vibration resistance 10 to 50 Hz, IEC 60068-2-6, 2 g

Electromagnetic compatibility EMC emissions: BS EN 61326, Class A
Interference immunity: BS EN 61326, Class A

Dielectric strength 3.25 kV for 1 minute between communication outputs and measuring inputs, communication outputs and supply voltage. Supply voltage and measuring inputs

10.7 Mechanical construction

Dimensions

EngyVolt RV15 (panel-mounted)

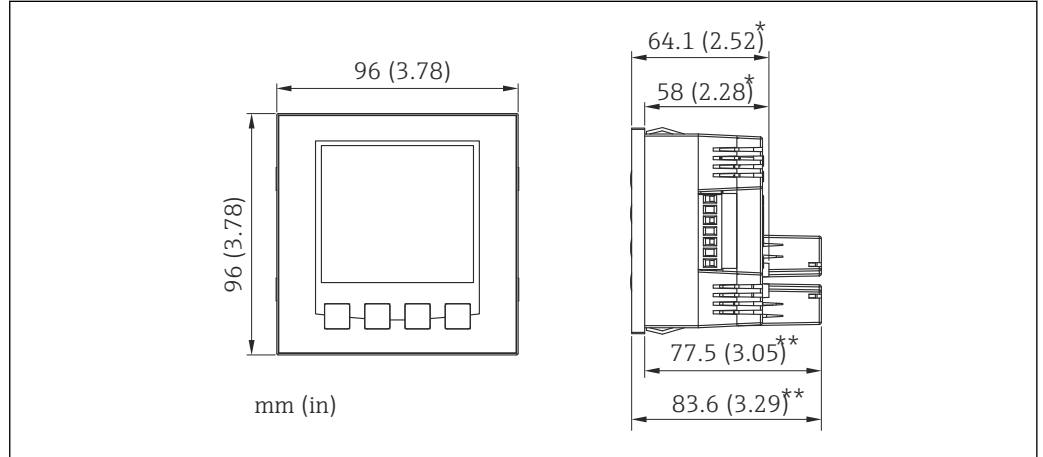

A0016361

12 Device dimensions

* Basic device

** Basic device with extension module

Panel thickness

1 to 5 mm (0.04 to 0.2 in.)

Weight

300 g (0.66 lb)

Materials

Polycarbonate as per UL94V0

10.8 Operability

Local operation

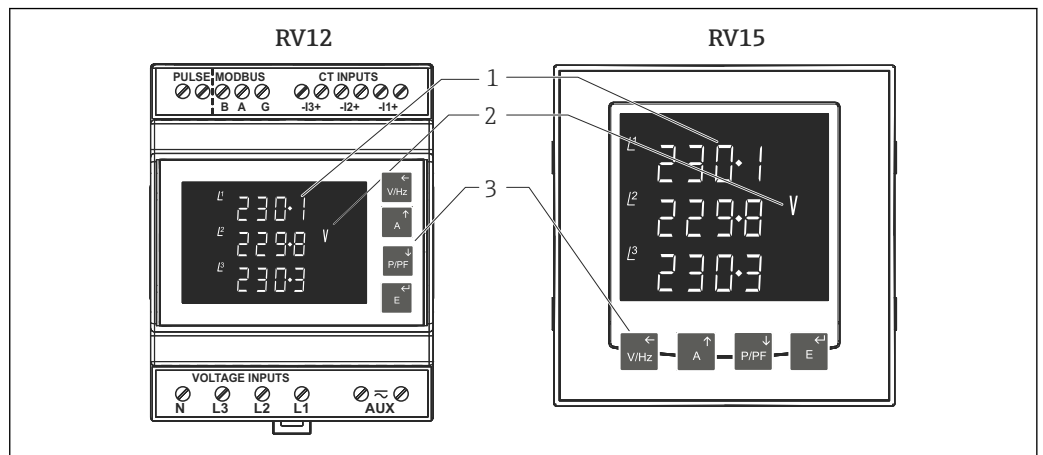

A0016505

13 Display and operating elements of the EngyVolt devices

1 Three-line display

2 Symbol for parameter displayed

3 Operating keys

The display screen is used in 2 operating modes:

- Display mode to indicate measured values
- Configuration mode of the multifunction electrical energy meter

Display mode

The measured values are shown on the backlit liquid crystal display. The user can call up and run through 15 different views using the operating elements on the front panel.

Configuration mode

The abbreviation for the parameter is displayed in the top display row in the configuration mode. The middle row displays the parameter value. The bottom row is used to confirm the set value of the parameter. Generally speaking, the "A" and "P/PF" keys change the value of the parameter; the "E" key confirms the change / setting and skips to the next display screen (next parameter).

10.9 Certificates and approvals

CE mark

Declaration of Conformity

The product meets the requirements of the harmonized European standards.

As such, it complies with the legal specifications of the EC directives.

The manufacturer confirms successful testing of the product by affixing to it the CE mark.

Other standards and guidelines

- IEC 60529:
Degrees of protection provided by enclosures (IP code)
- IEC 61010-1: 2001
Safety requirements for electrical equipment for measurement, control and laboratory use

11 Appendix

11.1 Basis of measurement and calculations

11.1.1 Phase to Phase voltages for 3 phase 4 wire devices

Phase to Phase voltages are measured directly and calculated as RMS values. Situations where the phases are not spaced 120 degrees apart (e.g. 4 wire open delta) are indicated correctly.

11.1.2 Reactive and Apparent Power

Active powers are calculated directly by multiplication of voltage and current samples. Reactive powers are calculated using the frequency corrected quarter phase time delay method. Apparent power is calculated as the square root of the sum of the squares of active and reactive powers.

11.1.3 Energy resolution

Cumulative energy counts are reported using the standard IEEE floating point format. Reported energy values in excess of 1 000 000 one million may show a small non cumulative error in the integer digits due to the limitations of the number format. Internally the count is maintained with greater precision. The reporting error is less than 1 part per 1 000 000 and is automatically corrected when the count increases.

11.1.4 Power factor

The magnitude of Per Phase Power Factor is derived from the per phase active power and per phase reactive power. The power factor value sign is set to negative for an inductive load and positive for a capacitive load. The magnitude of the System Power Factor is derived from the sum of the per phase active power and per phase reactive power. Individual phases whose apparent power is less than 2 % of nominal are not included in power factor determinations. The system power factor value sign is set to negative for an inductive load and positive for a capacitive load. The load type, capacitive or inductive, is determined from the signs of the sums of the relevant active powers and reactive powers. If both signs are the same, then the load is inductive, if the signs are different then the load is capacitive. The magnitude of the phase angle is the ArcCos of the power factor. Its sign is taken as the opposite of the VAR's sign.

11.1.5 Maximum demand (drag indicator)

The maximum power consumption of an installation is provided as power utilities often levy related charges. Many utilities use a thermal maximum demand indicator (MDI) to measure this peak power consumption. An MDI averages the power consumed over a number of minutes, reflecting the thermal load that the demand places on the supply system. The Integra Ci3 digital meter uses a sliding window algorithm to simulate the characteristics of a thermal MDI instrument, with the demand period being updated every minute.

Demand Integration Times can be set to various values. Maximum Demand is the maximum power or current demand that has occurred since the unit was last reset. This is maintained as a continuous record of the highest demand value that has been reached. Note: During the initial period when the "sliding window" does not yet contain a full set of readings (e.g. during initial commissioning). Then maximum demands may not be true due to the absence of immediate historical data.

11.1.6 Total harmonic distortion – THD

The calculation used for Total Harmonic Distortion is: $THD = ((RMS \text{ of total waveform} - RMS \text{ of fundamental}) / RMS \text{ of total waveform}) \times 100$. This is often referred to as THD-R, and lies in the range 0 to 100 %. THD measurement is subject to the 'range of use' limits. The device may give erratic or incorrect readings where the THD is very high and the fundamental is essentially absent. For low signal levels the noise contributions from the signal may represent a significant portion of the "RMS of total waveform" and may thus generate unexpectedly high values of THD. In this case the product will produce a display of 0 (zero). Typically, display of THD will only produce the 0 (zero) value when the THD calculation has been suppressed due to a low signal level being detected. It should also be noted that spurious signals (for example, switching spikes) may be included in the "RMS of the total waveform" and will be used in the calculation of THD. The display of THD may be seen to fluctuate under these conditions.

11.1.7 Testing the phase sequence

The voltage and current inputs must be greater than 5 % of nominal for the test to operate reliably.

In the 3 phase 4 wire operating mode the measured values are referenced from L1.

For the voltage sequence test, the phase of L2 relative to L1 must be within the window 240 ± 48 degrees and L3 relative to L1 must be within the window 120 ± 48 degrees to record the sequence V123.

Alternatively, the phase of L2 relative to L1 must be within the window 120 ± 48 degrees and L3 relative to L1 must be within the window 240 ± 48 degrees to record the sequence V132.

For the current sequence test, the phase of I1 relative to L1 must be within the window 0 ± 48 degrees, I2 relative to L1 must be within the window 240 ± 48 degrees, and I3 relative to L1 must be within the window 120 ± 120 degrees to record the sequence i123.

Alternatively the phase of I1 relative to L1 must be within the window 0 ± 48 degrees, I2 relative to L1 must be within the window 120 ± 48 degrees, and I3 relative to L1 must be within the window 240 ± 48 degrees to record the sequence i132.

In the 3 phase 3 wire operating mode measurements are referenced from L1-L2.

For the voltage sequence test, the phase of L2-L3 relative to L1-L2 must be within the window 240 ± 48 degrees L3-L1 relative to L1-L2 must be within the window 120 ± 48 degrees to record the sequence V123.

Alternatively, the phase of L2-L3 relative to L1-L2 must be within the window 120 ± 48 and L3 relative to L1-L2 must be within the window 240 ± 48 degrees to record the sequence V132.

For the current sequence test, the phase of I1 relative to L1-L2 must be within the window 330 ± 48 degrees, I2 relative to L1-L2 must be within the window 210 ± 48 degrees, and I3 relative to L1-L2 must be within the window 90 ± 48 degrees to record the sequence i123.

Alternatively, the phase of I1 relative to L1-L2 must be within the window 330 ± 48 degrees, I2 relative to L1-L2 must be within the window 90 ± 48 degrees, and I3 relative to L1-L2 must be within the window 210 ± 48 degrees to record the sequence i132.

11.2 Modbus implementation

11.2.1 Modbus protocol overview

In order to use the EngyVolt RV15 in a Modbus network, the optional RS485 / Pulse module is required

This section provides basic information for interfacing a multifunctional electrical energy meter to a Modbus protocol network. If background information or more details of the EngyVolt implementation is required please refer to the following sections of this document. EngyVolt devices offer the option of an RS485 communication facility for direct connection to SCADA or other communications systems using the Modbus Protocol RTU slave protocol. The Modbus Protocol establishes the format for the master's query by placing into it the device address, a function code defining the requested action, any data to be sent, and an error checking field. The slave's response message is also constructed using Modbus Protocol. It contains fields confirming the action taken, any data to be returned, and an error-checking field. If an error occurs in receipt of the message, the device will make no response. If the device is unable to perform the requested action, it will construct an error message and send it as the response.

The electrical interface is 2-wire RS485, via 3 screw terminals. Connection should be made using twisted pair screened cable and the following electrical data:

Nominal inductivity	0.2 μ H/ft
Nominal capacity line-line	24 pF/ft
Maximum operating voltage	300 V RMS

All "A" and "B" connections are daisy chained together. The screens should also be connected to the "Gnd" terminal. To avoid the possibility of loop currents, an Earth connection should be made at only one point on the network. Line topology may or may not require terminating loads depending on the type and length of cable used. Loop (ring) topology does not require any termination load. The impedance of the termination load should match the impedance of the cable and be at both ends of the line. The cable should be terminated at each end with a 120 Ω resistor. The load capacity of the resistor should be 0.25 W. A total maximum length of 1 200 m (3 900 ft) is allowed for the RS485 network. A maximum of 32 electrical nodes can be connected, including the controller. The address of each EngyVolt device can be set to any value between 1 and 247. Broadcast mode (address 0) is not supported. The maximum latency time of an EngyVolt device is 60 ms, i.e. this is the amount of time that can pass before the first response character is output. The supervisory program must allow this period of time to elapse before assuming that the device is not going to respond.

The format for each byte in RTU mode is:

Coding system	8-bit per byte
Data format	4 bytes (2 registers) per parameter. Floating point format (to IEEE 754) Most significant register first (Default). The default may be changed if required - See Holding Register "Register Order" .
Error check field	2 byte Cyclical Redundancy Check (CRC)
Framing	1 start bit 8 data bits, least significant bit sent first 1 bit for even/odd parity (or no parity) 1 stop bit if parity is used; 1 or 2 bits if no parity

Data coding

All data values in the EngyVolt device are transferred as 32 bit IEEE 754 floating point numbers, (input and output) therefore each device value is transferred using two Modbus protocol registers. All register read requests and data write requests must specify an even number of registers. Attempts to read/write an odd number of registers prompt the device to return a Modbus protocol exception message.

The multifunctional electrical energy meters can transfer a maximum of 40 values in a single transaction, therefore the maximum number of registers requestable is 80. Exceeding this limit prompts the device to generate an exception response.

Data transmission speed is selectable between 2400, 4800, 9600, 19200 and 38400 baud.

11.2.2 Input registers

Input registers are used to indicate the present values of the measured and calculated electrical quantities. Each parameter is held in two consecutive 16 bit registers. The following table details the 3X register address, and the values of the address bytes within the message. A tick (☑) in the column indicates that the parameter is valid for the particular wiring system. Any parameter with a cross (✗) will return the value Zero. Each parameter is held in the 3X registers. Modbus Protocol Function Code 04 is used to access all parameters.

For example, to request	Amps 1 (current Phase 1)	Start address	= 0006
		No of registers	= 0002
	Amps 2 (current Phase 2)	Start address	= 0008
		No of registers	= 0002

Each request for data must be restricted to 40 parameters or less. Exceeding the 40 parameter limit will cause a Modbus Protocol exception code to be returned.

Address (Register)	Parameter number	EngyVolt input register parameter description	Unit	Modbus-Startadresse Hex		3 Ø	3 Ø	1 Ø
				Hi Byte	Lo Byte	4 W	3 W	2 W
30001	1	Phase 1 line to neutral volts	Volt	00	00	☑	✗	☑
30003	2	Phase 2 line to neutral volts	Volt	00	02	☑	✗	✗
30005	3	Phase 3 line to neutral volts	Volt	00	04	☑	✗	✗
30007	4	Phase 1 current	Ampere	00	06	☑	☑	☑
30009	5	Phase 2 current	Ampere	00	08	☑	☑	✗
30011	6	Phase 3 current	Ampere	00	0A	☑	☑	✗
30013	7	Phase 1 power	Watt	00	0C	☑	✗	☑
30015	8	Phase 2 power	Watt	00	0E	☑	✗	✗
30017	9	Phase 3 power	Watt	00	10	☑	✗	✗
30019	10	Phase 1 volt amps	VA	00	12	☑	✗	☑
30021	11	Phase 2 volt amps	VA	00	14	☑	✗	✗
30023	12	Phase 3 volt amps	VA	00	16	☑	✗	✗
30025	13	Phase 1 volt amps reactive	Var	00	18	☑	✗	☑
30027	14	Phase 2 volt amps reactive	Var	00	1A	☑	✗	✗
30029	15	Phase 3 volt amps reactive	var	00	1C	☑	✗	✗
30031	16	Phase 1 power factor (*1).	-	00	1E	☑	✗	☑
30033	17	Phase 2 power factor (*1)	-	00	20	☑	✗	✗
30035	18	Phase 3 power factor (*1)	-	00	22	☑	✗	✗
30037	19	Phase 1 phase angle	Degrees	00	24	☑	✗	☑
30039	20	Phase 2 phase angle	Degrees	00	26	☑	✗	✗
30041	21	Phase 3 phase angle	Degrees	00	28	☑	✗	✗
30043	22	Average line to neutral volts	Volt	00	2A	☑	✗	✗
30047	24	Average line current	Ampere	00	2E	☑	☑	☑
30049	25	Sum of line currents	Ampere	00	30	☑	☑	☑

Address (Register)	Parameter number	EngyVolt input register parameter description	Modbus-Startadresse Hex			3 Ø	3 Ø	1 Ø
			Unit	Hi Byte	Lo Byte	4 W	3 W	2 W
30053	27	Total system power.	Watt	00	34	☑	☑	☑
30057	29	Total system volt amps	VA	00	38	☑	☑	☑
30061	31	Total system Var.	var	00	3C	☑	☑	☑
30063	32	Total system power factor (*1)	-	00	3E	☑	☑	☑
30067	34	Total system phase angle	Degrees	00	42	☑	☑	☑
30071	36	Frequency of supply voltages	Hz	00	46	☑	☑	☑
30073	37	Import Wh since last reset (*2)	kWh/MWh	00	48	☑	☑	☑
30075	38	Export Wh since last reset (*2)	kWh/MWh	00	4A	☑	☑	☑
30077	39	Import varh since last reset (*2)	kvarh/Mvarh	00	4C	☑	☑	☑
30079	40	Export varh since last reset (*2)	kvarh/Mvarh	00	4E	☑	☑	☑
30081	41	VAh since last reset (*2)	kVAh/MVAh	00	50	☑	☑	☑
30083	42	Ah since last reset (*3)	Ah/kAh	00	52	☑	☑	☑
30085	43	Total system power demand Δt (*4)	Watt	00	54	☑	☑	☑
30087	44	Maximum total system power demand Δt (*4)	Watt	00	56	☑	☑	☑
30101	51	Total system VA demand Δt	VA	00	64	☑	☑	☑
30103	52	Maximum total system VA demand Δt	VA	00	66	☑	☑	☑
30105	53	Neutral current demand Δt	Ampere	00	68	☑	✗	✗
30107	54	Maximum neutral current demand Δt	Ampere	00	6A	☑	✗	✗
30201	101	Line 1 to Line 2 volts	Volt	00	C8	☑	☑	✗
30203	102	Line 2 to Line 3 volts	Volt	00	CA	☑	☑	✗
30205	103	Line 3 to Line 1 volts	Volt	00	CC	☑	☑	✗
30207	104	Average line to line volts	Volt	00	CE	☑	☑	✗
30225	113	Neutral current	Ampere	00	E0	☑	✗	✗
30235	118	Phase 1 L/N volts THD	%	00	EA	☑	✗	☑
30237	119	Phase 2 L/N volts THD	%	00	EC	☑	✗	✗
30239	120	Phase 3 L/N volts THD	%	00	EE	☑	✗	✗
30241	121	Phase 1 Current THD	%	00	F0	☑	☑	☑
30243	122	Phase 2 Current THD	%	00	F2	☑	☑	✗
30245	123	Phase 3 Current THD	%	00	F4	☑	☑	✗
30249	125	Average line to neutral volts THD	%	00	F8	☑	✗	☑
30251	126	Average line current THD	%	00	FA	☑	☑	☑
30255	128	-Total system power factor (*5)	Degrees	00	FE	☑	☑	☑
30259	130	Phase 1 current demand Δt	Ampere	01	02	☑	☑	☑
30261	131	Phase 2 current demand Δt	Ampere	01	04	☑	☑	✗
30263	132	Phase 3 current demand Δt	Ampere	01	06	☑	☑	✗
30265	133	Maximum phase 1 current demand Δt	Ampere	01	08	☑	☑	☑
30267	134	Maximum phase 2 current demand Δt	Ampere	01	0A	☑	☑	✗
30269	135	Maximum phase 3 current demand Δt	Ampere	01	0C	☑	☑	✗
30335	168	Line 1 to line 2 volts THD	%	01	4E	☑	☑	✗
30337	169	Line 2 to line 3 volts THD	%	01	50	☑	☑	✗

Address (Register)	Parameter number	EngyVolt input register parameter description	Modbus-Startadresse Hex			3 Ø	3 Ø	1 Ø
			Unit	Hi Byte	Lo Byte	4 W	3 W	2 W
30339	170	Line 3 to line 1 volts THD	%	01	52	<input checked="" type="checkbox"/>	<input checked="" type="checkbox"/>	<input checked="" type="checkbox"/>
30341	171	Average line to line volts THD	%	01	54	<input checked="" type="checkbox"/>	<input checked="" type="checkbox"/>	<input checked="" type="checkbox"/>

*1)	The power factor has its sign adjusted to indicate the nature of the load. Positive for capacitive and negative for inductive.
2*)	There is a user option to select either k or M for the energy prefix.
3*)	The same user option as in 2 above gives a prefix of none or k for Amphours
4*)	The power sum demand calculation is for import power only.
5*)	The negative total system power factor is a sign inverted version of parameter 32, the magnitude is the same as parameter 32.
6*)	There is a user option to select None, k or M for the energy prefix.

11.2.3 Modbus protocol holding registers and EngyVolt set up

Holding registers are used to store and display instrument configuration settings. All holding registers not listed in the table below should be considered as reserved for manufacturer use and no attempt should be made to modify their values. The holding register parameters may be viewed or changed using the Modbus Protocol. Each parameter is held in two consecutive 4X registers. Modbus Protocol Function Code 03 is used to read the parameter and Function Code 16 is used to write. Write to only one parameter per message.

Address (Register)	Parameter number	Parameter Holding register	Modbus start address Hex		Valid range	Mode
			High Byte	Low Byte		
40001	1	Demand time (Δt)	00	00	Read minutes into first demand calculation. When the Demand Time reaches the Demand Period then the demand values are valid.	ro
40003	2	Demand period (Δt)	00	02	Write demand period: 0, 5, 8, 10, 15, 20, 30 or 60 minutes. Default: 60 minutes. Setting the period to 0 will cause the demand to show the current parameter value, and demand max to show the maximum parameter value since last demand reset.	r/w
40007	4	System Volts	00	06	Read system voltage, VLL for 3P3W, VLN for others.	ro
40009	5	System current	00	08	Write system current, limited to 1 to 9999 A. Requires password, see parameter 13	r/w
40011	6	System type	00	0A	Write system type 3p4w = 3 3p3w = 2 1p2w = 1 Requires password, see parameter 13	r/w
40013	7	Relay pulse width	00	0C	Write relay on period in milliseconds: 60, 100, 200 Default: 200	r/w

Address (Register)	Parameter number	Parameter Holding register	Modbus start address Hex		Valid range	Mode
			High Byte	Low Byte		
40015	8	Password lock	00	0E	Write any value to password lock protected registers. Read password lock status: 0 = locked 1 = unlocked Reading will also reset the password timeout back to one minute.	r/w
40019	10	Network parity stop	00	12	Write the network port parity/stop bits for Modbus Protocol, where 0 = One stop bit and no parity, default. 1 = One stop bit and even parity. 2 = One stop bit and odd parity. 3 = Two stop bits and no parity. Requires a restart to become effective.	r/w
40021	11	Network node	00	14	Write the network port node address: 1 to 247 for Modbus protocol. Default: 1 Valid range 1 to 247. Requires a restart to become effective. Note, both the Modbus protocol and Johnson Controls node addresses can be changed via the display setup menus.	r/w
40023	12	Pulse divisor	00	16	Write pulse divisor index: N = 2 to 6 in Wh/10 ^N . Default: 3	r/w
40025	13	Password	00	18	Write password for access to protected registers. Read zero. Default: 0000 Reading will also reset the password timeout back to one minute.	r/w
40029	15	Network baud rate	00	1C	Write the network port baud rate for Modbus protocol. Valid values: 0 = 2400 baud 1 = 4800 baud 2 = 9600 baud (default) 3 = 19200 baud 4 = 38400 baud Requires a restart to become effective.	r/w
40031	16	Energy units prefix	00	1E	Write the units prefix for energy output values. 0 = k (e.g. kWh, but Ah for ampere hours - default) 1 = M (e.g. MWh, but kWh for ampere hours)	r/w
40037	19	System power	00	24	Read the total system power, e.g. for 3p4w returns System Volts x System Amps x 3.	ro
40041	21	Register order	00	28	Write the value 2141 in the required register order.	r/w
40043	22	Serial number Hi	00	2A	Read the first product serial number.	ro

Address (Register)	Parameter number	Parameter Holding register	Modbus start address Hex		Valid range	Mode
			High Byte	Low Byte		
40045	23	Serial Number Lo	00	2C	Read the second product serial number.	ro
40087	44	Relay 1 energy type	00	56	Write MODBUS Protocol input parameter for pulse relay 1 0 = relay off 37 = import Wh 39 = import varh Default = 37	r/w
40089	45	Relay 2 energy type	00	58	Write MODBUS Protocol input parameter for pulse relay 1 0 = relay off 37 = import Wh 39 = import varh Default = 37	r/w
40217	109	Reset logged data	00	D8	Write code to reset data group. 1 = energy 2 = demand maximums 3 = demand maximums and demand time	r/w

Register order

Register order controls the order in which the device receives or sends floating-point numbers: - normal or reversed register order. In normal mode, the two registers that make up a floating point number are sent most significant register first. In reversed register mode, the two registers that make up a floating point number are sent least significant register first. To set the mode, write the value '2141.0' into this register - the instrument will detect the order used to send this value and set that order for all Modbus Protocol transactions involving floating point numbers.

It is perfectly feasible to change EngyVolt devices set-up using a general purpose Modbus Protocol master, but often easier to use the device display, especially for gaining password protected access.

Password

Some of the parameters described above are password protected and thus require the password to be entered at the Password register before they can be changed. The default password is 0000. When the password has been entered it will timeout in one minute unless the Password or Password Lock register is read to reset the timeout timer. Once the required changes have been made to the protected parameters the password lock should be reapplied by

- allowing the password to timeout, or
- writing any value to the Password Lock register, or
- power cycling the instrument.

11.3 RS485 general information

Some of the information in this section relates to other product families, and is included to assist where a mixed network is implemented.

RS485 or EIA (Electronic Industries Association) RS485 is a balanced line, half-duplex transmission system allowing transmission distances of up to 1 200 m (3 900 ft). The following table summarises the RS-485 Standard:

PARAMETER	Value
Mode of Operation	Differential
Number of Drivers and Receivers	32 Drivers, 32 Receivers
Maximum Cable Length	1 200 m (3 900 ft)
Maximum Data Rate	10 Mbaud
Maximum Common Mode Voltage	12 to -7 V
Minimum Driver Output Levels (Loaded)	± 1.5 V
Minimum Driver Output Levels (Unloaded)	± 6 V
Drive Load	Minimum 60 Ω
Driver Output Short Circuit Current Limit	150 mA to GND 250 mA to 12 V 250 mA to -7 V
Minimum Receiver Input Resistance	12 k Ω
Receiver Sensitivity	± 200 mV

Further information relating to RS485 may be obtained from either the EIA or the various RS485 device manufacturers.

11.3.1 Half duplex

Half duplex is a system in which one or more transmitters (talkers) can communicate with one or more receivers (listeners) with only one transmitter being active at any one time. For example, a “conversation” is started by asking a question, the person who has asked the question will then listen until he gets an answer or until he decides that the individual who was asked the question is not going to reply. In a 485 network the “master” will start the “conversation” with a “query” addressed to a specific “slave”, the “master” will then listen for the “slave’s” response. If the “slave” does not respond within a pre-defined period, (set by control software in the “master”), the “master” will abandon the “conversation”.

11.3.2 Connecting the instruments

Screened twisted pair cable should be used. For longer cable runs or noisier environments, use of a cable specifically designed for RS485 may be necessary to achieve optimum performance. All “A” terminals should be connected together using one conductor of the twisted pair cable, all “B” terminals should be connected together using the other conductor in the pair. A line as described in (→  39) or any other line with equal specification and a characteristic impedance of 120 Ω is recommended. The cable should be terminated at each end with a 120 Ω , min. 0.25 W, resistor and a capacitor with 1 nF in series with the resistor.

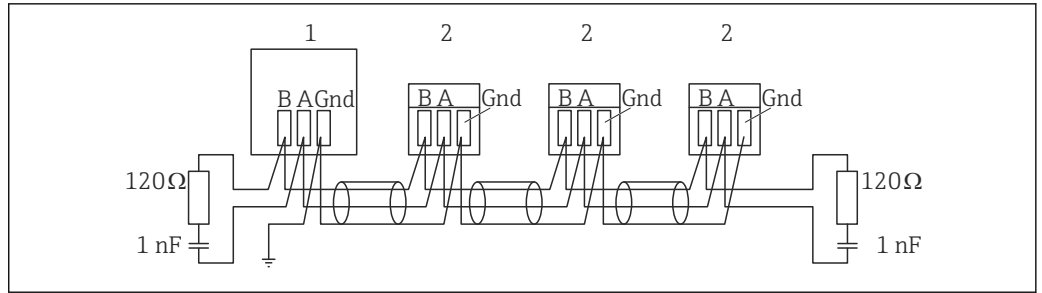

A0016443

14 Modbus connection
 1 Modbus Master
 2 EngyVolt Modbus Slave

There must be no more than two wires connected to each terminal, this ensures that a “Daisy Chain or “straight line” configuration is used. A “Star” or a network with “Stubs (Tees)” is not recommended as reflections within the cable may result in data corruption.

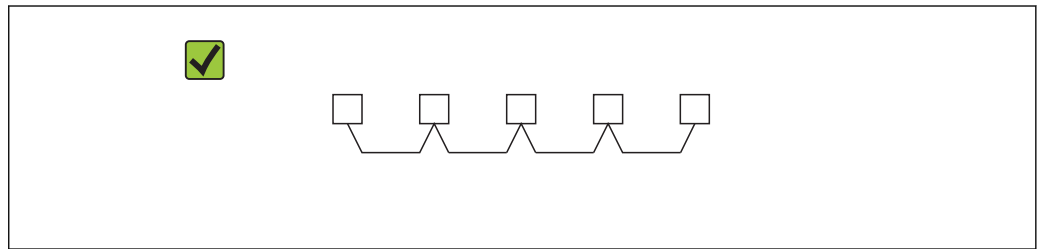

A0016444

15 Correct straight line connection

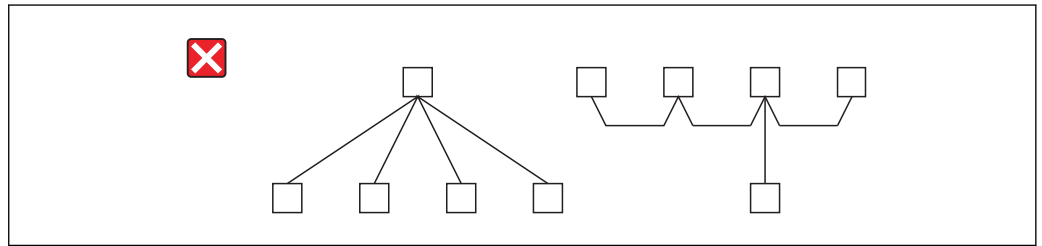

A0016445

16 Incorrect star or stubs connection

11.3.3 A and B terminals

The A and B connections to the EngyVolt devices can be identified by the signals present on them whilst there is activity on the RS485 bus.

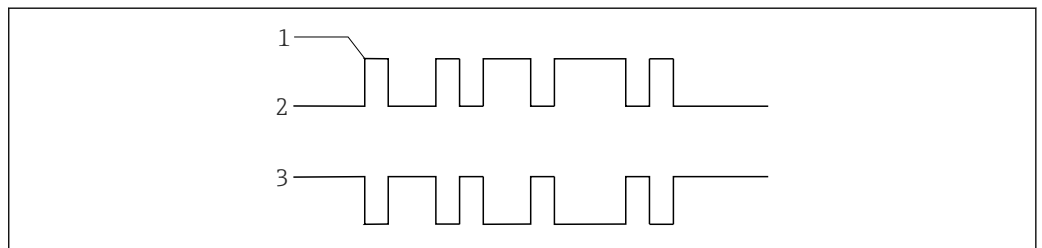

A0016446

17 RS485 signal
 1 Start bit
 2 Idle State (A) = no signal level on A
 3 Idle State (B) = no signal level on

11.3.4 Troubleshooting

This section contains general information. Specific notes for your individual system can be obtained from the technical support of the software used or from your system integrator.

- Start with a simple network, one master and one slave. With EngyVolt devices this is easily achieved as the network can be left intact whilst individual instruments are disconnected by removing the RS485 connection from the instrument.
- Check that the network is connected together correctly as described in (→  46).
- Confirm that the data “transmitted” onto the RS485 is not echoed back to the PC on the RS232 lines. (This facility is sometimes a link option within the converter). Many PC based packages seem to not perform well when they receive an echo of the message they are transmitting.
- Confirm that the address of the instrument is the same as the “master” is expecting.
- If the “network” operates with one instrument but not more than one check that each instrument has a unique address.
- Each request for data must be restricted to 40 parameters. Violating this requirement will impact the performance of the instrument and may result in a response time in excess of the specification.
- Check that the Modbus Protocol mode (RTU or ASCII) and serial parameters (baud rate, number of data bits, number of stop bits and parity) are the same for all devices on the network.
- Check that the “master” is requesting floating-point variables (pairs of registers placed on floating point boundaries) and is not “splitting” floating point variables.
- Check that the floating-point byte order expected by the “master” is the same as that used by EngyVolt device. (Various software systems can use a number of formats.)
- If possible obtain a second RS232 to RS485 converter and connect it between the RS485 bus and an additional PC equipped with a software package, which can display the data on the bus. Check for the existence of valid requests.
- Especially for converters with USB connection, experience has shown that data transmission may be incorrect. Due to the variety of converters on the market a general type recommendation cannot be made. Use of a RS485/RS232 converter for connection to the serial PC interface is recommended.

11.4 Modbus protocol general information

Communication on a Modbus Protocol Network is initiated (started) by a “Master” sending a query to a “Slave”. The “Slave”, which is constantly monitoring the network for queries addressed to it, will respond by performing the requested action and sending a response back to the “Master”. Only the “Master” can initiate a query.

In the Modbus Protocol the master can address individual slaves, or, using a special “Broadcast” address, can initiate a broadcast message to all slaves. The EngyVolt devices do not support the broadcast address.

11.4.1 Modbus data format

The Modbus Protocol defines the format for the master’s query and the slave’s response. The query contains the device (or broadcast) address, a function code defining the requested action, any data to be sent, and an error-checking field. The response contains fields confirming the action taken, any data to be returned, and an error-checking field. If an error occurred in receipt of the message then the message is ignored, if the slave is unable to perform the requested action, then it will construct an error message and send it as its response. The Modbus Protocol functions used by the EngyVolt devices copy 16 bit register values between master and slaves. However, the data used by the EngyVolt device is in 32 bit IEEE 754 floating point format. Thus each instrument parameter is conceptually held in two adjacent Modbus Protocol registers.

Query

The following example illustrates a request for a single floating point parameter i.e. two 16-bit Modbus Protocol Registers.

First Byte							Last Byte
"Slave" address	Function code	Start address (Hi)	Start address (Lo)	Number of points (Hi)	Number of points (Lo)	Error check (Lo)	Error check (Hi)

"Slave" address:

8-bit value representing the slave being addressed (1 to 247), 0 is reserved for the broadcast address. The EngyVolt devices do not support the broadcast address.

Function code:

8-bit value telling the addressed slave what action is to be performed. (3, 4, 8 or 16 are valid)

Start address (Hi):

The top (most significant) eight bits of a 16-bit number specifying the start address of the data being requested.

Start address (Lo):

The bottom (least significant) eight bits of a 16-bit number specifying the start address of the data being requested. As registers are used in pairs and start at zero, then this must be an even number.

Number of points (Hi):

The top (most significant) eight bits of a 16-bit number specifying the number of registers being requested.

Number of points (Lo):

The bottom (least significant) eight bits of a 16-bit number specifying the number of registers being requested. As registers are used in pairs, then this must be an even number.

Error check (Lo):

The bottom (least significant) eight bits of a 16-bit number representing the error check value.

Error check (Hi):

The top (most significant) eight bits of a 16-bit number representing the error check value.

Response

The example illustrates the normal response to a request for a single floating point parameter i.e. two 16-bit Modbus Protocol Registers.

First Byte							Last Byte	
"Slave"	Function code	Byte count	First register (Hi)	First register (Lo)	Second register (Hi)	Second register (Lo)	Error check (Lo)	Error check (Hi)

"Slave" address:

8-bit value representing the address of slave that is responding.

Function code:

8-bit value which, when a copy of the function code in the query, indicates that the slave recognized the query and has responded. (See also Exception Response (→ 50)).

Byte count:

8-bit value indicating the number of data bytes contained within this response

First register (Hi)²⁾:

The top (most significant) eight bits of a 16-bit number representing the first register requested in the query.

First register (Lo)²⁾:

The bottom (least significant) eight bits of a 16-bit number representing the first register requested in the query.

Second register (Hi)²⁾:

The top (most significant) eight bits of a 16-bit number representing the second register requested in the query.

Second register (Lo)²⁾:

The bottom (least significant) eight bits of a 16-bit number representing the second register requested in the query.

Error check (Lo):

The bottom (least significant) eight bits of a 16-bit number representing the error check value.

Error check (Hi)²⁾:

The top (most significant) eight bits of a 16-bit number representing the error check value.

Exception response

If an error is detected in the content of the query (excluding parity errors and error check mismatch), then an error response (called an exception response), will be sent to the master. The exception response is identified by the function code being a copy of the query function code but with the most-significant bit set. The data contained in an exception response is a single byte error code.

First Byte				Last Byte
"Slave" address	Function code	Error code	Error check (Lo)	Error check (Hi)

"Slave" address:

8-bit value representing the address of slave that is responding.

²⁾ Together, these four bytes represent the value of the floating point parameter requested in the query.

Function code:

8 bit value which is the function code in the query OR'ed with 80 hex, indicating that the slave either does not recognize the query or could not carry out the action requested.

Error code:

-bit value indicating the nature of the exception detected, see table of error codes (→ 59).

Error check (Lo):

The bottom (least significant) eight bits of a 16-bit number representing the error check value.

Error check (Hi):

The top (most significant) eight bits of a 16-bit number representing the error check value.

11.4.2 Serial transmission modes

There are two Modbus Protocol serial transmission modes, ASCII and RTU. EngyVolt devices do not support the ASCII mode.

In RTU (Remote Terminal Unit) mode, each 8-bit byte is used in the full binary range and is not limited to ASCII characters as in ASCII Mode. The greater data density allows better data throughput for the same baud rate, however each message must be transmitted in a continuous stream. This is very unlikely to be a problem for modern communications equipment.

Coding system	Full 8-bit binary per byte. In this document, the value of each byte will be shown as two hexadecimal characters each in the range 0-9 or A-F.
Line protocol	1 start bit, followed by the 8 data bits. The 8 data bits are sent with least significant bit first.
User option of parity and stop bits:	a) no parity & 2 stop bits b) no parity & 1 stop bit c) even parity & 1 stop bit d) odd parity & 1 stop bit
User option of baud rate	a) 2 400 b) 4 800 c) 9 600 d) 19 200

The baud rate, parity and stop bits must be selected to match the master's settings.

11.4.3 Modbus protocol message timing

A Modbus protocol message has defined beginning and ending points. The receiving device recognizes the start of the message, reads the "Slave Address" to determine if they are being addressed and knowing when the message is completed they can use the Error Check bytes and parity bits to confirm the integrity of the message. If the Error Check or parity fails then the message is discarded.

In RTU mode, messages start with a silent interval of at least 3.5 character times. The first byte of a message is then transmitted, the device address. Master and slave devices monitor the network continuously, including during the 'silent' intervals. When the first byte (the address byte) is received, each device checks it to find out if it is the addressed device. If the device determines that it is the one being addressed it records the whole message and acts accordingly, if it is not being addressed it continues monitoring for the next message.

Following the last transmitted byte, a silent interval of at least 3.5 character times marks the end of the message. A new message can begin after this interval.

The entire message must be transmitted as a continuous stream. If a silent interval of more than 2.5 character times occurs before completion of the message, the receiving device flushes the incomplete message and assumes that the next byte will be the address byte of a new message. Similarly, if a new message begins earlier than 3.5 character times following a previous message, the receiving device may consider it a continuation of the previous message. This will result in an error, as the value in the final CRC field will not be valid for the combined messages.

11.4.4 How characters are transmitted serially

When messages are transmitted on standard Modbus protocol serial networks each byte is sent in this order (left to right):

Transmit Character = Start Bit + Data Byte + Parity Bit + 1 Stop Bit (11 bits total):

	Least Significant Bit (LSB)							Most Significant Bit (MSB)		
Start	1	2	3	4	5	6	7	8	Parity	Stop

Transmit Character = Start Bit + Data Byte + 2 Stop Bits (11 bits total):

	Least Significant Bit (LSB)							Most Significant Bit (MSB)		
Start	1	2	3	4	5	6	7	8	Stop	Stop

Transmit Character = Start Bit + Data Byte + 1 Stop Bit (10 bits total):

	Least Significant Bit (LSB)							Most Significant Bit (MSB)	
Start	1	2	3	4	5	6	7	8	Stop

The master is configured by the user to wait for a predetermined timeout interval. The master will wait for this period of time before deciding that the slave is not going to respond and that the transaction should be aborted. Care must be taken when determining the timeout period from both the master and the slaves' specifications. The slave may define the 'response time' as being the period from the receipt of the last bit of the query to the transmission of the first bit of the response. The master may define the 'response time' as period between transmitting the first bit of the query to the receipt of the last bit of the response. It can be seen that message transmission time, which is a function of the baud rate, must be included in the timeout calculation.

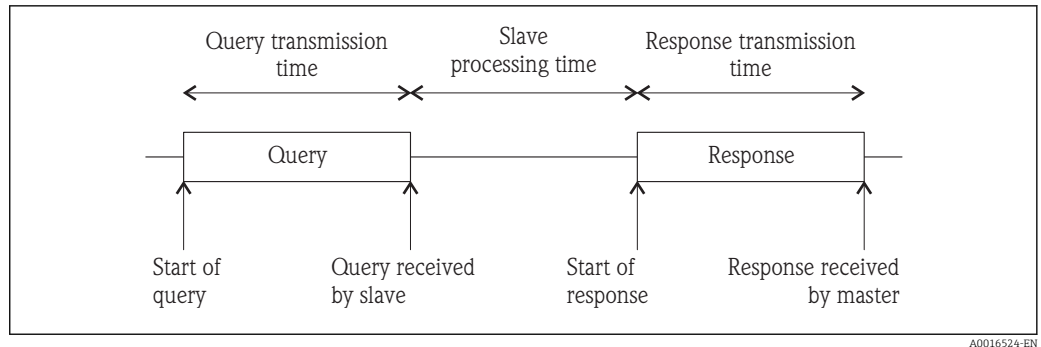

18 Modbus data transmission

11.4.5 Error checking methods

Standard Modbus protocol serial networks use two error checking processes, the error check bytes mentioned above check message integrity whilst Parity checking (even or odd) can be applied to each byte in the message.

Parity checking

If parity checking is enabled – by selecting either Even or Odd Parity - the quantity of “1’s” will be counted in the data portion of each transmit character. The parity bit will then be set to a 0 or 1 to result in an Even or Odd total of “1’s”.

Note that parity checking can only detect an error if an odd number of bits are picked up or dropped in a transmit character during transmission, if for example two 1’s are corrupted to 0’s the parity check will not find the error. If No Parity checking is specified, no parity bit is transmitted and no parity check can be made. Also, if No Parity checking is specified and one stop bit is selected the transmit character is effectively shortened by one bit.

CRC checking

The error check bytes of the Modbus Protocol messages contain a Cyclical Redundancy Check (CRC) value that is used to check the content of the entire message. The error check bytes must always be present to comply with the Modbus Protocol, there is no option to disable it. The error check bytes represent a 16-bit binary value, calculated by the transmitting device. The receiving device must recalculate the CRC during receipt of the message and compare the calculated value to the value received in the error check bytes. If the two values are not equal, the message should be discarded.

The error check calculation is started by first pre-loading a 16-bit register to all 1’s (i.e. Hex (FFFF)) each successive 8-bit byte of the message is applied to the current contents of the register.

i Only the eight bits of data in each transmit character are used for generating the CRC, start bits, stop bits and the parity bit, if one is used, are not included in the error check bytes. During generation of the error check bytes, each 8-bit message byte is exclusive OR’ed with the lower half of the 16 bit register.

The register is then shifted eight times in the direction of the least significant bit (LSB), with a zero filled into the most significant bit (MSB) position. After each shift the LSB prior to the shift is extracted and examined. If the LSB was a 1, the register is then exclusive OR’ed with a pre-set, fixed value. If the LSB was a 0, no exclusive OR takes place. This process is repeated until all eight shifts have been performed. After the last shift, the next 8-bit message byte is exclusive OR’ed with the lower half of the 16 bit register, and the process repeated. The final contents of the register, after all the bytes of the message have been applied, is the error check value. In the following pseudo code “ErrorWord” is a 16-bit value representing the error check values.

BEGIN

ErrorWord = Hex (FFFF)

```

FOR Each byte in message
  ErrorWord = ErrorWord XOR byte in message
  FOR Each bit in byte
    LSB = ErrorWord AND Hex (0001)
    IF LSB = 1 THEN ErrorWord = ErrorWord - 1
    ErrorWord = ErrorWord / 2
    IF LSB = 1 THEN ErrorWord = ErrorWord XOR Hex (A001)
  NEXT bit in byte
NEXT Byte in message
END

```

11.4.6 Function codes

The function code part of a Modbus Protocol message defines the action to be taken by the slave. EngyVolt devices support the following function codes:

Code	Modbus protocol name	Description
03	Read Holding Registers	Read the contents of read/write location (4X references).
04	Read Input Registers	Read the contents of read only location (3X references).
08	Diagnostics	Only sub-function zero is supported. This returns the data element of the query unchanged.
16	Pre-set Multiple Registers	Set the contents of read/write location (4X references).

11.4.7 IEEE floating point format

The Modbus Protocol defines 16 bit “Registers” for the data variables. A 16-bit number would prove too restrictive, for energy parameters for example, as the maximum range of a 16-bit number is 65535. However, there are a number of approaches that have been adopted to overcome this restriction. Integra Digital meters use two consecutive registers to represent a floating-point number, effectively expanding the range to $\pm 1 \times 10^{37}$.

The values produced by EngyVolt devices can be used directly without any requirement to “scale” the values, for example, the units for the voltage parameters are volts, the units for the power parameters are watts etc.

What is a floating point number?

A floating-point number is a number with two parts, a mantissa and an exponent and is written in the form 1.234×10^5 . The mantissa (1.234 in this example) must have the decimal point moved to the right with the number of places determined by the exponent (5 places in this example) i.e. $1.234 \times 10^5 = 123\,400$.

If the exponent is negative the decimal point is moved to the left.

What is an IEEE 754 format floating-point number?

An IEEE 754 floating point number is the binary equivalent of the decimal floating-point number shown above. The major difference being that the most significant bit of the mantissa is always arranged to be 1 and is thus not needed in the representation of the number. The process by which the most significant bit is arranged to be 1 is called normalisation, the mantissa is thus referred to as a “normal mantissa”. During normalisation the bits in the mantissa are shifted to the left whilst the exponent is decremented until the most significant bit of the mantissa is one. In the special case where

the number is zero both mantissa and exponent are zero. The bits in an IEEE 754 format have the following significance:

Data Hi Reg, Hi Byte.	Data Hi Reg, Lo Byte.	Data Lo Reg, Hi Byte.	Data Lo Reg, Lo Byte.
SEEE EEEE	EMMM MMMM	MMMM MMMM	MMMM MMMM

Where:

S = represents the sign bit where 1 is negative and 0 is positive

E = is the 8-bit exponent with an offset of 127 i.e. an exponent of zero is represented by 127, an exponent of 1 by 128 etc.

M = the 23-bit normal mantissa. The 24th bit is always 1 and, therefore, is not stored.

Using the above format the floating point number 240.5 is represented as 43708000 hex:

Data Hi Reg, Hi Byte.	Data Hi Reg, Lo Byte.	Data Lo Reg, Hi Byte.	Data Lo Reg, Lo Byte.
43	70	80	00

The following example demonstrates how to convert IEEE 754 floating-point numbers from their hexadecimal form to decimal form. For this example, we will use the value for 240.5240.5 shown above.

 The floating-point storage representation is not an intuitive format. To convert this value to decimal, the bits should be separated as specified in the floating-point number storage format table shown above.

For example:

Data Hi Reg, Hi Byte.	Data Hi Reg, Lo Byte.	Data Lo Reg, Hi Byte.	Data Lo Reg, Lo Byte.
0100→0011	0111→0000	1000→0000	0000→0000

From this you can determine the following information.

- The sign bit is 0, indicating a positive number.
- ▪ The exponent value is 10000110 binary or 134 decimal. Subtracting 127 from 134 leaves 7, which is the actual exponent.
- ▪ The mantissa appears as the binary number 11100001000000000000000

There is an implied binary point at the left of the mantissa that is always preceded by a 1. This bit is not stored in the hexadecimal representation of the floating-point number. Adding 1 and the binary point to the beginning of the mantissa gives the following: 1.111000010000000000000000

Now, we adjust the mantissa for the exponent. A negative exponent moves the binary point to the left. A positive exponent moves the binary point to the right. Because the exponent is 7, the mantissa is adjusted as follows: 11110000.1000000000000000.

Finally, we have a binary floating-point number.

Binary bits that are to the left of the binary point represent the power of two corresponding to their position. The result is the following decimal value:

$$.11110000 = (1 \times 2^7) + (1 \times 2^6) + (1 \times 2^5) + (1 \times 2^4) + (0 \times 2^3) + (0 \times 2^2) + (0 \times 2^1) + (0 \times 2^0) = 240$$

Binary bits that are to the right of the binary point also represent a power of 2 corresponding to their position. As the digits are to the right of the binary point the powers are negative. For example: .100... = $(1 \times 2^{-1}) + (0 \times 2^{-2}) + (0 \times 2^{-3}) + \dots = 0.5$

Adding these two numbers together and making reference to the sign bit produces the number +240.5.

For each floating point value requested two Modbus Protocol registers (four bytes) must be requested. The received order and significance of these four bytes for EbgyVolt devices is shown below:

Data Hi Reg, Hi Byte.	Data Hi Reg, Lo Byte.	Data Lo Reg, Hi Byte.	Data Lo Reg, Lo Byte.
-----------------------	-----------------------	-----------------------	-----------------------

11.4.8 Modbus commands supported

All EngyVolt devices support the “Read Input Register” (3X registers), the “Read Holding Register” (4X registers) and the “Pre-set Multiple Registers” (write 4X registers) commands of the MODBUS Protocol RTU protocol. All values stored and returned are in floating point format to IEEE 754 with the most significant register first.

Read input registers

MODBUS Protocol code 04 reads the contents of the 3X registers.

Example: The following query will request ‘Volts 1’ from an instrument with node address 1:

Field name	Example (Hex)
Slave address	01
Function	04
Starting address High	00
Starting address Low	00
Number of points High	00
Number of points Low	02
Error check Low	71
Error check High	CB

 Data must be requested in register pairs i.e. the “Starting Address” and the “Number of Points” must be even numbers to request a floating point variable. If the “Starting Address” or the “Number of points” is odd then the query will fall in the middle of a floating point variable the product will return an error message.

The following response returns the contents of Volts 1 as 230.2.

But see also “Exception Response” later.

Field name	Example (Hex)
Slave address	01
Function	04
Byte count	04
Data, High Reg, High Byte	43
Data, High Reg, Low Byte	66
Data, Low Reg, High Byte	33
Data, Low Reg, Low Byte	34
Error check Low	1B
Erorr check High	38

11.4.9 Holding registers

Read holding registers

MODBUS Protocol code 03 reads the contents of the 4X registers.

Example: The following query will request the prevailing 'Demand Time':

Field name	Example (Hex)
Slave address	01
Function	03
Starting address High	00
Starting address Low	00
Number of points High	00
Number of points Low	02
Error check Low	C4
Error check High	0B

 Data must be requested in register pairs i.e. the "Starting Address" and the "Number of Points" must be even numbers to request a floating point variable. If the "Starting Address" or the "Number of points" is odd then the query will fall in the middle of a floating point variable the product will return an error message.

The following response returns the contents of Demand Time as 1, But see also "Exception Response" later.

Field name	Example (Hex)
Slave address	01
Function	03
Byte count	04
Data, High Reg, High Byte	3F
Data, High Reg, Low Byte	80
Data, Low Reg, High Byte	00
Data, Low Reg, Low Byte	00
Error check Low	F7
Error check High	CF

Write holding registers

MODBUS Protocol code 10 (16 decimal) writes the contents of the 4X registers.

The following query will set the Demand Period to 60, which effectively resets the Demand Time:

Field name	Example (Hex)
Slave address	01
Function	10
Starting address High	00
Starting address Low	00
Number of registers High	00
Number of registers Low	02

Field name	Example (Hex)
Byte count	04
Data, High Reg, High Byte	00
Data, High Reg, Low Byte	00
Data, Low Reg, High Byte	00
Data, Low Reg, Low Byte	00
Error check Low	F2
Error check High	AF

i Data must be written in register pairs i.e. the “Starting Address” and the “Number of Points” must be even numbers to write a floating point variable. If the “Starting Address” or the “Number of points” is odd then the query will fall in the middle of a floating point variable the product will return an error message.

In general only one floating point value can be written per query.

The following response indicates that the write has been successful. But see also “Exception Response” later.

Field name	Example (Hex)
Slave address	01
Function	10
Starting address High	00
Starting address Low	00
Number of registers High	00
Number of registers Low	02
Error check Low	41
Error check High	C8

11.4.10 Exception response

If the slave in the “Write Holding Register” example above, did not support that function then it would have replied with an Exception Response as shown below. The exception function code is the original function code from the query with the MSB set i.e. it has had 80 hex logically OR'ed with it. The exception code indicates the reason for the exception. The slave will not respond at all if there is an error with the parity or CRC of the query. However, if the slave can not process the query then it will respond with an exception. In this case a code 01, the requested function is not support by this slave.

Field name	Example (Hex)
Slave address	01
Function	10 OR 80 = 90
Exception code	01
Error check Low	8D
Error check High	C0

11.4.11 Exception codes

Table of exception codes

Exception code	Modbus protocol name	Description
01	Illegal function	The function code is not supported by the product.
02	Illegal data address	Attempt to access an invalid address or an attempt to read or write part of a floating point value.
03	Illegal data value	Attempt to set a floating point variable to an invalid value.
05	Slave device failure	An error occurred when the instrument attempted to store an update to its configuration.

11.4.12 Diagnostics

MODBUS Protocol code 08 provides a number of diagnostic sub-functions. Only the “Return Query Data” sub-function (sub-function 0) is supported on EngyVolt devices.

Example:

The following query will send a diagnostic “return query data” query with the data elements set to Hex(AA) and Hex(55) and will expect these to be returned in the response:

Field name	Example (Hex)
Slave address	01
Function	08
Sub-function High	00
Sub-function Low	00
Data byte 1	AA
Data byte 2	55
Error check Low	5E
Error check High	94

Exactly one register of data (two bytes) must be sent with this function.

The following response indicates the correct reply to the query, i.e. the same bytes as the query.

Field name	Example (Hex)
Slave address	01
Function	08
Sub-function High	00
Sub-function Low	00
Data byte 1	AA
Data byte 2	55
Error check Low	5E
Error check High	94

11.5 RS485 Implementation of Johnson Controls Metasys

These notes briefly explain Metasys and EngyVolt device integration. Use these notes with the Metasys Technical Manual, which provides information on installing and commissioning Metasys N2 Vendor devices.

11.5.1 Application details

The EngyVolt multifunctional electrical energy meter is an N2 Vendor device that connects directly with the Metasys N2 Bus. This implementation assigns key electrical parameters to ADF points, each with override capability.

Components requirements:

- EngyVolt device with RS485 card and N2 port available.
- N2 bus cable

Metasys release requirements

- Metasys Software Release 12.04 or later
- NCM-361-8 or Metasys Extended Architecture NAE35,NAE45,NAE55

EngyVolt devices may be compatible with earlier releases of N2 software, but Johnson Controls only supports integration issues on the above.

Support for Metasys integration

Please contact the nearest Johnson Controls Energy Efficiency or Johnson Controls System & Services representative. The address can be found on the Johnson Controls website.

Design considerations

When integrating the EngyVolt device equipment into a Metasys Network, keep the following considerations in mind.

Make sure all EngyVolt device equipment is set up, started and running properly before attempting to integrate with the Metasys Network.

A maximum of 32 devices can be connected to any one NCM N2 Bus segment, or up to 100 devices if repeaters are used.

From the instrument set-up screen, the Coms option must be set to N2, then the address set to the required value. All port settings will then be set automatically, see below.

Device address	1 to 255
Port set up:	
Baud rate ¹⁾	9600
Duplex	Half
Word length	8
Stop bits ¹⁾	1
Parity ¹⁾	no
Interface	RS485

- 1) The user has to make sure that the values given are set up in the EngyVolt device in order to ensure compatibility with the N2 protocol network.

11.5.2 EngyVolt Metasys N2 point mapping table

Name	Description	Unit	ADF point
V1	Phase 1 line to neutral volts	V	1
V2	Phase 2 line to neutral volts	V	2
V3	Phase 3 line to neutral volts	V	3
A1	Phase 1 current	A	4
A2	Phase 2 current	A	5
A3	Phase 3 current	A	6
KP1	Phase 1 power	kW	7
KP2	Phase 2 power	kW	8
KP3	Phase 3 power	kW	9
KVA1	Phase 1 volt amps	kVA	10
KVA2	Phase 2 volt amps	kVA	11
KVA3	Phase 3 volt amps	kVA	12
KVAR1	Phase 1 volt amps reactive	kvar	13
KVAR2	Phase 2 volt amps reactive	kvar	14
KVAR3	Phase 3 volt amps reactive	kvar	15
PF1	Phase 1 power factor	-	16
PF2	Phase 2 power factor	-	17
PF3	Phase 3 power factor	-	18
PA1	Phase 1 phase angle	Degrees	19
PA2	Phase 2 phase angle	Degrees	20
PA3	Phase 3 phase angle	Degrees	21
AN	Neutral current	A	22
V12	Line voltage P1-P2	V	23
V23	Line voltage P2-P3	V	24
V31	Line voltage P3-P1	V	25
VLNAVG	Average line to neutral volts	V	26
AAVG	Average current	A	27
ASUM	Total system current THD V3	A	28
VLLAVG	Average line voltage	V	29
KPSUM	Total system power	kW	30
KVASUM	Total system volt amps	kVA	31
KVARSUM	Total system Var	kvar	32
PFTOT	Total system power factor	-	33
PATOT	Total system phase angle	Degrees	34
FREQ	Frequency	Hz	35
LO_EGY_IMP_POW*	Imported Wh, lower value	0.1 kWh	36
HI_EGY_IMP_POW*	Imported Wh, higher value	100 MWh	37
LO_EGY_EXP_POW*	Exported Wh, lower value	0.1 kWh	38

* The values represented refer to the prefix "k" for energy values. For prefix "M" they are larger by factor 1000.

Name	Description	Unit	ADF point
HI_EGY_EXP_POW*	Exported Wh, higher value	100 MWh	39
LO_EGY_IMP_VAR*	Imported Varh, lower value	0.1 kvarh	40
HI_EGY_IMP_VAR*	Imported Varh, higher value	100 Mvarh	41
LO_EGY_EXP_VAR*	Exported Varh, lower value	0.1 kvarh	42
HI_EGY_EXP_VAR*	Exported Varh, higher value	100 Mvarh	43
LO_EGY_VA*	VAh, lower value	0.1 kVAh	44
HI_EGY_VA*	VAh, higher value	100 MVAh	45
LO_EGY_AMP*	Ah, lower value	0.1 Ah	46
HI_EGY_AMP*	Ah, higher value	100 kAh	47
KPSUM_DMD	Total system power demand	kW	48
KPSUM_MAX_DMD	Maximum total system power demand	kW	49
KVASUM_DMD	Maximum total system power demand	kVA	50
KVASUM_MAX_DMD	Maximum total system VA demand	kVA	51
A1_DMD	Phase 1 current demand	A	52
A1_MAX_DMD	Maximum phase 1 current demand	A	53
A2_DMD	Phase 2 current demand	A	54
A2_MAX_DMD	Maximum phase 2 current demand	A	55
A3_DMD	Phase 3 current demand	A	56
A3_MAX_DMD	Maximum phase 1 current demand	A	57
AN_DMD	Neutral current demand	A	58
AN_MAX_DMD	Maximum neutral current demand	A	59
V1_THD	Line 1 to neutral volts THD	%	60
V2_THD	Line 2 to neutral volts THD	%	61
V3_THD	Line 3 to neutral volts THD	%	62
VLNAV_G_THD	Line to neutral volts THD average	%	63
V12_THD	Line 1 to line 2 volts THD	%	64
V23_THD	Line 2 to line 3 volts THD	%	65
V31_THD	Line 3 to line 1 volts THD	%	66
VLLAVG_THD	Line to line volts THD average	%	67
A1_THD	Phase 1 Current THD	%	68
A2_THD	Phase 2 Current THD	%	69
A3_THD	Phase 3 Current THD	%	70
AAVG_THD	Phase Current THD average	%	71
RESET	Reset	-	72

* The values represented refer to the prefix "k" for energy values. For prefix "M" they are larger by factor 1000.

In order to generate a reset, write the following values to the register "RESET".

Reset	Write
All energy values (electrical energy values)	1011
All demand average / maximum values	1012
Demand time base	1013

 ADF points are one-based in the JCI compliance test software but zero-based on the network.

Index

- 0 ... 9**
 3-phase, 3-wire 13
 3-phase, 4-wire 15
- A**
 Addr 25
- B**
 bAUd 25
- C**
 Calling up the Setup menu 23, 23
 CHNG PASS 23
 COMS 24
 Configuration example
 Current transformer primary value 22
 CT 24
- D**
 Device settings 23
 Changing the password 23
 Communication settings 24
 Current transformer primary value 24
 Energy values 27
 Integration time for recording maximum values 24
 Protocol 25
 Pulse length 26
 Pulse rate 26
 Relay output 26
 Reset 24
 Self-test 27
 Setting the baud rate 25
 Setting the device address 25
 Setting the floating point 26
 Setting the parity 25
 Software version 27
 Stop bits 25
 System configuration 24
 dIT 24
 Drag indicator 38
- E**
 Electrical connection
 3-phase, 3-wire 13
 3-phase, 4-wire 15
 Single-phase, 2-wire 13
 Energy resolution 38
 Entering numbers 20
- I**
 Installation
 Extension modules 11
- M**
 Maximum demand 38
 Maximum indicator function 24
 Measuring device
 Return 29
 Metasys
 Design considerations 60
 Metasys N2
 Application details 60
 Point mapping table 61
 Requirements 60
 Modbus
 A and B terminals 47
 Commands 56
 Connecting the instruments 46
 Data coding 40
 Data format 48
 Diagnostics 59
 Error checking methods 53
 Exception codes 59
 Exception response 50, 58
 Function codes 54
 Half duplex 46
 Holding registers 43, 57
 IEEE floating point format 54
 Input registers 41
 Message timing 51
 Modes 51
 Password 45
 Protocol overview 39
 Query 49
 Register order 45
 Response 49
 Serial data transmission 52
 Troubleshooting 48
- N**
 NRGY 27
- O**
 OP1 26
 OP2 26
 Operational safety 4
 Ordr 26
 Outputs
 Pulse output 16
 RS485 15
- P**
 PARI 25
 Phase to Phase voltages 38
 Power factor 38
 PROT 25
 PULS 26
 Pulse output 16
- R**
 RATE 26
 Reactive and Apparent Power 38
 Return 29
 RLY 26

RS485	15
RSET	24

S

Single-phase, 2-wire	13
SOFT	27
Staff	
Requirements	4
STOP	25
SYS	24

T

TEST	27
Testing the phase sequence	39
THD	39
Total harmonic distortion – THD	39

W

Workplace safety	4
------------------------	---

www.addresses.endress.com
