



Level



Pressure



Flow



Temperature



Liquid  
Analysis



Registration



Systems  
Components



Services



Solutions

## Brief Operating Instructions

# Proline Prowirl 72

## Vortex Flow Measuring System

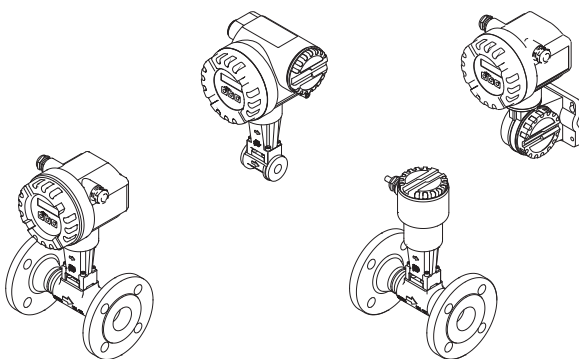

These Brief Operating Instructions are **not** intended to replace the Operating Instructions provided in the scope of supply. Detailed information is provided in the Operating Instructions and the additional documentation on the CD-ROM supplied.

Depending on the device version, the complete device documentation consists of:

- Brief Operating Instructions (this document)
- Operating Instructions
- Description of Device Functions
- Approvals and safety certificates
- Safety instructions in accordance with the approvals for the device (e.g. explosion protection, pressure equipment directive, etc.)
- Additional device-specific information

---

## Table of contents

<b>1 Safety instructions</b> .....	<b>3</b>
1.1 Designated use .....	3
1.2 Installation, commissioning and operation .....	3
1.3 Operational safety .....	3
1.4 Safety conventions .....	4
<b>2 Installation</b> .....	<b>5</b>
2.1 Transporting to the measuring point .....	5
2.2 Installation conditions .....	5
2.3 Post-installation .....	10
2.4 Post-installation check .....	13
<b>3 Wiring</b> .....	<b>14</b>
3.1 Connecting the various housing types .....	15
3.2 Special points to note when connecting the transmitter .....	17
3.3 Degree of protection .....	18
3.4 Post-connection check .....	18
<b>4 Hardware settings</b> .....	<b>19</b>
4.1 Device address .....	19
<b>5 Commissioning</b> .....	<b>21</b>
5.1 Switching on the measuring device .....	21
5.2 Operation .....	22
5.3 Navigating within the function matrix .....	22
5.4 Calling the Commissioning Quick Setup .....	24
5.5 Software settings .....	26
5.6 Troubleshooting .....	26

# 1 Safety instructions

## 1.1 Designated use



- The measuring device is used to measure the volume flow of saturated steam, superheated steam, gases and liquids. If the process pressure and process temperature are constant, the measuring device can also output the flow as the calculated mass flow and corrected volume flow.
- Any use other than that described here compromises the safety of persons and the entire measuring system and is, therefore, not permitted.
- The manufacturer is not liable for damage caused by improper or non-designated use.

## 1.2 Installation, commissioning and operation

- The measuring device must only be installed, connected, commissioned and maintained by qualified and authorized specialists (e.g. electrical technicians) in full compliance with the instructions in these Brief Operating Instructions, the applicable norms, legal regulations and certificates (depending on the application).
- The specialists must have read and understood these Brief Operating Instructions and must follow the instructions they contain. If you are unclear on anything in these Brief Operating Instructions, you must read the Operating Instructions (on the CD-ROM). The Operating Instructions provide detailed information on the measuring device.
- The measuring device should only be installed in the pipe in a de-energized state free from outside loads or strain.
- Repairs may only be performed if a genuine spare parts kit is available and this repair work is expressly permitted.
- If performing welding work on the piping, the welding unit may not be grounded by means of the measuring device.

## 1.3 Operational safety

- The measuring device is designed to meet state-of-the-art safety requirements, has been tested, and left the factory in a condition in which it is safe to operate. Relevant regulations and European standards have been observed.
- The information specified on the warning notices, nameplates and connection labels fitted on the measuring device must be observed. These contain important data, including information on the permitted operating conditions, the application of the measuring device and data on materials.
- The measuring device must be wired in accordance with the wiring diagrams and connection labels. Interconnecting must be permitted.
- All parts of the measuring device must be integrated into the potential matching system of the plant.
- The cables, tested cable glands and tested dummy plugs must suit the prevailing operating conditions, e.g. the temperature range of the process. Housing openings that are not used need to be sealed with dummy plugs.

- The measuring device can only be used in conjunction with fluids to which all the wetted parts of the measuring device are adequately resistant.  
With regard to special fluids, including fluids used for cleaning, Endress+Hauser will be happy to assist in clarifying the corrosion-resistant properties of wetted materials. However, minor changes in temperature, concentration or in the degree of contamination in the process may result in variations in corrosion resistance. Unsuitable material can lead to leakage of corrosive process media and injure personnel and/or cause damage in the plant. For this reason, Endress+Hauser does not accept any responsibility with regard to the corrosion resistance of wetted materials in a specific application. The user is responsible for the choice of suitable wetted materials in the process.
- Hazardous areas  
Measuring devices for use in hazardous areas are labeled accordingly on the nameplate. Relevant national regulations must be observed when operating the device in hazardous areas. The Ex documentation on the CD-ROM is an integral part of the entire device documentation. The installation regulations, connection data and safety instructions provided in the Ex documentation must be observed. The symbol on the front page provides information on the approval and certification body ( Europe,  USA,  Canada). The nameplate also bears the documentation number of this Ex documentation (XA\*\*\*\*\*D/../../..).
- For measuring systems used in SIL 2 applications, the separate manual on functional safety (on the CD-ROM) must be observed.
- Hygienic applications  
Measuring devices for hygienic applications have their own special labeling. Relevant national regulations must be observed when using these devices.
- Pressure instruments  
Measuring devices for use in systems that need to be monitored are labeled accordingly on the nameplate. Relevant national regulations must be observed when using these devices. The documentation on the CD-ROM for pressure instruments in systems that need to be monitored is an integral part of the entire device documentation. The installation regulations, connection data and safety instructions provided in the Ex documentation must be observed.
- Endress+Hauser will be happy to assist in clarifying any questions on approvals, their application and implementation.

## 1.4 Safety conventions



### Warning!

"Warning" indicates an action or procedure which, if not performed correctly, can result in injury or a safety hazard. Comply strictly with the instructions and proceed with care.



### Caution!

"Caution" indicates an action or procedure which, if not performed correctly, can result in incorrect operation or destruction of the device. Comply strictly with the instructions.



### Note!

"Note" indicates an action or procedure which, if not performed correctly, can have an indirect effect on operation or trigger an unexpected response on the part of the device.

## 2 Installation

### 2.1 Transporting to the measuring point

- Transport the measuring device to the measuring point in the original packaging.
- The covers or caps fitted to the process connections prevent mechanical damage to the sensors during transportation and storage. For this reason, do not remove the covers or caps until immediately before installation.

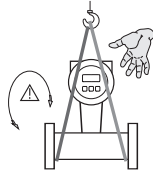

A0008731

To transport the unit, use slings slung around the process connections or use lugs (if available).

**Warning!**

Risk of injury! The device can slip. The center of gravity of the measuring device may be higher than the holding points of the slings. Always ensure that the device cannot slip or turn around its axis.



A0008732

Do not lift measuring devices by the transmitter housing or the connection housing in the case of the remote version. Do not use chains as they could damage the housing.

### 2.2 Installation conditions

It is advisable to support heavy sensors for mechanical reasons (to protect the piping).

#### 2.2.1 Dimensions

For the dimensions of the measuring device, see the associated Technical Information on the CD-ROM.

#### 2.2.2 Mounting location

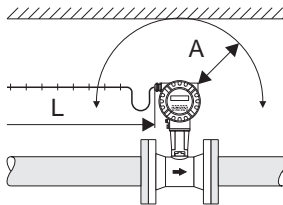

A0008733

Recommended minimum distance in all directions (A):  
100 mm (3.94 in)

Required cable length (L):  
L + 150 mm (5.91 in)

### 2.2.3 Orientation

The device can basically be installed in any position in the piping.

Please note the following points however:

- The arrow indicated on the device must **always** point in the direction of flow.
- Measuring the flow of liquids in vertical pipes:
  - There is vertical upward flow in the pipe = orientation recommended to avoid partial pipe filling (see graphic, orientation A).
  - There is vertical downward flow in the pipe = in this orientation it must be ensured that the measuring tube is always completely full.
- In order to ensure that the maximum permissible ambient temperature for the transmitter is not exceeded, the following orientations (see graphic) should be selected:
  - Orientation A, C, D → for a fluid temperature  $\geq 200\text{ }^{\circ}\text{C}$  ( $392\text{ }^{\circ}\text{F}$ )
    - ⚠ Caution!
    - If the fluid temperature is  $\geq 200\text{ }^{\circ}\text{C}$  ( $392\text{ }^{\circ}\text{F}$ ), orientation B is **not** permitted for wafer versions (Prowirl 72W) with nominal diameters DN 100 (4") and DN 150 (6").
  - Orientations A, B, D → for very cold fluids (e.g. liquid nitrogen)

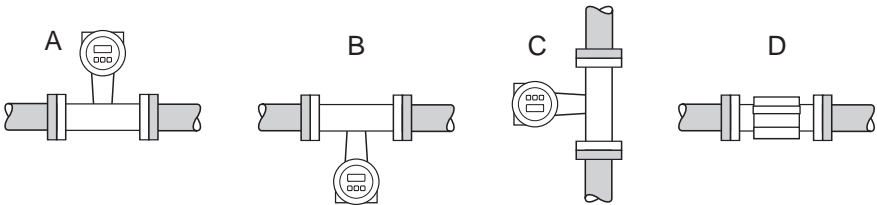

A0008734

### 2.2.4 Thermal insulation

Some fluids require suitable measures to avoid loss of heat or heat supply at the sensor. A wide range of materials can be used to provide the required thermal insulation.

When insulating, please ensure that a sufficiently large area of the housing support is exposed. The uncovered part helps heat transfer and protects the electronics from overheating (or undercooling). The maximum permitted insulation level is indicated in the following graphic (1 = flanged version, 2 = wafer version). These apply equally to both the compact version and the remote version of the sensor.

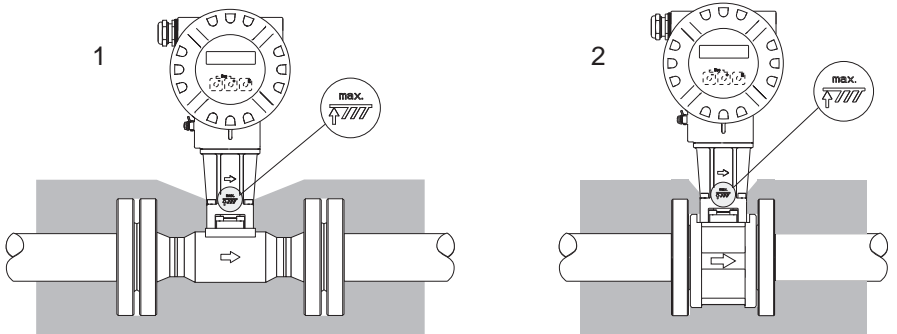

A0001868



**Caution!**

Risk of electronics overheating!

- Make sure that the adapter between the sensor and transmitter and the connection housing of the remote version are always exposed.
- Note that a certain orientation might be required, depending on the fluid temperature → 6
- For information on the permitted temperature ranges → see the Operating Instructions on the CD-ROM

### 2.2.5 Inlet and outlet runs

The following inlet and outlet runs must be taken into account. The longest inlet run shown must be observed if two or more flow disturbances are present.

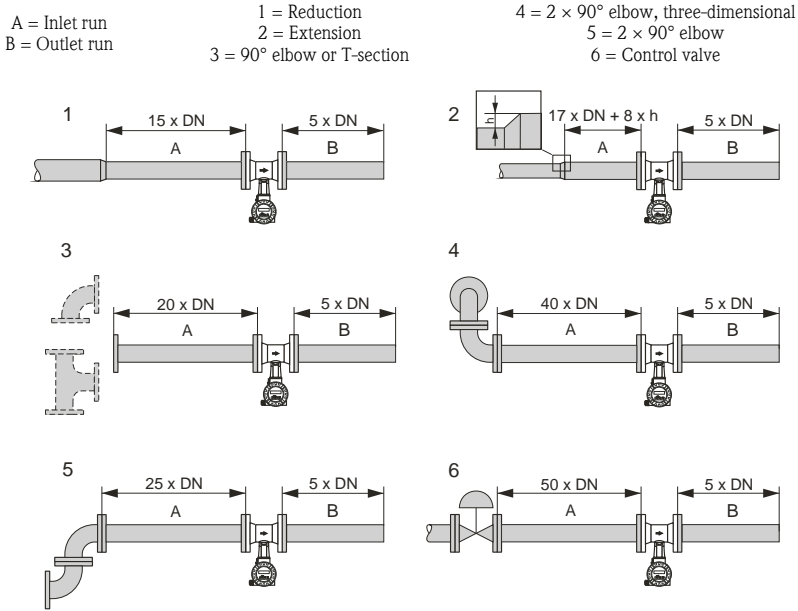

A0001867

### Perforated plate flow conditioner

A specially designed perforated plate flow conditioner, available from Endress+Hauser, can be installed if it is not possible to observe the inlet runs required. The flow conditioner is fitted between two piping flanges and centered with the mounting bolts. Generally, this reduces the inlet run required to  $10 \times DN$  with complete accuracy.

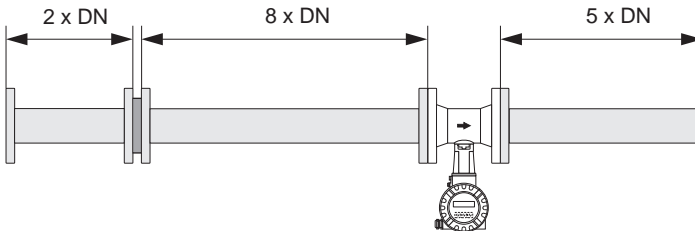

A0001887



### Outlet runs with pressure and temperature measuring points

If pressure and temperature measuring points are installed after the device, please ensure there is a large enough distance between the device and the measuring point so there are no negative effects on vortex formation in the sensor.

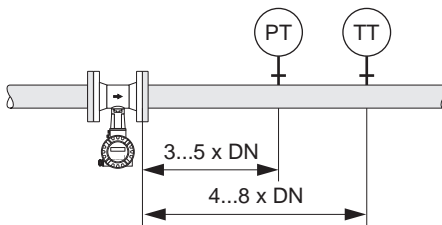

A0003780

### 2.2.6 Vibrations

The correct operation of the measuring system is not influenced by plant vibrations up to 1 g, 10 to 500 Hz. Consequently, the sensors require no special measures for attachment!

## 2.3 Post-installation

### 2.3.1 Mounting the sensor



Caution!

- Prior to installing the measuring device in the piping, remove all traces of transport packaging and any protective covers from the sensor.
- Make sure that the internal diameters of seals are the same as, or greater than, those of the measuring tube and piping. Seals projecting into the flow current have a negative effect on the vortex formation after the bluff body and cause inaccurate measurement.
- The direction of the arrow on the measuring tube must match the direction of flow.
- Lengths:
  - Prowirl W (wafer version): 65 mm (2.56 in)
  - Prowirl F (flanged version) → associated Technical Information on CD-ROM

### Mounting Prowirl W

The centering rings supplied are used to mount and center the wafer-style devices.

1 = Nut  
2 = Washer  
3 = Tie rod

4 = Centering ring  
5 = Seal

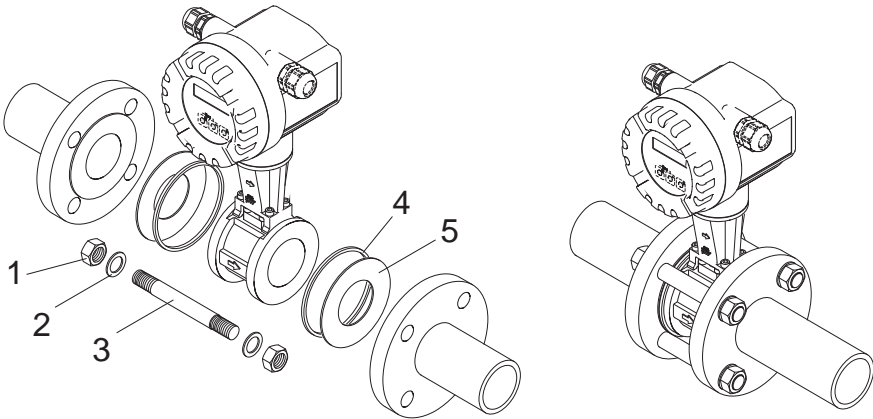

A0001888

### 2.3.2 Turning the transmitter housing

#### Turning the aluminum field housing

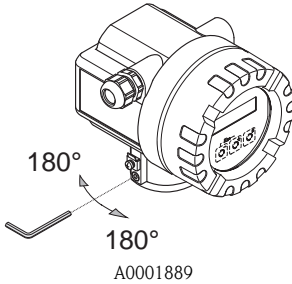

The electronics housing can be rotated continuously 360° on the housing support.

Release the lock screw.

Turn the transmitter housing to the desired position (max. 180° in each direction to the stop).



**Note!**

There are recesses in the rotating groove at 90° stages (only compact version). These help you align the transmitter more easily.

Retighten the lock screw.

### 2.3.3 Turning the onsite display

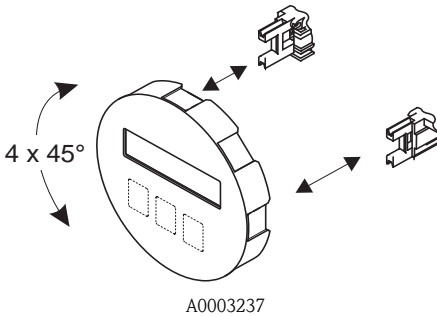

Unscrew cover of the electronics compartment from the transmitter housing.

Remove the display module from the transmitter retaining rails.

Turn the display to the desired position (max. 4 x 45° in each direction) and reset it onto the retaining rails.

Screw the cover of the electronics compartment firmly back onto the transmitter housing.

### 2.3.4 Mounting the transmitter (remote version)

#### Mounted directly on the wall

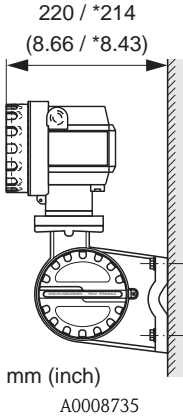

#### Pipe mounting

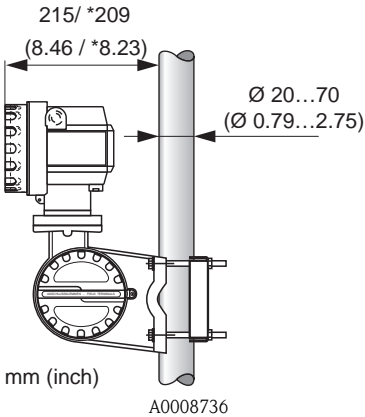

**Caution!**

If the device is mounted to a warm pipe, make sure that the housing temperature does not exceed the maximum permissible value:

**Standard:**

-40 to +80 °C (-40 to +176 °F)

**EEx d version:**

-40 to +60 °C (-40 to +140 °F)

**ATEX II 1/2 GD version/dust ignition-proof:**

-20 to +55 °C (-4 to +131 °F)

## 2.4 Post-installation check

- Is the measuring device damaged (visual inspection)?
- Does the measuring device correspond to the specifications at the measuring point?
- Is the serial number of sensor and the connected transmitter the same?
- Are the measuring point number and labeling correct (visual inspection)?
- Correct internal diameter and correct surface roughness/quality?
- Sensor orientation correctly selected in terms of type, fluid properties and fluid temperature?
- Does the arrow on the sensor point in the direction of flow in the pipe?
- Is the measuring device protected against moisture and direct sunlight?
- Is the measuring device protected against overheating?

### 3 Wiring



#### Note!

- Use a connecting cable with a continuous operation temperature between  $-40\text{ °C}$  ( $-40\text{ °F}$ ) and the max. permitted ambient temperature plus  $10\text{ °C}$  (plus  $18\text{ °F}$ ).
- Conductor cross-section: max.  $2.5\text{ mm}^2$  (14 AWG)
- A shielded connecting cable must be used.
- Route the connecting cable so it is securely seated.
- Pay particular attention to company-internal grounding concepts and national installation regulations and guidelines.
- Seal the cable entries and covers tight.



#### Caution!

Risk of damaging the electronic components!

Connect the connecting cable → in accordance with the connection data on the nameplate or the connection data in the Operating Instructions or the Ex documentation on the CD-ROM.

#### **In addition, for the remote version:**



#### Caution!

Risk of damaging the electronic components!

- Only connect sensors and transmitters with the same serial number.
- The remote version must be grounded. In doing so, the sensor and transmitter must be connected to the same potential matching.
- Observe the cable specifications of the connecting cable → Operating Instructions on the CD-ROM.



#### Note!

Install the connecting cable securely to prevent movement.

#### **In addition, for measuring devices with fieldbus communication:**



#### Caution!

Risk of damaging the electronic components!

- Observe the cable specification of the fieldbus cable → Operating Instructions on the CD-ROM.
- Keep the stripped and twisted lengths of cable shield as short as possible.
- Screen and ground the signal lines → Operating Instructions on the CD-ROM.
- If the shielding of the cable is grounded at more than one point in systems without additional potential equalization, power supply frequency equalization currents can occur that damage the cable or the shielding. In such instances, the shielding of the cable only has to be grounded on one side. This means that it may not be connected to the ground terminal of the housing. The shield that is not connected should be insulated!

**In addition, for Ex-certified measuring devices:**

**Warning!**

When wiring Ex-certified measuring devices, all the safety instructions, wiring diagrams, technical information, etc. of the related Ex documentation must be observed  
→ Ex documentation on the CD-ROM.

**3.1 Connecting the various housing types**

Wire the unit using the terminal assignment diagram inside the cover.

**3.1.1 Compact version, Ex i / non-Ex**

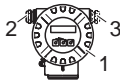

Transmitter connection:

- 1 Connection diagram in the electronics compartment
- 2 Connecting cable
- 3 For optional output with HART version

A0008737

Connection compartment, Ex i / non-Ex transmitter housing

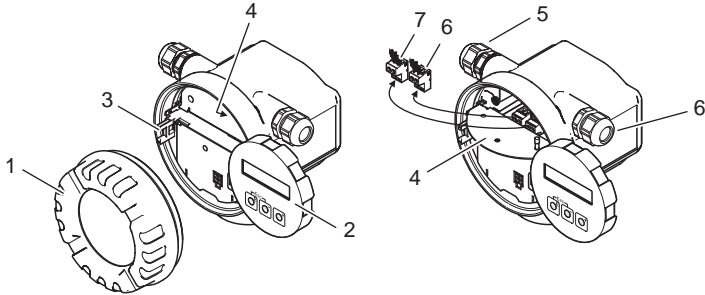

A0008738

- 1 Electronics compartment cover
- 2 Display module
- 3 Retaining rail for display module
- 4 Connection compartment cover
- 5 Cable gland for connecting cable
- 6 Cable gland for optional output for HART version
- 7 Terminal connector for connecting cable
- 8 Terminal connector for optional output for HART version

### 3.1.2 Compact version, Ex d

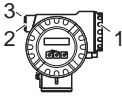

A0008739

Transmitter connection:

- 1 Connection diagram inside the connection compartment cover
- 2 Power supply cable/signal cable
- 3 Optional frequency output with HART version

#### Connection compartment, Ex d transmitter housing

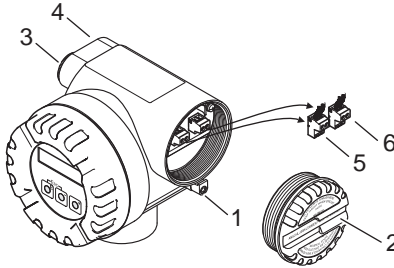

A0008742

- 1 Securing clamp for connection compartment cover
- 2 Connection compartment cover
- 3 Cable gland for connecting cable
- 4 Cable gland for optional output for HART version
- 5 Terminal connector for connecting cable
- 6 Terminal connector for optional output for HART version

### 3.1.3 Remote version (transmitter), Ex i and Ex d

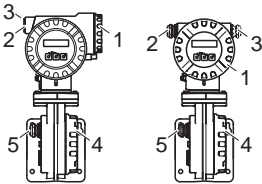

A0008744

Transmitter connection:

- 1 Connection diagram inside the connection compartment cover
- 2 Connecting cable
- 3 Optional output with HART version

Connecting cable connection:

- 4 Connection diagram inside the connection compartment cover
- 5 Sensor/transmitter connecting cable

### 3.1.4 Remote version (sensor)

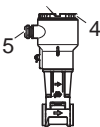

A0008754

Connecting cable connection:

- 4 Connection diagram inside the connection compartment cover
- 5 Sensor/transmitter connecting cable



### 3.2 Special points to note when connecting the transmitter

#### 3.2.1 Stripping the ground cable for fieldbuses

When connecting the ground cable in the case of fieldbuses (PROFIBUS PA and FOUNDATION Fieldbus), attention should be paid to the maximum permissible stripping length.

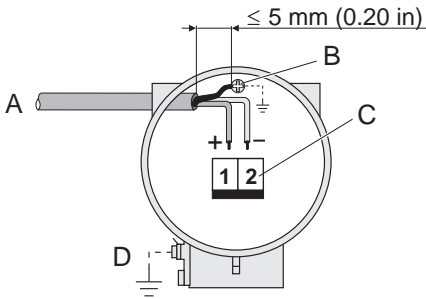

- A Fieldbus cable
- B Ground terminal  
Between the stripped fieldbus cable and the ground terminal, the cable shielding should not exceed a length of 5 mm (0.20 in)
- C Terminal connector
- D Ground terminal (external, only relevant for remote version)

A0003784

#### 3.2.2 Pulse/frequency modulation (PFM), flow computer

Connection for outputting PFM signals, flow computer → Operating Instructions on CD-ROM.

### 3.3 Degree of protection

The devices meet all the requirements for IP 67.

After mounting in the field or service work, the following points have to be observed to ensure that IP 67 protection is retained:

- Install the measuring device in such a way that the cable entries do not point upwards.
- Do not remove the seal from the cable entry.
- Remove all unused cable entries and plug them with suitable drain plugs.

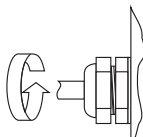

A0007549

Tighten the cable entries correctly.

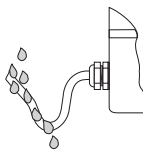

A0007550

The cables must loop down before they enter the cable entries ("water trap").

### 3.4 Post-connection check

- Are cables or the device damaged (visual inspection)?
- Does the supply voltage match the specifications on the nameplate?
- Are the power supply and signal cables connected correctly?
- Do the cables used comply with the necessary specifications?
- Do the mounted cables have adequate strain relief and are they routed securely?
- Is the cable type route completely isolated? Without loops and crossovers?
- Are all of the screw terminals correctly tightened?
- Are all the cable entries installed, firmly tightened and correctly sealed?
- Cable routed as a "water trap" in loops?
- Are all the housing covers installed and correctly tightened?

#### **In addition, for measuring devices with fieldbus communication:**

- Are all the connecting components (T-boxes, junction boxes, connectors, etc.) connected with each other correctly?
- Has each fieldbus segment been terminated at both ends with a bus terminator?
- Has the max. length of the fieldbus cable been observed in accordance with the specifications?
- Has the max. length of the spurs been observed in accordance with the specifications?
- Is the fieldbus cable fully shielded and correctly grounded?

## 4 Hardware settings

This section only deals with the hardware settings needed for commissioning. All other settings (e.g. output configuration, write protection, etc.) are described in the associated Operating Instructions on the CD-ROM.



Note!

No hardware settings are needed for measuring devices with HART and FOUNDATION Fieldbus-type communication.

### 4.1 Device address

Has to be set for measuring devices with the following communication methods:

- PROFIBUS PA

The device address can be configured via:

- Miniature switches → see description below
- Device functions/Operating program FieldCare → see Operating Instructions on the CD-ROM

## Addressing via miniature switches

### ⚠ Warning!

Risk of electric shock! Risk of damaging the electronic components!

- All the safety instructions for the measuring device must be observed and all the warnings heeded → 14.
- Use a workspace, working environment and tools purposely designed for electrostatically sensitive devices.

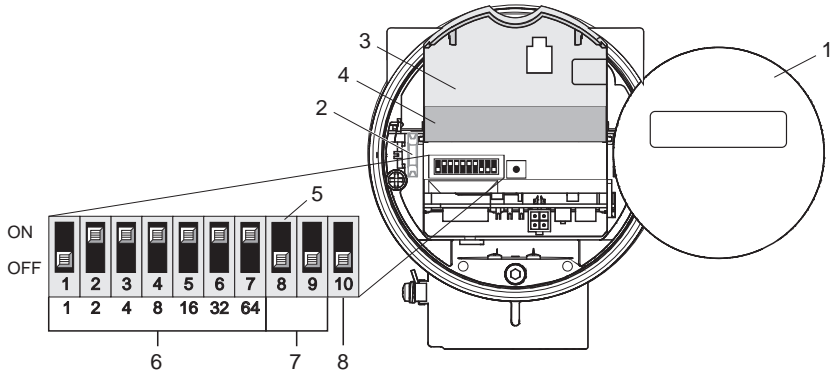

A0008755

- |   |  |
|---|--|
| <p>1 Local display module</p> <p>2 Retaining rails of local display module</p> <p>3 Plastic cover</p> <p>4 I/O board cover (COM module)</p> | <p>5 DIP switch:</p> <p>6 1 to 7 = device address (factory setting = 126)</p> <p>7 8 to 9 = not assigned</p> <p>8 10 = type of addressing</p> <p style="margin-left: 20px;">– ON = hardware addressing</p> <p style="margin-left: 20px;">– OFF = software addressing (factory setting)</p> |
|---|--|

- a. Switch off the power supply before opening the device.
- b. Unscrew cover of the electronics compartment from the transmitter housing.
- c. Remove the display module from the retaining rails and refit onto the right retaining rail with the left side (this secures the display module).
- d. Fold up the plastic cover.
- e. Fold up the cover of the I/O board (COM module).
- f. Configure the device address using DIP switches 1 to 7.
- g. Activate hardware addressing using DIP switch 10 (= ON).
- h. Installation is the reverse of the removal procedure.

## 5 Commissioning

### 5.1 Switching on the measuring device

On completion of the installation (successful post-installation check), wiring (successful post-connection check) and after making the necessary hardware settings, where applicable, the permitted power supply (see nameplate) can be switched on for the measuring device.

When the power supply is switched on, the measuring device performs a number of power-up checks and device self-checks. As this procedure progresses the following messages can appear on the onsite display:

Display examples:

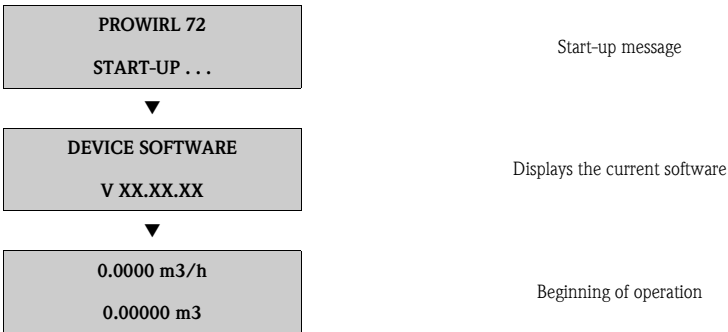

The measuring device starts operating as soon as the startup procedure is complete. Various measured values and/or status variables appear on the display.

 Note!

If an error occurs during startup, this is indicated by an error message. The error messages that occur most frequently when a measuring device is commissioned are described in the Troubleshooting section →  26.

## 5.2 Operation

### 5.2.1 Display elements

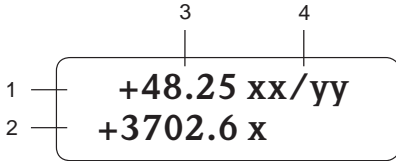

A0007557

- Display lines/fields
- Main line for primary measured values
- Additional line for additional measured variables/status variables
- Current measured values
- Engineering units/time units

### 5.2.2 Operating elements

Note!

The operating elements described here are only available for measuring devices with local operation. Measuring devices without local operation are operated via the fieldbus in question.

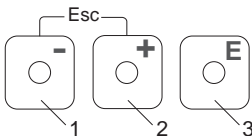

A0007559

- Operating keys
- (-) Minus key for entering, selecting
- (+) Plus key for entering, selecting
- Enter key for calling the function matrix, saving
- When the +/- keys are pressed simultaneously (Esc):
- Exit the function matrix step-by-step:
- > 3 sec. = cancel data input and return to the measured value display

### 5.2.3 Displaying error messages

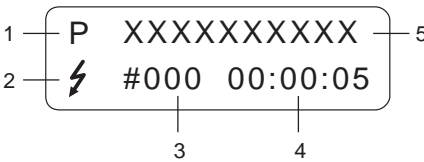

A0007561

- Type of error:
- P = Process error, S = System error
- Error message type:
- ⚡ = Fault message, ! = Notice message
- Error number
- Duration of the last error that occurred:
- Hours: Minutes: Seconds
- Error designation
- List of the most common error messages during commissioning → 26
- List of all error messages, see associated Operating Instructions on the CD-ROM

## 5.3 Navigating within the function matrix

Note!

The procedure described here only applies to measuring devices with local operation. Measuring devices without local operation are operated via the fieldbus in question.

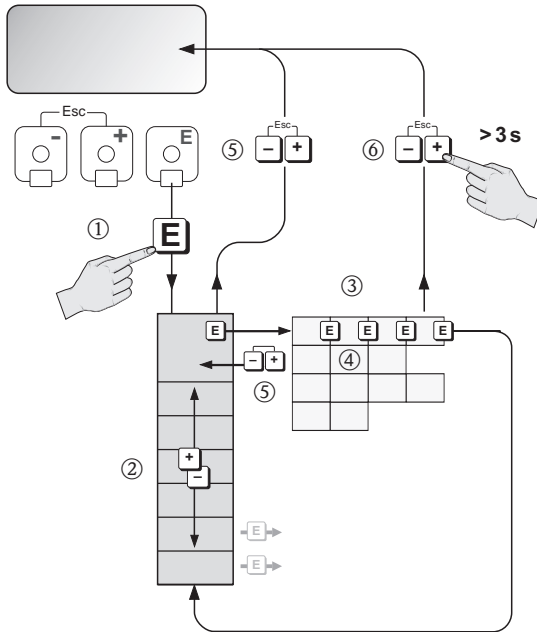

A0007562

- 1. → Enter the function matrix (starting with measured value display)
- 2. → Select the group (e.g. OPERATION)  
 → Confirm selection
- 3. → Select function (e.g. LANGUAGE)
- 4. → Enter code **72** (only for the first time you access the function matrix)  
 → Confirm entry
- 5. → Change function/selection (e.g. ENGLISH)  
 → Confirm selection
- 6. → Return to measured value display step by step
- 7. > 3 s → Return immediately to measured value display











## 5.4 Calling the Commissioning Quick Setup



Note!

The procedure described here only applies to measuring devices with HART communication. Measuring devices with PROFIBUS PA and FOUNDATION Fieldbus communication do not have a Commissioning Quick Setup.

All the functions needed for commissioning are called up automatically with the Quick Setup. The functions can be changed and adapted to the process in question.

1.  → Enter the function matrix (starting with measured value display)
2.  → Select the group QUICK SETUP
  -  → Confirm selection
3. QUICK SETUP COMMISSIONING function appears.
4. Intermediate step if configuration is blocked:
  -  → Enter the code **72** (confirm with 10) and thus enable configuration
5.  → Go to Commissioning Quick Setup
6.  → Select YES
  -  → Confirm selection
7.  → Start Commissioning Quick Setup
8. Configure the individual functions/settings:
  - Via -key, select option or enter number
  - Via -key, confirm entry and go to next function
  - Via -key, return to Setup Commissioning function (settings already made are retained)

All the available functions of the measuring device and their configuration options as well as additional Quick Setups, if available, are described in detail in the Operating Instructions. The related Operating Instructions can be found on the CD-ROM.

The measuring device is ready for operation on completion of the Quick Setup.



### 5.4.1 Flowchart of "Commissioning" Quick Setup

The display returns to the QUICK SETUP COMMISSIONING cell if you press the ESC key combination 10 during interrogation.

#### Options language, application and measuring variable

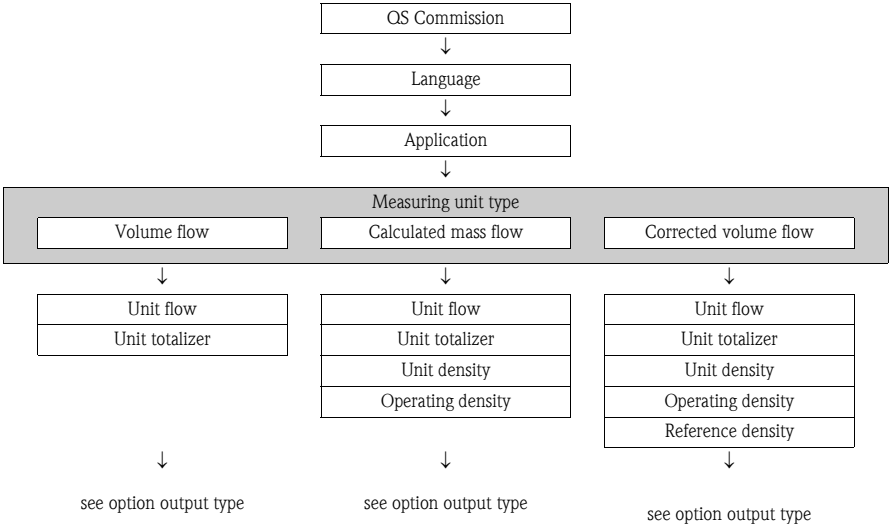

#### Option output type

Only the output (current output or pulse/status output) not yet configured in the current Quick Setup is offered for selection after the first cycle.

The "YES" option appears as long as a free output is still available. "NO" is the only option displayed when no further outputs are available.

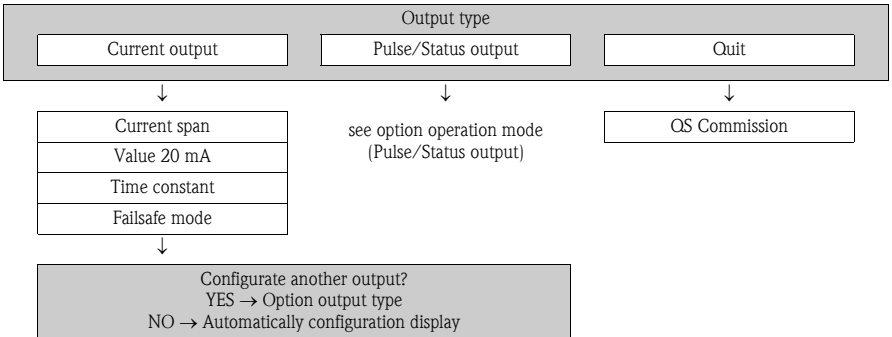

## Option operation mode (Pulse-/Status output)

The "YES" option appears as long as a free output is still available. "NO" is the only option displayed when no further outputs are available.

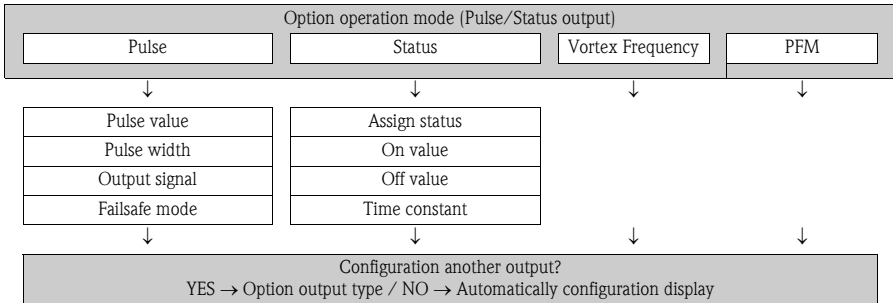

## Automatically configuration display

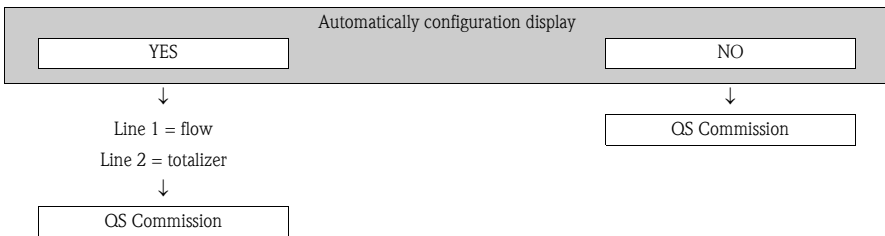

## 5.5 Software settings

### 5.5.1 Device address

Has to be set for measuring devices with the following communication methods:

- PROFIBUS PA: Device address range: 0 to 126, factory setting 126

The device address can be configured via:

- Miniature switches → see **Hardware settings** → 19
- Device functions/Operating program FieldCare → see Operating Instructions on the CD-ROM

## 5.6 Troubleshooting

A complete description of all the error messages is provided in the Operating Instructions on the CD-ROM.



Note!

The output signals (e.g. pulse, frequency) of the measuring device must correspond to the higher-order controller.



[www.endress.com/worldwide](http://www.endress.com/worldwide)

---

**Endress+Hauser**   
People for Process Automation

---

KA00030D/06/EN/14.11  
71154534  
FM+SGML 9.0