



Level



Pressure



Flow



Temperature



Liquid
Analysis



Registration



Systems
Components



Services



Solutions

Brief Operating Instructions

Proline Promag 23

Electromagnetic Flow Measuring System in Two-wire Technology

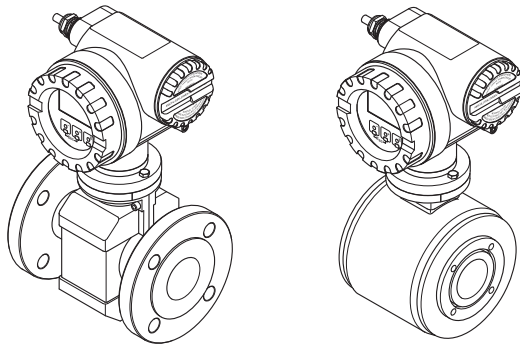

These Brief Operating Instructions are **not** intended to replace the Operating Instructions provided in the scope of supply. Detailed information is provided in the Operating Instructions and the additional documentation on the CD-ROM supplied.

The complete device documentation consists of:

- These Brief Operating Instructions
- Depending on the device version:
 - Operating Instructions and the Description of Device Functions
 - Approvals and safety certificates
 - Special safety instructions in accordance with the approvals for the device (e.g. explosion protection, pressure equipment directive etc.)
 - Additional device-specific information

Table of contents

1	Safety instructions	3
1.1	Designated use	3
1.2	Installation, commissioning and operation	3
1.3	Operational safety	3
1.4	Safety conventions	5
2	Installation	6
2.1	Transporting to the measuring point	6
2.2	Installation conditions	7
2.3	Installing the Promag P sensor	11
2.4	Promag P tightening torques	12
2.5	Installing the Promag H sensor	14
2.6	Installing the transmitter housing	16
2.7	Post-installation check	17
3	Wiring	18
3.1	Connecting the various housing types	18
3.2	Potential equalization	19
3.3	Degree of protection	20
3.4	Post-connection check	20
4	Commissioning	21
4.1	Switching on the measuring device	21
4.2	Operation	22
4.3	Navigating within the function matrix	23
4.4	Troubleshooting	24

1 Safety instructions

1.1 Designated use

- The measuring device is to be used only for measuring the flow of conductive liquids in closed pipes. Liquids can be measured as of a minimum conductivity of 50 $\mu\text{S}/\text{cm}$.
- Any use other than that described here compromises the safety of persons and the entire measuring system and is, therefore, not permitted.
- The manufacturer is not liable for damage caused by improper or non-designated use.

1.2 Installation, commissioning and operation

- The measuring device must only be installed, connected, commissioned and maintained by qualified and authorized specialists (e.g. electrical technicians) in full compliance with the instructions in these Brief Operating Instructions, the applicable norms, legal regulations and certificates (depending on the application).
- The specialists must have read and understood these Brief Operating Instructions and must follow the instructions they contain. If you are unclear on anything in these Brief Operating Instructions, you must read the Operating Instructions (on the CD-ROM). The Operating Instructions provide detailed information on the measuring device.
- The measuring device may only be modified if such work is expressly permitted in the Operating Instructions (on the CD-ROM).
- Repairs may only be performed if a genuine spare parts kit is available and this repair work is expressly permitted.
- The measuring device should only be installed in a de-energized state free from outside loads or strain.
- If performing welding work on the piping, the welding unit may not be grounded by means of the measuring device.



1.3 Operational safety

- The measuring device is designed to meet state-of-the-art safety requirements, has been tested, and left the factory in a condition in which it is safe to operate. Relevant regulations and European standards have been observed.
- The manufacturer reserves the right to modify technical data without prior notice. Your Endress+Hauser distributor will supply you with current information and updates to these Operating Instructions.
- The information on the warning notices, nameplates and connection diagrams affixed to the device must be observed. These contain important data on the permitted operating conditions, the range of application of the device and information on the materials used.
- If the device is not used at atmospheric temperatures, compliance with the relevant marginal conditions as specified in the device documentation supplied (on CD-ROM) is mandatory.
- The device must be wired as specified in the wiring and connection diagrams. Interconnection must be permitted.
- All parts of the device must be included in the potential equalization of the system.

- Cables, certified cable glands and certified dummy plugs must be suitable to withstand the prevailing operating conditions, such as the temperature range of the process. Housing apertures that are not used must be sealed with dummy plugs.
- The device should only be used for fluids to which all the wetted parts of the device are sufficiently resistant. With regard to special fluids, including fluids used for cleaning, Endress+Hauser will be happy to assist in clarifying the corrosion-resistant properties of wetted materials.

However, minor changes in temperature, concentration or in the degree of contamination in the process may result in variations in corrosion resistance.

For this reason, Endress+Hauser does not accept any responsibility with regard to the corrosion resistance of wetted materials in a specific application. The user is responsible for the choice of suitable wetted materials in the process.

- When hot fluid passes through the measuring tube, the surface temperature of the housing increases. In the case of the sensor, in particular, users should expect temperatures that can be close to the fluid temperature. If the temperature of the fluid is high, implement sufficient measures to prevent burning or scalding.
- Hazardous areas
Measuring devices for use in hazardous areas are labeled accordingly on the nameplate. Relevant national regulations must be observed when operating the device in hazardous areas. The Ex documentation on the CD-ROM is an integral part of the entire device documentation. The installation regulations, connection data and safety instructions provided in the Ex documentation must be observed. The symbol and name on the front page provides information on the approval and certification (e.g.  Europe,  USA,  Canada). The nameplate also bears the documentation number of this Ex documentation (XA*****D/./..)
- Hygienic applications
Measuring devices for hygienic applications have their own special labeling. Relevant national regulations must be observed when using these devices.
- Pressure instruments
Measuring devices for use in systems that need to be monitored are labeled accordingly on the nameplate. Relevant national regulations must be observed when using these devices. The documentation on the CD-ROM for pressure instruments in systems that need to be monitored is an integral part of the entire device documentation. The installation regulations, connection data and safety instructions provided in the Ex documentation must be observed.
- Endress+Hauser will be happy to assist in clarifying any questions on approvals, their application and implementation.

1.4 Safety conventions



Warning!

"Warning" indicates an action or procedure which, if not performed correctly, can result in injury or a safety hazard. Comply strictly with the instructions and proceed with care.



Caution!

"Caution" indicates an action or procedure which, if not performed correctly, can result in incorrect operation or destruction of the device. Comply strictly with the instructions.



Note!

"Note" indicates an action or procedure which, if not performed correctly, can have an indirect effect on operation or trigger an unexpected response on the part of the device.

2 Installation

2.1 Transporting to the measuring point

- Transport the measuring device to the measuring point in the original packaging.
- Do not remove the covers or caps until immediately before installation.

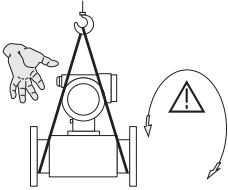

A0013285

To transport the unit, use slings slung around the process connections or use lugs (if available).

Warning!
Risk of injury! The device can slip.
The center of gravity of the measuring device may be higher than the holding points of the slings.
Always ensure that the device cannot slip or turn around its axis.

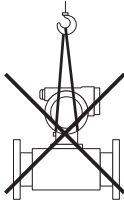

A0013286

Do not lift the devices by their transmitter housing. Do not use chains as they could damage the housing.

2.2 Installation conditions

2.2.1 Dimensions

For the dimensions of the measuring device, see the associated Technical Information on the CD-ROM.

2.2.2 Mounting location

The accumulation of air or formation of gas bubbles in the measuring tube can result in an increase in measuring errors.

For this reason avoid the following mounting locations in the pipe:

- At the highest point of a pipeline. Risk of air accumulating!
- Directly upstream from a free pipe outlet in a down pipe.

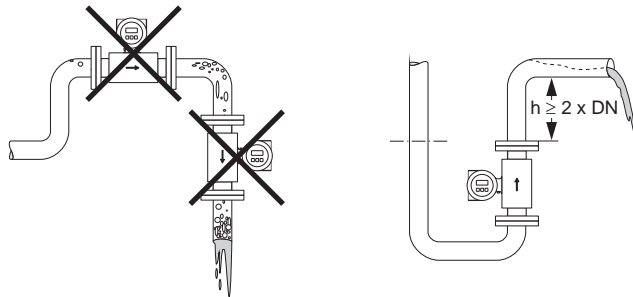

A0008154

Installation of pumps

Do not install the sensor on the intake side of a pump. This precaution is to avoid low pressure and the consequent risk of damage to the lining of the measuring tube. It might be necessary to use pulse dampers in systems incorporating piston pumps, piston diaphragm pumps or peristaltic pumps.

Information on the measuring system's pressure tightness and resistance to vibration and shock can be found in the Operating Instructions of the CD-ROM.

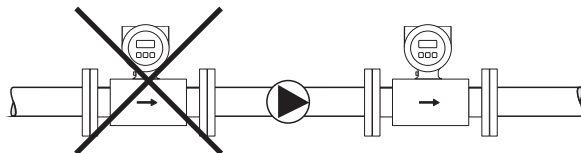

A0003203

Partially filled pipes

Partially filled pipes with gradients necessitate a drain-type configuration.

The empty pipe detection (EPD) function offers additional protection by detecting empty or partially filled pipes.

- ☞ **Caution!**
Risk of solids accumulating! Do not install the sensor at the lowest point in the drain. It is advisable to install a cleaning valve.

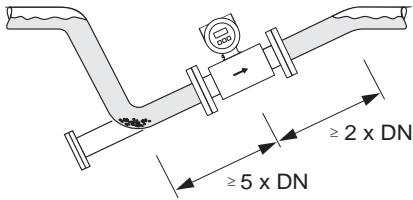

Installation in a partially filled pipe

A0008155

Down pipes

Install a siphon or a vent valve downstream of the sensor in down pipes longer than 5 meters (16 ft). This precaution is to avoid low pressure and the consequent risk of damage to the lining of the measuring tube. This measure also prevents the system losing prime, which could cause air pockets.

For information on the pressure tightness of the measuring tube lining, see the Operating Instructions on the CD-ROM.

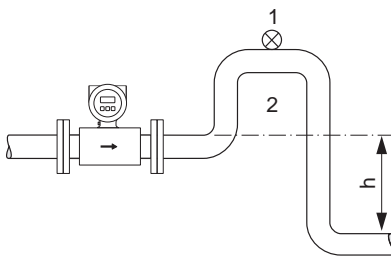

Measures for installation in a down pipe [h > 5 m (16 ft)]

1. Vent valve
2. Siphon

A0008157

2.2.3 Orientation

An optimum orientation helps avoid gas and air accumulations and buildup in the measuring tube. The measuring device, nevertheless, supplies a range of functions and tools to measure problematic fluids correctly:

- Electrode cleaning circuitry (ECC) to prevent electrically conductive deposits in the measuring tube, e.g. for fluids causing buildup
- Empty pipe detection (EPD) for detecting partially filled measuring tubes, e.g. in the case of degassing fluids or varying process pressures

Vertical orientation

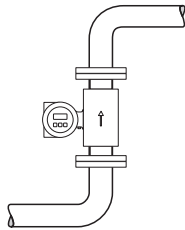

This orientation is optimum for self-emptying piping systems and when using empty pipe detection (EPD) or open electrode detection (OED).

A0008158

Horizontal orientation

The measuring electrode plane should be horizontal. This prevents brief insulation of the two electrodes by entrained air bubbles.

 Caution!

In the case of horizontal orientation, empty pipe detection only works correctly if the transmitter housing is facing upwards. Otherwise there is no guarantee that empty pipe detection will respond if the measuring tube is only partially filled or empty.

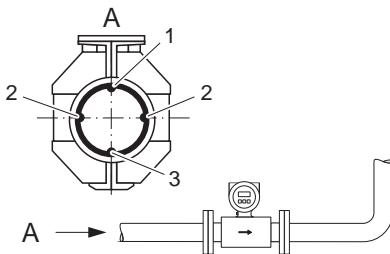

1. EPD electrode for empty pipe detection (not for Promag H)
2. Measuring electrodes for signal detection
3. Reference electrode for potential equalization (not for Promag H)

A0008159

Inlet and outlet runs

If possible, install the sensor upstream from fittings such as valves, T-pieces, elbows, etc.

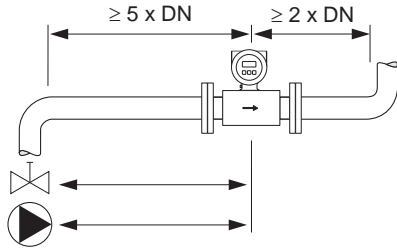

A0008160

The following inlet and outlet runs must be observed in order to meet accuracy specifications:

- Inlet run: $\geq 5 \times DN$
- Outlet run: $\geq 2 \times DN$

2.2.4 Vibrations

Secure and fix both the piping and the sensor if vibrations are severe.

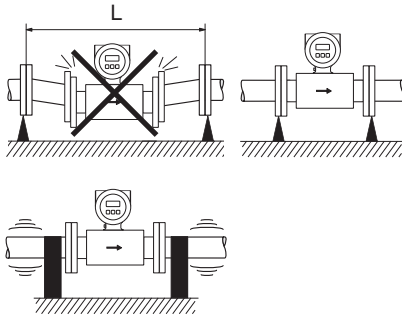

A0008161

Measures to prevent device vibration
[$L > 10 \text{ m (33 ft)}$]

2.3 Installing the Promag P sensor

⚠ Caution!

- The plates mounted on the two sensor flanges protect the PTFE which is turned over the flanges and, consequently, should not be removed until immediately prior to mounting the sensor.
- The protective plates must always remain mounted while the device is in storage.
- Make sure that the lining at the flange is not damaged or removed.

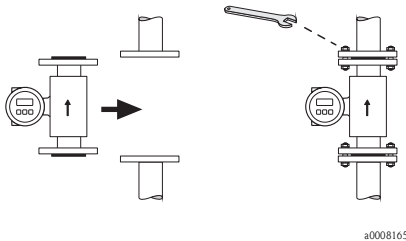

✎ Note!

Screws, nuts, seals, etc. are not included in the scope of supply and must be supplied by the customer.

The sensor is installed between the two pipe flanges:

- The requisite torques must be observed → 12
- If grounding disks are used, follow the mounting instructions which will be enclosed with the shipment.

2.3.1 Seals

Comply with the following instructions when installing seals:

- **No** seals are required for PFA or PFTE measuring tube lining.
- For DIN flanges, only use seals to DIN EN 1514-1.
- Make sure that the mounted seals do not protrude into the piping cross-section.

⚠ Caution!

Risk of short circuit! Do not use electrically conductive sealing compounds such as graphite! An electrically conductive layer could form on the inside of the measuring tube and short-circuit the measuring signal.

2.3.2 Ground cable

If necessary, special ground cables can be ordered as accessories for potential equalization.

2.4 Promag P tightening torques

- The tightening torques listed below are for lubricated threads only.
- Always tighten the screws uniformly and in diagonally opposite sequence.
- Overtightening the screws will deform the sealing faces or damage the seals.
- The values listed below apply only to pipes not subjected to tensile stress.

2.4.1 Tightening torques for pressure ratings in accordance with EN (DIN)

Nominal diameter [mm]	Pressure rating [bar]	Screws	Max. tightening torque [Nm]	
			PTFE	PFA
25	PN 40	4 × M 12	26	20
32	PN 40	4 × M 16	41	35
40	PN 40	4 × M 16	52	47
50	PN 10	4 × M 16	–	–
	PN 16	4 × M 16	–	–
	PN 40	4 × M 16	65	59
65 *	PN 10	8 × M 16	–	–
	PN 16	8 × M 16	43	40
65	PN 40	8 × M 16	43	40
80	PN 10	8 × M 16	–	–
	PN 16	8 × M 16	53	48
	PN 40	8 × M 16	53	48
100	PN 10	8 × M 16	–	–
	PN 16	8 × M 16	57	51
	PN 40	8 × M 20	78	70
125	PN 10	8 × M 16	–	–
	PN 16	8 × M 16	75	67
	PN 40	8 × M 24	111	99
150	PN 10	8 × M 20	–	–
	PN 16	8 × M 20	99	85
	PN 40	8 × M 24	136	120
200	PN 10	8 × M 20	141	101
	PN 16	12 × M 20	94	67
	PN 25	12 × M 24	138	105

* Designed acc. to EN 1092-1 (not to DIN 2501)

2.4.2 Tightening torques for pressure ratings in accordance with JIS

Nominal diameter [mm]	Pressure rating [bar]	Screws	Max. tightening torque [Nm]	
			PTFE	PFA
25	10K	4 × M 16	32	32
	20K	4 × M 16	32	32
32	10K	4 × M 16	38	38
	20K	4 × M 16	38	38
40	10K	4 × M 16	41	41
	20K	4 × M 16	41	41
50	10K	4 × M 16	54	54
	20K	8 × M 16	27	27
65	10K	4 × M 16	74	74
	20K	8 × M 16	37	37
80	10K	8 × M 16	38	38
	20K	8 × M 20	57	57
100	10K	8 × M 16	47	47
	20K	8 × M 20	75	75
125	10K	8 × M 20	80	80
	20K	8 × M 22	121	121
150	10K	8 × M 20	99	99
	20K	12 × M 22	108	108
200	10K	12 × M 20	82	82
	20K	12 × M 22	121	121

2.4.3 Tightening torques for pressure ratings in accordance with ANSI

Nominal diameter [mm]	Pressure rating [bar]	Screws	Max. tightening torque [Nm]	
			PTFE	PFA
1"	Class 150	4 × ½"	8.1	7.4
	Class 300	4 × 5/8"	10	8.9
1½"	Class 150	4 × ½"	18	15
	Class 300	4 × ¾"	25	23
2"	Class 150	4 × 5/8"	35	32
	Class 300	8 × 5/8"	17	16
3"	Class 150	4 × 5/8"	58	49
	Class 300	8 × ¾"	35	31
4"	Class 150	8 × 5/8"	41	37
	Class 300	8 × ¾"	49	44
6"	Class 150	8 × ¾"	78	63
	Class 300	12 × ¾"	54	49
8"	Class 150	8 × ¾"	105	80

2.5 Installing the Promag H sensor

2.5.1 Seals

When mounting the process connections, make sure that the seals in question are free from dirt and centered correctly.

Caution!

- The screws must be securely tightened in the case of metal process connections. Together with the sensor, the process connection forms a metal connection that ensures defined seal compression.
- With regard to process connections made of plastic material, comply with the max. torques for lubricated threads (7 Nm / 5.2 lbf ft). A seal must always be used between the connection and counterflange for plastic flanges.
- The seals should be replaced periodically depending on the application, particularly if molded seals are used (aseptic version)! The intervals between seal replacement depend on the frequency of the cleaning cycles and the fluid and cleaning temperatures. Replacement seals can be ordered as an accessory.

2.5.2 Usage and assembly of ground rings (DN 2 to 25 / 1/12 to 1")

In the case of process connections made of plastic (e.g. flange connections or adhesive couplings), potential equalization between the sensor and fluid must be ensured via additional grounding rings.

If grounding rings are missing, this can affect accuracy or result in the destruction of the sensor due to electrochemical electrode reduction.

Caution!

- Depending on the order option, appropriate plastic disks are used instead of grounding rings for the process connections. These plastic disks only act as a kind of "place holder" and do not have any potential equalization function whatsoever. In addition, they also assume an important sealing function at the sensor/connection interface. Thus, these plastic disks/seals should never be removed and should always be mounted for process connections without metal grounding rings!
- Grounding rings can be ordered separately from Endress+Hauser as an accessory. When ordering, make sure that the grounding rings are compatible with the electrode material. Otherwise there is the risk that electrodes can be damaged by electrochemical corrosion! For information on materials, see the Operating Instructions on the CD-ROM.
- Grounding rings, incl. seals, are mounted inside the process connections. The face-to-face length is not affected.

Installing the grounding rings

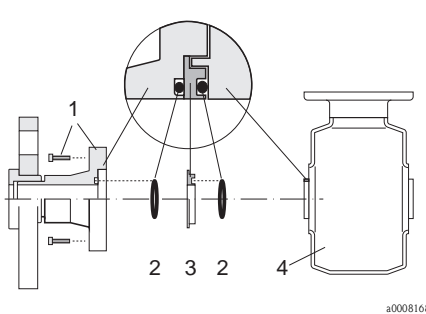

- 1 = Process connection hexagonal-headed bolts
- 2 = O-ring seals
- 3 = Grounding ring or plastic disk (place holder)
- 4 = Sensor

- a. Release the 4 hexagonal-headed bolts (1) and remove the process connection from the sensor (4).
- b. Remove the plastic disk (3) including the two O-ring seals (2) from the process connection.
- c. Insert one of the O-ring seals (2) back into the groove of the process connection.
- d. Place the metal grounding ring (3) into the process connection as illustrated.
- e. Now insert the second O-ring seal (2) into the groove of the grounding ring.
- f. Mount the process connection back onto the sensor. In doing so, make sure to observe the max. torques for lubricated threads (7 Nm / 5.2 lbf ft).

2.5.3 Welding the transmitter into the pipe (weld nipple)



Caution!

Risk of destroying the electronics! Make sure that the welding system is not grounded via the sensor or transmitter.

- a. Secure the sensor with a few welding points in the pipe.
A welding jig suitable for this purpose can be ordered separately as an accessory.
- b. Release the screws on the process connection flange and remove the sensor, including the seal, from the pipe.
- c. Weld the process connection into the pipe.
- d. Mount the sensor back into the pipe.
In doing so, make sure the seals are clean and correctly positioned.



Note!

- When welding is performed correctly with thin-walled pipes carrying food, the seal is not damaged by the heat even when it is mounted. It is recommended, however, to disassemble the sensor and seal.
- For the disassembly work, it must be possible to open the pipe approx. 8 mm (0.31 in) in total.

2.6 Installing the transmitter housing

2.6.1 Turning the transmitter housing

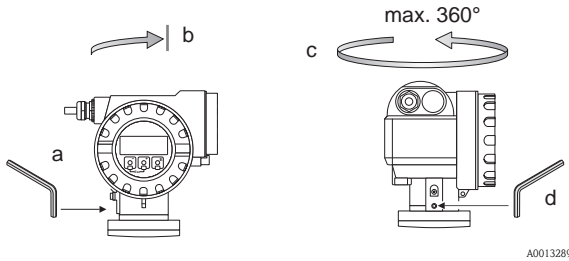

- Release the setscrew.
- Turn the transmitter housing gently clockwise until the stop (end of the thread).
- Turn the transmitter counterclockwise (max. 360°) to the desired position.
- Retighten the setscrew.

A0013289

2.6.2 Turning the onsite display

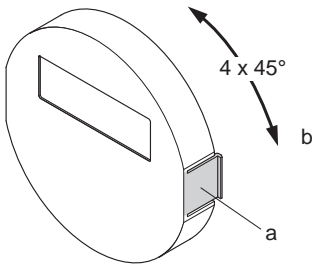

- Press in the side latches on the display module and remove the module from the cover plate of the electronics compartment.
- Turn the display to the desired position (max. $4 \times 45^\circ$ in both directions) and reset it onto the cover plate of the electronics compartment.

A0007541

2.7 Post-installation check

- Is the measuring device damaged (visual inspection)?
- Does the device correspond to specifications at the measuring point, including process temperature and pressure, ambient temperature, minimum fluid conductivity, measuring range, etc.?
- Does the arrow on the sensor nameplate match the actual direction of flow through the pipe?
- Is the position of the measuring electrode plane correct?
- Is the position of the empty pipe detection electrode correct?
- Were all screws tightened to the specified torques when the sensor was installed?
- Were the correct seals used (type, material, installation)?
- Are the measuring point number and labeling correct (visual inspection)?
- Were the inlet and outlet runs respected?
 - Inlet run $\geq 5 \times \text{DN}$
 - Outlet run $\geq 2 \times \text{DN}$
- Is the measuring device protected against moisture and direct sunlight?
- Is the sensor adequately protected against vibration (attachment, support)?
Acceleration up to 2 g by analogy with IEC 600 68-2-8

3 Wiring

⚠ Warning!

Risk of electric shock! Components carry dangerous voltages.

- Never mount or wire the measuring device while it is connected to the power supply.
- Before connecting the power supply, check the safety equipment.
- Route the power supply and signal cables so they are securely seated.
- Seal the cable entries and covers tight.

☞ Caution!

Risk of damaging the electronic components!

- Connect the power supply in accordance with the connection data on the nameplate.
- Connect the signal cable in accordance with the connection data in the Operating Instructions or the Ex documentation on the CD-ROM.

In addition, for Ex-certified measuring devices

⚠ Warning!

When wiring Ex-certified measuring devices, all the safety instructions, wiring diagrams, technical information etc. of the related Ex documentation must be observed
→ Ex documentation on the CD-ROM.

3.1 Connecting the various housing types

Wire the unit using the terminal assignment diagram inside the cover.

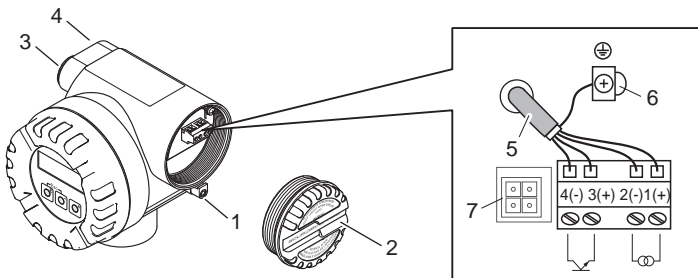

- 1 Securing clamp for connection compartment cover
- 2 Connection compartment cover
- 3 Cable gland for connecting cable
- 4 Cable gland for optional output with HART version
- 5 Shielded signal cable:
 - Terminal No. 1(+)/ 2(-): Transmitter power supply/current output
 - Terminal No. 3(+)/ 4(-): Pulse/frequency output
- 6 Ground terminal for signal cable
- 7 Service connector

A0013293

3.2 Potential equalization

Perfect measurement is only ensured when the medium and the sensor have the same electrical potential. Most sensors have a reference electrode installed as standard, which guarantees the required potential connection. This usually means that the use of ground disks or other measures are unnecessary.

- Promag P
 - Reference electrode available as standard with electrode material: SS 316L, Alloy C-22 and tantalum
 - Reference electrode is optionally available for electrode material: Pt/Rh
- Promag H
 - No reference electrode available. There is always an electrical connection to the fluid via the metal process connection.
 - In the case of plastic process connections, potential equalization must be ensured through the use of grounding rings.



Note!

For installation in metal pipes, it is advisable to connect the ground terminal of the transmitter housing to the piping. Observe in particular the in-house grounding guidelines as well.

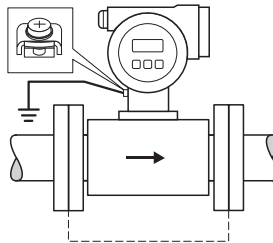

A0013253



Caution!

For sensors without reference electrodes or without metal process connections, carry out potential equalization as described in the Operating Instructions (see the CD) for special cases. These special measures are particularly important when standard grounding measures cannot be applied or extremely strong equalizing currents are expected.

3.3 Degree of protection

The devices meet all the requirements for IP 67.

After mounting in the field or service work, the following points have to be observed to ensure that IP 67 protection is retained:

- Install the measuring device in such a way that the cable entries do not point upwards.
- Do not remove the seal from the cable entry.
- Remove all unused cable entries and plug them with suitable drain plugs.

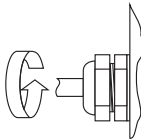

Tighten the cable entries correctly.

A0007549

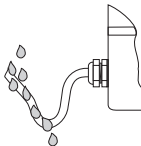

The cables must loop down before they enter the cable entries ("water trap").

A0007550

3.4 Post-connection check

- Are cables or the device damaged (visual inspection)?
- Does the supply voltage match the information on the nameplate?
- Do the cables used comply with the necessary specifications?
- Do the mounted cables have adequate strain relief and are they routed securely?
- Is the cable type route completely isolated? Without loops and crossovers?
- Are all screw terminals firmly tightened?
- Have all the measures for grounding and potential equalization been correctly implemented?
- Are all cable entries installed, firmly tightened and correctly sealed?
- Cable routed as a "water trap" in loops?
- Are all the housing covers installed and securely tightened?

In addition, for measuring devices with fieldbus communication

- Are all the connecting components (T-boxes, junction boxes, connectors, etc.) connected with each other correctly?
- Has each fieldbus segment been terminated at both ends with a bus terminator?
- Has the max. length of the fieldbus cable been observed in accordance with the specifications?
- Has the max. length of the spurs been observed in accordance with the specifications?
- Is the fieldbus cable fully shielded and correctly grounded?

4 Commissioning

4.1 Switching on the measuring device

On completion of the installation (successful post-installation check), wiring (successful post-connection check) and after making the necessary hardware settings, where applicable, the permitted power supply (see nameplate) can be switched on for the measuring device.

When the power supply is switched on, the measuring device performs a number of power-up checks and device self-checks. As this procedure progresses the following messages can appear on the onsite display:

Display examples:

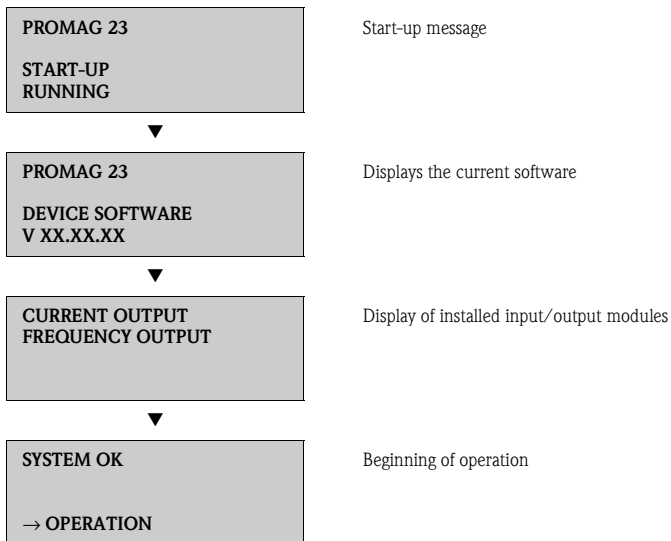

The measuring device starts operating as soon as the startup procedure is complete. Various measured values and/or status variables appear on the display.



Note!

If an error occurs during startup, this is indicated by an error message.

The error messages that occur most frequently when a measuring device is commissioned are described in the Troubleshooting section → [24](#).

4.2 Operation

4.2.1 Display elements

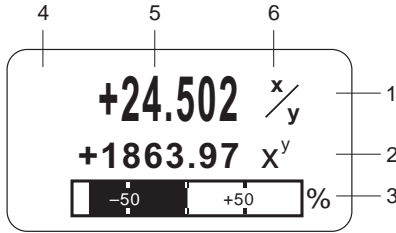

A0013298

Display lines/fields

1. Main line for primary measured values
2. Additional line for additional measured variables/status variables
3. Information line, e.g. for bar graph display
4. Info icons, e.g. volume flow
5. Current measured values
6. Engineering units/time units

4.2.2 Operating elements

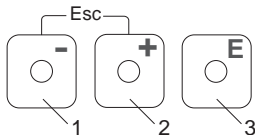

A0007559

Operating keys

1. (-) Minus key for entering, selecting
2. (+) Plus key for entering, selecting
3. Enter key for calling the function matrix, saving

When the +/- keys are pressed simultaneously (Esc):

- Exit the function matrix step-by-step:
- > 3 sec. = cancel data input and return to the measured value display

4.2.3 Displaying error messages

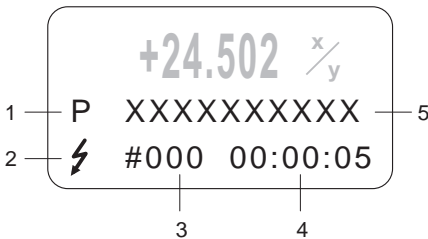

A0013300

1. Type of error:
P = Process error, S = System error
2. Error message type:
f = Fault message, ! = Notice message
3. Error number
4. Duration of the last error that occurred:
Hours: Minutes: Seconds
5. Error designation

List of all error messages, see associated Operating Instructions on the CD-ROM

4.3 Navigating within the function matrix

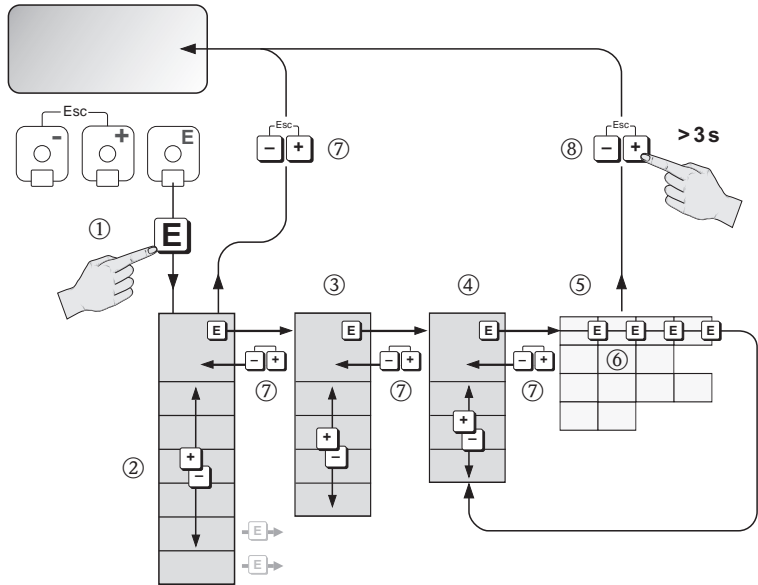

A0007665

1. → Enter the function matrix (starting with measured value display)
2. → Select the Block (e.g. USER INTERFACE)
 → Confirm selection
3. → Select the group (e.g. CONTROL)
 → Confirm selection
4. → Select the function group (e.g. BASIC CONFIGURATION)
 → Confirm selection
5. → Select function (e.g. LANGUAGE)
6. → Enter code **23** (only for the first time you access the function matrix)
 → Confirm entry

 → Change function/selection (e.g. ENGLISH)
 → Confirm selection
7. → Return to measured value display step by step
8. > 3 s → Return immediately to measured value display

4.4 Troubleshooting

A complete description of all the error messages is provided in the Operating Instructions on the CD-ROM.



Note!

The output signals (e.g. pulse, frequency) of the measuring device must correspond to the higher-order controller.

www.endress.com/worldwide

Endress+Hauser 
People for Process Automation