



Level



Pressure



Flow



Temperature



Liquid  
Analysis



Registration



Systems  
Components



Services



Solutions

## Operating Instructions

# Temperature Converter RCV-NMT NCT530

## NCT530-7 External type

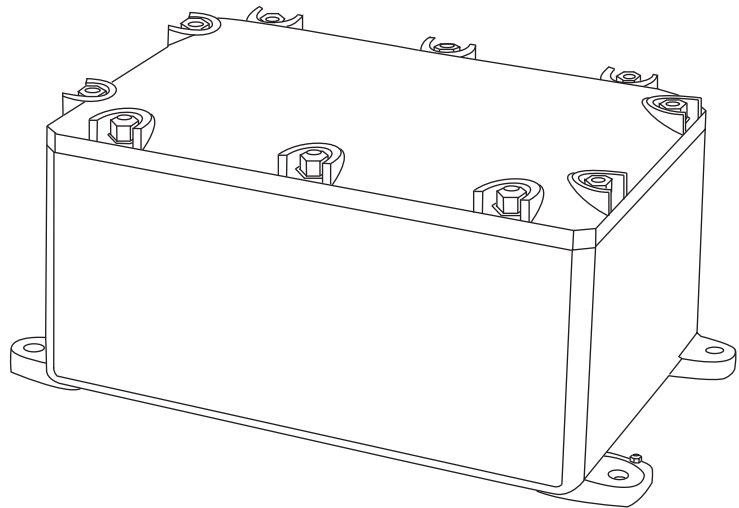

# Table of contents

<b>1</b>	<b>Safety instructions</b> .....	<b>3</b>	<b>4</b>	<b>Wiring</b> .....	<b>12</b>
1.1	Designated use .....	3	4.1	Installation procedure .....	12
1.2	Installation, commissioning and operation .....	3			
1.3	Product Requirements .....	3	<b>5</b>	<b>Troubleshooting</b> .....	<b>13</b>
1.4	Safety of operation .....	3	5.1	Spare parts .....	13
1.5	Notes on safety conventions and symbols .....	4	5.2	System error messages .....	14
			5.3	Return .....	14
<b>2</b>	<b>Identification</b> .....	<b>5</b>	5.4	Disposal .....	15
2.1	Device designation .....	5	5.5	Contact addresses of Endress+Hauser .....	15
2.2	Scope of delivery .....	7			
2.3	Registered trademarks .....	7	<b>6</b>	<b>Technical data</b> .....	<b>16</b>
<b>3</b>	<b>Installation</b> .....	<b>8</b>			
3.1	Incoming acceptance, transport, storage .....	8			
3.2	Installation conditions .....	9			

# 1 Safety instructions

## 1.1 Designated use

NCT530 is useful when the existing transmitter is upgraded to a HART<sup>®</sup> input device, but the RTD average temperature sensor continues in place. For example, TGM4000 is upgrade to NMS5 Proservo, but the existing RCV12 cannot be replaced because the tank is in operation. In this case, NCT530 provides signal conversion, from RTD out put of RCV12 to HART<sup>®</sup> input for NMS5 Proservo.

## 1.2 Installation, commissioning and operation

- Mounting, electrical installation, start-up and maintenance of the instrument may only be carried out by trained personnel authorized by the operator of the facility.
- Personnel must absolutely and without fail read and understand this Operating instruction before carrying out its instructions.
- The instrument may only be operated by personnel who are authorized and trained by the operator of the facility. All instructions in this manual are to be observed without fail.
- The installer must make sure that the measuring system is correctly wired according to the wiring diagrams. The measuring system is to be grounded.

## 1.3 Product Requirements

### Power Supply

Please check specifications of NCT such as power and frequency before turning on the power. Please use voltage suitable for NCT operating.

### Power Cable

Please use the power cable specified by our company and make sure to ground.

### Ground

Please do not remove earth terminal and earth wire when the power is on.

### Connection to the peripheral equipment

It is possible to connect to the peripheral equipment explained in this Operating instruction. Please refer to each Operating instruction when connecting.

## 1.4 Safety of operation

### Hazardous areas

Measuring systems for use in hazardous environments are accompanied by separate "Ex documentation", which is an integral part of this Operating Manual. Strict compliance with the installation instructions and ratings as stated in this supplementary documentation is mandatory.

- Ensure that all personnel are suitably qualified.
- Observe the specifications in the certificate as pipe as national and local regulations.

### FCC approval

This device complies with part 15 of the FCC Rules. Operation is subject to the following two conditions: (1) This device may not cause harmful interference, and (2) this device must accept any interference received, including interference that may cause undesired operation.

### Caution!





Changes or modifications not expressly approved by the party responsible for compliance could void the user's authority to operate the equipment.

## 1.5 Notes on safety conventions and symbols

In order to highlight safety-relevant or alternative operating procedures in the manual, the following conventions have been used, each indicated by a corresponding symbol in the margin.





### Safety conventions

Symbol	Meaning
	<b>Warning!</b> A warning highlights actions or procedures which, if not performed correctly, will lead to personal injury, a safety hazard or destruction of the instrument.
	<b>Caution!</b> Caution highlights actions or procedures which, if not performed correctly, may lead to personal injury or incorrect functioning of the instruments.
	<b>Note!</b> A note highlights actions or procedures which, if not performed correctly, may indirectly affect operation or may lead to an instrument response which is not planned.

### Explosion protection

	<b>Device certified for use in explosion hazardous area</b> If the device has this symbol embossed on its name plate it can be installed in an explosion hazardous area.
	<b>Explosion hazardous area</b> Symbol used in drawings to indicate explosion hazardous area. - Devices located in and wiring entering areas with the designation "explosion hazardous areas" must conform with the stated type of protection.
	<b>Safe area (non-explosion hazardous area)</b> Symbol used in drawings to indicate, if necessary, non-explosion hazardous areas. - Devices located in safe areas still require a certificate if their outputs run into explosion hazardous areas.

### Electrical Symbols

	<b>Direct voltage</b> A terminal to which or from which a direct current or voltage may be applied or supplied
	<b>Alternating voltage</b> A terminal to which or from which an alternating (sine-wave) current or voltage may be applied or supplied
	<b>Grounded terminal</b> A grounded terminal, which as far as the operator is concerned, is already grounded by means of an earth grounding system.
	<b>Protective grounded (earth) terminal</b> A terminal which must be connected to earth ground prior to making any other connection to the equipment.
	<b>Equipotential connection (earth bonding)</b> A connection made to the plant grounding system which may be of type e.g. neutral star or equipotential line according to national or company practice

## 2 Identification

### 2.1 Device designation

#### 2.1.1 Nameplate

The following technical data are given on the instrument nameplate:

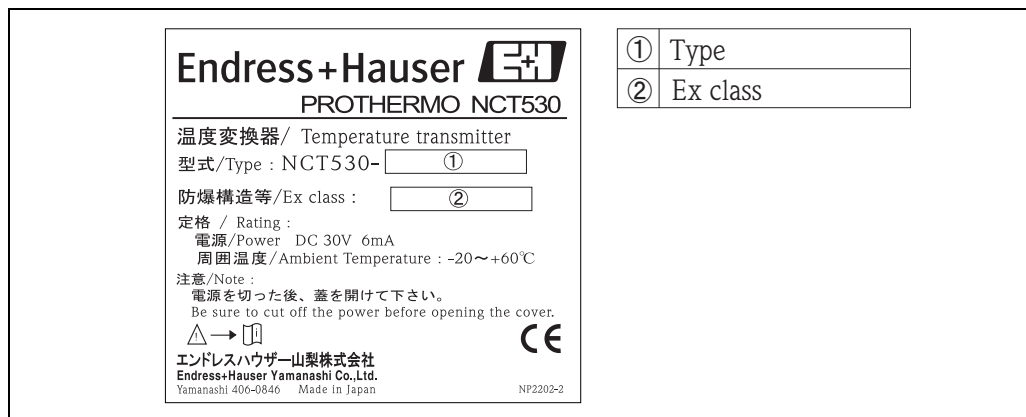

## 2.1.2 Ordering Information

### NCT530-7

<b>010</b>	<b>EN Converter:</b>			
	7	External type		
<b>020</b>	<b>EN Approval:</b>			
	0	Weather proof IP67		
	1	Ex d IIB T4, TIIIS		
	9	Special version, TSP-no. to be spec..		
<b>030</b>	<b>EN Cable Entry:</b>			
	G	2 x gland G1/2, External type		
	H	2 x gland G1/2, G3/4, External type		
	J	2 x gland G3/4, External type		
	Y	Special version, TSP-no.to be spec.		
<b>040</b>	<b>EN Element Type:</b>			
	1	Pt100, MRT		
	2	Pt100, MST		
	3	JPt100, MRT		
	4	JPt100, MST		
	9	Special version, TSP-no.to be spec.		
<b>050</b>	<b>EN Temperature Range:</b>			
	1	-50...+200°C		
	9	Special version, TSP-no.to be spec.		
<b>NCT530-</b>				Order code

## 2.2 Scope of delivery



Caution!

It is essential to follow the instructions concerning the unpacking, transport and storage of measuring instruments given in the chapter "Incoming acceptance, transport, storage" .

The scope of delivery consists of:

- Assembled instrument

Accompanying documentation:

- Brief Operating Instruction (this manual)

## 2.3 Registered trademarks

**HART**<sup>®</sup>

Registered trademark of HART Communication Foundation, Austin, USA

## 3 Installation

### 3.1 Incoming acceptance, transport, storage

#### 3.1.1 Incoming acceptance

Check the packing and contents for any signs of damage.  
Check the shipment, make sure nothing is missing and that the scope of supply matches your order.

#### 3.1.2 Transport



Caution!

Follow the safety instructions and transport conditions for instruments of more than 18 kg.

#### 3.1.3 Storage

Pack the measuring instrument so that is protected against impacts for storage and transport. The original packing material provides the optimum protection for this.  
The permissible storage temperature is -20... + 60 °C



### 3.2 Installation conditions

#### 3.2.1 Dimensions

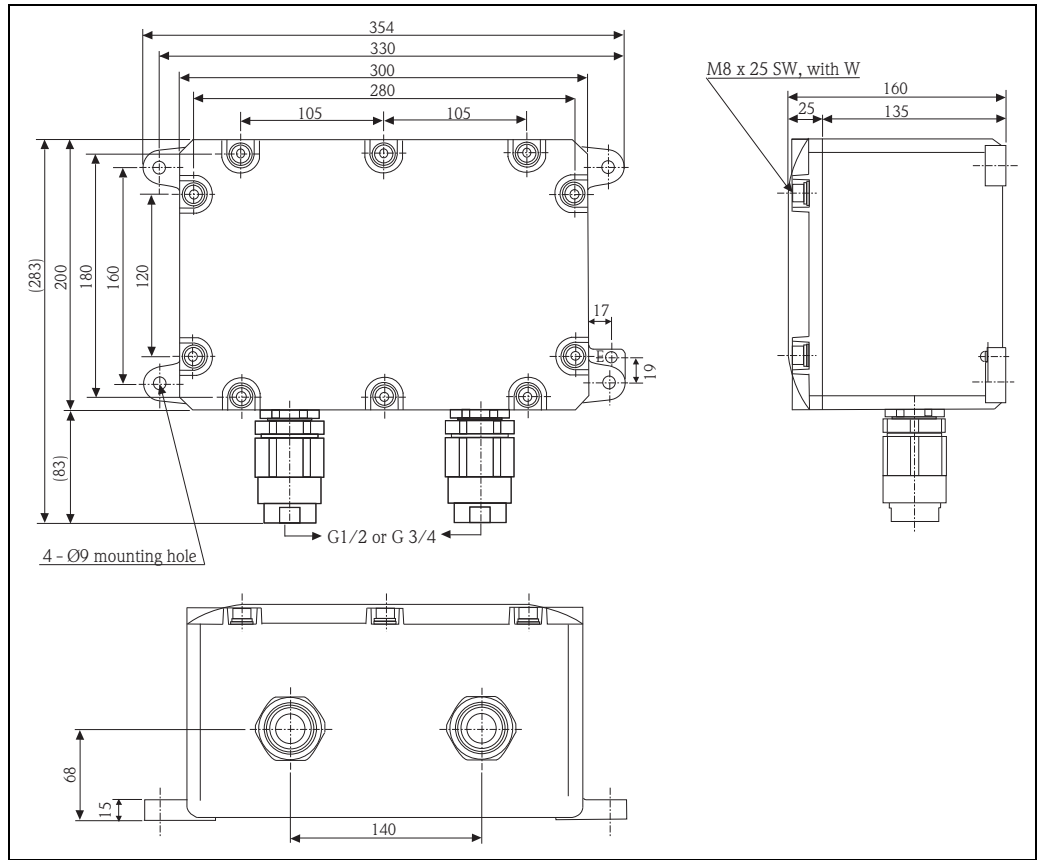

### 3.2.2 Installation Example

NCT530 installation is provided by customer. The mounting holes of NCT530 are  $\varnothing 9$ .

#### Installation with NMS5

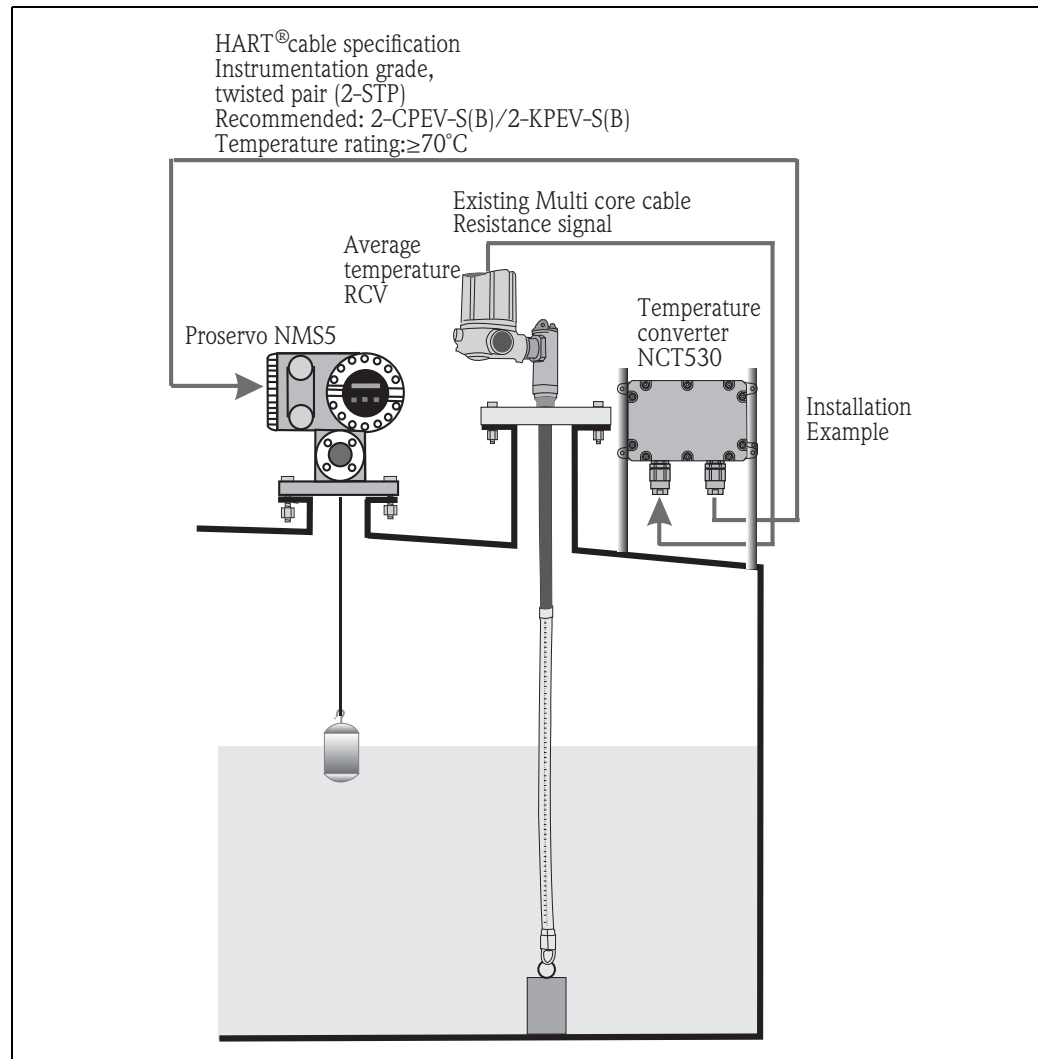

### Installation with TGM5

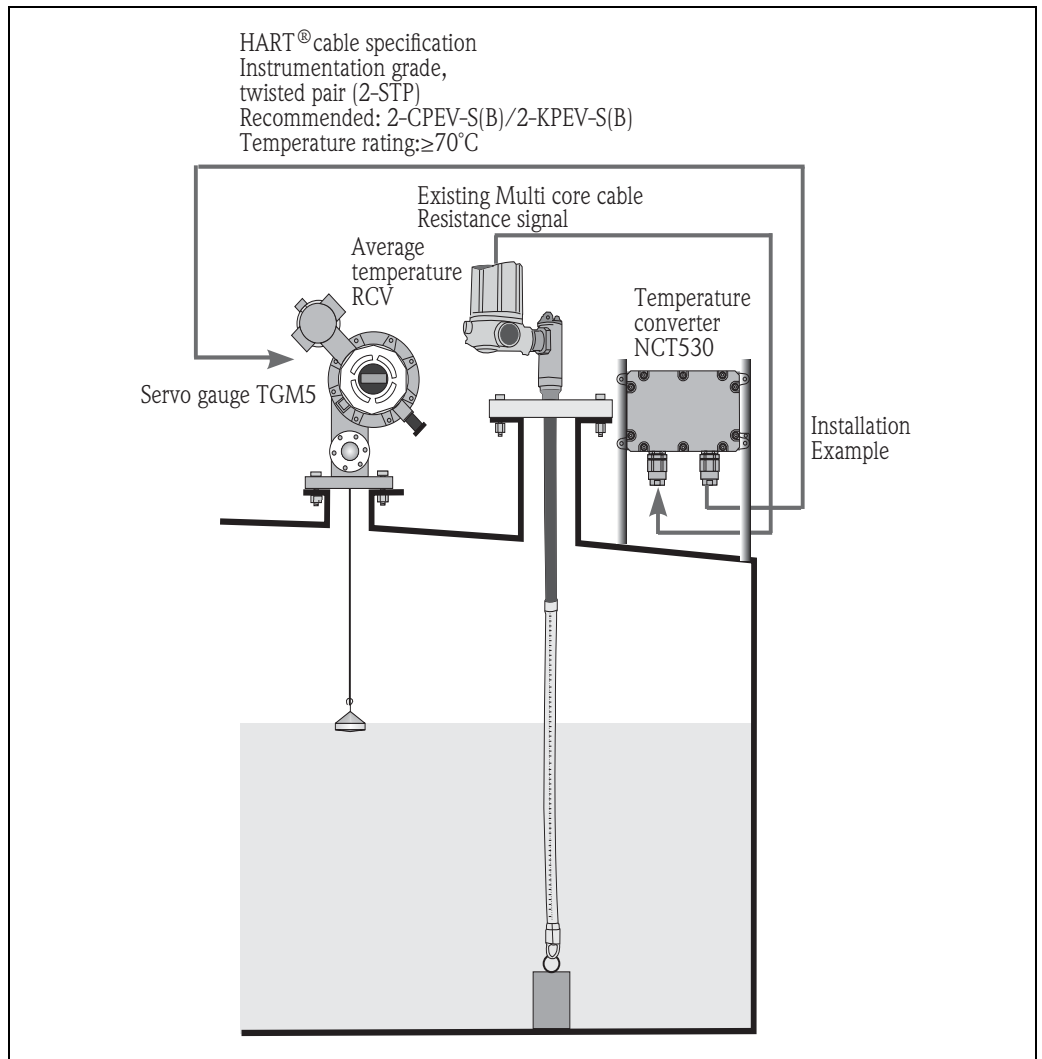

## 4 Wiring

### 4.1 Installation procedure

- Turn host transmitter power OFF
- Open the host transmitter terminal box
- Disconnect RCV signal cables from the host transmitter terminals
- \* Mark each cable to avoid mis-connections!
- Connect each RCV signal cable to the NCT530 terminals
- Connect the RCV signal cable shield to RCV-side Frame Ground in NCT530
- Connect each HART<sup>®</sup> signal output from NCT530 to host transmitter (refer to host transmitter wiring diagram)
- Connect the HART<sup>®</sup> signal cable shield to HART<sup>®</sup>-side Frame Ground in NCT530
- Close and seal the NCT530 cover before turning host transmitter power ON.

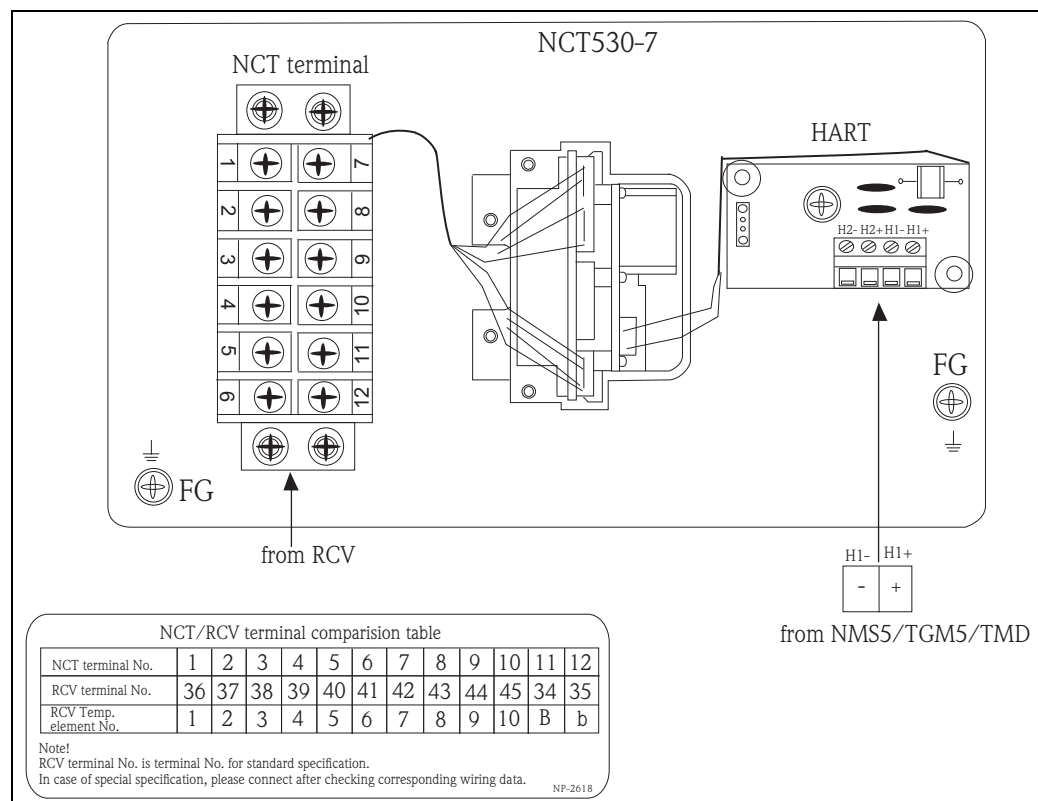

#### Note!

NCT530 is rated Flameproof enclosures "d".

Make sure to close the cover in NCT530, before turning host transmitter power ON.

# 5 Troubleshooting

## 5.1 Spare parts

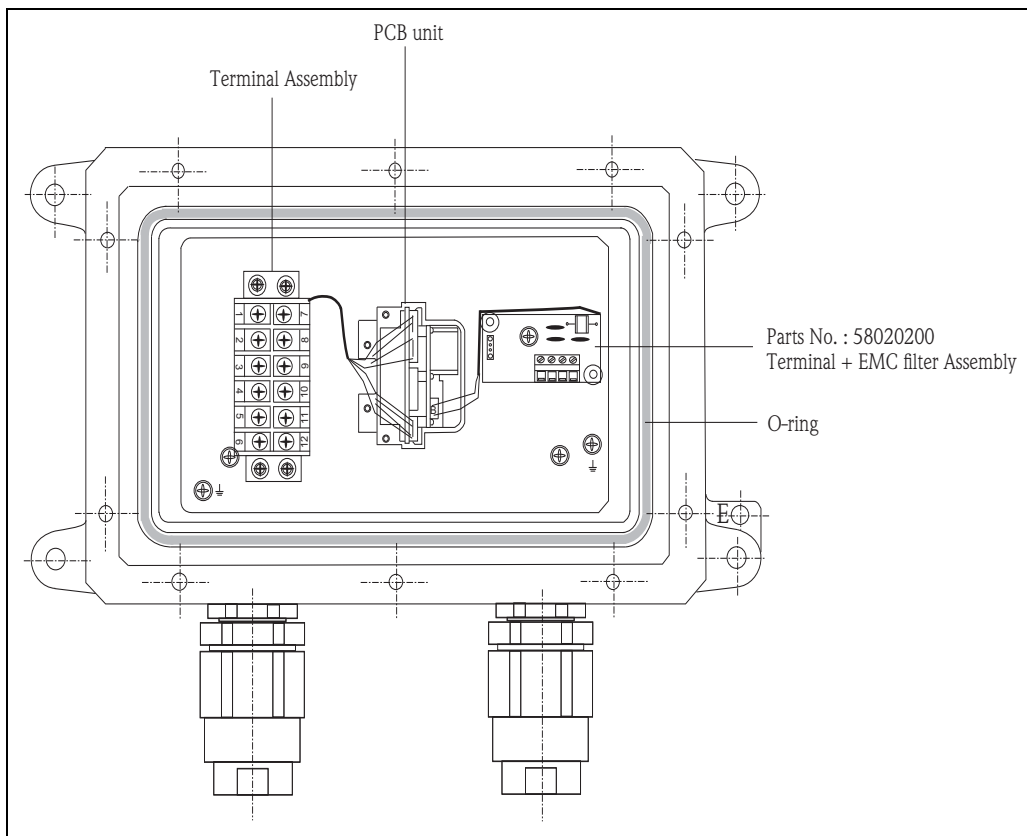

## 5.2 System error messages

Code	Description	Possible cause	Remedy
1	Common line open	Ground (common) line has open circuit. All of temperature element signal will be disabled or defected.	check connector attachment on the module; then check continuity on common (black) cable to #1 cable (red)
3~39	Element open	Temperature element signal cable ( #1 ~ 10) has open circuit.	check connector attachment on the module; then check continuity on pointed signal cable (#1 ~ 10)
4~40	Element short	Temperature element signal cable ( #1 ~ 10) has short circuit.	disengage connector from the module; then check continuity on pointed signal cable (#1 ~ 10)
23	#0 element over range	When reference #0 element has more than $\pm 1.1^{\circ}\text{C}$ deviation from $0^{\circ}\text{C}$ .	check power supply voltage on HART <sup>®</sup> terminal H+ and H-
24	Memory defect (ROM)	When a defect was discovered during whole memory parameter check. Cyclic data comparison between previous check sum to current one.	replace main CPU board
29	Element exposed	Liquid level dropped below #1 element position.	no liquid temperature measurement is available.
32	Low power supply	Supply voltage on HART <sup>®</sup> loop is below 16VDC from designated host instrument.	check power supply on the host instrument and consumption of connected loop powered HART <sup>®</sup> device
41	Memory defect (RAM)	A defect during Write and Read sequence was imcompleted.	replace main CPU board
42	Memory defect (EEROM)	A defect during Write command was imcompleted.	check the write command itself that is acceptable; if command is OK, replace main CPU board

## 5.3 Return

The following procedures must be carried out before the instruments is sent to Endress+Hauser for repair:

- Always enclose a duly completed "Declaration of Contamination" form. Only then can Endress +Hauser transport, examine and repair a returned device.
- Enclose special handling instructions if necessary, for example, safety data sheet as per EN 91/155/EEC.
- Remove all residue which may be present. Pay special attention to the gasket grooves and crevices where fluid may be present. This is especially important if the fluid is dangerous to health, e.g. corrosive, poisonous, carcinogenic, radioactive, etc.

Note!



A copy of the "Declaration of Contamination" is included at the end of this operating manual.

Caution!



No instrument should be sent back for repair without all dangerous material being completely removed first, e.g. in scratches or diffused through plastic. Incomplete cleaning of the instrument may result in waste disposal or cause harm to personnel. (burns, etc.). Any costs arising from this will be charged to the operator of the instrument.

## **5.4 Disposal**

In case of disposal, please separate the different components according to their material consistency.

## **5.5 Contact addresses of Endress+Hauser**

The addresses of Endress+Hauser are given on the back cover of this operating manual. If you have any questions, please do not hesitate to contact your E+H representative.

## 6 Technical data

<b>Temperature signal</b>	Maximum 10x Pt100
<b>Converted Temperature signal</b>	2-wire digital HART®
<b>Output</b>	DC30V 6mA
<b>Power consumption</b>	6mA at DC30V
<b>Grounding</b>	The NCT530 must be grounded to the tank potential before communication and power connections are made. The connections ( $A \geq 4\text{mm}^2$ ) from each outer ground plug of the NCT530 to the tank ground must be made before any other wiring connections are made. All grounding must be compliant with local and company regulations and checked before the equipment is commissioned.)
<b>Reference operating conditions</b>	Measuring range: -50 to +200C°
<b>Conversion accuracy</b>	$\pm 0.15\text{C}^\circ$ ( $\pm 0.27\text{F}^\circ$ )
<b>Ambient temperature range</b>	-20 to +60 C°
<b>Approval</b>	Ex class: IIIS Ex d IIB T4
<b>Protection class</b>	IP67
<b>Material</b>	Cover: AC7A-1, Body: AC7A-1, O-ring: NBR, Hexagon socket bolt: SUS304
<b>Cable Entry</b>	G1/2, G3/4
<b>Weight</b>	Approx. 10kg











# Declaration of contamination

Dear customer,

Because of legal determinations and for the safety of our employees and operating equipment, we need this "Declaration of contamination" with your signature before your order can be handled. Please, include the completely filled in declaration with the device and the shipping documents in any case. Add also safety sheets and / or specific handling instructions if necessary.

Type of device / sensor:	_____	Serial no.:	_____
Medium / concentration:	_____	Temperature:	_____ Pressure: _____
Cleaned with:	_____	Conductivity:	_____ Viscosity: _____

## Warning hints for medium used (mark the appropriate hints)

							
<input type="checkbox"/>	<input type="checkbox"/>	<input type="checkbox"/>	<input type="checkbox"/>	<input type="checkbox"/>	<input type="checkbox"/>	<input type="checkbox"/>	<input type="checkbox"/>
radioactive	explosive	caustic	poisonous	harmful to health	biologically hazardous	inflammable	safe

## Reason for return

\_\_\_\_\_

\_\_\_\_\_

## Company data

Company:	_____	Contact person:	_____
	_____		_____
Address:	_____	Department:	_____
	_____	Phone:	_____
	_____	Fax / e-mail:	_____
		Your order no.:	_____

I hereby certify that the returned equipment has been cleaned and decontaminated acc. to good industrial practices and is in compliance with all regulations. This equipment poses no health or safety risks due to contamination.

\_\_\_\_\_  
(Place, date)

\_\_\_\_\_  
(Company stamp and legally binding signature)

---

Endress + Hauser Yamanashi Co., Ltd.  
862-1 Mitsukunugi Sakaigawa-cho  
Fuefuki-shi Yamanashi,  
406-0846 Japan

Phone: ++81 55 266 4964  
Fax: ++81 55 266 4969  
<http://www.endress.com>

**Endress+Hauser**   
People for Process Automation