

System Specifications

ControlCare – Field-based Control System

Field Controllers and I/O modules

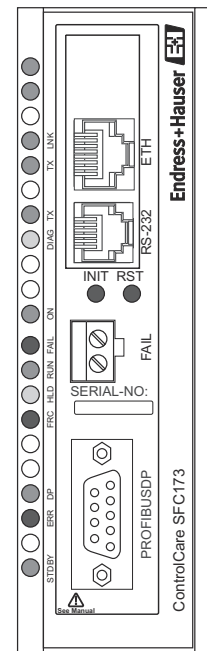
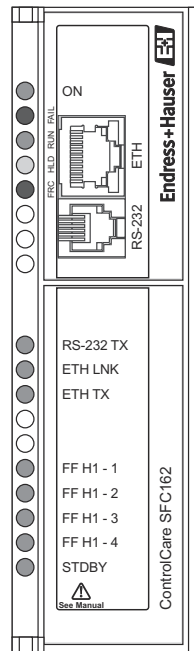

Table of Contents

Revision History	2	7	Output Modules	32
Product Version	2	7.1	SFC428 high density NO relay output	32
Registered Trademarks	2	7.2	SFC446 current and voltage output	34
1 Safety	3	8	Combined I/O Modules	36
1.1 Designated use	3	8.1	SFC432, SFC435, SFC438 voltage input and relay out- put	36
1.2 Installation, commissioning and operation	3	9	Accessories	38
1.3 Operational safety	3	10	Rack power requirement	39
2 General Specification	4		Index	44
2.1 Identification	4			
2.2 Function and system design	4			
2.3 Input	5			
2.4 Output	5			
2.5 Communication interface	5			
2.6 Operating conditions	5			
2.7 Mechanical construction	5			
2.8 Operability	7			
2.9 Power supply	7			
2.10 Certificates and Approvals	7			
2.11 Documentation	8			
3 Workstations	9			
4 Field Controllers	10			
4.1 SFC162 Field Controller (Foundation Fieldbus) ...	10			
4.2 SFC173 Field Controller (PROFIBUS)	12			
5 Power Supplies	14			
5.1 SFC050 AC backplane power supply	14			
5.2 SFC056 DC backplane power supply	16			
5.3 SFC252/SFC260 fieldbus power supplies (FF) ...	18			
5.4 SFC353 fieldbus power conditioner (FF)	20			
6 Input Modules	22			
6.1 SFC411 discrete input	22			
6.2 SFC415 DC discrete input - sink	24			
6.3 SFC420 switch input	26			
6.4 SFC444, SFC457 analog input	27			
6.5 SFC445 temperature input	29			
6.6 SFC441, SFC442, SFC467 pulse input	30			

Revision History

Product version	Manual	Changes	Remarks
2.00.xx	BA040S/04/en/01.05	Original Manual	
2.01.xx	BA040S/04/en/08.05	Product	<ul style="list-style-type: none"> ■ Isolation SFC162, SFC173, SFC050, SFC056 and SFC252/260 corrected: 500 VAC ■ Max. switching capacity of relay outputs on modules SFC428, SFC432, SFC435, SFC438 reduced to 30 VAC/30 VDC ■ Function block and link data Chapter 2.8
2.02.xx	BA040S/04/en/07.06	Product	<ul style="list-style-type: none"> ■ Chapter 10 revised (new rules for power supplies) ■ Power consumption SFC173, SFC444/457 higher ■ SFC162/173 function block support changed
2.03.xx	BA040S/04/en/06.07	Product	<ul style="list-style-type: none"> ■ Field Controller object links and VCRs increased ■ Labels SFC432, SFC435 and SFC438 updated
		Editorial	<ul style="list-style-type: none"> ■ Chapter 10: Power demand calculation revised
2.04.xx	BA040S/04/en/12.08	Product	<ul style="list-style-type: none"> ■ System specifications updated ■ Field Controller specifications updated
2.05.xx	BA040S/04/en/06.10	Product	<ul style="list-style-type: none"> ■ System specifications updated ■ Field Controller specifications updated

Product Version

Details of product version and the individual components of Application Designer Suite can be seen in the About ControlCare dialog:

Start=>Programs=>Endress+Hauser=>ControlCare=>Tools=>About ControlCare

Registered Trademarks

PROFIBUS®

Registered trademark of the PROFIBUS User Organisation, Karlsruhe Germany.

FOUNDATION™ Fieldbus

Trademark of the Fieldbus Foundation, Austin, TX 78759, USA

HART®

Registered trademark of the HART Communication Foundation, Houston, USA

Microsoft®, Windows®, Windows 2000®, Windows XP®, Windows 2003 Server®, Windows 2008 Server®, Windows 7®, Windows Vista® and the Microsoft logo are registered trademarks of the Microsoft Corporation.

Acrobat Reader® is a registered trade mark of the Adobe Systems Incorporated.

All other brand and product names are trademarks or registered trademarks of the companies and organisations in question

1 Safety

1.1 Designated use

ControlCare is a field-based control system comprising hardware and software modules. It can be used to visualize, monitor and control production processes. The hardware described in this manual allows a modular FOUNDATION Fieldbus or PROFIBUS Field Controller to be built. It comprises a number of separate units that may include power supply modules, power conditioning modules, fieldbus linking devices, controllers, interfaces, analog I/O and discrete I/O units. The approved usage of the individual units used in the system can be taken from the corresponding parts of these operating instructions.

1.2 Installation, commissioning and operation

ControlCare Field Controller modules have been designed to operate safely in accordance with current technical safety and EU directives. Essential to their use is the ControlCare Application Designer Suite, which allows control strategies to be created for both FOUNDATION Fieldbus and PROFIBUS applications. Field devices, links, junction boxes, cables and other hardware comprising the Fieldbus system must also be designed to operate safely in accordance with current technical safety and EU directives.

If devices are installed incorrectly or used for applications for which they are not intended, or if the controller is not configured correctly, it is possible that dangers may arise. For this reason, the system must be installed, connected, configured, operated and maintained according to the instructions in this and the associated manuals: personnel must be authorised and suitably qualified.

1.3 Operational safety

Location

Field Controllers must be mounted in a permanent and weather-protected location in a safe area. The environment shall be a metal cabinet or an installation frame with a well grounded mounting plane. The environment shall be protected.

Hazardous areas

The controller must be connected to networks operating in explosion hazardous areas via barriers or other safety components. When installing components in explosion hazardous areas:

- Ensure that all installation and maintenance personnel are suitably qualified
- Check that all equipment has the appropriate safety certificates
- Observe the specifications in the device certificates as well as national and local regulations.

This topic is discussed in BA013S (FF Guidelines) and BA034S (PROFIBUS Guidelines).

EMC

All modules are suitable for industrial use and conform with the following standard, see Appendix:

- EN 61326: 1997/A1: 1998
Interference emission: Class A apparatus
Interference immunity: as per Annex A, industrial environment

Depending upon the environment in which the bus is operating, particular attention should be paid to the grounding of the bus cables. This topic is discussed in BA013S (FF Guidelines) and BA034S (PROFIBUS Guidelines).

Technical improvement

Endress+Hauser reserves the right to make technical improvements to its software and equipment at any time and without prior notification. Where such improvements have no effect on the operation of the equipment, they are not documented. If the improvements affect operation, a new version of the operating instructions is normally issued.

2 General Specification

2.1 Identification

Item	Description
Manufacturer	Endress+Hauser
Designation	ControlCare – Field-based Control System

2.2 Function and system design

Item	Description
Designated use	Visualisation, monitoring and control of production processes
Workstations	PCs for Operation, Engineering, Maintenance etc.. Each workstation can be dedicated to a single function, or functions can be combined as required. Type as per functional specification, see Chapter 3 for typical configuration.
Applications	<ul style="list-style-type: none"> ■ Control Application Designer ■ ControlCare P View ■ FieldCare Network engineering and control strategy configuration tool Scalable SCADA program Asset management tool (FDT) for PROFIBUS and HART devices
Control modes	<ul style="list-style-type: none"> ■ Continuous via FF function blocks, standard and custom for any Field Controller ■ Discrete ■ Hybrid (IEC 61131) ■ Hybrid with embedded I/O (IEC 61131)
System backbone	<ul style="list-style-type: none"> ■ Bus type ■ Media types ■ Data transmission speed ■ Max. Length ■ Communication load ■ Supported protocols Ethernet SSTP CAT 5 100/10 Mbps 100 m for CAT 5 cable Typically less than 70% FF HSE, Modbus TCP (All Ethernet TCP/IP protocols)
Data linking	<ul style="list-style-type: none"> ■ Type ■ Number of servers OPC client-server One server independent of number of controllers and protocol
Field Controllers	<ul style="list-style-type: none"> ■ SFC162 ■ SFC173 4 channel FF controller 100 Mbps HSE output 1 channel PROFIBUS DP controller 100 Mbps HSE output
Bridges	<ul style="list-style-type: none"> ■ Ethernet/FF H1 ■ Ethernet/PROFIBUS DP Built into SFC162 Field Controller Built into SFC173 Field controller
Gateways	<ul style="list-style-type: none"> ■ Ethernet/PROFIBUS DP ■ PROFIBUS DP/PA FXA720 interface (with integrated web server) 3rd party. e.g. Pepperl+Fuchs SK1/SK2 or Siemens
I/O	<ul style="list-style-type: none"> ■ Max. 14 I/O racks when using local I/O ■ Max. 832 I/O points per Field Controller ■ Foundation Fieldbus H1 ■ PROFIBUS DP/PA ■ Temperature, analog, discrete, pulse and other signals via local or Remote I/O ■ MODBUS as slave, master or master and slave via Modbus TCP or RS-232C
Integrity	<ul style="list-style-type: none"> ■ Modules with failure circuit with LED and relay output ■ Redundant power supplies ■ HSE bridging ■ Back-up LAS in field devices for FF ■ Field control (loop integrity) for FF devices

2.3 Input

Item	Description
Signal input	Via local or remote I/O. The following local modules are available, see Chapter 6 and 7: <ul style="list-style-type: none"> ■ SFC411: discrete input ■ SFC415: DC discrete input - sink ■ SFC420: switch input ■ SFC444: SFC457 analog input ■ SFC445: temperature input ■ SFC441, SFC442, SFC467: pulse input ■ SFC432, SFC435, SFC438: combined voltage input and relay output

2.4 Output

Item	Description
Signal output	Via local or remote I/O. The following local modules are available, see Chapter 6 and 7: <ul style="list-style-type: none"> ■ SFC428: high density NO relay output ■ SFC446: current and voltage output ■ SFC432, SFC435, SFC438: combined voltage input and relay output

2.5 Communication interface

Item	Description
Digital interfaces	<ul style="list-style-type: none"> ■ 4x FOUNDATION Fieldbus H1 via SFC162 Field Controller ■ 1x PROFIBUS DP/PA via SFC173 Field Controller ■ MODBUS via Modbus TCP or RS-232C port on Field Controller SFC162 and SFC173

2.6 Operating conditions

Item	Description				
Installation	For indoor use (steel cabinet or or mounting frame in weather-protected environment)				
Environment	<table border="0" style="width: 100%;"> <tr> <td style="width: 50%; vertical-align: top;"> <ul style="list-style-type: none"> ■ Ambient temperature range ■ Storage temperature range ■ Humidity range: </td> <td style="width: 50%; vertical-align: top;"> 0°C - 60 °C -20°C - 80 °C SFC162, SFC173 excepted, see Chapter 4.1 20% - 90% RH, non-condensing. </td> </tr> <tr> <td style="vertical-align: top;"> <ul style="list-style-type: none"> ■ Electromagnetic compatibility </td> <td style="vertical-align: top;"> To EN 61326-1 Interference emission: Class A apparatus Interference immunity: as per Annex A, industrial environment </td> </tr> </table>	<ul style="list-style-type: none"> ■ Ambient temperature range ■ Storage temperature range ■ Humidity range: 	0°C - 60 °C -20°C - 80 °C SFC162, SFC173 excepted, see Chapter 4.1 20% - 90% RH, non-condensing.	<ul style="list-style-type: none"> ■ Electromagnetic compatibility 	To EN 61326-1 Interference emission: Class A apparatus Interference immunity: as per Annex A, industrial environment
<ul style="list-style-type: none"> ■ Ambient temperature range ■ Storage temperature range ■ Humidity range: 	0°C - 60 °C -20°C - 80 °C SFC162, SFC173 excepted, see Chapter 4.1 20% - 90% RH, non-condensing.				
<ul style="list-style-type: none"> ■ Electromagnetic compatibility 	To EN 61326-1 Interference emission: Class A apparatus Interference immunity: as per Annex A, industrial environment				

2.7 Mechanical construction

Item	Description
Design	Modular units for mounting on SFC901 (4 unit) SFC910 (2 unit) backplane, see Fig. 2.1
Dimensions	WxHxD: 39.9 mm x137.0mm x141.5 mm; (1.57" x 5.39" x 5.57"),see also Fig. 2.2
Weight	Depends on module
Material	PC
Degree of protection	IP 20 with door closed, IP 00 with door open
Terminal blocks	Screw terminals: one wire 2 mm ² (14 AWG), two wires 0.5 mm ² (20 AWG), blocks removable

Backplane dimensions

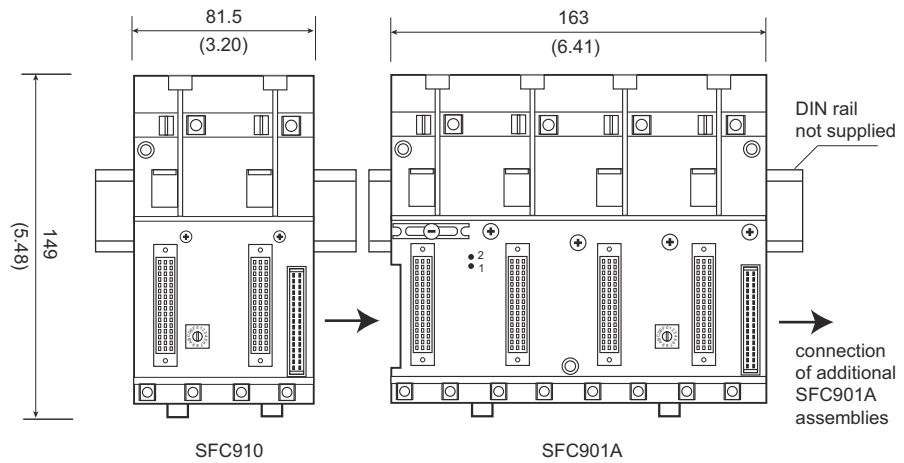
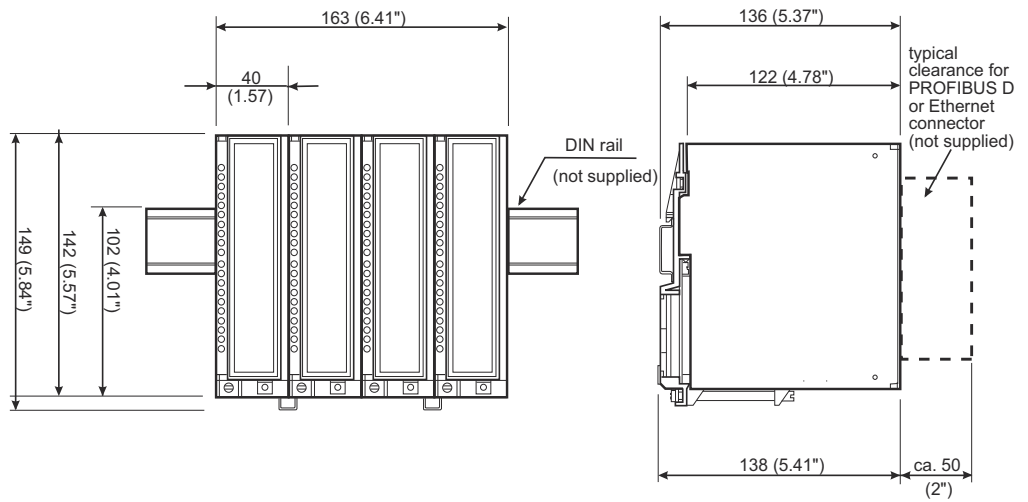

Fig. 2-1: Backplane dimensions (SFC901A, SFC910)

Module dimensions

All modules have the same dimensions.



Caution: allow 50 mm (2") clearance all round to ensure adequate ventilation

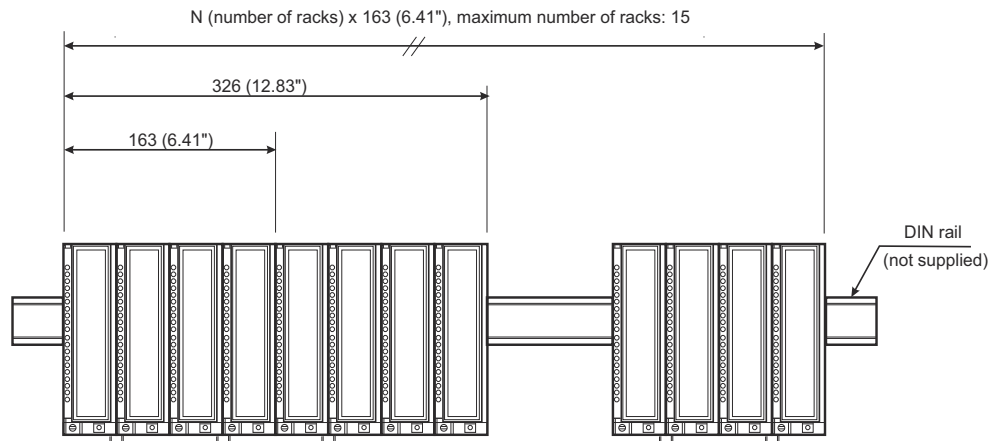

Fig. 2-2: Dimensions of ControlCare modules and racks

2.8 Operability

Item	Description
Configuration/Commissioning	ControlCare Application Designer network engineering and control strategy configuration suite
Function blocks	<ul style="list-style-type: none"> ■ SFC162: max. 250, four reserved Max. 50 of each hybrid function block type for IEC 61131 programming allowed ■ SFC173: max. 250, four reserved Max. 50 of each hybrid function block type for IEC 61131 programming allowed ■ Additional function blocks in the field devices (FF) ■ Dynamic Function Block instantiation ■ Application memory size: 2 MB including max. 1.5 MB for IEC 61131 programming
Block types	<ul style="list-style-type: none"> ■ Transducer blocks: Diagnostics, Display, I/O Hardware, PROFIBUS configuration, Temperature Input ■ Input blocks: Analog Input, Discrete Input, Multiple Analog Input, Multiple Discrete Input, Pulse Input ■ Control blocks: PID Control, Enhanced PID, Advanced PID, Step Output PID, Arithmetic, Splitter, Signal Characterizer, Cascade Signal Characterizer, Integrator, Analog Alarm, Enhanced Analog Alarm, Input Selector, Setpoint Ramp Generator, Timer, Lead-Lag, Output Selector/Dynamic Delimiter, Density, Constant, Constant and Contained RW, Flip.Flop and Edge Trigger, Advanced Equations, Analog, Discrete and Embedded Hybrid Function Blocks ■ Output blocks: Analog Output, Discrete Output, Multiple Analog Output, Multiple Discrete Output, PID Output
Links	<p>Device Revision 3</p> <ul style="list-style-type: none"> ■ SFC162: max. 512 FB links (Object Links), max. 128 HSE-HSE links ■ SFC173: max. 512 FB links (Object Links), max. 128 HSE-HSE links <p>Device Revision 4</p> <ul style="list-style-type: none"> ■ SFC162: max. 1024 FB links (Object Links), max. 256 HSE-HSE links ■ SFC173: max. 1024 FB links (Object Links), max. 256 HSE-HSE links
Communication	<p>Device Revision 3</p> <ul style="list-style-type: none"> ■ SFC162: 90 VCR Publishers and 90 VCR Subscribers per H1 channel ■ SFC162: LAS function ■ Control macrocycle: 150~ 6000 ms depending on size of application <p>In addition for Device Revision 4</p> <ul style="list-style-type: none"> ■ MVC for Supervision (Client/Server) ■ MVC for HSE Publishing/Subscribing (= additional 1024 HSE-HSE links)
Interoperability	<ul style="list-style-type: none"> ■ All Certified FF Devices can be used with ControlCare, see also official list ■ All Certified PROFIBUS DP/PA devices can be used with ControlCare, see GSD library
Operation screens ControlCare P View	<ul style="list-style-type: none"> ■ No. of screens limited by workstation memory only ■ Window display update period: 1 sec – 2 sec ■ Alarm management, Capacity: unlimited, Priority levels: 999 ■ Trending, trend scan period: min. 10 ms ■ Log reports, on demand, hourly, daily, weekly, monthly, shift report ■ Self-documentation function ■ Electronic instruction manual, File Format: Acrobat PDF, Acrobat Reader supplied
LED indicators	See individual modules, Chapters 4 to 7
Operating elements	See individual modules, Chapters 4 to 7

2.9 Power supply

Item	Description
Power modules	<ul style="list-style-type: none"> ■ SFC050 AC backplane power supply: ■ SFC056 DC backplane power supply See Chapter 5 for specifications
Fieldbus power modules	<ul style="list-style-type: none"> ■ SFC252 AC fieldbus power supply (FF), see Chapter 5 for specifications and Chapter 10 ■ SFC260 DC fieldbus power supply (FF), see Chapter 5 for specifications and Chapter 10 ■ SFC353 fieldbus power conditioner (FF), see Chapter 5 for specifications and Chapter 10 ■ For PROFIBUS PA: Pepperl+Fuchs SK1, SK2 or SK3 segment coupler or Siemens coupler or link See manufacturer's specifications

2.10 Certificates and Approvals

Item	Description
CE Mark	In attaching the CE Mark to a module, Endress+Hauser confirms that it conforms to the relevant EU directives.

2.11 Documentation

All documentation available at the time of release is included on the ControlCare CD-ROM and is installed in **Start=>Programs=>Endress+Hauser=ControlCare=Manuals** during set-up.

Component	Description	Document type	Designation	Order No.
System	ControlCare System Overview	Operating manual	BA016S/04/en	56004883
	ControlCare System Design	Operating manual	BA039S/04/en	Planned
	ControlCare System Specifications	Operating manual	BA040S/04/en	56004888
Software	Application Designer Overview	Operating manual	BA017S/04/en	70104301
	Application Designer: Local I/O Tutorial	Operating manual	BA032S/04/en	71095009
	Application Designer: FF Tutorial	Operating manual	BA019S/04/en	70101151
	Application Designer: PROFIBUS Tutorial	Operating manual	BA036S/04/en	70101152
	Application Designer: MODBUS Tutorial	Operating manual	BA037S/04/en	70101153
	Application Designer: IEC 61131-3 Ladder Logic Tutorial	Operating manual	BA038S/04/en	70101386
	Application Designer: IEC 61131-3 Structured Text Tutorial	Operating manual	BA056S/04/en	71060063
	Field Control (OPC) Servers	Operating manual	BA018S/04/en	71031428
	SFC162 Visitor	Operation manual	BA069S/04/en	71113457
Field Controller	Hardware Installation Guide	Operating manual	BA021S/04/en	56004885
	Commissioning and Configuration	Operating manual	BA035S/04/en	56004887
Function Blocks	Function Block Manual	Operating manual	BA022S/04/en	56004886
Set-Up	Getting Started	Operating manual	BA020S/04/en	56004884
General	FOUNDATION Fieldbus Guidelines	Operating manual	BA013S/04/en	70100707
	PROFIBUS Guidelines	Operating manual	BA034S/04/en	56004242

3 Workstations

ControlCare is supplied as a complete engineered suite. The workstations supplied will have been stipulated in the functional specification. The table below gives a typical configuration used at the time of writing.

General	IBM-compatible PCs for Operation, Engineering, Maintenance etc.. Each workstation can be dedicated to a single function, or functions can be combined as required.	
Operation system	ControlCare Application Designer Suite Release 2.02.xx has been tested and approved for the following operating systems: <ul style="list-style-type: none"> ■ Windows 2000 with SP4 ■ Windows XP with SP1, SP2 or SP3 ■ Windows 2003 Server with Second Edition SP1 and R2 ■ Windows Vista Premium, Business, Enterprise, Ultimate ■ Windows Server 2008, Standard Edition ■ Windows 7 Professional 	
Hardware (recommended)	<ul style="list-style-type: none"> ■ Processor Type ■ Main Memory (RAM) ■ Hard-disk (HDD) Capacity ■ Recommended Monitor ■ Monitor Resolution ■ Data Updating Cycle ■ CD-ROM Drive ■ Redundancy of operator Console 	Pentium 500 MHz processor 256 MB RAM 40 GB IDE or Higher 310 MB free space for installation directory 350 MB free space on the system drive 115 MB temporary free space 21", SVGA 1024x768 or better, 64k colours 1 sec - 2 sec CD-RW 40x/10x/40-IDE All workstations can be configured to access all data, allowing a full workstation redundancy
Power Supply	<ul style="list-style-type: none"> ■ Country specific 	
Max. No of stations	<ul style="list-style-type: none"> ■ Unlimited 	
Printer	<ul style="list-style-type: none"> ■ Laser, Inkjet, dot matrix, b/w or colour as required 	

4 Field Controllers

4.1 SFC162 Field Controller (Foundation Fieldbus)

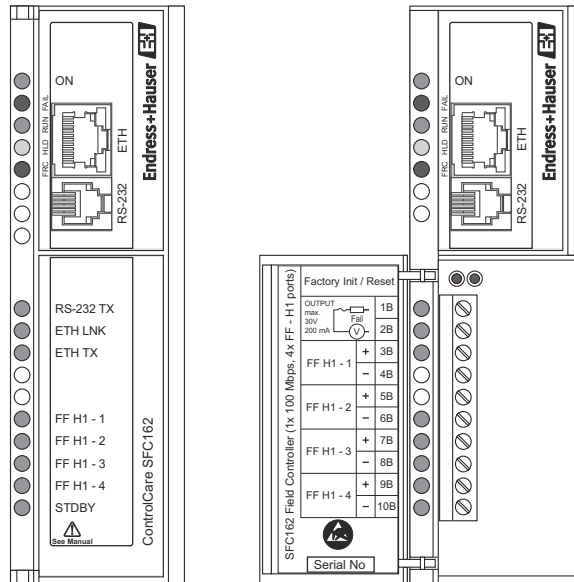

Fig. 4-1: SFC162 Foundation Fieldbus field controller showing front panel and connection compartment

Technical data

Item	Property	Specification
Function	Designated use	ControlCare Field Controller and Ethernet/FF linking device/bridge
	Integrity	HSE-HSE bridging, H1-HSE-H1 bridging, H1-H1 bridging
Fieldbus interface	Interface/protocol	Foundation Fieldbus (H1), LAS function
	Number of ports	4, independent, FF-H1
	Physical layer standard	IEC 61158-2
	Baud rate	31.25 kbit/s (H1)
	MAU Type	Passive (no bus power)
	Intrinsic safety	Not compliant, requires IS barriers and isolators
	Isolation	500 VAC (each channel)
Ethernet interface	Interface/protocol	Foundation Fieldbus HSE, Modbus TCP
	Physical layer standard	10Base-T/100Base-TX
	Transmission rate	10 Mbit/s or 100 MBit/s, automatically detected
	Connector	RJ-45
Modbus RTU interface	Interface/protocol	Modbus
	Physical layer standard	EIA-232
	Baud rate	9.6 kbit/s, 19.2 kbit/s, 38.4 kbit/s, 57.6 kbit/s, 115.2 kbit/s, set in Application Designer
	Connector	RJ-12
Failure circuit	Output type	<ul style="list-style-type: none"> ■ NC relay with potential-free contact ■ Red FAIL LED on modules concerned
	Current rating	<ul style="list-style-type: none"> ■ Max. 200 mA, max. 30VDC
	Initial contact resistance	Max. 75 Ω
	Response time	<ul style="list-style-type: none"> ■ Operating time: 10 ms (hardware) ■ Release time: 10 ms (hardware)
	Isolation	500 VAC, 50/60 Hz for 1 minute between coil and contacts
	Electric service life	Min. 100,000 operations

Operating Conditions	Installation	For indoor used (cabinet or protected environment)
	Environment	Ambient temperature range: 0°C - 60 °C
		Storage temperature range: -20°C - 25 °C (to achieve ten year battery life), otherwise 0°C - 80 °C
		Humidity range: 20% - 90% RH, non-condensing
		Electromagnetic compatibility: to ensure conformance to the system standard connector SFC903 must be used and the ground lead connected to the cabinet grounding point
Mechanical Construction	Design	Modular unit for mounting on SFC901A rack
	Dimensions (W x H x D)	39.9 mm x137.0mm x141.5 mm; (1.57" x 5.39" x 5.57")
	Weight	0.380 kg
	Material	PC
	Degree of protection	IP 20 with door closed, IP 00 with door open
	Terminal blocks	<ul style="list-style-type: none"> ■ Screw terminals: one wire 2 mm² (14 AWG) two wires 0.5 mm² (20 AWG)
CPU	<ul style="list-style-type: none"> ■ NVRAM (Application): 2 MB including max.1.5 MB for IEC61131 programming ■ SDRAM 8 MB, Flash 8 MB (older revisions 4 MB) 	
Operability see also Chapter 2.8	Configuration	Via ControlCare Application Designer Suite
	LED indicators	<ul style="list-style-type: none"> ■ ON: Green LED lights when powered up ■ FAIL: Red LED lights on controller fault ■ RUN: Green LED lights if controller running ■ HLD: Yellow LED lights if controller in monitor mode ■ FRC: Red LED flashes to indicate reset mode Red LED flashes to indicate no battery power Red LED lights if controller has a critical fault ■ RS232 TX: Green LED flashes for traffic on Modbus serial ■ ETH LNK: Green LED lights if Ethernet connected ■ ETH TX: Green LED flashes for traffic on Ethernet ■ FF H1-1: Green LED flashes for traffic on H1 Channel 1 ■ FF H1-2: Green LED flashes for traffic on H1 Channel 2 ■ FF H1-3: Green LED flashes for traffic on H1 Channel 3 ■ FF H1-4: Green LED flashes for traffic on H1 Channel 4 ■ STDBY: Green LED lights if module in stand-by mode
	Pushbutton	Two pushbuttons in connection compartment for controlling RESET and factory initialisation procedures
	DIP switch, 1-5	Accessible from rear of module: to enable/disable 1) battery, 2) not used, 3) simulation, 4) watchdog, 5) not used
Power Supply	Voltage	+5 VDC ± 2%, available on backplane
	Current	0.7A
	Power consumption	3.5 W
Certificates and Approvals	CE Mark	In attaching the CE Mark to a module, Endress+Hauser confirms that it conforms to the relevant EU directives.

4.2 SFC173 Field Controller (PROFIBUS)

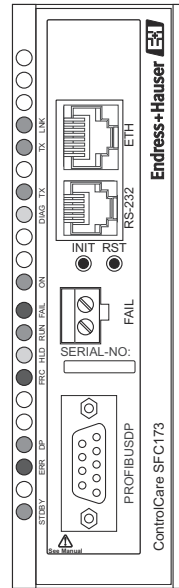

Fig. 4-2: SFC173 PROFIBUS field controller showing front panel and connection elements

Technical data

Item	Property	Specification
Function	Designated use	ControlCare field controller and Ethernet/PROFIBUS DP bridge
	Integrity	HSE bridging
Fieldbus interface	Interface/protocol	PROFIBUS DP
	Number of ports	1
	Physical layer standard	RS-485
	Baud rate	9.6 kbit/s to 12 Mbits/s, selectable in Application Designer
	MAU Type	Passive (no bus power)
	Intrinsic safety	Not compliant, requires IS coupler or link
	Isolation	500 VAC
Ethernet interface	Interface/protocol	Foundation Fieldbus HSE, Modbus TCP
	Physical layer standard	10Base-T/100Base-TX
	Transmission rate	10 Mbit/s or 100 MBit/s, automatically detected
	Connector	RJ-45
Modbus RTU interface	Interface/protocol	Modbus
	Physical layer standard	EIA-232
	Baud rate	9.6 kbit/s, 19.2 kbit/s, 38.4 kbit/s, 57.6 kbit/s 115.2 kbit/s, set in Application Designer
	Connector	RJ-12
Failure circuit	Output type	<ul style="list-style-type: none"> ■ NC relay with potential-free contact ■ Red FAIL LED on modules concerned
	Current rating	<ul style="list-style-type: none"> ■ Max. 200 mA , max. 30VDC
	Initial contact resistance	Max. 75 Ω
	Response time	<ul style="list-style-type: none"> ■ Operating time: 10 ms (hardware) ■ Release time: 10 ms (hardware)
	Isolation	500 VAC, 50/60 Hz for 1 minute between coil and contacts
	Electric service life	Min. 100,000 operations
Operating Conditions	Installation	For indoor used (cabinet or protected environment)
	Environment	Ambient temperature range: 0°C - 60 °C
		Storage temperature range: -20°C - 25 °C (to achieve ten year battery life), otherwise 0°C - 80 °C
	Humidity range: 20% - 90% RH, non-condensing	

CPU	<ul style="list-style-type: none"> ■ NVRAM (Application): 2 MB including max.1.5 MB for IEC61131 programming ■ SDRAM 8 MB, Flash 8 MB (older revisions 4 MB) 	
Mechanical Construction	Design	Modular unit for mounting on SFC901A or SFC910 rack
	Dimensions (W x H x D)	39.9 mm x137.0mm x141.5 mm; (1.57" x 5.39" x 5.57")
	Weight	0.305 kg
	Material	PC
	Degree of protection	IP 20
	Terminal blocks	<ul style="list-style-type: none"> ■ Screw terminals: one wire 2 mm² (14 AWG) two wires 0.5 mm² (20 AWG)
Operability see also Chapter 2.8	Configuration	Via ControlCare Application Designer Suite
	LED indicators	<ul style="list-style-type: none"> ■ LNK: Green LED lights if Ethernet connected ■ TX: Green LED flashes for traffic on Modbus TCP ■ TX: Green LED flashes for traffic on Modbus serial ■ DIAG: Yellow LED lights RS-232 diagnostic to PB chip ■ ON: Green LED lights if powered up ■ FAIL: Red LED lights on controller fault ■ RUN: Green LED lights when controller running ■ HLD: Yellow LED lights if controller in monitor mode ■ FRC: Red LED flashes to indicate reset mode Red LED flashes to indicate no battery power Red LED lights if controller has a critical fault ■ DP: Green LED lights when controller is only master and is in state OPERATE Green LED flashes if there are one or more additional masters (Class 1 or 2) to which the token is passed ■ ERR: Red LED lights if one or more dedicated slaves are not configured for cyclic data exchange ■ STDBY: Green LED lights if module in stand-by mode
	Pushbutton	Two pushbuttons in connection compartment for controlling RESET and factory initialisation procedures
	DIP switch, 1-5	Accessible from rear of module: to enable/disable 1) battery, 2) not used, 3) simulation, 4) watchdog, 5) not used
Power Supply	Voltage	+5 VDC ± 2%, available on backplane
	Current	0.70 A
	Power consumption	3.50 W
Certificates and Approvals	CE Mark	In attaching the CE Mark to a module, Endress+Hauser confirms that it conforms to the relevant EU directives.

5 Power Supplies

5.1 SFC050 AC backplane power supply

Front view

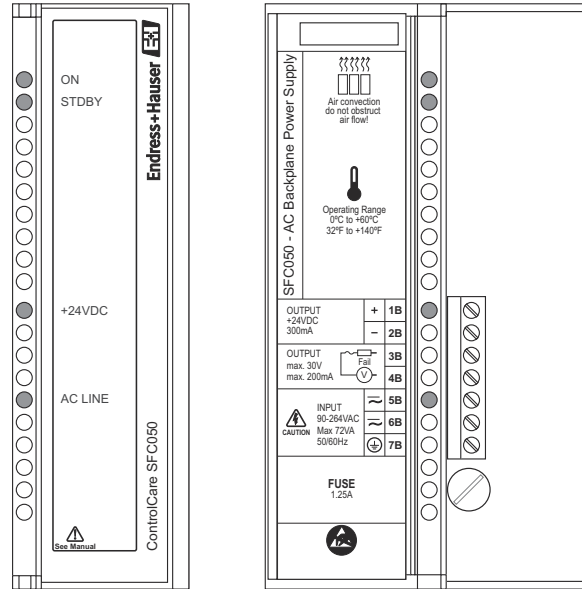

Fig. 5-1: SFC050 AC backplane power supply showing front panel and connection compartment

Description

The SFC050 AC power supply works independently or in conjunction with a second SFC050 redundant power supply module to increase power safety for the application. It is designed for an external voltage of (90 VAC – 264 VAC). When two redundant power supplies are used, this implies that only one will be providing energy to the system while the other one stands by for backup purposes. In the event of a failure, the backup will automatically assume operation. A relay is provided to indicate failure on each of the power supplies giving the user a chance to replace the faulty one.

The SFC050 module provides two voltage outputs:

- 5 VDC @ 3 A distributed via the rack backplane to feed module circuits
- 24 VDC @ 300 mA for external use through the terminals 1B and 2B.

The AC voltage input, the 5 VDC output and the 24 VDC output are all mutually isolated.

Use

The SFC050 backplane power supply can be used in four ways:

- A single SFC050 unit is required when rack current consumption is less than 3A
- Several SFC050 units are used together when rack current consumption is more than 3A
- Two SFC050 units are used if power redundancy (split power operation) is required
- Two SFC050 units are used if power redundancy (standby operation) is required

The mode of operation (single, several or redundant) is set by means of jumpers on the printed circuit board, see Chapter 3.5.2, Operating Instructions Field Controller, BA021S/04/en.

Technical data

Item	Property	Specification
Function	Designated use	AC power supply for backplane and external load
	Integrity	Supports redundant power operation (split power, standby)
Output 1	Output voltage	5.2 VDC \pm 2% for backplane
	Current	Max. 3 A
	Residual ripple	Max. 100 mV _{pp}
Output 2	Output voltage	24 VDC \pm 10% for external use
	Current	Max. 300 mA
	Residual ripple	Max. 200 mV _{pp}
Failure circuit	Output type	■ NC relay with potential-free contact
	Current rating	■ Max. 200 mA , max. 30VDC
	Initial contact resistance	Max. 75 Ω
	Response time	■ Operating time: 10 ms (hardware) ■ Release time: 10 ms (hardware)
	Isolation	500 VAC, 50/60 Hz for 1 minute between coil and contacts
	Electric service life	Min. 100,000 operations
Operating Conditions	Installation Environment	See Section 2.5
Mechanical Construction	Design	See Section 2.6
	Weight	0.445 kg
	Terminal blocks	■ Screw terminals: one wire 2 mm ² (14 AWG) two wires 0.5 mm ² (20 AWG)
Operability	LED indicators	■ ON: Green LED indicates backplane power present ■ STDBY: Green LED indicates stand-by operation ■ +24VDC: Green LED indicates power on ■ AC LINE: Green LED indicates presence of line voltage
	Jumper (on PCB)	■ CH1: sets enabled E or redundant R operation ■ W1: set when module redundant
Power supply	AC external supply	90 VAC to 264 VAC, 50/60 Hz
	Power consumption	max. 72 VA, depending upon load
	Galvanic isolation	Mutual isolation >500 Vrms between input signal, internal output and external output
	Fuse	1.25 A
Certificates and Approvals	CE Mark	In attaching the CE Mark to a module, Endress+Hauser confirms that it conforms to the relevant EU directives.

5.2 SFC056 DC backplane power supply

Front view

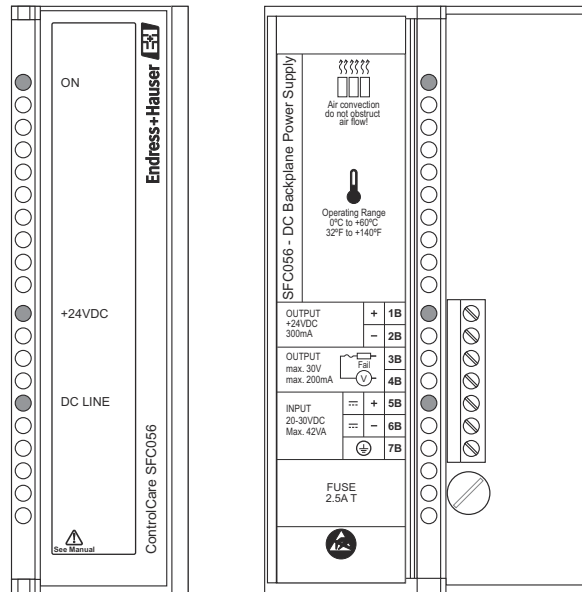

Fig. 5-2: SFC056 DC backplane power supply showing front panel and connection compartment

Description

The SFC056 module is used to power the backplane and all the modules connected to it. It is designed for an external voltage of 20VDC – 30VDC. The module provides two voltage outputs:

- 5 VDC @ 3 A distributed via the rack backplane to feed module circuits
- 24 VDC @ 300 mA for external use through the terminals 1B and 2B.

The DC voltage input, the 5 VDC output and the 24 VDC output are all mutually isolated.

Use

The SFC056 backplane power supply can be used in three ways:

- A single SFC056 unit is required when rack current consumption is less than 3A
- Several SFC056 units are used together when rack current consumption is more than 3A
- Two SFC050 units are used if power redundancy (split power operation) is required

The mode of operation (single, several or redundant) is set by means of jumpers on the printed circuit board, see Chapter 3.5.2, Operating Instructions Field Controller, BA021S/04/en.

Technical data

Item	Property	Specification
Function	Designated use	DC power supply for backplane and external load
	Integrity	Supports redundant power operation (split power)
Output 1	Output voltage	5.2 VDC \pm 2% for backplane
	Current	Max. 3 A
	Residual ripple	Max. 100 mV _{pp}
Output 2	Output voltage	24 VDC \pm 10% for external use
	Current	Max. 300 mA
	Residual ripple	Max. 200 mV _{pp}
Failure circuit	Output type	■ NC relay with potential-free contact
	Current rating	■ Max. 200 mA , max. 30VDC
	Initial contact resistance	Max. 75 Ω
	Response time	■ Operating time: 10 ms (hardware) ■ Release time: 10 ms (hardware)
	Isolation	500 VAC, 50/60 Hz for 1 minute between coil and contacts
	Electric service life	Min. 100,000 operations
Operating Conditions	Installation Environment	See Section 2.5
Mechanical Construction	Design	See Section 2.6
	Weight	0.460 kg
	Terminal blocks	■ Screw terminals: one wire 2 mm ² (14 AWG) two wires 0.5 mm ² (20 AWG)
Operability	LED indicators	■ ON: Green LED indicates backplane power present ■ +24VDC: Green LED indicates power on ■ DC LINE: Green LED indicates presence of line voltage
Power supply	DC external supply	20 VDC to 30 VDC
	Power consumption	42 VA, depending upon load
	Galvanic isolation	Mutual isolation >500 Vrms between input signal, internal output and external output
	Fuse	2.5 A time-lag
Certificates and Approvals	CE Mark	In attaching the CE Mark to a module, Endress+Hauser confirms that it conforms to the relevant EU directives.

5.3 SFC252/SFC260 fieldbus power supplies (FF)

Front view

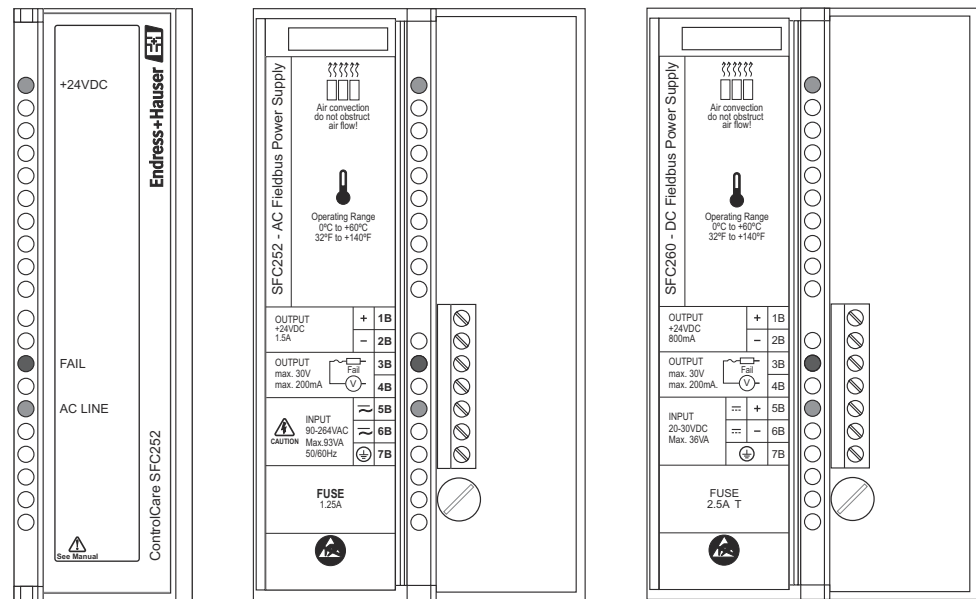

Fig. 5-3: SFC252/SFC260 fieldbus power supplies showing front panel (SFC252) and connection compartments

Description

The modules SFC252 and SFC260 are 24 VDC fieldbus power supplies for use with e.g. a SFC363 power conditioner. The only difference between them is the external supply voltage that they require:

- SFC252 (90 VAC – 264 VAC)
- SFC260 (20 VDC – 30 VDC)

The SFC252 fieldbus power supply is non-intrinsically safe with an universal AC input (90 to 264 VAC, 50/60 Hz or DC equivalent), and a 24 VDC output. The output is galvanically isolated from the input, with short-circuit and overcurrent protection, ripple and fault indication, appropriate to feed fieldbus devices. There is no electrical connection to the backplane.

The SFC260 fieldbus power supply non-intrinsically safe with a DC input (20 to 30 VDC) and a 24 VDC output. The output is galvanically isolated from the input, with short-circuit and overcurrent protection, ripple and fault indication, appropriate to feed fieldbus devices. There is no electrical connection to the backplane.

The fieldbus power supplies can feed up to 4 fully loaded fieldbus networks. Both are equipped with a short-circuit protection circuit which triggers on overload or short-circuit. When the outputs return to normal conditions of operation, the circuit is automatically switched on. Both modules permit redundancy without requiring any component coupled to their output.

Technical data

Item	Property	Specification
Function	Designated use	AC (SFC252) and DC (SFC260) fieldbus power supplies
Output	No. of outputs	4
	Output voltage	24 VDC \pm 1%
	Current	<ul style="list-style-type: none"> ■ SFC252: 1500 mA ■ SFC260: 800 mA
	Residual ripple	Max. 20 mV
Failure circuit	Output type	<ul style="list-style-type: none"> ■ NC relay with potential-free contact
	Current rating	<ul style="list-style-type: none"> ■ Max. 200 mA , max. 30VDC
	Initial contact resistance	Max. 75 Ω
	Response time	<ul style="list-style-type: none"> ■ Operating time: 10 ms (hardware) ■ Release time: 10 ms (hardware)
	Isolation	500 VAC, 50/60 Hz for 1 minute between coil and contacts
	Electric service life	Min. 100,000 operations
Operating Conditions	Installation Environment	See Section 2.5
Mechanical Construction	Design	See Section 2.6
	Weight	0.440 kg
	Terminal blocks	<ul style="list-style-type: none"> ■ Screw terminals: one wire 2 mm² (14 AWG) two wires 0.5 mm² (20 AWG)
Operability	LED indicators	<ul style="list-style-type: none"> ■ +24VDC: Green LED indicates power on ■ FAIL: Red LED indicates circuit failure ■ xx LINE: Green LED indicates presence of line voltage
Power supply	External supply	<ul style="list-style-type: none"> ■ SFC252: 90 VAC to 264 VAC, 50/60 Hz ■ SFC260: 20 VDC to 30 VDC
	Power consumption	<ul style="list-style-type: none"> ■ SFC252: Max. 93 VA ■ SFC260: Max. 36 W
	Galvanic isolation	Mutual isolation >500 Vrms between input signal, internal output and external output
	Fuse	<ul style="list-style-type: none"> ■ SFC252: 1.25 A ■ SFC260: 2.5 A time-lag
Certificates and Approvals	CE Mark	In attaching the CE Mark to a module, Endress+Hauser confirms that it conforms to the relevant EU directives.

5.4 SFC353 fieldbus power conditioner (FF)

Front View

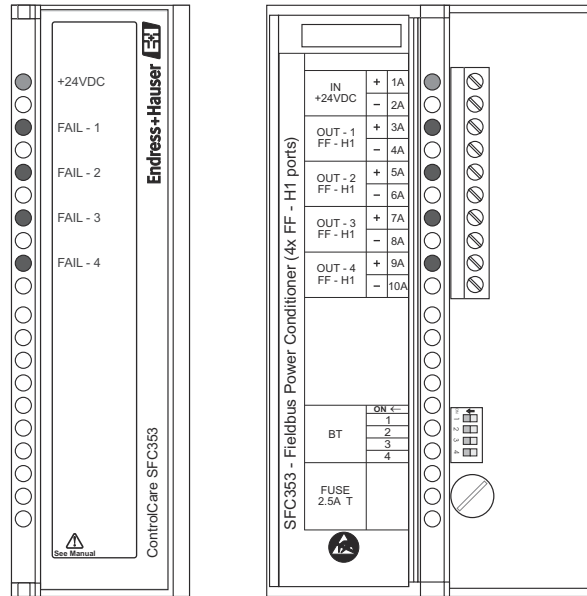

Fig. 5-4: SFC353 fieldbus power conditioner showing front panel and connection compartment

Description

The SFC353 fieldbus power conditioner provides power for fieldbus networks in accordance with Standard IEC 61158-2. It has four, non-intrinsically safe outputs. If an output is connected to a network operating in an explosion hazardous area, a suitable barrier must be connected between it and the field.

Each output is provided with a fieldbus terminator which can be switched into the circuit via the DIP switches behind the module door. The green "ON" LED lights when 24 VDC is supplied to the module. The red "FAIL" LED lights if a short-circuit is detected on the associated output.

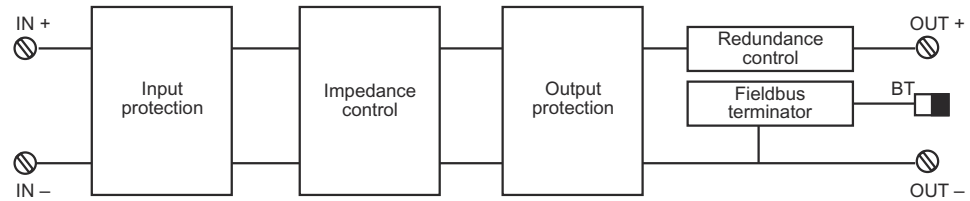

Fig. 5-5: Block diagram of SFC353 fieldbus output

The SFC353 fieldbus power conditioner is a non-isolated, active impedance control device. It provides an output impedance which, in parallel with the two bus terminators (a 100 Ω resistor in series with a 1 mF capacitor) required by the standard, results in a purely resistive line impedance for a broad frequency range.

The power is conditioned to provide an output circuit with an impedance greater than 3 kΩ in parallel with two terminators of 100 Ω ±2% each. This results in a line impedance of about 50 Ω. This impedance can be implemented in passive mode (50 Ω resistance in series with a 100 mH inductance) or in an active mode, through an impedance control circuit. Figure 4-5 shows the device block diagram.

Technical data

Item	Property	Specification
Function	Designated use	Power conditioner for 4x FF H1 (IEC 61158-2) bus segments
	Integrity	Supports redundant use
Output	No. of outputs	4x FF H1
	Current	max. 1500 mA, 340 mA per channel
	Attenuation	10dB in the input power ripple @60 Hz
Operating Conditions	Installation Environment	See Section 2.5
Mechanical Construction	Design	See Section 2.6
	Weight	0.270 kg
	Terminal blocks	<ul style="list-style-type: none"> ■ Screw terminals: one wire 2 mm² (14 AWG) two wires 0.5 mm² (20 AWG)
Operability	LED indicators	<ul style="list-style-type: none"> ■ ON: Green LED indicates 24 V power on ■ FAIL x: Red LED indicates output circuit failure
	DIP-switches	Located behind front door, four pole dip switch to activate the internal bus terminator on the associated output
Power supply	External supply	24 VDC ... 32 VDC ± 10%, e.g. from SFC252/SFC260
	Power consumption	45 W, depending upon load
	Galvanic isolation	Mutual isolation >500 Vrms between input signal, internal output and external output
	Fuse	2.5 A time-lag
Certificates and Approvals	CE Mark	In attaching the CE Mark to a module, Endress+Hauser confirms that it conforms to the relevant EU directives.

6 Input Modules

6.1 SFC411 discrete input

Front view

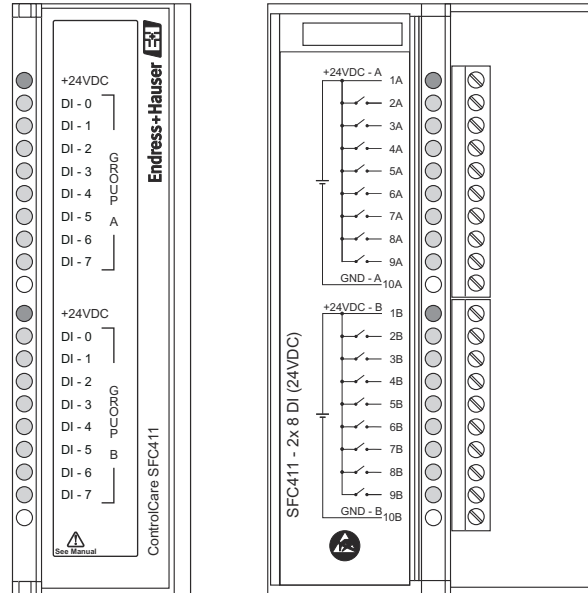

Fig. 6-1: SFC411 DC discrete input module, front panel and connection compartment

Description

The module senses the DC input voltage and converts it into a True (ON) or False (OFF) logic signal. It has 2 optically isolated groups. The green LED lights when the external power is connected, the yellow LEDs indicate the state "TRUE" at a particular input point. The principle switching data are as follows:

Property	SFC411
Architecture	<ul style="list-style-type: none"> ■ No. of inputs: 16 ■ No. of groups: 2 ■ No. of points/group: 8
External power	18 – 30 VDC
ON state level (True logic)	18 – 30 VDC
OFF state level (False logic)	0 – 5 VDC
Typical impedance	3900 Ω
Input current per point	typically 7.5 mA per point
Switching time (electrical)	<ul style="list-style-type: none"> ■ Time from "0" to "1": 30 μs ■ Time from "1" to "0": 50 μs

Technical data

Item	Property	Specification
Function	Designated use	16x DC discrete input module (24 VDC)
Input	No. of points	16, two groups of eight points each
	ON State Level (True Logic)	15 - 30 VDC, switches from 0 to 1 on leaving OFF state level
	OFF State Level (False Logic)	0 - 5 VDC, switches from 1 to 0 on leaving ON state level
	Typical Impedance	3900 Ω
	Input current per point	7.5 mA (typical)
	Switching time (electrical)	<ul style="list-style-type: none"> ■ Time from "0" to "1": 30 μs ■ Time from "1" to "0": 50 μs
Operating Conditions	Environment	See Section 2.5
Mechanical Construction	Design	See Section 2.6
	Weight	0.335 kg
	Terminal blocks	<ul style="list-style-type: none"> ■ Screw terminals: one wire 2 mm² (14 AWG) two wires 0.5 mm² (20 AWG)
Operability	Configuration	Via ControlCare Application Designer Suite
	LED indicators	<ul style="list-style-type: none"> ■ +24VDC: Green LED indicating presence of source voltage ■ DI 0...7: Yellow LEDs indicating input point in "TRUE" state
Power supply	External supply	Voltage source for inputs 18 - 30 VDC
	External current	65 mA per group
	Internal power	5 VDC @ 80 mA maximum supplied over backplane
	Power consumption	0.4 W
	Galvanic isolation	Individual isolation > 500 Vrms of groups
Certificates and Approvals	CE Mark	In attaching the CE Mark to a module, Endress+Hauser confirms that it conforms to the relevant EU directives.

6.2 SFC415 DC discrete input - sink

Front view

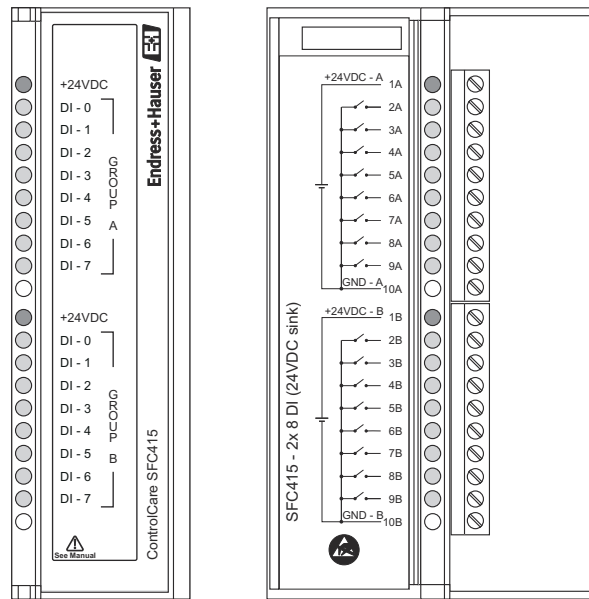

Fig. 6-2: SFC415 DC discrete input module, front panel and connection compartment

Description

The module senses the DC input voltage and converts it into a True (ON) or False (OFF) logic signal. It has 2 optically isolated groups of 8 inputs. The green LED lights when the external power is connected, the yellow LEDs indicate the state "TRUE" at a particular input point. The principle switching data are as follows:

Property	SFC415
Architecture	<ul style="list-style-type: none"> ■ No. of inputs: 16 ■ No. of groups: 2 ■ No. of points/group: 8
External power	20 – 30 VDC
ON state level (True logic)	0 – 5 VDC, < 200 Ω
OFF state level (False logic)	20 – 30 VDC, > 10 k Ω
Typical impedance	3900 Ω
Input current per point	typically 7.5 mA per point
Switching time (electrical)	<ul style="list-style-type: none"> ■ Time from "0" to "1": 30 μs ■ Time from "1" to "0": 50 μs

Technical data

Item	Property	Specification
Function	Designated use	16x DC discrete input module - sink (24 VDC)
Input	No. of points	16, two groups of eight points each
	ON State Level (True Logic)	0 - 5 V, < 200 Ω , switches from 0 to 1 on leaving OFF state level
	OFF State Level (False Logic)	20 - 30 V, >10 k Ω , switches from 1 to 0 on leaving ON state level
	Typical Impedance	3900 Ω
	Input current per point	7.5 mA (typical)
	Switching time (electrical)	<ul style="list-style-type: none"> ■ Time from "0" to "1": 30 μs ■ Time from "1" to "0": 50 μs
Operating Conditions	Environment	See Section 2.5
Mechanical Construction	Design	See Section 2.6
	Weight	0.350 kg
	Terminal blocks	<ul style="list-style-type: none"> ■ Screw terminals: one wire 2 mm² (14 AWG) two wires 0.5 mm² (20 AWG)
Operability	Configuration	Via ControlCare Application Designer Suite
	LED indicators	<ul style="list-style-type: none"> ■ +24VDC: Green LED indicating presence of source voltage ■ DI 0...7: Yellow LEDs indicating input point in "TRUE" state
Power supply	External supply	Voltage source 20 - 30 VDC
	External current	65 mA per group
	Internal power	5 VDC @ 80 mA maximum supplied over backplane
	Power consumption	0.4 W
	Galvanic isolation	Mutual isolation > 500 Vrms between groups
Certificates and Approvals	CE Mark	In attaching the CE Mark to a module, Endress+Hauser confirms that it conforms to the relevant EU directives.

6.3 SFC420 switch input

Front view

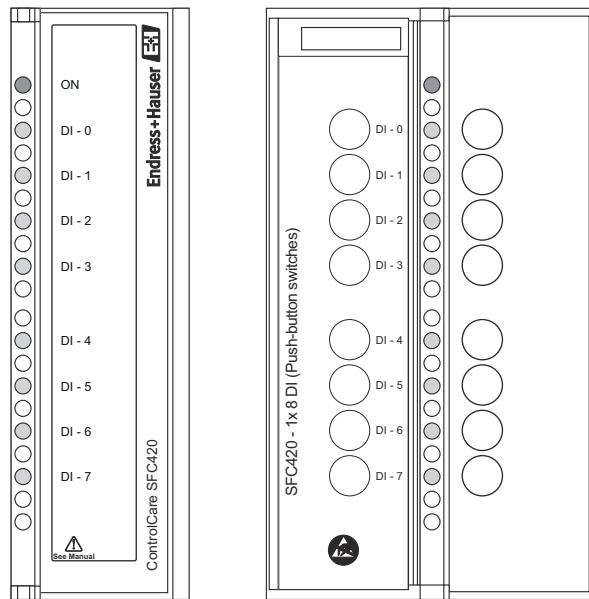

Fig. 6-3: SFC420 switch input module, front panel and connection compartment

Description

The module simulates 8 discrete inputs through the use of pushbutton switches. It can also be used as a set of regular keys. The pushbuttons can be used to interact with the logic of the program or in the "debugging" process for verification of functionality and optimization.

Technical data

Item	Property	Specification
Function	Designated use	8x switch input module
Input	No. of points	8
	ON State Level (True Logic)	Switch latched (= ON)
	OFF State Level (False Logic)	Switches unlatched (= OFF)
Operating Conditions	Environment	See Section 2.5
Mechanical Construction	Design	See Section 2.6
	Weight	0.285 kg
	Terminal blocks	<ul style="list-style-type: none"> ■ Screw terminals: one wire 2 mm² (14 AWG) two wires 0.5 mm² (20 AWG)
Operability	Configuration	Via ControlCare Application Designer Suite
	Switches	8 on/off pushbutton switches
	LED indicators	<ul style="list-style-type: none"> ■ ON: Green LED indicating presence of backplane voltage ■ DI 0...7: Yellow LEDs indicating input point in "TRUE" state
Power supply	Internal power	5 VDC @ 45mA maximum supplied over backplane
	Power consumption	0.225 W
Certificates and Approvals	CE Mark	In attaching the CE Mark to a module, Endress+Hauser confirms that it conforms to the relevant EU directives.

6.4 SFC444, SFC457 analog input

The following analog input modules are available:

- SFC444 (8x Voltage/Current Analog Inputs with Internal Shunt Resistor)
- SFC457 (8x Differential Voltage/Current Analog Inputs with Internal Shunt Resistor)

Front view

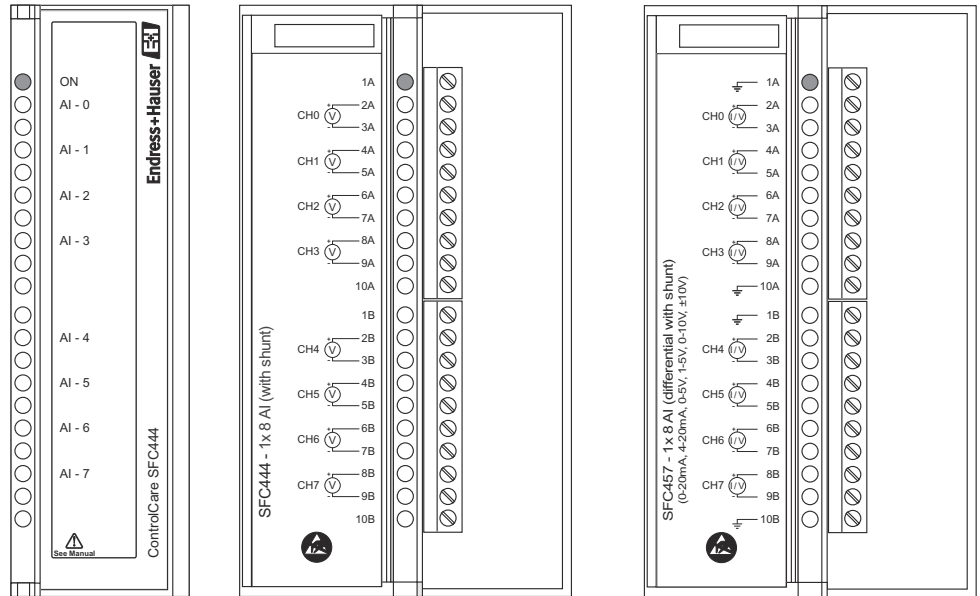

Fig. 6-4: SFC444/SFC457 analog input modules, front panel (SFC444) and connection compartments

Description

These modules read 8x voltage or 8x current analog signals. The inputs are isolated from the backplane power supply. Module SFC457 has differential inputs (no common ground) only. The factory setting is for current and can be changed for each channel with a jumper on the card.

Module	Description
SFC444	The inputs are individually configured in ControlCare Application Designer* to read: <ul style="list-style-type: none"> ■ $\pm 10\text{ V}$; $\pm 5\text{ V}$; 0-5 V or 1-5 V with the internal shunt resistor ($250\ \Omega/0,05\%$) in position "V". ■ $\pm 40\text{ mA}$; $\pm 20\text{ mA}$; 0-20 mA, 4-20 mA, with the internal shunt resistor in position "I".
SFC457	The inputs are differential (no common ground) and are individually configured in ControlCare Application Designer* to read: <ul style="list-style-type: none"> ■ $\pm 10\text{ V}$; $\pm 5\text{ V}$; 0-5 V or 1-5 V with the internal shunt resistor ($250\ \Omega/0,05\%$) in position "V". ■ $\pm 40\text{ mA}$; $\pm 20\text{ mA}$; 0-20 mA, 4-20 mA, with the internal shunt resistor in position "I".

*With XD_SCALE parameter in AI block; for the MAI block the input range 4 mA to 20 mA/1 V to 5 V (depending on jumper) gives an output of 0 to 100%. Other input ranges produce a proportional change in output range, e.g 0 mA gives -25%.

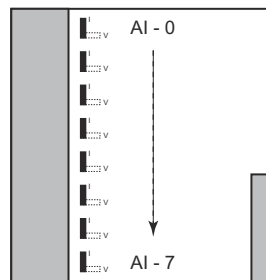

Fig. 6-5: Position of jumpers for current/voltage configuration

Technical data

Item	Property	Specification
Function	Designated use	8x analog input modules with various input versions
Input	No. of points	8 inputs in one group
	Measuring range	<ul style="list-style-type: none"> ■ SFC444, SFC457: 0-20 mA, 4-20 mA, 0-5 V, 1-5 V, 0-10 V, ± 10 V
	Typical Impedance	<ul style="list-style-type: none"> ■ SFC444, SFC457: 1000 Ω for voltage input, 250 Ω for current input
	A/D conversion	<ul style="list-style-type: none"> ■ Conversion time: 20 ms ■ Resolution: 16 bits for ± 10 V/± 40 mA 15 bits for 0-10V/0-40 mA 14 bits for 0-5V/0-20 mA 13.6 bits for 1-5V/4-20 mA
Operating Conditions	Environment	See Section 2.5
	Accuracy at 25 °C	Range: 0-5 V, 1-5 V, 0-10 V Range: 0-20 mA, 4-20 mA <ul style="list-style-type: none"> ■ SFC443: ± 0.1% of span (Linearity/Interference) ■ SFC444: ± 0.12% of span (Linearity/Interference) Range: ± 10 V <ul style="list-style-type: none"> ■ All modules: ± 0.2% of span (Linearity/Interference)
	Ambient temperature effect	Range: 0-20 mA, 4-20 mA, 0-5V, 1-5 V, 0-10 V <ul style="list-style-type: none"> ■ ± 0.2% of span /77 ° F (25° C) Range: ± 10 V <ul style="list-style-type: none"> ■ ± 0.1% of span /77 ° F (25° C)
Mechanical Construction	Design	See Section 2.6
	Weight	0.330 kg
	Terminal blocks	<ul style="list-style-type: none"> ■ Screw terminals: one wire 2 mm² (14 AWG) two wires 0.5 mm² (20 AWG)
Operability	Configuration	Input range via ControlCare Application Designer Suite Input type (I or V) via jumpers on card
	LED indicators	<ul style="list-style-type: none"> ■ ON: Green LED indicating presence of source voltage
Power supply	Internal power	5 VDC @ 350 mA maximum supplied over backplane
	Power consumption	1.75 W
	Galvanic isolation	Isolation > 500 Vrms between channel and backplane bus
Certificates and Approvals	CE Mark	In attaching the CE Mark to a module, Endress+Hauser confirms that it conforms to the relevant EU directives.

Note!

- Use shielded cables for inputs, grounded at one end only (to cabinet ground)



6.5 SFC445 temperature input

Front view

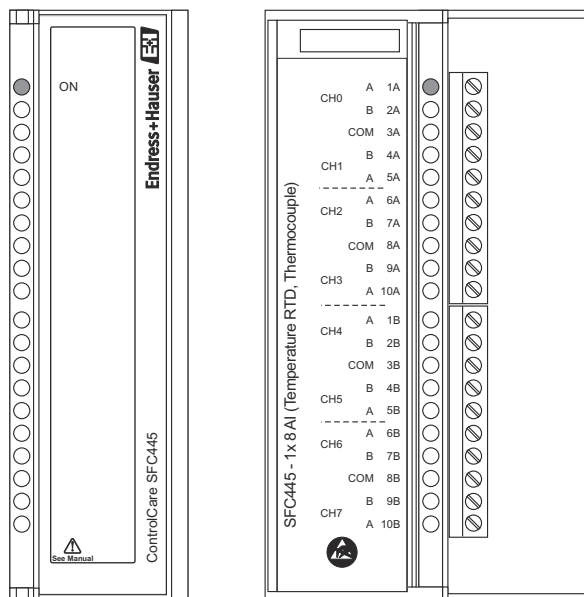

Fig. 6-6: SFC445 temperature input module, front panel and connection compartment

Description

This module is able to measure temperature from a large variety of thermocouples (TC) and RTD's as well as millivolts and resistance with high accuracy.

Temperature measurements are linearized internally. In the case of thermocouples a cold junction compensation is already built-in close to the terminals of the module.

Technical data

Item	Property	Specification
Function	Designated use	8x temperature input
Input	No. of points	8 inputs in one group
	Sensor type	<ul style="list-style-type: none"> ■ RTD: Cu10 (GE); Ni120 (Edison Curve#7), Pt50, Pt100, Pt500 (IEC), Pt50 and Pt100 (JIS); ■ TC: B, E, J, K, N, R, S, T, L and U (DIN) ■ Voltage: -50 to 500 mV; ■ Resistance: 0 - 2000 Ohms
	Measuring range	Depends on sensor
	Typical Impedance	1 MΩ
	A/D conversion	<ul style="list-style-type: none"> ■ Conversion time: 90 ms per channel ■ Resolution: 16 bits
Operating Conditions	Environment	See Section 2.5
	Accuracy at 25 °C	± 0.05% of maximum span
	Ambient temperature effect	± 0.1% of span /77 ° F (25° C)
Mechanical Construction	Design	See Section 2.6
	Weight	0.325 kg
	Terminal blocks	<ul style="list-style-type: none"> ■ Screw terminals: one wire 2 mm² (14 AWG) two wires 0.5 mm² (20 AWG)
Operability	Configuration	Via ControlCare Application Designer Suite
	LED indicators	<ul style="list-style-type: none"> ■ ON: Green LED indicating unit operating
Power supply	Internal power	5 VDC @ 35 mA maximum during operation 5 VDC @ 55 mA maximum during configuration supplied over backplane
	Power consumption	0.175 W during operation 0.275 W during configuration
	Galvanic isolation	Isolation > 500 Vrms between channel and backplane bus
Certificates and Approvals	CE Mark	In attaching the CE Mark to a module, Endress+Hauser confirms that it conforms to the relevant EU directives.

6.6 SFC441, SFC442, SFC467 pulse input

The following pulse input modules are available

- SFC441 (2 Groups of 8 inputs of 24 VDC for low speed pulse counting - sink)
- SFC442 (2 Groups of 8 inputs of 24 VDC for high speed pulse counting - sink)
- SFC467 (2 Groups of 8 inputs of 24 VAC for high speed pulse counting - sink)

Front view

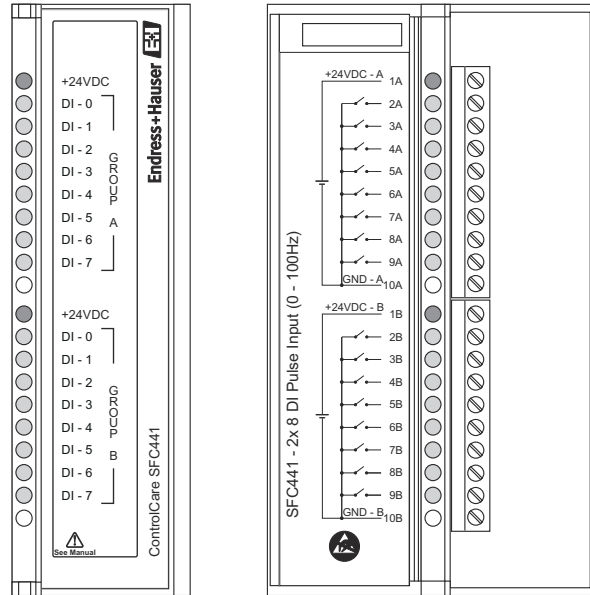

Fig. 6-7: SFC441 pulse input module, front panel and connection compartment

Description

The modules have 2 groups of 8 inputs to count and accumulate pulses until the Field Controller reads them. Immediately after it is read, every individual counter is cleared and the hardware begins to count again, ensuring that no pulses are lost during the acquisition process. An associated PULSE Function Block has been specifically designed to take advantage of this module. For details see the Function Block manual.

- SFC441 can be driven by a mechanical contact of a relay or reed-switch. A single pole internal filter has the cutting frequency in approximately 200 Hz.
- SFC442 is for higher frequency sources that do not generate bouncing on level switching.
- SFC467 is for higher frequency AC sources

Property	SFC441	SFC442	SFC467
Architecture	<ul style="list-style-type: none"> ■ No. of inputs: 16 ■ No. of groups: 2 ■ No. of points/group: 8 		
External power	20 – 30 VDC		
ON state level (True logic)	0– 5 VDC, < 200 Ω		–30 to –1.5 VAC
OFF state level (False logic)	20 – 30 VDC, > 10 k Ω		+1.5 to +30 VAC
Typical impedance	3900 Ω		
Input current per point	typically 7.5 mA		
Max. input frequency	0 to 100 Hz	0 to 10 kHz	0 to 10 kHz

Technical data

Item	Property	Specification
Function	Designated use	16x DC pulse input module
Input	No. of points	16, two groups of eight points each
	ON State Level (True Logic)	<ul style="list-style-type: none"> ■ SFC441, SFC442: 0 V to 5 V, < 200 Ω ■ SFC467: -30 V to -1.5 V Switches from 0 to 1 on leaving OFF state level
	OFF State Level (False Logic)	<ul style="list-style-type: none"> ■ SFC441, SFC442: 20 V - 30 V, >10 kΩ ■ SFC467: +1.5 V to +30 V Switches from 1 to 0 on leaving ON state level
	Typical Impedance	3900 Ω
	Input current per point	■ SFC441, SFC442: 6.5 mA (typical)
	Max. input frequency	<ul style="list-style-type: none"> ■ SFC441: 0 to 100 Hz ■ SFC442: 0 to 10 kHz ■ SFC467: 0 to 10 kHz, AC source
	No. of pulses before overflow	4096
	Min. overflow time	<ul style="list-style-type: none"> ■ SFC441: 40.96 s* ■ SFC442: 0.4096 s* ■ SFC467: 0.4096 s* *Macrocycle time must not exceed overflow time
Operating Conditions	Environment	See Section 2.5
Mechanical Construction	Design	See Section 2.6
	Weight	0.350 kg
	Terminal blocks	<ul style="list-style-type: none"> ■ Screw terminals: one wire 2 mm² (14 AWG) two wires 0.5 mm² (20 AWG)
Operability	Configuration	Via ControlCare Application Designer Suite
	LED indicators	<ul style="list-style-type: none"> ■ +24VDC: Green LED indicating presence of source voltage ■ DI 0...7: Yellow LEDs indicating input point in "TRUE" state
Power supply	External supply	Voltage source 20 - 30 VDC
	Typical external current	<ul style="list-style-type: none"> ■ SFC441, SFC442: 65 mA per group @ 24 VDC ■ SFC467: 12 mA per group @ 24 VDC
	Internal power	<ul style="list-style-type: none"> ■ SFC441: 5 VDC @ max. 90 mA ■ SFC442, SFC467: 5 VDC @ max. 130 mA supplied over backplane
	Power consumption	<ul style="list-style-type: none"> ■ SFC441: 0.425 W ■ SFC442, SFC467: 0.650 W
	Galvanic isolation	Individual isolation > 500 Vrms for groups
Certificates and Approvals	CE Mark	In attaching the CE Mark to a module, Endress+Hauser confirms that it conforms to the relevant EU directives.

7 Output Modules

7.1 SFC428 high density NO relay output

Front view

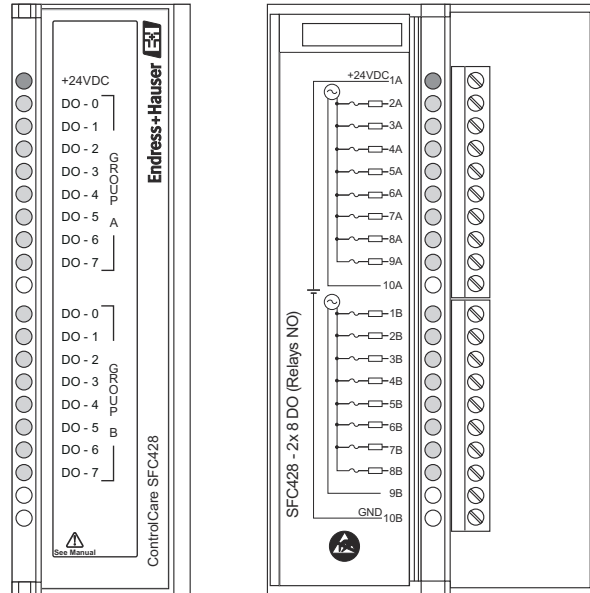

Fig. 7-1: SFC428 high density relay output module, front panel and connection diagram

Description

The module is designed to switch pilot lamps, valves, as well as relay coils and supplies up to 5 A per output.

Note!



- To increase contact life and protect the module from potential reverse voltage damage, connect an external clamping diode in parallel with each inductive DC load or a RC snubber circuit in parallel with each inductive AC load

Property	SFC428
Architecture	<ul style="list-style-type: none"> ■ No. of inputs: 16 ■ No. of groups: 2 ■ No. of points/group: 8
External power per group	20 - 30 VDC
Output voltage range	0 - 30 VAC; 0 - 30 VDC
Max. current per output	<ul style="list-style-type: none"> ■ 30 VAC: 5 A (resistive); 2 A (inductive) ■ 30 VDC: 5 A (resistive); 2 A (inductive)
Initial contact resistance	Max. 100 mΩ
Switching time (electrical)	<ul style="list-style-type: none"> ■ Activation: max. 10 ms ■ De-activation: max. 10 ms

Technical data

Item	Property	Specification
Function	Designated use	16x DO relay output module (NO)
Output	No. of points	16, two groups of eight points
	Output voltage rating	0 - 30 VAC; 0 - 30 VDC
	Max. current per output	<ul style="list-style-type: none"> ■ 30 VAC: 5 A (resistive); 2 A (inductive) ■ 30 VDC: 5 A (resistive); 2 A (inductive)
	Max. initial contact resistance	100 mΩ
	Max. total current per group	10 A
	Switching time	<ul style="list-style-type: none"> ■ Activation: Max. 10 ms ■ Deactivation: Max. 10 ms
	Switching information	■ RC protection circuit 62 Ω in series with 0.01 μF
	Overload protection	Should be provided externally
	Electrical service life	100.000 operations minimum @ 5 A, 30 VAC
Operating Conditions	Environment	See Section 2.5
Mechanical Construction	Design	See Section 2.6
	Weight	0.365 kg
	Terminal blocks	<ul style="list-style-type: none"> ■ Screw terminals: one wire 2 mm² (14 AWG) two wires 0.5 mm² (20 AWG)
Operability	Configuration	Via ControlCare Application Designer Suite
	LED indicators	<ul style="list-style-type: none"> ■ +24VDC : Green LED indicating presence of backplane voltage ■ DO 0...7: Yellow LEDs lit when output active
Power supply	External supply	Voltage source per group 20 - 30 VDC
	Max. current per group	90 mA @ 24 VDC
	Max. consumption per point	11.3 mA @ 24 VDC
	Internal power	5 VDC @ 30 mA maximum supplied over backplane
	Power consumption	0.15W + 0.54 W
	Galvanic isolation	Optical isolation > 500 Vrms between relay drivers and backplane bus Each group of 8 relays has one common contact
	Protection	One fuse per group
Certificates and Approvals	CE Mark	In attaching the CE Mark to a module, Endress+Hauser confirms that it conforms to the relevant EU directives.

7.2 SFC446 current and voltage output

Front view

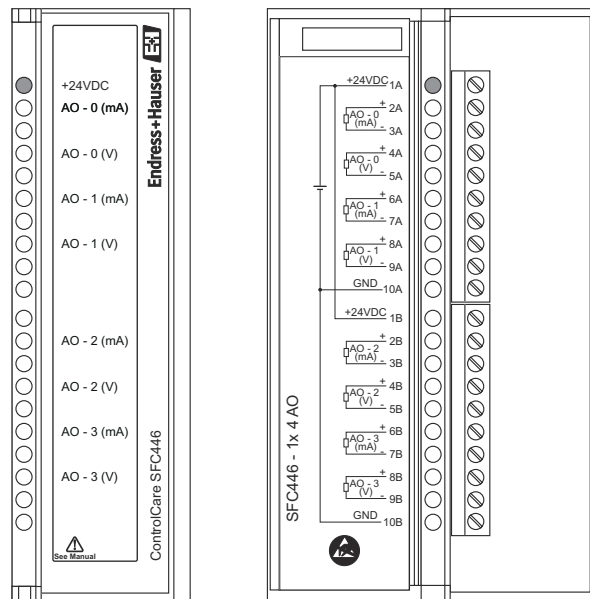

Fig. 7-2: SFC446 current and voltage analog output module, front panel and connection compartment

Description

The module provides 4 analog outputs that can be wired as either current or voltage signals. The current outputs can be individually configured with Application Designer to ranges of 0-20 mA or 4-20 mA. Voltage output ranges are as follows: ± 10 V, 0 -10 V, ± 5 V, 0 - 5 V and 1 - 5 V. When used in voltage mode, the range end value must be configured via the DIP-switches located within the casing at the top and bottom of the module. These can be accessed externally with a small screw driver or other pointed object.

Switch	Location	Use
DIP-switch 1	Top side	Configures the range end value of Channel AO-0 (5V/10V)
DIP-switch 2	Top side	Configures the range end value of Channel AO-1 (5V/10V)
DIP-switch 1	Bottom side	Configures the range end value of Channel AO-2 (5V/10V)
DIP-switch 2	Bottom side	Configures the range end value of Channel AO-3 (5V/10V)

The switching data is as follows:

Property	SFC446
Architecture	No. of inputs: 4, No. of groups: 1
External power	20 – 30 VDC
Voltage ranges*	DIP-switch off: 1 V to 5 V, 0 to 5 V, -5 V to 5 V DIP-switch on: 2 V to 10 V, 0 to 10 V, -10 V to 10 V
Current ranges*	4 to 20 mA, 0 to 20 mA
*Configured in ControlCare Application Designer	
– With XD_SCALE parameter in AI block	
– For the MAI block the input range 0 to 100% corresponds to an output range of 4 mA to 20 mA or 1 V to 5 V/2 to 20 V (depending on jumper). Other input ranges produce a proportional change in output range, e.g. -25% corresponds to 0 mA/0 V, -225 to -5V/-10V	

Technical data

Item	Property	Specification
Function	Designated use	Field Controller 4x current or voltage output module
Output	No. of points	1 group of 4 points
	Output range	<ul style="list-style-type: none"> ■ Current: 4 - 20 mA, 0 - 20 mA ■ Voltage (OFF): 1 - 5 V, 0 - 5 V, -5 - +5 V ■ Voltage (ON): 2 - 10 V, 0 - 10 V, -10 - +10 V
	Output type	Single ended (1 common)
	Load impedance	<ul style="list-style-type: none"> ■ 5 V: 2 kΩ minimum ■ 10 V: 5 kΩ minimum ■ 20 mA: 750 Ω maximum
	A/D conversion	<ul style="list-style-type: none"> ■ Conversion speed: 8 ms ■ Resolution: 12 bits
Operating Conditions	Environment	See Section 2.5
	Accuracy at 77 ° F (25 ° C)	\pm 0.5% of span
Mechanical Construction	Design	See Section 2.6
	Weight	0.405 kg
	Terminal blocks	<ul style="list-style-type: none"> ■ Screw terminals: one wire 2 mm² (14 AWG) two wires 0.5 mm² (20 AWG)
Operability	Configuration	Via ControlCare Application Designer Suite
	LED indicators	<ul style="list-style-type: none"> ■ +24VDC: Green LED indicating presence of external voltage
	DIP switches	<p>Four DIP switches at top and bottom of module controlling voltage settings:</p> <ul style="list-style-type: none"> ■ DIP switch OFF: Voltage range 1 - 5 V etc. ■ DIP switch ON: Voltage range 2 - 10 V etc.
Power supply	External supply	Voltage source 20 - 30 VDC
	Max. current	180 mA
	Internal power	5 VDC @ 20 mA maximum supplied over backplane
	Power consumption	0.1 W + 0.54 W
	Galvanic isolation	Isolation > 500 Vrms between channel and bus and between channel and external supply
Certificates and Approvals	CE Mark	In attaching the CE Mark to a module, Endress+Hauser confirms that it conforms to the relevant EU directives.

8 Combined I/O Modules

8.1 SFC432, SFC435, SFC438 voltage input and relay output

The following combined input and output modules are available:

- SFC432(1 group of 8 24 VDC inputs and 1 group of 4 NO relays)
- SFC435(1 group of 8 24 VDC inputs and 1 group of 4 NC relays)
- SFC438(1 group of 8 24 VDC inputs and 1 group of 2 NO and 2 NC relays)

Front view

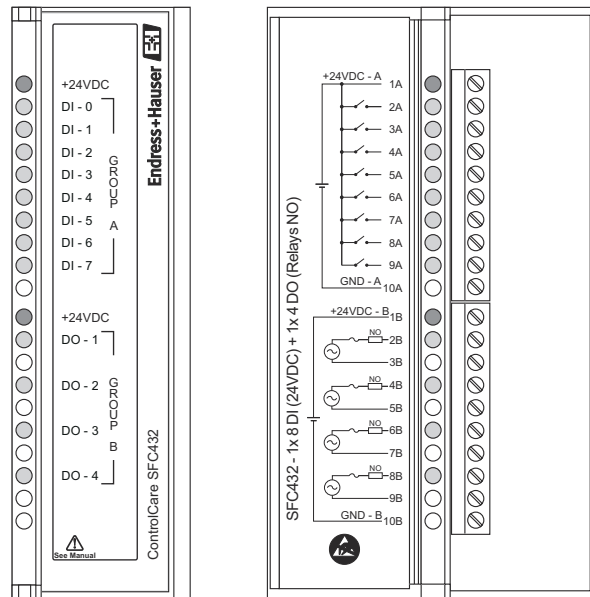

Fig. 8-1: SFC432 DC input and relay output module, front panel and connection compartment

Description

The modules with combined DC Inputs and Relay Outputs are designed to drive relays, pilot lamps, valves and other loads up to 5 A. The module senses the DC input voltage and converts it to a true or false logic signal.

Each module has 1 group of 8 optically isolated 24 VDC inputs and 4 relay outputs, see above. The relays can drive loads ranging from 0 to 30 VDC or from 0 to 30 VAC. Two screw terminals are reserved for each relay output, which are mutually isolated from each other.

Note!



- To increase relay contact life and protect the module from potential reverse voltage damage, connect an external clamping diode in parallel with each inductive DC load or a RC snubber circuit in parallel with each inductive AC load

Technical data

Item	Property	Specification
Function	Designated use	8x DC discrete input and 4x relay output module in 3 output type versions
Input	No. of points	8, one group of eight points each
	ON State Level (True Logic)	15 - 30 VDC, switches from 0 to 1 on leaving OFF state level
	OFF State Level (False Logic)	0 - 5 VDC, switches from 1 to 0 on leaving ON state level
	Typical Impedance	3900 Ω
	Input current per point	7.5 mA (typical)
	Switching time (electrical)	<ul style="list-style-type: none"> ■ Time from "0" to "1": 18 ms ■ Time from "1" to "0": 40 ms
Output	No. of points	8, two groups of four points
	Type	<ul style="list-style-type: none"> ■ SFC432: NO relays ■ SFC435: NC relays ■ SFC438: NO and NC relays
	Output voltage rating	0 - 30 VAC; 0 - 30 VDC
	Max. current per output	<ul style="list-style-type: none"> ■ 30 VAC: 5 A ■ 30 VDC: 5 A
	Max. initial contact resistance	30 m Ω
	Leakage	500 mA @ 100 VAC
	Switching time (electrical)	<ul style="list-style-type: none"> ■ Activation: Max. 10 ms ■ Deactivation: Max. 10 ms
	Switching information	■ RC protection circuit 62 Ω in series with 0.01 μ F
	Overload protection	Should be provided externally
	Electrical service life	100.000 operations minimum @ 5 A, 30 VAC
Operating Conditions	Environment	See Section 2.5
Mechanical Construction	Design	See Section 2.6
	Weight	0.350 kg
	Terminal blocks	<ul style="list-style-type: none"> ■ Screw terminals: one wire 2 mm² (14 AWG) two wires 0.5 mm² (20 AWG)
Operability	Configuration	Via ControlCare Application Designer Suite
	LED indicators	<ul style="list-style-type: none"> ■ +24VDC: Green LED indicating presence of source voltage ■ 0...7: Yellow LEDs indicating input point in "TRUE" state ■ 0...3: Yellow LEDs indicating output point activated
Power supply	External supply	Voltage source for inputs 18 - 30 VDC
	External current	67 mA per group, max. 16.8 mA per point
	Internal power (relay)	5 VDC @ 60 mA maximum supplied over backplane
	Power consumption	0.3 W + 0.4 W
	Galvanic isolation	Isolation > 500 Vrms <ul style="list-style-type: none"> ■ Groups individually isolated ■ 8 Relay contacts individually isolated, each with two dedicated terminals ■ The power supply for the groups Individually isolated ■ Optical isolation between relay drivers and backplane bus
Certificates and Approvals	CE Mark	In attaching the CE Mark, Endress+Hauser confirms that the devices conform to all relevant EU directives.

9 Accessories

Code	Designation	Remarks
SFC900	Housing, empty slot	
SFC901A	Rack assembly with 4-slot backplane	For Field Controllers and local I/O modules
SFC902	Rack terminator	
SFC903	Connection cable, 65 mm	
SFC904A	Connection cable, 651 mm	
SFC905A	Connection cable, 814 mm	
SFC906A	Connection cable, 977 mm	
SFC907A	Connection cable, 1140 mm	
SFC909	Stand-alone base for 1 module	Only for mounting SFC252 or SFC353
SFC910	Rack assembly with 2-slot backplane	For SFC050/SFC056 and SFC173 as first rack assembly in rack
SFC954	Ethernet cable, 100BaseT, 2m	Standard, with RJ-45 connector, plastic
SFC955	Ethernet cable, 100BaseT, 2m	Cross, with RJ-45 connector, plastic

10 Rack power requirement

It is important to calculate the power consumption of the modules in the rack in order to determine how many power supplies are required to satisfy the demand and how they are to be distributed. There are three basic design principles:

- A power supply feeds the modules located on its right-hand side
- One power supply may feed no more than three racks
- The power demand in each "power segment" may not exceed the output of the power supply

Note!



- The Fieldbus Power Supplies SFC252 and SFC260 are not included in this calculation because they have their own external AC or DC power supply.
- For large rack assemblies it is recommended that the 24 VDC power demand is supplied by an external power supply

The examples overleaf show you how to calculate the power demand.

Procedure

- 1 In the Power Demand Sheet overleaf, note the quantity of modules of each type you need.
- 2 Now multiply the maximum current values to obtain the 24 VDC and 5 VDC power demand for each type of module.
- 3 Add up the current consumption of the modules you require for your system.
- 4 Devide the total current consumption by the maximum current output of the power supply module you intend to use, to determine how many power supply units you require.
- 5 Provisionally assign the modules to "power segments", taking into account that one power supply may feed no more than three racks.
- 6 Now check that the power requirement of each "power segment" does not exceed 90% of the maximum current supplied by the power module.
 - If this is the case, we recommend that you reassign the modules in the power segments or add an additional power supply.

Power demand sheet

Module	Description	Qty	Current consumption			
			Unit current (mA)		Total current (mA)	
			Ext. @24 VDC	Rack @5 VDC	Ext. @24 VDC	Rack @5 VDC
SFC162	Field Controller (FF)		0	700		
SFC173	Field Controller (PROFIBUS)		0	700		
SFC353	Fieldbus power conditioner NIS (340 mA per channel)		1500	0		
SFC411	2x8 DI (24 VDC) ¹⁾		130	80		
SFC415	2x8 DI (24 VDC sink) ¹⁾		130	80		
SFC420	1x8 DI (on/off switches)		0	45		
SFC428	2x8 DO (Relay NO)		180	30		
SFC432	1x8 DI (24 VDC) + 1x4 DO (Relay NO) ²⁾		132	60		
SFC435	1x8 DI (24 VDC) + 1x4 DO (Relay NC) ²⁾		132	60		
SFC438	1x8 DI (24 VDC) + 1x2+2 DO (Relay NO/NC) ²⁾		132	60		
SFC441	2x8 DI (Impulse 100 Hz)		130	90		
SFC442	2x8 DI (Impulse 10 kHz)		130	130		
SFC444	1x8 AI (with shunt)		0	350		
SFC445	1x8 AI (Temperature RTD, Thermocouple)		0	55		
SFC446	2x4 AO		180	20		
SFC457	1x8 AI (differential with shunt)		0	350		
SFC467	2x8 DI (Impulse AC)		25	130		
Total current demand						
+° 20% tolerance						
Design current demand						
¹⁾ 65 mA per group, ²⁾ Inputs 65 mA, relays 67 mA						

Power supply sheet

Module	Description	Qty	Provision			
			Unit current (mA)		Total current (mA)	
			Ext. @24 VDC	Rack @5 VDC	Ext. @24 VDC	Rack @5 VDC
SFC050	AC Backplane power supply		300	3000		
SFC056	DC Backplane power supply		300	3000		
SFC252	AC Fieldbus power supply		1500			
SFC260	DC Fieldbus power supply		800			
Total current supplied						

Example

The system comprises SFC162, SFC252, SFC353, 2x SFC415 and 2x SFC446. Two FF H1 channels are in operation. The power consumption of the fieldbus is:

Module	Description	No. H1 channels	Demand/channel	External @24 VDC
SFC353	Fieldbus power conditioner NIS	2	340 mA	780 mA

The external 24 VDC requirement for the SFC363 power conditioner is covered by one SFC252 or SFC260 module.

The power consumption of the local I/O is:

Module	Description	Qty	Consumption				
			Unit power (mA)		Total power (mA)		
			Ext. @24 VDC	Rack @5 VDC	Ext. @24 VDC	Rack @5 VDC	
SFC162	Field Controller	1	0	700	0	700	
SFC415	2x8 DI (240 VAC)	2	130	80	260	160	
SFC446	1x4 AO	2	180	20	360	40	
Total current demand						620	900
+ 20% tolerance						134	180
Design current demand						754	1080

The result shows that, allowing for 20% tolerance, the 5 VDC backplane power demand is covered by one SFC050 or SFC056 module. The 24 VDC supply for the I/O would require two extra power supplies, so a standard 24 VDC power pack is recommended. The rack can be arranged as follows (for a system with non-redundant power supply):

**Rack arrangement
SFC901A**

Rack No.	Slot 0	Slot 1	Slot 2	Slot 3
0	SFC050	SFC162	SFC252	SFC353
1	SFC415	SFC415	SFC446	SFC446

Note:

- The Field Controller may not be located in Slot 2 or 3
- The I/O modules may not be positioned in the rack assembly with address "0"
- SFC252 and SFC353 are required for FOUNDATION Fieldbus applications only

**Rack arrangement
SFC910 plus SFC901A**

If the SFC173 is used for the same application, the SFC353 and SFC252 or SFC260 are not required. The power demand for the I/O remains the same, so an external 24 VDC supply unit is recommended.

Rack No.	Slot 0	Slot 1	Slot 2	Slot 3
0 (SFC910)	SFC050	SFC173	N/A	N/A
1 (SFC901A)	SFC415	SFC415	SFC446	SFC446

Note:

- It is possible to use the SCF252 as external power supply (3000 mA). It can be mounted in Slot 0 or 2 of a SFC901A rack assembly or separately on a SFC909 stand-alone base.

For your notes

For your notes

Index

A

Accessories 38

C

Combined I/O units 36

Commissioning 3

Control module

 FF Field Controller 10

 PROFIBUS Field Controller 12

D

Dimensions 6

Documentation 8

E

EMV 3

F

Field controller 10

G

General specification 4

I

I/O module

 Analog input 27

 Current and voltage output unit 34

 DC discrete input - sink 24

 Discrete input 22

 High density NO relay output 32

 Pulse input 30

 Switch input 26

 Temperature input 29

 Voltage input and relay output 36

Input modules 22

Installation 3

O

Operation 3

Output modules 32

P

Power demand 40

Power module

 AC backplane power supply 14

 DC backplane power supply 16

 Fieldbus power conditioner 20

 Fieldbus power supply 18

Power supplies 14

R

Rack power calculation 39

S

SFC 056 15

SFC050 14

SFC056 16

SFC162 10

SFC173 12

SFC252, SFC260 18

SFC353 20

SFC411 22

SFC415 24

SFC420 26

SFC428 32

SFC432, SFC435, SFC438 36

SFC441, SFC442, SFC467 30

SFC444, SFC457 27

SFC445 29

SFC446 34

W

Workstations 9

www.endress.com/worldwide

Endress+Hauser 
People for Process Automation
