



Level



Pressure



Flow



Temperature



Liquid
Analysis



Registration



Systems
Components



Services



Solutions

Safety Instructions

Proline Promag 50

HART, PROFIBUS DP/PA

Division 1

Ex documentation



Safety instructions for electrical apparatus for explosion-hazardous areas according to FACTORY MUTUAL standards → Page 3



Safety instructions for electrical apparatus for explosion-hazardous areas according to CANADIAN STANDARDS ASSOCIATION → Page 13

Examples for markings according to FM and CSA:



Temperature Class

	Maximum surface temperature	
T1	842 °F	450 °C
T2	572 °F	300 °C
T2A	536 °F	280 °C
T2B	500 °F	260 °C
T2C	446 °F	230 °C
T2D	419 °F	215 °C
T3	392 °F	200 °C
T3A	356 °F	180 °C
T3B	329 °F	165 °C
T3C	320 °F	160 °C
T4	275 °F	135 °C
T4A	248 °F	120 °C
T5	212 °F	100 °C
T6	185 °F	85 °C

FM APPROVALS

Type of Protection

Example: **XP / I / 1 / ABCD**

XP	Explosionproof
IS	Intrinsically Safe Apparatus
AIS	Associated Apparatus with Intrinsically Safe Connections
ANI	Associated Nonincendive Field Wiring Apparatus
PX,PY,PZ	Pressurized
APX,APY,APZ	Associated Pressurization Systems/Components
NI	Nonincendive
DIP	Dust-Ignitionproof
S	Special Protection

Class

I	Class I (Gas)
II	Class II (Dust)
III	Class III (Fibre)

Division

1	Division 1
2	Division 2

Group

FM /NEC	Gases, vapours and dust examples	Min. ignition temperature [µJ]
A	Acetylene, carbon disulfide (Class I)	0.02
B	Hydrogen, ethyl nitrate (Class I)	0.02
C	Ethylene, isoprene (Class I)	0.06
D	Acetone, ethane, benzene, ethanoic acid, gasolines, diesel oil, aircraft fuel, methane, heating oil,crude oil, hexane, ether (Class I)	0.18
E	Metallic powder (Class II)	
F	Coal dust (Class II)	
G	Mill dust (Class II)	
	Textile fibres (Class III)	



Temperature Class

	Maximum surface temperature	
T1	450 °C	842 °F
T2	300 °C	572 °F
T2A	280 °C	536 °F
T2B	260 °C	500 °F
T2C	230 °C	446 °F
T2D	215 °C	419 °F
T3	200 °C	392 °F
T3A	180 °C	356 °F
T3B	165 °C	329 °F
T3C	160 °C	320 °F
T4	135 °C	275 °F
T4A	120 °C	248 °F
T5	100 °C	212 °F
T6	85 °C	185 °F

Canadian Standards Association

Class

Example: **Class I, Division 1, Group ABCD**

I	Class I (Gas)
II	Class II (Dust)
III	Class III (Fibre)

Division

1	Division 1
2	Division 2

Group

CSC /NEC	Gases, vapours and dust examples	Min. ignition temperature [µJ]
A	Acetylene, carbon disulfide (Class I)	0.02
B	Hydrogen, ethyl nitrate (Class I)	0.02
C	Ethylene, isoprene (Class I)	0.06
D	Acetone, ethane, benzene (Class I)	0.18
E	Metallic powder (Class II)	
F	Coal dust (Class II)	
G	Mill dust (Class II)	
	Textile fibres (Class III)	

Type of Protection

Explosionproof
Intrinsically Safe Apparatus
Associated Apparatus with Intrinsically Safe Connections
Associated Nonincendive Field Wiring Apparatus
Pressurized
Associated Pressurization Systems/Components
Nonincendive
Dust-Ignitionproof
Special Protection



Level



Pressure



Flow



Temperature



Liquid
Analysis



Registration



Systems
Components



Services



Solutions

Safety Instructions

Proline Promag 50

HART, PROFIBUS DP/PA

Division 1



Ex documentation

This document is an integral part of the following Operating Instructions:

- BA046D, Proline Promag 50 HART
- BA055D, Proline Promag 50 PROFIBUS DP/PA

Table of Contents FM

Special conditions	4
General warnings	4
Approvals	4
Description of measuring system	5
Nameplate	5
Type code	6
Temperature table compact version	7
Design of measuring system	7
Cable entries	7
Cable specification	7
Potential equalization	7
Electrical connection	8
Terminal assignment and connection data, power supply	8
Terminal assignment and connection data for signal circuits (intrinsically safe circuits)	9
Terminal assignment and connection data for signal circuits (non-intrinsically safe circuits)	10
Service adapter	10
Device fuse	10
Technical Data	11
Control Drawings	11

Special conditions

- Install per National Electrical Code ANSI/NFPA 70.
 - Control room equipment shall not use or generate more than 250 V rms.
 - The device must be integrated into the potential equalization system.
 - For terminals No. 20 to No. 27 of the transmitter, only devices with ratings $U_m \leq 250$ V and $I_m \leq 500$ mA are allowed to be connected (does not apply to intrinsically safe circuits).
 - The specified temperature class in conjunction with the ambient temperature and the medium temperature must be in compliance with the tables on Page 7.
 - It is not permissible to connect the service adapter whilst the atmosphere is considered to be explosive.
 - Use of the devices is restricted to mediums against which the process-wetted materials are adequately resistant.
 - Transmitter enclosure is factory sealed for use in Class I, Div. 1, Groups A, B, C, D.
-  Caution!
- Use supply wires suitable for 9 °F above ambient temperature, but at least for 176 °F.

General warnings

- Installation, connection to the electricity supply, commissioning and maintenance of the devices must be carried out by qualified specialists trained to work on Ex-rated devices.
- Compliance with national regulations relating to the installation of devices in potentially explosive atmospheres is mandatory, if such regulations exist.
- Open the device only when it is de-energized (and after a delay of at least 10 minutes following shutdown of the power supply).
- The housing of the Ex-rated transmitter can be turned in 90° steps. Whereas the non-Ex version has a bayonet adapter, however, the Ex version has a thread. Recesses for centering the worm screw are provided to prevent inadvertent movement of the transmitter housing.
It is permissible to turn the transmitter housing through a maximum of 180° during operation (in either direction), without compromising explosion protection. After turning the housing the worm screw must be tightened again.
- The screw cap has to be removed before the local display can be turned, and this must be done with the device de-energized (and after a delay of at least 10 minutes following shutdown of the power supply).

Approvals

General

The system meets the fundamental health and safety requirements for the design and construction of devices and protective systems intended for use in potentially explosive atmospheres in accordance with the National Electrical Code.

No. / approval type

J.I. 3002554

Notified body

FM: Factory Mutual Research

Identification

The identification of the system contains the following specifications:

- XP-IS-DIP / I, II, III / 1 / ABCDEFG / T5-T1
- XP-IS / I / 1 / IIC / T5-T1

Description of measuring system

The measuring system consists of a compact version: transmitters and sensors form a mechanical unit.

Nameplate

The nameplates, which are mounted in a clearly visible position on the transmitter and sensor, contain all of the relevant information about the measuring system.

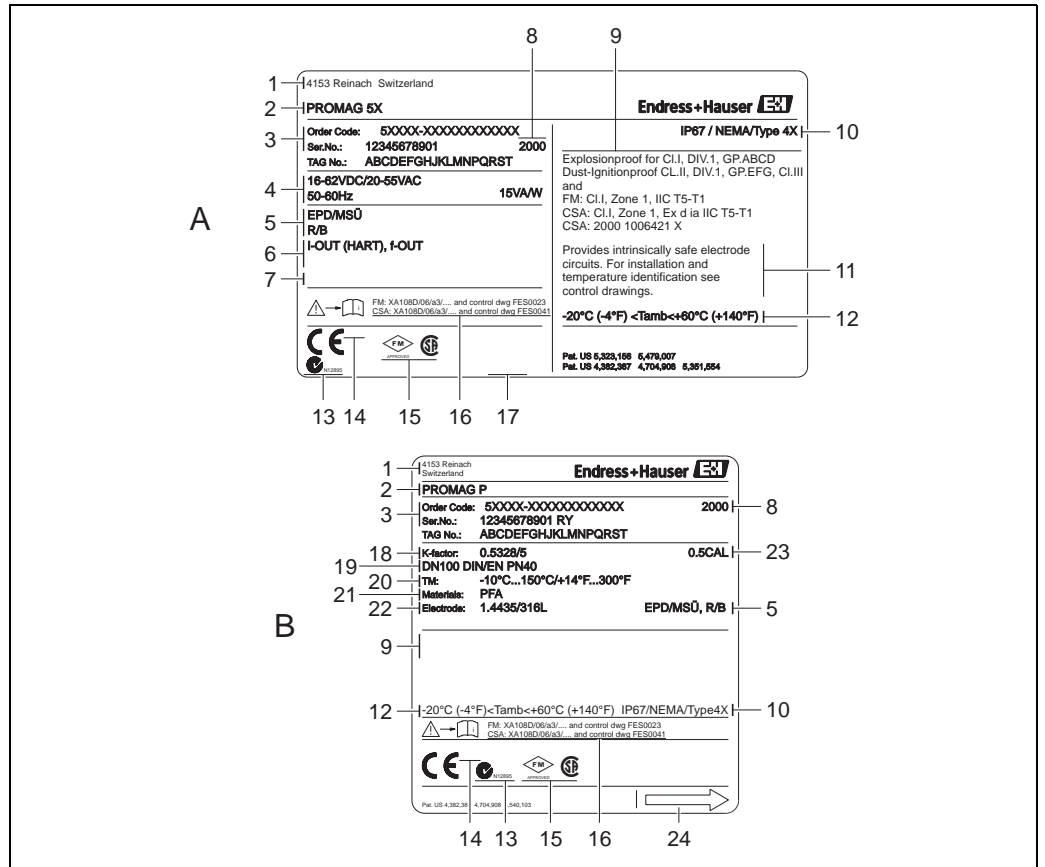

Fig. 1: Example for nameplates of a transmitter and of a sensor

A0005626

A Transmitter nameplate

B Sensor nameplate

- 1 Manufacturer / Certificate recipient
- 2 Transmitter or sensor type
- 3 Order code and serial number
- 4 Power supply, frequency and power consumption
- 5 Additional specifications, e.g. EPD = empty pipe detection, RB = reference electrode, etc. (only if present)
- 6 Available inputs/outputs
- 7 Space for additional information on special products
- 8 Year of manufacture
- 9 Space for additional information
- 10 Type of protection
- 11 Space for notes, e.g. delays, etc. (only if necessary)
- 12 Ambient temperature range
- 13 C-Tick symbol
- 14 Space for notified body for quality assurance monitoring
- 15 Label of notified body: Factory Mutual Research
- 16 Associated Ex documentation
- 17 Space for other approval specifications and certificates, e.g. PROFIBUS, etc. (only if present)
- 18 Calibration factor/zero point
- 19 Nominal diameter/nominal pressure
- 20 Fluid temperature range
- 21 Lining material
- 22 Measuring electrode material
- 23 Calibration tolerance
- 24 Direction of flow

Type code

The type code describes the exact design and the equipment of the measuring system. It can be read on the nameplate of the transmitter and sensor and is structured as follows:

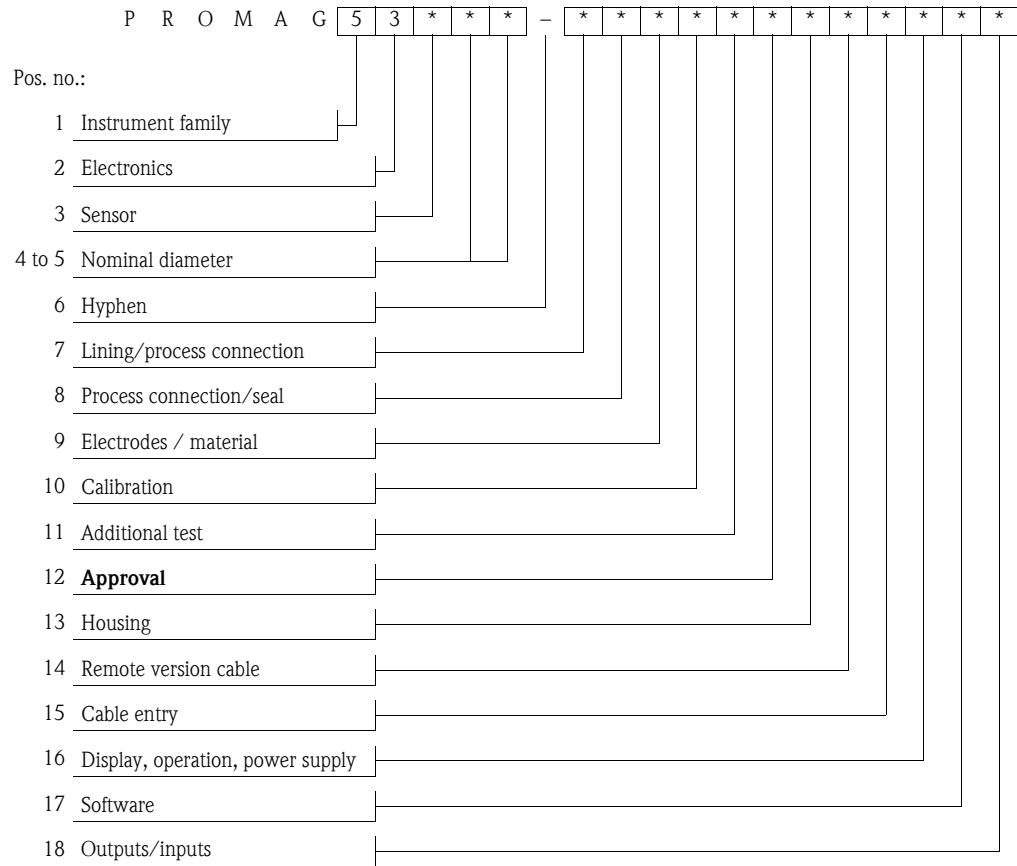
Transmitter approval (Pos. no. 12 in the type code)

*	Approval
N	XP-IS-DIP / I, II, III / 1 / ABCDEFG / T5-T1 XP-IS / I / 1 / IIC / T5-T1

Temperature table compact version

Max. medium temperature [°F] for T3B-T5 in relation to the ambient temperature T_a

	DN	T_a	T5 (212 °F)	T4A (248 °F)	T4 (275 °F)	T3C (320 °F)	T2 (572 °F)	T1 (842 °F)
Promag 5*W**_*****	1" to 12" ¹⁾	+122 °F	122	140	140	140	140	140
	2" to 12" ²⁾		122	176	176	176	176	176

¹⁾ with polyurethane lining; ²⁾ with hard-rubber lining

	DN	T_a	T5 (212 °F)	T4A (248 °F)	T4 (275 °F)	T3C (320 °F)	T2 (572 °F)	T1 (842 °F)
Promag 5*P**_*****	1" to 8" ¹⁾	+104 °F	122	230	266	302	302	302
	½" to 12" ²⁾					266	266	266
	1" to 8" ¹⁾	+113 °F	122	230	266	266	266	266
	½" to 12" ²⁾							
	1" to 8" ¹⁾	+122 °F	122	230	230	230	230	230
	½" to 12" ²⁾							

¹⁾ with PFA lining; ²⁾ with PTFE lining

	DN	T_a	T5 (212 °F)	T4A (248 °F)	T4 (275 °F)	T3C (320 °F)	T3B (329 °F)	T2 (572 °F)	T1 (842 °F)
Promag 5*H**_*****	1/12" to 4"	+104 °F	122	230	266	302	302	302	302
		+113 °F	122	230	266	266	266	266	266
		+122 °F	122	230	230	230	230	230	230

Note!

- At the specified medium temperatures, the equipment is not subjected to temperatures impermissible for the temperature class in question.
- The minimum permitted ambient temperature is -4 °F.
- A version for a minimum permitted ambient temperature of -40 °F is optionally available.

Design of measuring system

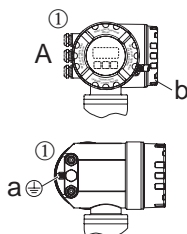

Fig. 2: Design of the measuring system, compact/remote version

A0005620

- A Transmitter housing
- a Screw terminal for connecting to the potential equalization
- b Connection compartment cover
- ① see following chapter "Cable entries"

Cable entries

① Cable entries for transmitter terminal compartment (XP version) power supply/communication cable. Choice of thread for cable entry: ½" NPT.

Make sure that the XP cable glands/entries are secured to prevent working loose.

Cable specification

You can find information about the cable specification in the associated Operating Instructions.

Potential equalization

The transmitter (compact and remote version) must be safely integrated into the potential equalization via the screw terminal on the outside of the transmitter housing. Alternatively, the transmitter of the compact version as of serial number 4Axxxxxx000 can be integrated into the potential equalization via the pipeline as long as the pipeline provides a ground connection conforming to regulations.

Note!

Further information about potential equalization, screening and grounding can be found in the associated Operating Instructions.

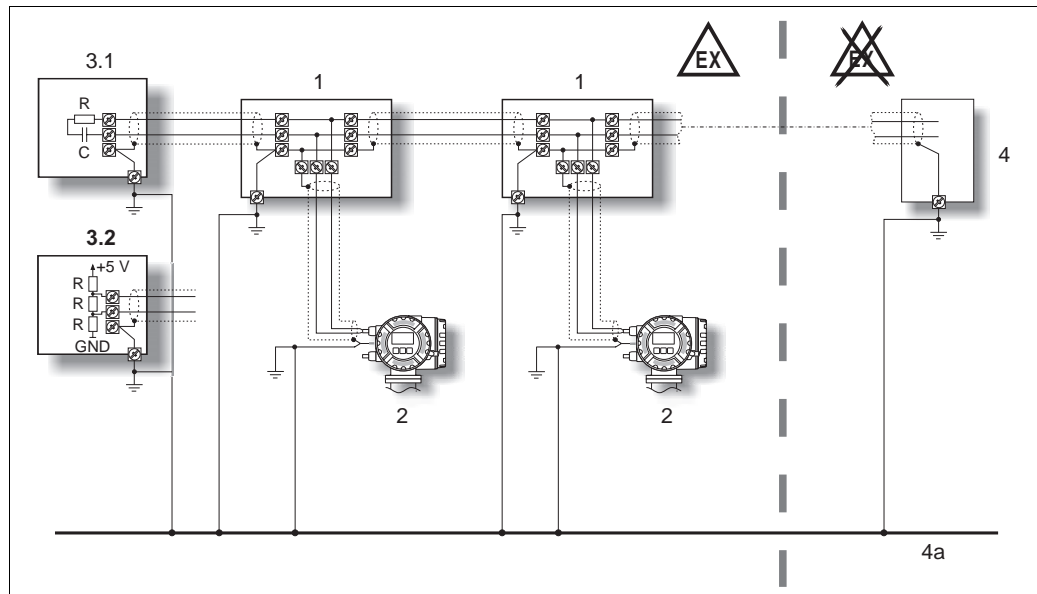
Potential equalization for fieldbus versions, when both sides of the screen are grounded

A0005215

Fig. 3: Example for connecting potential equalization lines

- 1 Distributor/T-Box
- 2 Bus devices for potentially explosive atmospheres
- 3.1 Bus termination PROFIBUS PA
- 3.2 Bus termination PROFIBUS DP
- 4 Bus power supply unit or automation system
- 4a Potential equalization line is fed out into the safe area

Note!

The length of the spurs is to consider.

Electrical connection
Connection compartment

Transmitter housing compact/remote version (terminal assignment, connection data → Page 8 ff.)

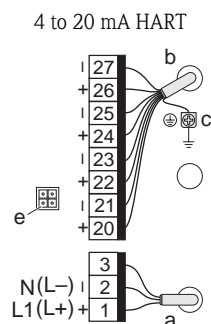

Fig. 4

A0013804

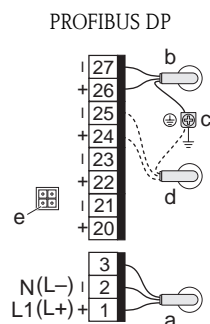

Fig. 5

A0013803

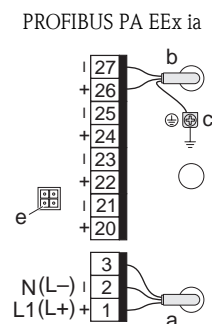

Fig. 6

A0013805

- a Power supply cable (terminal assignment and connection data → see following table)
- b Signal cable (terminal assignment and connection data → Page 9 ff.)
- c Ground terminal
- d Power supply cable for external termination (optional); terminal 24: +5 V / 25: DGND
- e Service adapter (see also Page 10)

Terminal assignment and connection data, power supply
Terminal assignment and connection data

all transmitters	1 L (+)	2 N (-)	3
Designation	Supply voltage (see nameplate)		Protective earth
Functional values	AC: U = 85 to 260 V or AC: U = 20 to 55 V, DC: U = 16 to 62 V Power consumption: 15 VA / 15 W		Caution! Observe the grounding plans of the system!
Intrinsically safe circuit	no		
U _m	260 V AC		

Terminal assignment and connection data for signal circuits (intrinsically safe circuits)

 Note!

The following tables contain values/specifications, which are dependent on the type code (type of measuring device). Please compare the following type code to the one shown on the nameplate of your measuring device. A graphic representation of the electrical connections can be found on Page 8.

Terminal assignment of transmitter 50***_*****F

Transmitter	Terminal no. (inputs/outputs)							
	20 (+)	21 (-)	22 (+)	23 (-)	24 (+)	25 (-)	26 (+)	27 (-)
Assignment	-			-			PROFIBUS PA PA + PA -	
Electric circuit	-			-			EEx ia	
Safety-related values	-			-			U _i	30 V DC
							I _i	500 mA
							P _i	5.5 W
							L _i	≤ 10 µH
							C _i	≤ 5 nF
							FISCO	Field device
Functional values	-			-			galvanically isolated, U _{Bus} 9 to 32 V DC I _{Bus} 11 mA IEC 61158-2 (MBP)	

Terminal assignment of transmitter 50***_*****S

Transmitter	Terminal no. (inputs/outputs)							
	20 (+)	21 (-)	22 (+)	23 (-)	24 (+)	25 (-)	26 (+)	27 (-)
Assignment	-		-		Pulse/frequency output, passive		Current output HART, active	
Electric circuit	-		-		Ex ia		Ex ia	
Safety-related values	-		-		U _i	30 V DC	U _o	21.8 V DC
					I _i	300 mA	I _o	90 mA
					P _i	600 mW	P _o	490 mW
					L _i IIC	0	L _o	4.1 mH
					C _i IIC	6 nF	C _o	150 nF
							U _i	30 V DC ¹⁾
							I _i	10 mA ¹⁾
							P _i	0.3 W ¹⁾
							L _i	0
							C _i	6 nF
Functional values	-		-		galvanically isolated, passive: 30 V DC / 250 mA Open Collector Full scale frequency 2 to 5000 Hz		galvanically isolated, active: 0/4 to 20 mA R _L < 400 Ω R _L HART ≥ 250 Ω	

¹⁾ The interconnection must be assessed according to the valid construction provisions.

Terminal assignment of transmitter 50***_*****T

Transmitter	Terminal no. (inputs/outputs)							
	20 (+)	21 (-)	22 (+)	23 (-)	24 (+)	25 (-)	26 (+)	27 (-)
Assignment	-		-		Pulse/frequency output, passive		Current output HART, passive	
Electric circuit	-		-		Ex ia		Ex ia	
Safety-related values	-		-		U _i	30 V DC	U _i	30 V DC
					I _i	300 mA	I _i	100 mA
					P _i	600 mW	P _i	1.25 W
					L _i IIC	0	L _i IIC	negligible
					C _i IIC	6 nF	C _i IIC	6 nF
Functional values	-		-		galvanically isolated, passive: 30 V DC / 250 mA Open Collector Full scale frequency 2 to 5000 Hz		galvanically isolated, passive: 4 to 20 mA voltage drop ≤ 9 V R _L < [(V _{supply} - 9 V) ÷ 25 mA]	

Terminal assignment and connection data for signal circuits (non-intrinsically safe circuits)

 Note!

The following tables contain values/specifications, which are dependent on the type code (type of measuring device). Please compare the following type code to the one shown on the nameplate of your measuring device. A graphic representation of the electrical connections can be found on Page 8.

Terminal assignment

Transmitter	Terminal no. (inputs/outputs)							
	20 (+)	21 (-)	22 (+)	23 (-)	24 (+)	25 (-)	26 (+)	27 (-)
50***-...*A	–	–	–	–	Pulse/frequency output		Current output HART	
50***-...*D	Status input		Relay output		Pulse/frequency output		Current output HART	
50***-...*J	–	–	–	–	External termination +5 V DGND		PROFIBUS DP * B A	
50***-...*W	–	–	–	–	–		Current output HART	

* PROFIBUS DP:
 – terminal 26 (+) → B (Rx/D/TxD-P)
 – terminal 27 (-) → A (Rx/D/TxD-N)

Safety-related and functional values of signal circuits

Signal circuits	Functional values	Safety-related values
Current output HART	galvanically isolated, active/passive can be selected: <ul style="list-style-type: none"> ■ active: 0/4 to 20 mA $R_L < 700 \Omega$, $R_L \text{ HART} \geq 250 \Omega$ ■ passive: 4 to 20 mA $V_s = 18 \text{ to } 30 \text{ V DC}$, $R_i \geq 150 \Omega$ 	intrinsically = no safe = 250 V $U_m = 500 \text{ mA}$ I_m
Pulse/frequency output	galvanically isolated, active/passive can be selected: <ul style="list-style-type: none"> ■ active: 24 V DC / 25 mA (max. 250 mA during 20 ms) $R_L > 100 \Omega$ ■ passive: 30 V DC / 250 mA Open Collector Full scale frequency 2 to 1000 Hz ($f_{\max} = 1250 \text{ Hz}$)	
Relay output	galvanically isolated, max. 30 V AC / 500 mA max. 60 V DC / 100 mA	
Status input	galvanically isolated, 3 to 30 V DC $R_i = 5 \text{ k}\Omega$	
PROFIBUS DP	galvanically isolated, RS485 as per Standard EIA/TIA-485	

Service adapter

The service adapter is only used for connecting service interfaces approved by Endress+Hauser.

 Warning!

It is not permissible to connect the service adapter whilst the atmosphere is considered to be explosive.

Device fuse

 Warning!

Use only fuses of the following types; the fuses are installed on the power supply board:

- Voltage 20 to 55 V AC / 16 to 62 V DC:
Fuse 2.0 A slow-blow, disconnect capacity 1500 A
(Schurter, 0001.2503 or Wickmann, Standard Type 181 2.0 A)
- Voltage 85 to 260 V AC:
Fuse 0.8 A slow-blow, disconnect capacity 1500 A
(Schurter, 0001.2507 or Wickmann, Standard Type 181 0.8 A)

Technical Data**Dimensions**

Please refer to the respective Technical Information for these dimensions:

- Promag 50W, 53W → TI046D
- Promag 50P, 53P → TI047D
- Promag 50H, 53H → TI048D

Weight

The weight of the EEx d version is approx. 4.4 lbs greater than that of the standard version.

Control Drawings

Endress+Hauser Reinach hereby declares that the product is in conformity with the requirements of the FACTORY MUTUAL standard.

 Note!

The "Documentation/Important Information" folder provided with the measuring device contains a CD-ROM with all the Control Drawings.





Level



Pressure



Flow



Temperature



Liquid
Analysis



Registration



Systems
Components



Services



Solutions

Safety Instructions

Proline Promag 50

HART, PROFIBUS DP/PA

Division 1

Ex documentation

This document is an integral part of the following Operating Instructions:

- BA046D, Proline Promag 50 HART
- BA055D, Proline Promag 50 PROFIBUS DP/PA

Table of Contents CSA

Special conditions	14
General warnings	14
Approvals	14
Description of measuring system	15
Nameplate	15
Type code	16
Temperature table compact version	17
Design of measuring system	17
Cable entries	17
Cable specification	17
Potential equalization	17
Electrical connection	18
Terminal assignment and connection data, power supply	18
Terminal assignment and connection data for signal circuits (intrinsically safe circuits)	19
Terminal assignment and connection data for signal circuits (non-intrinsically safe circuits)	20
Service adapter	20
Device fuse	20
Technical Data	21
Control Drawings	21

Special conditions

- Install per Canadian Electrical Code.
 - Control room equipment shall not use or generate more than 250 V rms.
 - The device must be integrated into the potential equalization system.
 - For terminals No. 20 to No. 27 of the transmitter, only devices with ratings $U_m \leq 250$ V and $I_m \leq 500$ mA are allowed to be connected (does not apply to intrinsically safe circuits).
 - The specified temperature class in conjunction with the ambient temperature and the medium temperature must be in compliance with the tables on Page 17.
 - It is not permissible to connect the service adapter whilst the atmosphere is considered to be explosive.
 - Use of the devices is restricted to mediums against which the process-wetted materials are adequately resistant.
 - Transmitter enclosure is factory sealed for use in Class I, Div. 1, Groups B, C, D.
-  Caution!
- Use supply wires suitable for 5 °C above ambient temperature, but at least for 80 °C.

General warnings

- Installation, connection to the electricity supply, commissioning and maintenance of the devices must be carried out by qualified specialists trained to work on Ex-rated devices.
- Compliance with national regulations relating to the installation of devices in potentially explosive atmospheres is mandatory, if such regulations exist.
- Open the device only when it is de-energized (and after a delay of at least 10 minutes following shutdown of the power supply).
- The housing of the Ex-rated transmitter can be turned in 90° steps. Whereas the non-Ex version has a bayonet adapter, however, the Ex version has a thread. Recesses for centering the worm screw are provided to prevent inadvertent movement of the transmitter housing.
It is permissible to turn the transmitter housing through a maximum of 180° during operation (in either direction), without compromising explosion protection. After turning the housing the worm screw must be tightened again.
- The screw cap has to be removed before the local display can be turned, and this must be done with the device de-energized (and after a delay of at least 10 minutes following shutdown of the power supply).

Approvals

General

The system meets the fundamental health and safety requirements for the design and construction of devices and protective systems intended for use in potentially explosive atmospheres in accordance with the Canadian Electrical Code.

Certification number

160686-1006421

Inspection body

CSA: Canadian Standard Association

Identification

The identification of the system contains the following specifications:

- Class I, Groups ABCD
- Class I, Zone 1, Group IIC
- Class II, Groups EFG
- Class III

Description of measuring system

The measuring system consists of a compact version: transmitters and sensors form a mechanical unit.

Nameplate

The nameplates, which are mounted in a clearly visible position on the transmitter and sensor, contain all of the relevant information about the measuring system.

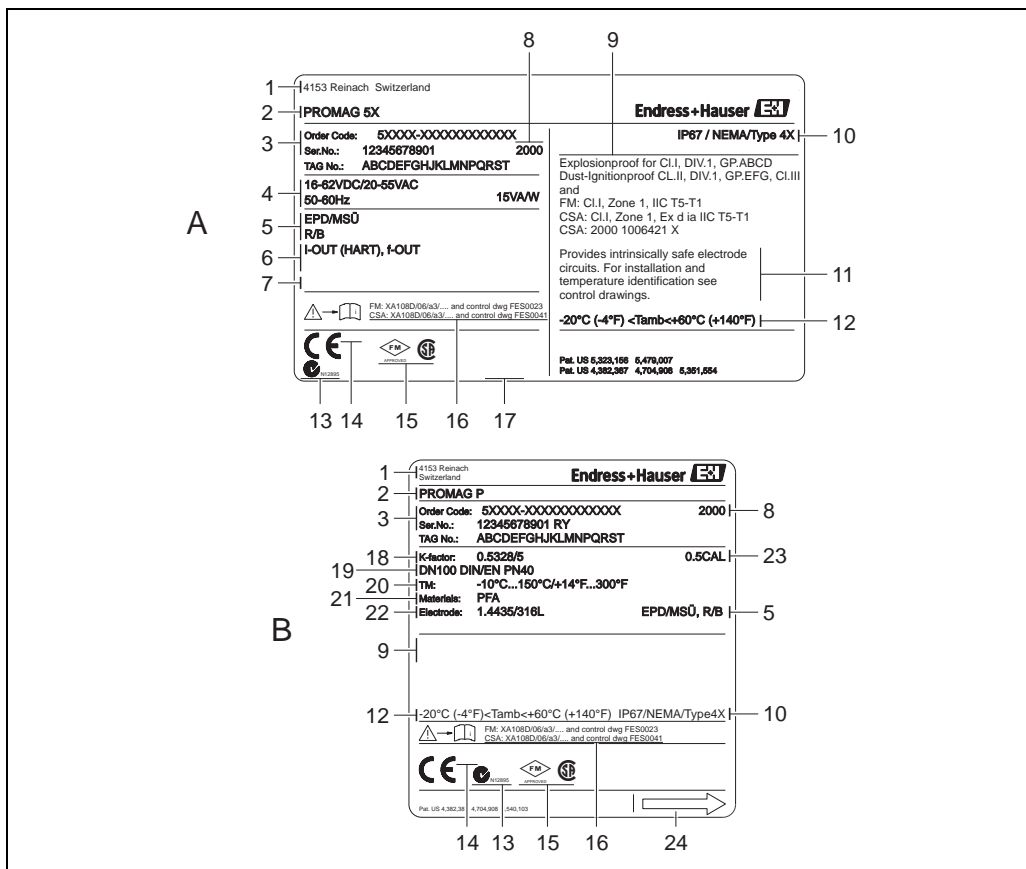

Fig. 1: Example for nameplates of a transmitter and of a sensor

- A Transmitter nameplate
- B Sensor nameplate
- 1 Manufacturer / Certificate recipient
- 2 Transmitter or sensor type
- 3 Order code and serial number
- 4 Power supply, frequency and power consumption
- 5 Additional specifications, e.g. EPD = empty pipe detection, RB = reference electrode, etc. (only if present)
- 6 Available inputs/outputs
- 7 Space for additional information on special products
- 8 Year of manufacture
- 9 Space for additional information
- 10 Type of protection
- 11 Space for notes, e.g. delays, etc. (only if necessary)
- 12 Ambient temperature range
- 13 C-Tick symbol
- 14 Space for notified body for quality assurance monitoring
- 15 Label of notified body: Canadian Standards Association
- 16 Associated Ex documentation
- 17 Space for other approval specifications and certificates, e.g. PROFIBUS, etc. (only if present)
- 18 Calibration factor/zero point
- 19 Nominal diameter/nominal pressure
- 20 Fluid temperature range
- 21 Lining material
- 22 Measuring electrode material
- 23 Calibration tolerance
- 24 Direction of flow

Temperature table compact version

Max. medium temperature [°C] for T3B–T5 in relation to the ambient temperature T_a

	DN	T_a	T5 (100 °C)	T4A (120 °C)	T4 (135 °C)	T3C (160 °C)	T2 (300 °C)	T1 (450 °C)
Promag 5*W**_*****	25 to 300 ¹⁾	+50 °C	50	60	60	60	60	60
	50 to 300 ²⁾		50	80	80	80	80	80

¹⁾ with polyurethane lining; ²⁾ with hard-rubber lining

	DN	T_a	T5 (100 °C)	T4A (120 °C)	T4 (135 °C)	T3C (160 °C)	T2 (300 °C)	T1 (450 °C)
Promag 5*P**_*****	25 to 200 ¹⁾	+40 °C	50	110	130	150	150	150
	15 to 300 ²⁾					130	130	130
	25 to 200 ¹⁾	+45 °C	50	110	130	130	130	130
	15 to 300 ²⁾							
	25 to 200 ¹⁾	+50 °C	50	110	110	110	110	110
	15 to 300 ²⁾							

¹⁾ with PFA lining; ²⁾ with PTFE lining

	DN	T_a	T5 (100 °C)	T4A (120 °C)	T4 (135 °C)	T3C (160 °C)	T3B (165 °C)	T2 (300 °C)	T1 (450 °C)
Promag 5*H**_*****	2 to 100	+40 °C	50	110	130	150	150	150	150
		+45 °C	50	110	130	130	130	130	130
		+50 °C	50	110	110	110	110	110	110

Note!

- At the specified medium temperatures, the equipment is not subjected to temperatures impermissible for the temperature class in question.
- The minimum permitted ambient temperature is –20 °C.
- A version for a minimum permitted ambient temperature of –40 °C is optionally available.

Design of measuring system

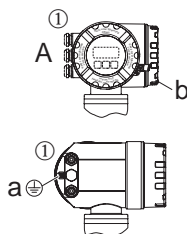

Fig. 2: Design of the measuring system, compact/remote version

- A Transmitter housing
- a Screw terminal for connecting to the potential equalization
- b Connection compartment cover
- ① see following chapter "Cable entries"

Cable entries

① Cable entries for transmitter terminal compartment (XP version) power supply/communication cable. Choice of thread for cable entry: 1/2" NPT.

Make sure that the XP cable glands/entries are secured to prevent working loose and that the seals are installed immediately adjacent to the housing, if required (Class I, Div. 1, Group A).

Cable specification

You can find information about the cable specification in the associated Operating Instructions.

Potential equalization

The transmitter (compact and remote version) must be safely integrated into the potential equalization via the screw terminal on the outside of the transmitter housing. Alternatively, the transmitter of the compact version as of serial number 4Axxxxxx000 can be integrated into the potential equalization via the pipeline as long as the pipeline provides a ground connection conforming to regulations.

Note!

Further information about potential equalization, screening and grounding can be found in the associated Operating Instructions.

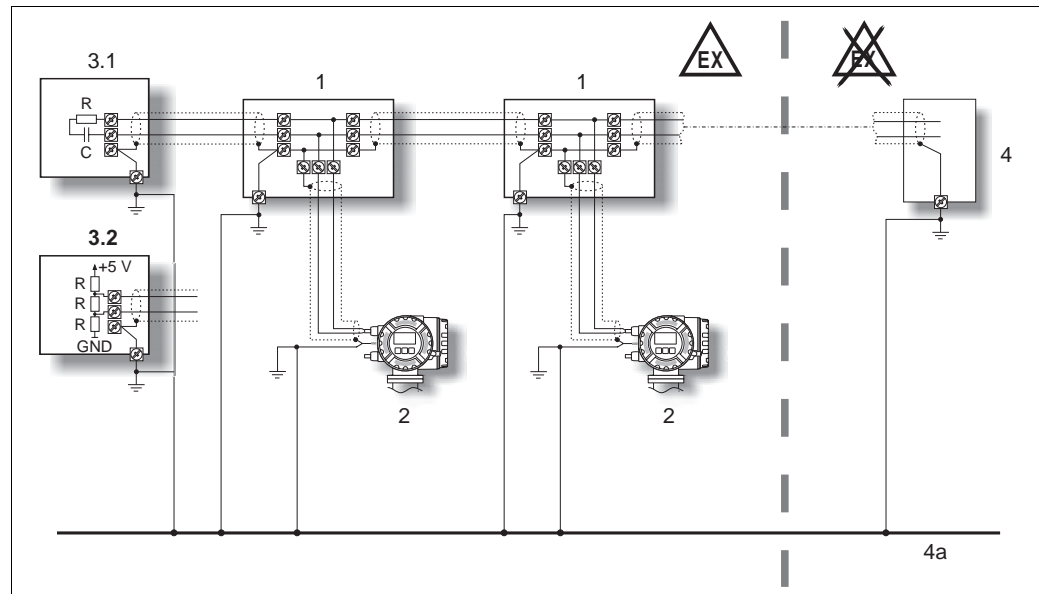
Potential equalization for fieldbus versions, when both sides of the screen are grounded

A0005215

Fig. 3: Example for connecting potential equalization lines

- 1 Distributor/T-Box
- 2 Bus devices for potentially explosive atmospheres
- 3.1 Bus termination PROFIBUS PA
- 3.2 Bus termination PROFIBUS DP
- 4 Bus power supply unit or automation system
- 4a Potential equalization line is fed out into the safe area

Note!

The length of the spurs is to consider.

Electrical connection
Connection compartment

Transmitter housing compact/remote version (terminal assignment, connection data → Page 18 ff.)

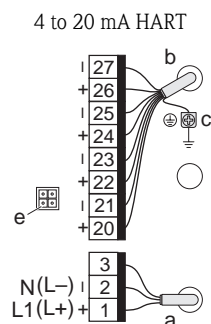

Fig. 4

A0013804

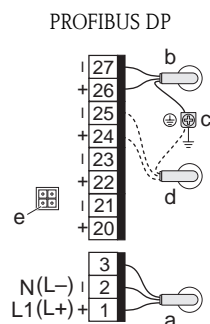

Fig. 5

A0013803

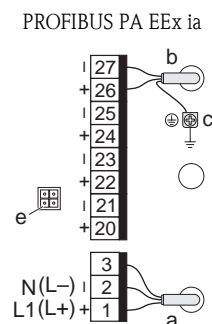

Fig. 6

A0013805

- a Power supply cable (terminal assignment and connection data → see following table)
- b Signal cable (terminal assignment and connection data → Page 19 ff.)
- c Ground terminal
- d Power supply cable for external termination (optional); terminal 24: +5 V / 25: DGND
- e Service adapter (see also Page 20)

Terminal assignment and connection data, power supply
Terminal assignment and connection data

all transmitters	1 L (+)	2 N (-)	3
Designation	Supply voltage (see nameplate)		Protective earth
Functional values	AC: U = 85 to 260 V or AC: U = 20 to 55 V, DC: U = 16 to 62 V Power consumption: 15 VA / 15 W		Caution! Observe the grounding plans of the system!
Intrinsically safe circuit	no		
U _m	260 V AC		

Terminal assignment and connection data for signal circuits (intrinsically safe circuits)

Note!

The following tables contain values/specifications, which are dependent on the type code (type of measuring device). Please compare the following type code to the one shown on the nameplate of your measuring device. A graphic representation of the electrical connections can be found on Page 18.

Terminal assignment of transmitter 50*_*****F**

Transmitter	Terminal no. (inputs/outputs)							
	20 (+)	21 (-)	22 (+)	23 (-)	24 (+)	25 (-)	26 (+)	27 (-)
Assignment	-		-		-		PROFIBUS PA PA + PA -	
Electric circuit	-		-		-		EEx ia	
Safety-related values	-		-		-		U _i 30 V DC I _i 500 mA P _i 5.5 W L _i ≤ 10 µH C _i ≤ 5 nF FISCO Field device	
Functional values	-		-		-		galvanically isolated, U _{Bus} 9 to 32 V DC I _{Bus} 11 mA IEC 61158-2 (MBP)	

Terminal assignment of transmitter 50*_*****S**

Transmitter	Terminal no. (inputs/outputs)							
	20 (+)	21 (-)	22 (+)	23 (-)	24 (+)	25 (-)	26 (+)	27 (-)
Assignment	-		-		Pulse/frequency output, passive		Current output HART, active	
Electric circuit	-		-		Ex ia		Ex ia	
Safety-related values	-		-		U _i 30 V DC I _i 300 mA P _i 600 mW L _i IIC 0 C _i IIC 6 nF	U _o 21.8 V DC I _o 90 mA P _o 490 mW L _o 4.1 mH C _o 150 nF U _i 30 V DC ¹⁾ I _i 10 mA ¹⁾ P _i 0.3 W ¹⁾ L _i 0 C _i 6 nF		
Functional values	-		-		galvanically isolated, passive: 30 V DC / 250 mA Open Collector Full scale frequency 2 to 5000 Hz		galvanically isolated, active: 0/4 to 20 mA R _L < 400 Ω R _L HART ≥ 250 Ω	

¹⁾ The interconnection must be assessed according to the valid construction provisions.

Terminal assignment of transmitter 50*_*****T**

Transmitter	Terminal no. (inputs/outputs)							
	20 (+)	21 (-)	22 (+)	23 (-)	24 (+)	25 (-)	26 (+)	27 (-)
Assignment	-		-		Pulse/frequency output, passive		Current output HART, passive	
Electric circuit	-		-		Ex ia		Ex ia	
Safety-related values	-		-		U _i 30 V DC I _i 300 mA P _i 600 mW L _i IIC 0 C _i IIC 6 nF	U _i 30 V DC I _i 100 mA P _i 1.25 W L _i IIC negligible C _i IIC 6 nF		
Functional values	-		-		galvanically isolated, passive: 30 V DC / 250 mA Open Collector Full scale frequency 2 to 5000 Hz		galvanically isolated, passive: 4 to 20 mA voltage drop ≤ 9 V R _L < [(V _{supply} - 9 V) ÷ 25 mA]	

Terminal assignment and connection data for signal circuits (non-intrinsically safe circuits)

Note!

The following tables contain values/specifications, which are dependent on the type code (type of measuring device). Please compare the following type code to the one shown on the nameplate of your measuring device. A graphic representation of the electrical connections can be found on Page 18.

Terminal assignment

Transmitter	Terminal no. (inputs/outputs)							
	20 (+)	21 (-)	22 (+)	23 (-)	24 (+)	25 (-)	26 (+)	27 (-)
50***-...*A	–	–	–	–	Pulse/frequency output		Current output HART	
50***-...*D	Status input		Relay output		Pulse/frequency output		Current output HART	
50***-...*J	–	–	–	–	External termination +5 V DGND		PROFIBUS DP * B A	
50***-...*W	–	–	–	–	–		Current output HART	

* PROFIBUS DP:
 – terminal 26 (+) → B (Rx/D/TxD-P)
 – terminal 27 (-) → A (Rx/D/TxD-N)

Safety-related and functional values of signal circuits

Signal circuits	Functional values	Safety-related values
Current output HART	galvanically isolated, active/passive can be selected: ■ active: 0/4 to 20 mA $R_L < 700 \Omega$, $R_L \text{ HART} \geq 250 \Omega$ ■ passive: 4 to 20 mA $V_s = 18$ to 30 V DC, $R_i \geq 150 \Omega$	intrinsically = no safe = 250 V $U_m = 500$ mA I_m
Pulse/frequency output	galvanically isolated, active/passive can be selected: ■ active: 24 V DC / 25 mA (max. 250 mA during 20 ms) $R_L > 100 \Omega$ ■ passive: 30 V DC / 250 mA Open Collector Full scale frequency 2 to 1000 Hz ($f_{max} = 1250$ Hz)	
Relay output	galvanically isolated, max. 30 V AC / 500 mA max. 60 V DC / 100 mA	
Status input	galvanically isolated, 3 to 30 V DC $R_i = 5$ k Ω	
PROFIBUS DP	galvanically isolated, RS485 as per Standard EIA/TIA-485	

Service adapter

The service adapter is only used for connecting service interfaces approved by Endress+Hauser.

Warning!

It is not permissible to connect the service adapter whilst the atmosphere is considered to be explosive.

Device fuse

Warning!

Use only fuses of the following types; the fuses are installed on the power supply board:

- Voltage 20 to 55 V AC / 16 to 62 V DC:
Fuse 2.0 A slow-blow, disconnect capacity 1500 A (Schurter, 0001.2503 or Wickmann, Standard Type 181 2.0 A)
- Voltage 85 to 260 V AC:
Fuse 0.8 A slow-blow, disconnect capacity 1500 A (Schurter, 0001.2507 or Wickmann, Standard Type 181 0.8 A)

Technical Data**Dimensions**

Please refer to the respective Technical Information for these dimensions:

- Promag 50W, 53W → TI046D
- Promag 50P, 53P → TI047D
- Promag 50H, 53H → TI048D

Weight

The weight of the EEx d version is approx. 2 kg greater than that of the standard version.

Control Drawings

Endress+Hauser Reinach hereby declares that the product is in conformity with the requirements of the CANADIAN STANDARDS ASSOCIATION.

 Note!

The "Documentation/Important Information" folder provided with the measuring device contains a CD-ROM with all the Control Drawings.

www.endress.com/worldwide

Endress+Hauser 
People for Process Automation