



Level



Pressure



Flow



Temperature



Liquid
Analysis



Registration



Systems
Components



Services



Solutions

Brief Operating Instructions

Cubemass DCI

Coriolis mass flow measuring system



MODBUS RS485

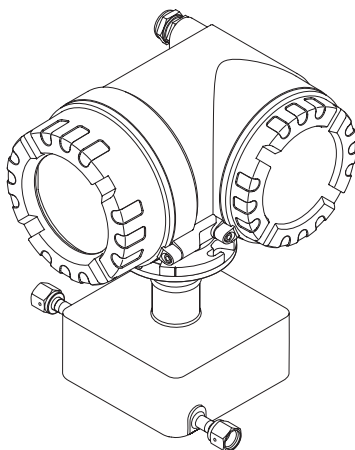

These Brief Operating Instructions are **not** intended to replace the Operating Instructions provided in the scope of supply. Detailed information is provided in the Operating Instructions and the additional documentation on the CD-ROM supplied.

Depending on the device version, the complete device documentation consists of:

- Brief Operating Instructions (this document)
- Operating Instructions
- Description of Device Parameters
- Approvals and safety certificates
- Safety instructions in accordance with the approvals for the device (e.g. explosion protection, pressure equipment directive etc.)
- Additional device-specific information

Table of contents

1 Safety instructions	3
1.1 Designated use	3
1.2 Installation, commissioning and operation	3
1.3 Operational safety	3
1.4 Safety conventions	5
2 Installation	6
2.1 Transporting to the measuring point	6
2.2 Installation conditions	6
2.3 Post-installation	7
2.4 Post-installation check	9
3 Wiring	10
3.1 Connecting the various housing types	11
3.2 Degree of protection	12
3.3 Post-connection check	12
4 Hardware settings	13
4.1 Device address	13
4.2 Terminating resistors	15
5 Commissioning	16
5.1 Switching on the measuring device	16
5.2 Operation	17
5.3 Navigating within the function matrix	18
5.4 Calling the "Commissioning" Quick Setup	19
5.5 Software settings	20
5.6 Troubleshooting	21

1 Safety instructions

1.1 Designated use

- The measuring device may only be used to measure the mass flow of liquids and gases. At the same time, the measuring device also measures the fluid density and temperature, which means that additional process variables, such as the volume flow, can be calculated as a result.
- Any use other than that described here compromises the safety of persons and the entire measuring system and is, therefore, not permitted.
- The manufacturer is not liable for damage caused by improper or non-designated use.

1.2 Installation, commissioning and operation

- The measuring device must only be installed, connected, commissioned and maintained by qualified and authorized specialists (e.g. electrical technicians) in full compliance with the instructions in these Brief Operating Instructions, the applicable norms, legal regulations and certificates (depending on the application).
- The specialists must have read and understood these Brief Operating Instructions and must follow the instructions they contain. If you are unclear on anything in these Brief Operating Instructions, you must read the Operating Instructions (on the CD-ROM). The Operating Instructions provide detailed information on the measuring device.
- The measuring device may only be installed in a de-energized state, free from external loads.
- The measuring device may only be modified if such work is expressly permitted in the Operating Instructions (on the CD-ROM).
- Repairs may only be performed if a genuine spare parts kit is available and this repair work is expressly permitted.
- If performing welding work on the piping, the welding unit may not be grounded by means of the measuring device.

1.3 Operational safety

- The measuring device is designed to meet state-of-the-art safety requirements, has been tested, and left the factory in a condition in which it is safe to operate. Relevant regulations and European standards have been observed.
- The information on the warning signs, nameplates and connection labels must be observed. They contain important data on the permitted operating conditions, the operating range of the device and the material.
If the measuring device is not used at atmospheric temperatures, compliance with the relevant boundary conditions in accordance with the device documentation supplied (on the CD-ROM) is mandatory.
- The measuring device must be wired in accordance with the wiring diagrams and connection labels. Interconnection must be permitted.
- All parts of the measuring device must be included in the potential equalization of the plant.

- Cables, certified cable glands and certified dummy plugs must be suitable for the prevailing operating conditions, such as the temperature range of the process for example. Unused housing openings must be sealed with dummy plugs.
- The measuring device may only be used in conjunction with fluids to which all wetted parts of the measuring device are sufficiently resistant. With regard to special fluids, including fluids used for cleaning, Endress+Hauser will be happy to assist in clarifying the corrosion-resistant properties of wetted materials.

However, minor changes in temperature, concentration or in the degree of contamination in the process may result in variations in corrosion resistance.

For this reason, Endress+Hauser does not accept any responsibility with regard to the corrosion resistance of wetted materials in a specific application. The user is responsible for the choice of suitable wetted materials in the process.

- Hazardous areas

Measuring devices for use in hazardous areas are labeled accordingly on the nameplate.

Relevant national regulations must be observed when operating the device in hazardous areas.

The Ex documentation on the CD-ROM is an integral part of the entire device documentation.

The installation regulations, connection data and safety instructions provided in the Ex documentation must be observed. The symbol and the name on the front page provide information on the approval/certification body (e.g.  Europe, NEC/CEC, NEPSI). The nameplate also bears the documentation number of this Ex documentation (XA***D/.../..).

- For measuring systems used in SIL 2 applications, the separate manual on functional safety (on the CD-ROM) must be observed.
- Hygienic applications
Measuring devices for hygienic applications have their own special labeling. Relevant national regulations must be observed when using these devices.
- Pressure instruments
Measuring devices for use in systems that need to be monitored are labeled accordingly on the nameplate. Relevant national regulations must be observed when using these devices. The documentation on the CD-ROM for pressure instruments in systems that need to be monitored is an integral part of the entire device documentation. The installation regulations, connection data and safety instructions provided in the Ex documentation must be observed.
- Endress+Hauser will be happy to assist in clarifying any questions on approvals, their application and implementation.

1.4 Safety conventions



Warning!

"Warning" indicates an action or procedure which, if not performed correctly, can result in injury or a safety hazard. Comply strictly with the instructions and proceed with care.



Caution!

"Caution" indicates an action or procedure which, if not performed correctly, can result in incorrect operation or destruction of the device. Comply strictly with the instructions.



Note!

"Note" indicates an action or procedure which, if not performed correctly, can have an indirect effect on operation or trigger an unexpected response on the part of the device.

2 Installation

2.1 Transporting to the measuring point

- Transport the measuring device to the measuring point in the original packaging.
- The covers or caps fitted on the process connections prevent mechanical damage to the sensors during transport and storage. For this reason, do not remove the covers or caps until immediately before installation.

2.2 Installation conditions

Measuring device is intended for table, wall and pipe mounting.

2.2.1 Dimensions

For the dimensions of the measuring device → see associated Technical Information on the CD-ROM.

2.2.2 Inlet and outlet runs

When mounting, no special precautions need to be taken for fittings which create turbulence (valves, elbows, T-pieces etc.).

2.2.3 Vibrations

The high oscillation frequency of the measuring tubes ensures that the correct operation of the measuring system is not affected by plant vibrations. Consequently, no special attachment measures are required for the sensors.

2.3 Post-installation

2.3.1 Turning the transmitter housing

Turning the aluminum field housing

Aluminum field housing for non-Ex area

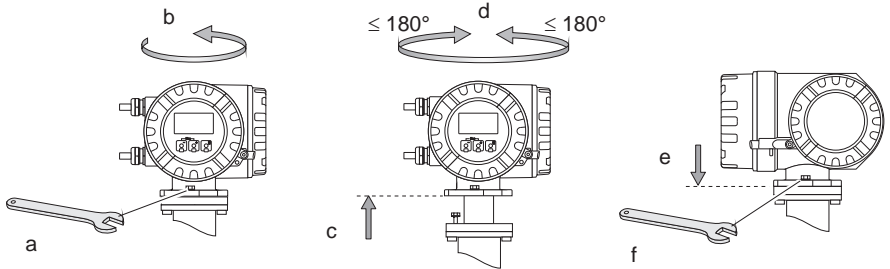

A0012374

Aluminum field housing for Zone 1 or Class I Div. 1

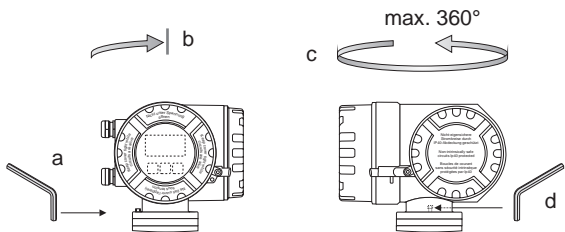

A0008036

- Release the setscrew.
- Turn the transmitter housing gently clockwise until the stop (end of the thread).
- Turn the transmitter counterclockwise (max. 360°) to the desired position.
- Retighten the setscrew.

2.3.2 Turning the onsite display

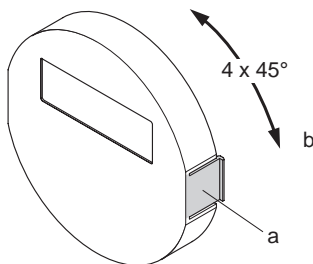

- Press in the side latches on the display module and remove the module from the cover plate of the electronics compartment.
- Turn the display to the desired position (max. 4 x 45° in both directions) and reset it onto the cover plate of the electronics compartment.

A0007541

2.3.3 Installing the wall-mount housing

☞ Caution!

- Make sure that the ambient temperature does not exceed the permitted range.
- Always install the wall-mount housing in such a way that the cable entries point downwards.

Mounted directly on the wall

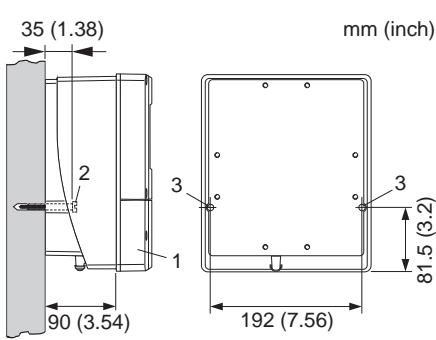

1. Connection compartment
2. Securing screws M6 (max. \varnothing 6.5 mm (0.26"); screw head max. \varnothing 10.5 mm (0.41"))
3. Housing bores for securing screws

A0007542

Pipe mounting

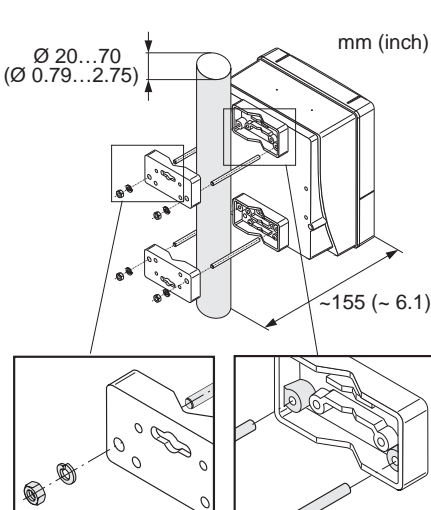

☞ Caution!
 Danger of overheating! If the device is mounted on a warm pipe, make sure that the housing temperature does not exceed +60 °C (+140 °F) which is the maximum temperature permitted.

A0007543

Panel mounting

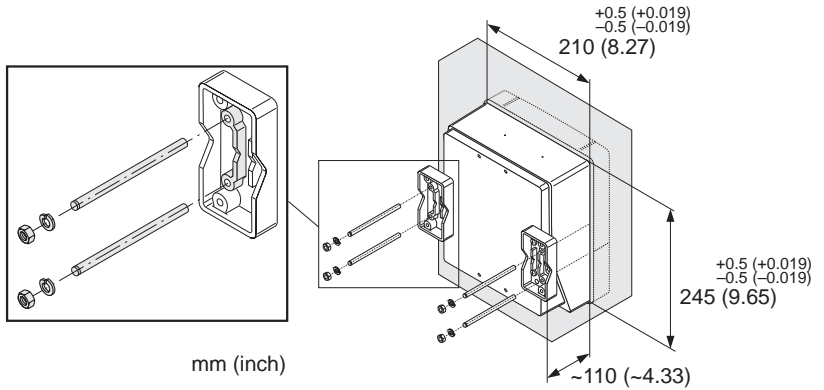

A0007544

2.4 Post-installation check

- Is the measuring device damaged (visual inspection)?
- Does the measuring device correspond to the specifications at the measuring point?
- Are the measuring point number and labeling correct (visual inspection)?
- Has the correct sensor orientation been selected in terms of type, fluid properties, fluid temperature?
- Does the arrow on the sensor point in the direction of the flow in the pipe?
- Is the measuring device protected against rain and sunlight?

3 Wiring

Warning!

Risk of electric shock! Components carry dangerous voltages.

- Never mount or wire the measuring device while it is connected to the power supply.
- Prior to connecting the power supply, connect the protective ground to the ground terminal on the housing.
- Route the power supply and signal cables so they are securely seated.
- Seal the cable entries and covers so they are airtight.

Caution!

Risk of damaging the electronic components!

- Connect the power supply in accordance with the connection data on the nameplate.
- Connect the signal cable in accordance with the connection data in the Operating Instructions or the Ex documentation on the CD-ROM.

In addition, for the remote version:

Caution!

Risk of damaging the electronic components!

- Only connect sensors and transmitters with the same serial number
- Observe the cable specifications of the connecting cable → Operating Instructions on the CD-ROM.

Note!

Install the connecting cable securely to prevent movement.

In addition, for measuring devices with fieldbus communication:

Caution!

Risk of damaging the electronic components!

- Observe the cable specification of the fieldbus cable → Operating Instructions on the CD-ROM.
- Keep the stripped and twisted lengths of cable shield as short as possible.
- Screen and ground the signal lines → Operating Instructions on the CD-ROM.
- When using in systems without potential matching → Operating Instructions on the CD-ROM.

In addition, for Ex-certified measuring devices:

Warning!

When wiring Ex-certified measuring devices, all the safety instructions, wiring diagrams, technical information etc. of the related Ex documentation must be observed
→ Ex documentation on the CD-ROM.

3.1 Connecting the various housing types

Wire the unit using the terminal assignment diagram inside the cover.

3.1.1 Compact version (transmitter): non-Ex Zone, Ex Zone 1, Class I Div. 1

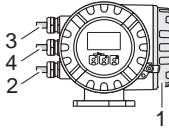

Transmitter connection:

- 1 Connection diagram inside the connection compartment cover
- 2 Power supply cable
- 3 Signal cable or fieldbus cable
- 4 Optional

A0012373

3.1.2 Remote version (transmitter): non-Ex zone

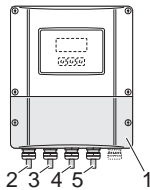

Transmitter connection:

- 1 Connection diagram inside the connection compartment cover
- 2 Power supply cable
- 3 Signal cable
- 4 Fieldbus cable

Connecting cable connection:

- 5 Sensor/transmitter connecting cable

A0007546

3.1.3 Remote version (transmitter): Ex Zone 1, Class I Div. 1

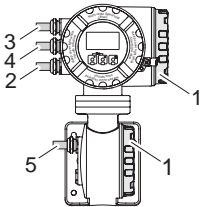

Transmitter connection:

- 1 Connection diagram inside the connection compartment cover
- 2 Power supply cable
- 3 Signal cable or fieldbus cable
- 4 Optional

Connecting cable connection:

- 5 Sensor/transmitter connecting cable

A0012372

3.1.4 Remote version (sensor): non-Ex Zone, Ex Zone 1, Class I Div. 1

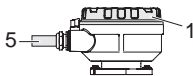

Transmitter connection:

- 1 Connection diagram inside the connection compartment cover

Connecting cable connection:

- 5 Sensor/transmitter connecting cable

A0007548

3.2 Degree of protection

The devices meet all the requirements for IP 67.

After mounting in the field or service work, the following points have to be observed to ensure that IP 67 protection is retained:

- Install the measuring device in such a way that the cable entries do not point upwards.
- Do not remove the seal from the cable entry.
- Remove all unused cable entries and plug them with suitable/certified drain plugs.
- Use cable entries and drain plugs with a continuous service temperature range according to the temperature data on the nameplate.

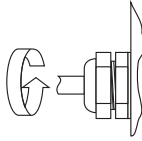

A0007549

Tighten the cable entries correctly.

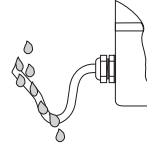

A0007550

The cables must loop down before they enter the cable entries (“water trap”).

3.3 Post-connection check

- Are cables or the device damaged (visual inspection)?
- Does the supply voltage match the information on the nameplate?
- Do the cables used comply with the necessary specifications?
- Do the mounted cables have adequate strain relief and are they routed securely?
- Is the cable type route completely isolated? Without loops and crossovers?
- Are all screw terminals firmly tightened?
- Are all cable entries installed, firmly tightened and correctly sealed?
- Cable routed as a “water trap” in loops?
- Are all the housing covers installed and securely tightened?

In addition, for measuring devices with fieldbus communication:

- Are all the connecting components (T-boxes, junction boxes, connectors etc.) connected with each other correctly?
- Has each fieldbus segment been terminated at both ends with a bus terminator?
- Has the max. length of the fieldbus cable been observed in accordance with the specifications?
- Has the max. length of the spurs been observed in accordance with the specifications?
- Is the fieldbus cable fully shielded and correctly grounded?

4 Hardware settings

This section only deals with the hardware settings needed for commissioning. All other settings (e.g. output configuration, write protection etc.) are described in the associated Operating Instructions on the CD-ROM.



Note!

No hardware settings are needed for measuring devices with HART-type communication.

4.1 Device address

Has to be set for measuring devices with the following communication methods:

- MODBUS RS485

The device address can be configured via:

- Miniature switches → see description below
- Local operation → 20, **Software settings** section

Addressing via miniature switches



Warning!

Risk of electric shock! Risk of damaging the electronic components!

- All the safety instructions for the measuring device must be observed and all the warnings heeded → 10.
- Use a workspace, working environment and tools purposely designed for electrostatically sensitive devices.

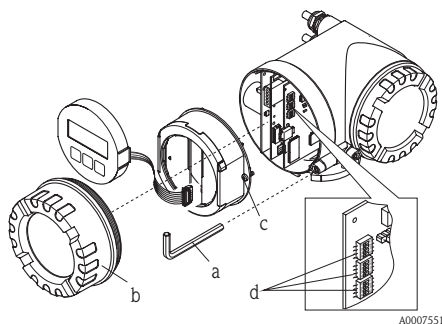

A0007551



Warning!

Switch off the power supply before opening the device.

- a. Loosen the cheese head screw of the securing clamp with an Allen key (3 mm).
- b. Unscrew cover of the electronics compartment from the transmitter housing.
- c. Loosen the securing screws of the display module and remove the onsite display (if present).
- d. Set the position of the miniature switches on the I/O board using a sharp pointed object.

Installation is the reverse of the removal procedure.

MODBUS RS485

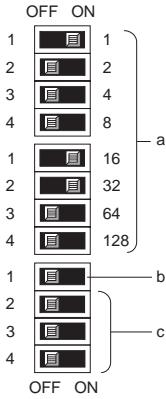

A0007554

Device address range: 1 to 247
 Factory setting: 247

- Miniature switches for device address
 Example shown:
 $1 + 16 + 32 = \text{device address } 49$
- Miniature switches for the address mode (method of addressing):
 - OFF (factory setting) = software addressing via local operation/operating program
 - ON = hardware addressing via miniature switches
- Miniature switch not assigned.

4.2 Terminating resistors



Note!

If the measuring device is used at the end of a bus segment, termination is required. This can be performed in the measuring device by setting the terminating resistors on the I/O board. Generally, however, it is recommended to use an external bus terminator and not perform termination at the measuring device itself.

Has to be set for measuring devices with the following communication methods:

- MODBUS RS485 → Termination can be performed at the measuring device → .



Warning!

Risk of electric shock! Risk of damaging the electronic components!

- All the safety instructions for the measuring device must be observed and all the warnings heeded → 10.
- Use a workspace, working environment and tools purposely designed for electrostatically sensitive devices.

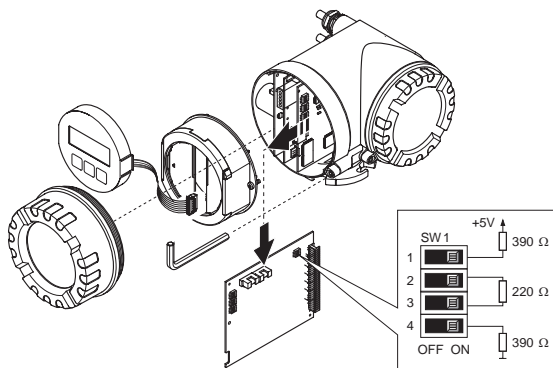

Setting the terminating switch SW1
on the I/O board:
ON - ON - ON - ON

A0007556

5 Commissioning

5.1 Switching on the measuring device

On completion of the installation (successful post-installation check), wiring (successful post-connection check) and after making the necessary hardware settings, where applicable, the permitted power supply (see nameplate) can be switched on for the measuring device.

When the power supply is switched on, the measuring device performs a number of power-up checks and device self-checks. As this procedure progresses the following messages can appear on the onsite display:

Display examples:

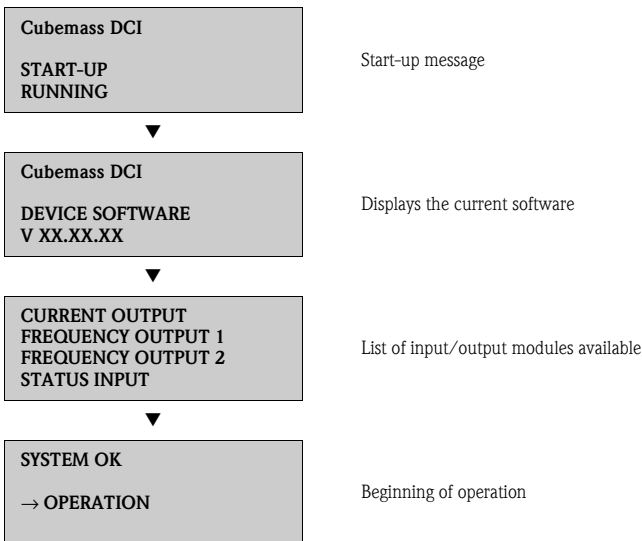

The measuring device starts operating as soon as the startup procedure is complete. Various measured values and/or status variables appear on the display.



Note!

If an error occurs during startup, this is displayed by an error message.

The error messages that occur most frequently when a measuring device is commissioned are described in the Troubleshooting section → [21](#).

5.2 Operation

5.2.1 Display elements

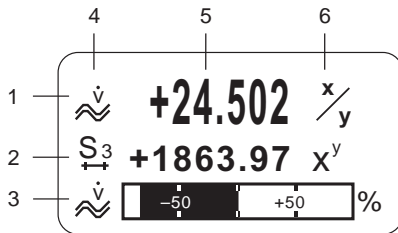

A0007663

Display lines/fields

1. Main line for primary measured values
2. Additional line for additional measured variables/status variables
3. Information line for bar graph display for example
4. Info icons, e.g. volume flow
5. Current measured values
6. Engineering units/time units

5.2.2 Operating elements

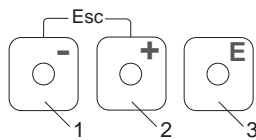

A0007559

Operating keys

1. (-) Minus key for entering, selecting
2. (+) Plus key for entering, selecting
3. Enter key for calling the function matrix, saving

When the +/- keys are pressed simultaneously (Esc):

- Exit the function matrix step-by-step:
- > 3 sec. = cancel data input and return to the measured value display

5.2.3 Displaying error messages

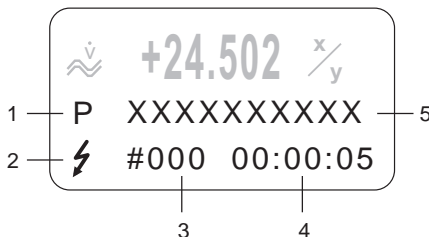

A0007664

1. Type of error:
P = Process error, S = System error
2. Error message type:
⚡ = Fault message, ! = Notice message
3. Error number
4. Duration of the last error that occurred:
Hours: Minutes: Seconds
5. Error designation
 - List of the most common error messages during commissioning → 21
 - List of all error messages → Operating Instructions on the CD-ROM

5.3 Navigating within the function matrix

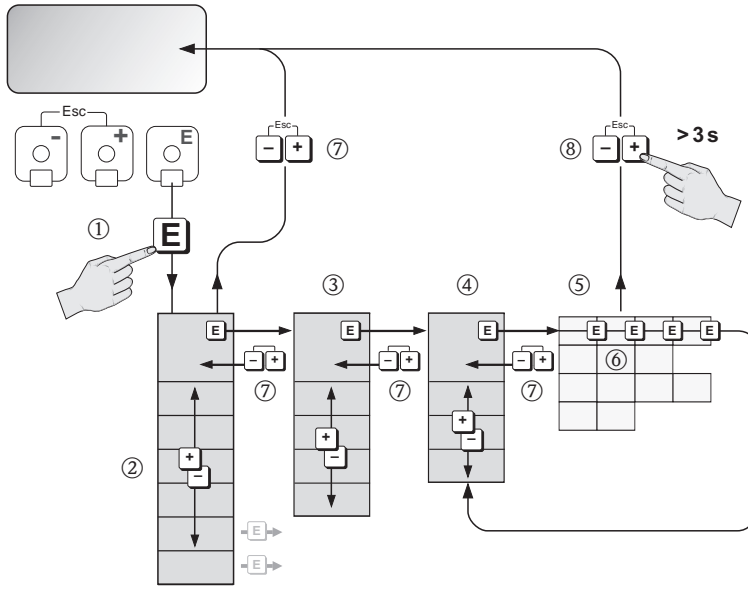













A0007665

1. → Enter the function matrix (starting with measured value display)
2. → Select the Block (e.g. USER INTERFACE)
 → Confirm selection
3. → Select the group (e.g. CONTROL)
 → Confirm selection
4. → Select the function group (e.g. BASIC CONFIGURATION)
 → Confirm selection
5. → Select function (e.g. LANGUAGE)
6. → Enter code **84** (only for the first time you access the function matrix)
 → Confirm entry
 → Change function/selection (e.g. ENGLISH)
 → Confirm selection
7. → Return to measured value display step by step
8. > 3 s → Return immediately to measured value display

5.4 Calling the "Commissioning" Quick Setup

All the functions needed for commissioning are called up automatically with the Quick Setup. The functions can be changed and adapted to the process in question.

1.  → Enter the function matrix (starting with measured value display)
2.  → Select the group QUICK SETUP
 → Confirm selection
3. QUICK SETUP COMMISSIONING function appears.
4. Intermediate step if configuration is blocked:
 → Enter the code **84** (confirm with ) and thus enable configuration
5.  → Go to Commissioning Quick Setup
6.  → Select YES
 → Confirm selection
7.  → Start Commissioning Quick Setup
8. Configure the individual functions/settings:
 - Via -key, select option or enter number
 - Via -key, confirm entry and go to next function
 - Via -key, return to Setup Commissioning function (settings already made are retained)



Note!

Observe the following when performing the Quick Setup:

- Configuration selection: Select the ACTUAL SETTING option
- Unit selection: This is not offered again for selection after configuring a unit
- Output selection: This is not offered again for selection after configuring an output
- Automatic configuration of the display: select YES
 - Main line = Mass flow
 - Additional line = Totalizer 1
 - Information line = Operating/system conditions
- If asked whether additional Quick Setups should be executed: select NO

All the available functions of the measuring device and their configuration options as well as additional Quick Setups, if available, are described in detail in the "Description of Device Parameters" manual. The related Operating Instructions can be found on the CD-ROM.

The measuring device is ready for operation on completion of the Quick Setup.

5.5 Software settings

5.5.1 Device address

Has to be set for measuring devices with the following communication methods:

- MODBUS RS485
Device address range 1 to 247, factory setting 247

The device address can be configured via:













- Miniature switches →  13, **Hardware settings**
- Local operation → see description below



Note!

The COMMISSIONING SETUP must be executed before setting the device address.

Calling the "Communication" Quick Setup

1.  → Enter the function matrix (starting with measured value display)
2.  → Select the group QUICK SETUP
 → Confirm selection
3.  → Select the QUICK SETUP COMMUNICATION function
4. Intermediate step if configuration is blocked:
 → Enter the code **84** (confirm with ) and thus enable configuration
5.  → Go to Communication Quick Setup
6.  → Select YES
 → Confirm selection
7.  → Start Communication Quick Setup
8. Configure the individual functions/settings:
 - Via -key, select option or enter number
 - Via -key, confirm entry and go to next function
 - Via -key, return to Setup Commissioning function
(settings already made are retained)

All the available functions of the measuring device and their configuration options as well as additional Quick Setups, if available, are described in detail in the "Description of Device Parameters" manual. The related Operating Instructions can be found on the CD-ROM.

The measuring device is ready for operation on completion of the Quick Setup.

5.6 Troubleshooting

The error messages that can occur most frequently when a measuring device is commissioned are described here.

A complete description of all the error messages → Operating Instructions on the CD-ROM.

HART

No.	Error message / Type	Cause/remedy
351 to 354	System error message (S)/ Notice message (!) CURRENT SPAN n # 351 to 354	Current output The current flow is outside the set range. 1. Change the upper range or lower range values entered 2. Increase or reduce flow, as applicable
701	Process error message (P)/ Notice message (!) EXC. CURR. LIM. # 701	The maximum current value for the measuring tube exciter coils has been reached since certain fluid characteristics, e.g. high gas or solid content, are in the limit range. The device continues to work correctly. In particular with outgassing fluids and/or increased gas content, the following measures are recommended to increase system pressure: 1. Install the measuring device downstream of a pump 2. Mount the device at the lowest point in an ascending pipeline 3. Install a valve or an orifice plate downstream from the measuring device

MODBUS RS485

Register 6859 Data type: Integer	Register 6821 Data type: String (18 byte)	No.	Error message / Type	Cause/remedy
39 to 42	RANGE CUR. OUT n	351 to 354	System error message (S)/ Notice message (!) CURRENT SPAN n # 351 to 354	See HART table
112	EXC. CURR. LIM	701	Process error message (P)/ Notice message (!) EXC. CURR. LIM. # 701	See HART table

www.endress.com/worldwide

Endress+Hauser 
People for Process Automation
