

Quick Start-up Guide

Integra OUM910/ OUSAF12

Analyzer/Sensor to measure Solid Concentration

This guide is intended to provide quick guidance and help to perform a basic instrument start-up.

For detailed references please consult the appropriate operational manual.

Table of Contents

| | |
|---|----|
| 1. Safety Instructions | 4 |
| 2. Termination of Measurement Cable | 5 |
| 3. Monitor Front Panels and Controls | 6 |
| 4. Operation Legend | 7 |
| 5. User Software Diagram and Description - General Description | 8 |
| 6. Initial Start-up | 9 |
| 7. Quick Start Procedure | 10 |

1. Safety Instructions

Please ensure that all electrical connections are connected properly according to Figure 1-3 before performing the instrument start-up. Please also ensure that the lamp voltage is set to the value stated on the instrument test sheet.

Lamp voltage would be preset by the factory before shipping the system and should not require adjustment, however if the system has been installed by non qualified personnel please check the lamp voltage. The lamp voltage should be measured between **Sense + and Sense -** (see Figure 3). Factory lamp voltage data can be found on the instrument test sheet supplied with the instrument.

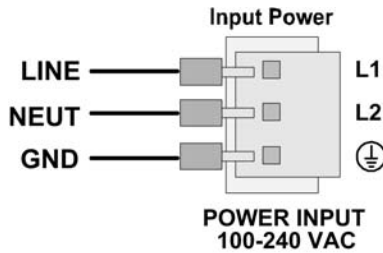

Figure 1 - Model 910 Wiring Diagram (AC Input Version)

For instruments supplied for 24VDC operation, only the power input connection is changed. Figure 2 shows the connection detail for a 24VDC unit.

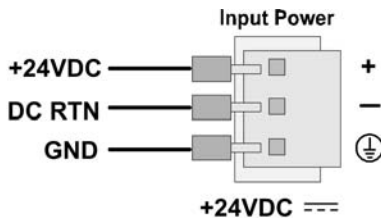

Figure 2 - Model 910 Wiring Diagram (DC Input Version)

2. Termination of Measurement Cable

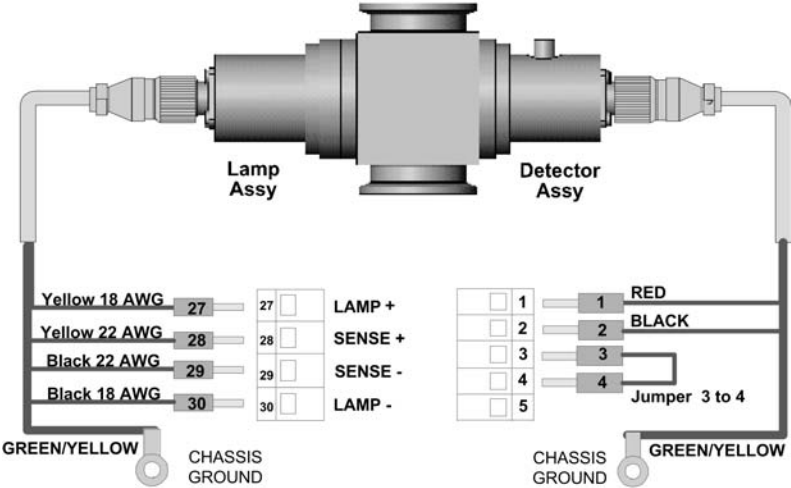

Figure 3 - OUSAF12 In-line Sensor Wiring Diagram (AC Input Version)

Notes on safety icons and symbols

Safety icons



Warning!

This symbol alerts you to hazards. They can cause serious damage to the instrument or to persons if ignored.



Note!

This symbol indicates important items of information.

3. Monitor Front Panels and Controls

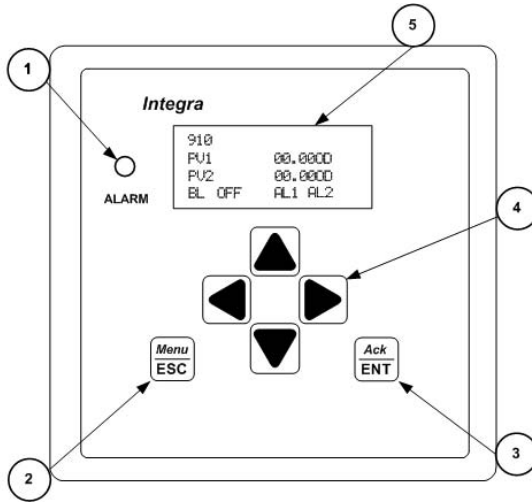

Figure 4 - Model 910 Front Panel

The front panel of the Model 910 monitor is shown in Figure 4. A brief description of the features is as follows:

- ① The Alarm LED indicator illuminates when one of the alarm conditions exists. The Lamp Fail, Alarm 1 and 2, and the Cable Fault alarms will trigger the LED.
- ② The Menu/Esc key serves two functions. Pressing Menu/Esc will always exit out of a screen (back out) and will not save any changes entered. Pressing Menu/Esc from the main PV or Output screen will open the Sub-Menu screen.
- ③ The Ack/Ent key will accept changes in a screen and continue forward through the screen.
- ④ The up/down and left/right keys navigate the user through the menus and screens. Active keys are identified by small back-to-back arrows (▲▼ up/down) (◀▶ left/right) in the display to indicate movement through the screen. Highlighted and blinking cursors are also used to identify parameters that may be changed.
- ⑤ The LCD display is a backlit 4 line by 20 character type. All programming may be done through this interface. Alarm and status messages appear on the bottom line while in the PV or Output screen.

4. Operation Legend

In this quick guide, the following operation legend will be used when describing operation procedure.



Enter/Acknowledge Key



Escape/Menu Key



Left or Right Key



Up or Down Key



5. User Software Diagram and Description - General Description

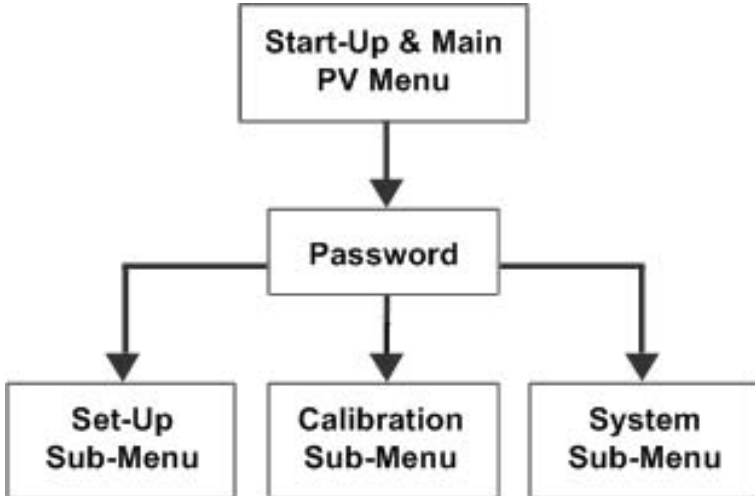

The Model 910 software consists of three levels. The Main PV/Output (Process Variable/Current Output) Screens, The Process Control/Calibration Check Screens (Privileged), and the Configuration Sub-Menu (Password Protected).

The following diagrams and descriptions will identify and describe the various display screens and functions. Menus are activated by pressing the Menu/Esc key. Selections, changes, and acknowledgements are activated by pressing the Ack/Ent key. Cursors and parameter changes are activated by using the up/down, and left/right keys.

All user input changes are prompted with an "Are you sure?" acknowledge prompt. A press of the Menu/Esc key will always exit out of a screen (back out) and will not save any changes entered. A press of the Ack/Ent key will accept changes, and continue forward through the display screen sequence.

6. Initial Start-up

Upon initial start-up, ensure the unit is properly connected; refer to figure 1-3 for proper wiring diagrams. If the lamp power is not "On" apply power through the Process Control screen and allow to warm up for 30 minutes.

If Password Protection is enabled the Process Control Screen is restricted to authorized users. Refer to the manual for further information about Password Protection.

Use the left/right keys to open the Process Control Screen. Use the up/down keys to select Lamp and select "On" with the left/right keys. If the lamp power was previously "On" when a power interruption occurs, the monitor will retain its last state and return to that setting when power is restored.

7. Quick Start Procedure



The quick start-up consists of two steps. Step 1 defining the 4-20mA output span and Step 2 zero calibration of the system with the sensor filled with DI water.

Always start from the main process screen:

| | |
|------------------------------------|-------------------------|
| <Transmitter Label> | <Over Range Sign> |
| P V 1 : X . X X X X <Process Unit> | |
| P V 2 : X . X X X X <Process Unit> | |
| <BaseLine Status> | <Alarm and Lamp Status> |

Step 1: Change output span

- Press



- Press



to move to Process set-up sub menu and press



- Press



to move to **Setup: Output Span** and press



- Press



to select output

| | | | |
|-----------------------------------|---|---------------------|--|
| S E T U P : O U T P U T S P A N S | | | |
| O 1 | █ | ± X X . X % | |
| O 2 | █ | ± X X . X % | |
| E S C / E X I T | | E N T / S E L E C T | |



- Press



to move the cursor

- Press  to change the **value** of the span for desired range.





- Press  twice to accept the change of the span.

- Repeat above steps for output two if needed.

Step 2: Set zero of the system

- Fill the sensor with DI water

- From main process screen press left   to go to **Proc control** screen

- Press  to scroll to **Optical Zero**



- Press  twice with the flow filled with DI and the system will read zero.



System is now ready for use.

Before using the factory default function please contact the factory for guidance.

www.wedgewoodanalytical.com

