



Level



Pressure



Flow



Temperature



Liquid  
Analysis



Registration



Systems  
Components



Services



Solutions

## Brief Operating Instructions

# Proline Promag 51

Electromagnetic Flow Measuring System  
For Custody Transfer with Cold Water

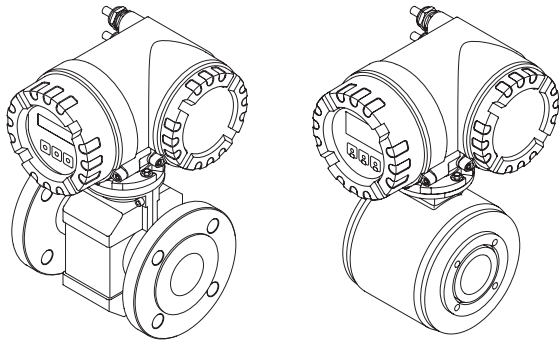

These Brief Operating Instructions are **not** intended to replace the Operating Instructions provided in the scope of supply. Detailed information is provided in the Operating Instructions and the additional documentation on the CD-ROM supplied.

The complete device documentation consists of:

- These Brief Operating Instructions
- Depending on the device version:
  - Operating Instructions and the Description of Device Functions
  - Approvals and safety certificates
  - Special safety instructions in accordance with the approvals for the device (e.g. explosion protection, pressure equipment directive etc.)
  - Additional device-specific information

# Table of contents

<b>1</b>	<b>Safety instructions</b>	<b>3</b>
1.1	Designated use	3
1.2	Installation, commissioning and operation	3
1.3	Operational safety	3
1.4	Safety conventions	5
<b>2</b>	<b>Installation</b>	<b>6</b>
2.1	Transporting to the measuring point	6
2.2	Installation conditions	7
2.3	Installing the Promag W sensor	12
2.4	Installing the Promag P sensor	13
2.5	Tightening torques for Promag W and Promag P	14
2.6	Installing the transmitter housing	16
2.7	Post-installation check	18
<b>3</b>	<b>Wiring</b>	<b>19</b>
3.1	Connecting the various housing types	20
3.2	Connecting the remote version connecting cable	21
3.3	Potential equalization	23
3.4	Degree of protection	24
3.5	Post-connection check	24
<b>4</b>	<b>Commissioning</b>	<b>25</b>
4.1	Switching on the measuring device	25
4.2	Operation	26
4.3	Navigating within the function matrix	27
4.4	Calling the Commissioning Quick Setup	28
4.5	Custody transfer measurement	29
4.6	Troubleshooting	30

# 1 Safety instructions

## 1.1 Designated use

- The measuring device is to be used only for measuring the flow of conductive liquids in closed pipes. A minimum conductivity of 20  $\mu\text{S}/\text{cm}$  is required for measuring demineralized water. Most liquids can be measured as of a minimum conductivity of 5  $\mu\text{S}/\text{cm}$ .
- Any use other than that described here compromises the safety of persons and the entire measuring system and is, therefore, not permitted.
- The manufacturer is not liable for damage caused by improper or non-designated use.

## 1.2 Installation, commissioning and operation

- The measuring device must only be installed, connected, commissioned and maintained by qualified and authorized specialists (e.g. electrical technicians) in full compliance with the instructions in these Brief Operating Instructions, the applicable norms, legal regulations and certificates (depending on the application).
- The specialists must have read and understood these Brief Operating Instructions and must follow the instructions they contain. If you are unclear on anything in these Brief Operating Instructions, you must read the Operating Instructions (on the CD-ROM). The Operating Instructions provide detailed information on the measuring device.
- The measuring device should only be installed in a de-energized state free from outside loads or strain.
- The measuring device may only be modified if such work is expressly permitted in the Operating Instructions (on the CD-ROM).
- Repairs may only be performed if a genuine spare parts kit is available and this repair work is expressly permitted.
- If performing welding work on the piping, the welding unit may not be grounded by means of the measuring device.

## 1.3 Operational safety



- The measuring device is designed to meet state-of-the-art safety requirements, has been tested, and left the factory in a condition in which it is safe to operate. Relevant regulations and European standards have been observed.
- The manufacturer reserves the right to modify technical data without prior notice. Your Endress+Hauser distributor will supply you with current information and updates to these Operating Instructions.
- The information on the warning notices, nameplates and connection diagrams affixed to the device must be observed. These contain important data on the permitted operating conditions, the range of application of the device and information on the materials used.
- If the device is not used at atmospheric temperatures, compliance with the relevant marginal conditions as specified in the device documentation supplied (on CD-ROM) is mandatory.
- The device must be wired as specified in the wiring and connection diagrams. Interconnection must be permitted.

- All parts of the device must be included in the potential equalization of the system.
- Cables, certified cable glands and certified dummy plugs must be suitable to withstand the prevailing operating conditions, such as the temperature range of the process. Housing apertures that are not used must be sealed with dummy plugs.
- The device should only be used for fluids to which all the wetted parts of the device are sufficiently resistant. With regard to special fluids, including fluids used for cleaning, Endress+Hauser will be happy to assist in clarifying the corrosion-resistant properties of wetted materials.

However, minor changes in temperature, concentration or in the degree of contamination in the process may result in variations in corrosion resistance.

For this reason, Endress+Hauser does not accept any responsibility with regard to the corrosion resistance of wetted materials in a specific application. The user is responsible for the choice of suitable wetted materials in the process.

- Hazardous areas

Measuring devices for use in hazardous areas are labeled accordingly on the nameplate. Relevant national regulations must be observed when operating the device in hazardous areas. The Ex documentation on the CD-ROM is an integral part of the entire device documentation. The installation regulations, connection data and safety instructions provided in the Ex documentation must be observed. The symbol and name on the front page provides information on the approval and certification (e.g.  Europe,  USA,  Canada). The nameplate also bears the documentation number of this Ex documentation (XA\*\*\*D/.../..).

- For measuring systems used in SIL 2 applications, the separate manual on functional safety (on the CD-ROM) must be observed.

- Hygienic applications

Measuring devices for hygienic applications have their own special labeling. Relevant national regulations must be observed when using these devices.

- Pressure instruments

Measuring devices for use in systems that need to be monitored are labeled accordingly on the nameplate. Relevant national regulations must be observed when using these devices. The documentation on the CD-ROM for pressure instruments in systems that need to be monitored is an integral part of the entire device documentation. The installation regulations, connection data and safety instructions provided in the Ex documentation must be observed.

- Endress+Hauser will be happy to assist in clarifying any questions on approvals, their application and implementation.

## 1.4 Safety conventions



Warning!

"Warning" indicates an action or procedure which, if not performed correctly, can result in injury or a safety hazard. Comply strictly with the instructions and proceed with care.



Caution!

"Caution" indicates an action or procedure which, if not performed correctly, can result in incorrect operation or destruction of the device. Comply strictly with the instructions.



Note!

"Note" indicates an action or procedure which, if not performed correctly, can have an indirect effect on operation or trigger an unexpected response on the part of the device.

## 2 Installation

### 2.1 Transporting to the measuring point

- Transport the measuring device to the measuring point in the original packaging.
- Do not remove the covers or caps until immediately before installation.

#### 2.1.1 Transporting flanged devices $DN \leq 300$ ( $\leq 12''$ )

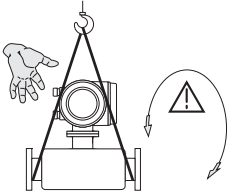

A0007408

To transport the unit, use slings slung around the process connections or use lugs (if available).

**Warning!**  
Risk of injury! The device can slip.  
The center of gravity of the measuring device may be higher than the holding points of the slings.  
Always ensure that the device cannot slip or turn around its axis.

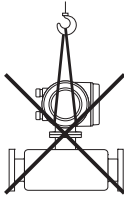

A0007409

Do not lift measuring devices by the transmitter housing or the connection housing in the case of the remote version. Do not use chains as they could damage the housing.

#### 2.1.2 Transporting flanged devices $DN > 300$ ( $> 12''$ )

Use only the metal eyes provided on the flanges to transport, lift or position the sensor in the piping.

**Caution!**

Do not attempt to lift the sensor with the tines of a fork-lift truck beneath the metal casing! This would buckle the casing and damage the internal magnetic coils.

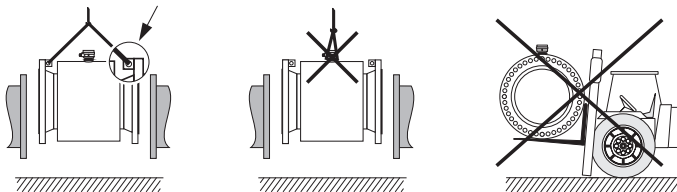

A0008153

## 2.2 Installation conditions

### 2.2.1 Dimensions

For the dimensions of the measuring device, see the associated Technical Information on the CD-ROM.

### 2.2.2 Mounting location

The accumulation of air or formation of gas bubbles in the measuring tube can result in an increase in measuring errors.

For this reason **avoid** the following mounting locations in the pipe:

- At the highest point of a pipeline. Risk of air accumulating!
- Directly upstream from a free pipe outlet in a down pipe.

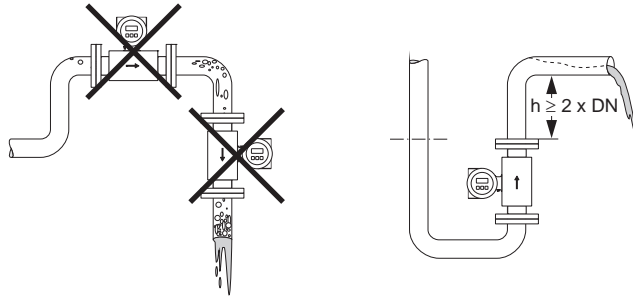

A0008154

### Installation of pumps

Do not install the sensor on the intake side of a pump. This precaution is to avoid low pressure and the consequent risk of damage to the lining of the measuring tube. It might be necessary to use pulse dampers in systems incorporating piston pumps, piston diaphragm pumps or peristaltic pumps.

Information on the measuring system's pressure tightness and resistance to vibration and shock can be found in the Operating Instructions of the CD-ROM.

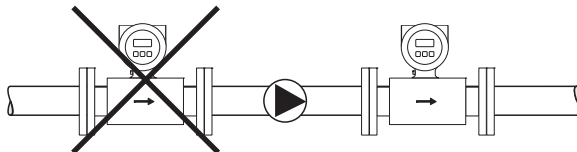

A0003203

## Partially filled pipes

Partially filled pipes with gradients necessitate a drain-type configuration.

The empty pipe detection (EPD) function offers additional protection by detecting empty or partially filled pipes.

- ☞ **Caution!**  
Risk of solids accumulating! Do not install the sensor at the lowest point in the drain. It is advisable to install a cleaning valve.

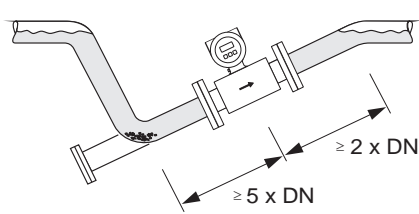

Installation in a partially filled pipe

A0008155

## Down pipes

Install a siphon or a vent valve downstream of the sensor in down pipes longer than 5 meters (16 ft). This precaution is to avoid low pressure and the consequent risk of damage to the lining of the measuring tube. This measure also prevents the system losing prime, which could cause air pockets.

For information on the pressure tightness of the measuring tube lining, see the Operating Instructions on the CD-ROM.

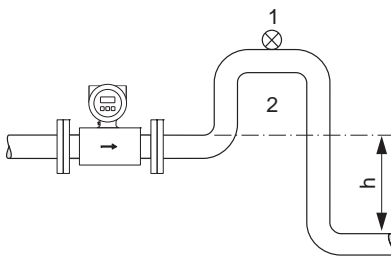

Measures for installation in a down pipe ( $h > 5 \text{ m}/16 \text{ ft}$ )

1. Vent valve
2. Siphon

A0008157



### 2.2.3 Orientation

An optimum orientation helps avoid gas and air accumulations and buildup in the measuring tube. The measuring device, nevertheless, supplies a range of functions and tools to measure problematic fluids correctly:

- Electrode cleaning circuitry (ECC) to prevent electrically conductive deposits in the measuring tube, e.g. for fluids causing buildup
- Empty pipe detection (EPD) for detecting partially filled measuring tubes, e.g. in the case of degassing fluids or varying process pressures
- Exchangeable measuring electrodes for abrasive fluids (only Promag W)

#### Vertical orientation

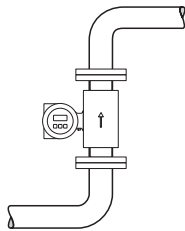

This orientation is optimum for self-emptying piping systems and when using empty pipe detection (EPD) or open electrode detection (OED).

A0008158

#### Horizontal orientation

The measuring electrode plane should be horizontal. This prevents brief insulation of the two electrodes by entrained air bubbles.

 Caution!

In the case of horizontal orientation, empty pipe detection only works correctly if the transmitter housing is facing upwards. Otherwise there is no guarantee that empty pipe detection will respond if the measuring tube is only partially filled or empty.

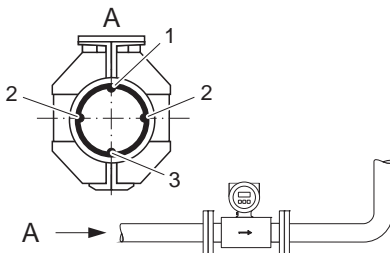

1. EPD electrode for empty pipe detection
2. Measuring electrodes for signal detection
3. Reference electrode for potential equalization

A0008159

### Inlet and outlet runs

If possible, install the sensor upstream from fittings such as valves, T-pieces, elbows, etc.

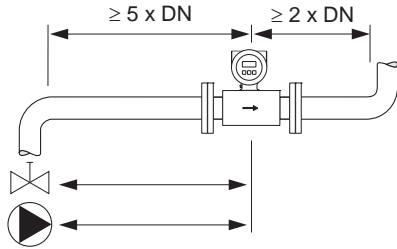

A0008160

The following inlet and outlet runs must be observed in order to meet accuracy specifications:

- Inlet run:  $\geq 5 \times \text{DN}$
- Outlet run:  $\geq 2 \times \text{DN}$

### 2.2.4 Vibrations

Secure and fix both the piping and the sensor if vibrations are severe.

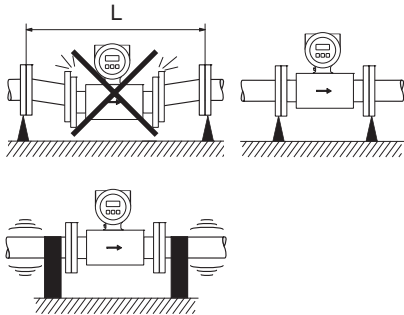

A0008161

Measures to prevent device vibration  
( $L > 10 \text{ m}/33 \text{ ft}$ )



**Caution!**

It is advisable to install the sensor and transmitter separately if vibration is excessively severe. For information on the permitted shock and vibration resistance, see the Operating Instructions on the CD-ROM.

### 2.2.5 Foundations, supports

If the nominal diameter is  $DN \geq 350$  ( $\geq 14''$ ), mount the sensor on a foundation of adequate load-bearing strength.



Caution!

Risk of damage! Do not support the weight of the sensor on the metal casing. This would buckle the casing and damage the internal magnetic coils.

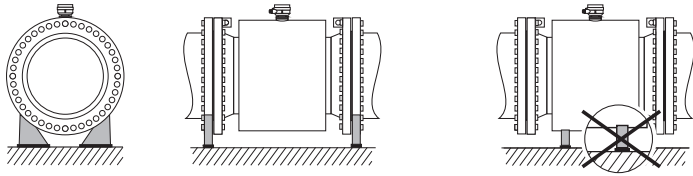

A0008163

### 2.2.6 Length of connecting cable

Comply with the following instructions in order to ensure correct measuring results:

- Secure the cable run or route the cable in an armored conduit. Movement of the cable can falsify the measuring signal, particularly if the fluid conductivity is low.
- Route the cable well clear of electrical machines and switching elements.
- Ensure potential equalization between the sensor and transmitter, if necessary.
- The permissible cable length  $L_{max}$  depends on the fluid conductivity.

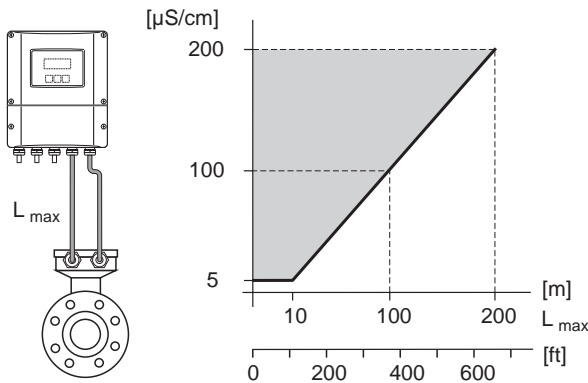

Gray shaded area = permissible range

$L_{max}$  = length of connecting cable in [m]/[ft]

Fluid conductivity in  $[\mu\text{S}/\text{cm}]$

A0008164

## 2.3 Installing the Promag W sensor

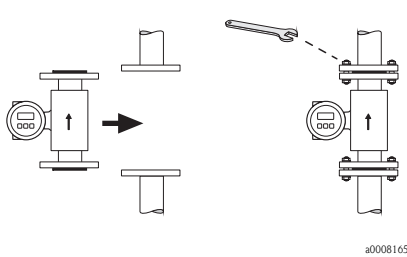

### Note!

Screws, nuts, seals, etc. are not included in the scope of supply and must be supplied by the customer.

The sensor is installed between the two pipe flanges:

- The requisite torques must be observed  
→ Page 14 ff.
- Observe the accompanying mounting instruction if ground discs are used.
- To comply with the device specification, a concentric installation in the measuring section is required

### 2.3.1 Seals

Comply with the following instructions when installing seals:

- Hard rubber lining → additional seals are **always** required!
- Polyurethane lining → **No** seals are required.
- For DIN flanges, only use seals to DIN EN 1514-1.
- Make sure that the mounted seals do not protrude into the piping cross-section.



### Caution!

Risk of short circuit!

Do not use electrically conductive sealing compounds such as graphite! An electrically conductive layer could form on the inside of the measuring tube and short-circuit the measuring signal.

### 2.3.2 Ground cable

If necessary, special ground cables can be ordered as accessories for potential equalization.

## 2.4 Installing the Promag P sensor

### ⚠ Caution!

- The plates mounted on the two sensor flanges protect the PTFE which is turned over the flanges and, consequently, should not be removed until immediately prior to mounting the sensor.
- The protective plates must always remain mounted while the device is in storage.
- Make sure that the lining at the flange is not damaged or removed.

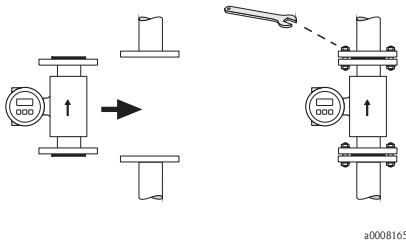

### Note!

Screws, nuts, seals, etc. are not included in the scope of supply and must be supplied by the customer.

The sensor is installed between the two pipe flanges:

- The requisite torques must be observed  
→ Page 14 ff.
- Observe the accompanying mounting instruction if ground discs are used.

a0008165

### 2.4.1 Seals

Comply with the following instructions when installing seals:

- **No** seals are required for PFA or PFTE measuring tube lining.
- For DIN flanges, only use seals to DIN EN 1514-1.
- Make sure that the mounted seals do not protrude into the piping cross-section.

### ⚠ Caution!

Risk of short circuit! Do not use electrically conductive sealing compounds such as graphite! An electrically conductive layer could form on the inside of the measuring tube and short-circuit the measuring signal.

### 2.4.2 Ground cable

If necessary, special ground cables can be ordered as accessories for potential equalization.

## 2.5 Tightening torques for Promag W and Promag P

- The tightening torques listed below are for lubricated threads only.
- Always tighten the screws uniformly and in diagonally opposite sequence.
- Overtightening the screws will deform the sealing faces or damage the seals.
- The values listed below apply only to pipes not subjected to tensile stress.

### 2.5.1 Tightening torques for pressure ratings in accordance with EN (DIN)

Nominal diameter [mm]	EN (DIN) Pressure rating [bar]	Screws	Max. tightening torque [Nm]			
			Promag W		Promag P	
			Hard rubber	Polyurethane	PTFE	PFA
15	PN 40	4 x M 12	–	–	11	–
25	PN 40	4 x M 12	–	15	26	20
32	PN 40	4 x M 16	–	24	41	35
40	PN 40	4 x M 16	–	31	52	47
50	PN 40	4 x M 16	–	40	65	59
65 *	PN 16	8 x M 16	32	27	43	40
65	PN 40	8 x M 16	32	27	43	40
80	PN 16	8 x M 16	40	34	53	48
80	PN 40	8 x M 16	40	34	53	48
100	PN 16	8 x M 16	43	36	57	51
100	PN 40	8 x M 20	59	50	78	70
125	PN 16	8 x M 16	56	48	75	67
125	PN 40	8 x M 24	83	71	111	99
150	PN 16	8 x M 20	74	63	99	85
150	PN 40	8 x M 24	104	88	136	120
200	PN 10	8 x M 20	106	91	141	101
200	PN 16	12 x M 20	70	61	94	67
200	PN 25	12 x M 24	104	92	138	105
250	PN 10	12 x M 20	82	71	110	–
250	PN 16	12 x M 24	98	85	131	–
250	PN 25	12 x M 27	150	134	200	–
300	PN 10	12 x M 20	94	81	125	–
300	PN 16	12 x M 24	134	118	179	–
300	PN 25	16 x M 27	153	138	204	–
350	PN 10	16 x M 20	112	118	188	–
350	PN 16	16 x M 24	152	165	254	–
350	PN 25	16 x M 30	227	252	380	–
400	PN 10	16 x M 24	151	167	260	–
400	PN 16	16 x M 27	193	215	330	–
400	PN 25	16 x M 33	289	326	488	–

Nominal diameter [mm]	EN (DIN) Pressure rating [bar]	Screws	Max. tightening torque [Nm]			
			Promag W		Promag P	
			Hard rubber	Polyurethane	PTFE	PFA
450	PN 10	20 x M 24	153	133	235	–
450	PN 16	20 x M 27	198	196	300	–
450	PN 25	20 x M 33	256	253	385	–
500	PN 10	20 x M 24	155	171	265	–
500	PN 16	20 x M 30	275	300	448	–
500	PN 25	20 x M 33	317	360	533	–
600	PN 10	20 x M 27	206	219	345	–
600 *	PN 16	20 x M 33	415	443	658	–
600	PN 25	20 x M 36	431	516	731	–
700	PN 10	24 x M 27	246	246	–	–
700	PN 16	24 x M 33	278	318	–	–
700	PN 25	24 x M 39	449	507	–	–
800	PN 10	24 x M 30	331	316	–	–
800	PN 16	24 x M 36	369	385	–	–
800	PN 25	24 x M 45	664	721	–	–
900	PN 10	28 x M 30	316	307	–	–
900	PN 16	28 x M 36	353	398	–	–
900	PN 25	28 x M 45	690	716	–	–
1000	PN 10	28 x M 33	402	405	–	–
1000	PN 16	28 x M 39	502	518	–	–
1000	PN 25	28 x M 52	970	971	–	–
1200	PN 6	32 x M 30	319	299	–	–
1200	PN 10	32 x M 36	564	568	–	–
1200	PN 16	32 x M 45	701	753	–	–
1400	PN 6	36 x M 33	430	398	–	–
1400	PN 10	36 x M 39	654	618	–	–
1400	PN 16	36 x M 45	729	762	–	–
1600	PN 6	40 x M 33	440	417	–	–
1600	PN 10	40 x M 45	946	893	–	–
1600	PN 16	40 x M 52	1007	1100	–	–
1800	PN 6	44 x M 36	547	521	–	–
1800	PN 10	44 x M 45	961	895	–	–
1800	PN 16	44 x M 52	1108	1003	–	–
2000	PN 6	48 x M 39	629	605	–	–
2000	PN 10	48 x M 45	1047	1092	–	–
2000	PN 16	48 x M 56	1324	1261	–	–

\* Designed in accordance with EN 1092-1 (not to DIN 2501)

## 2.6 Installing the transmitter housing

### 2.6.1 Turning the transmitter housing

#### Turning the aluminum field housing

Aluminum field housing for non-Ex area

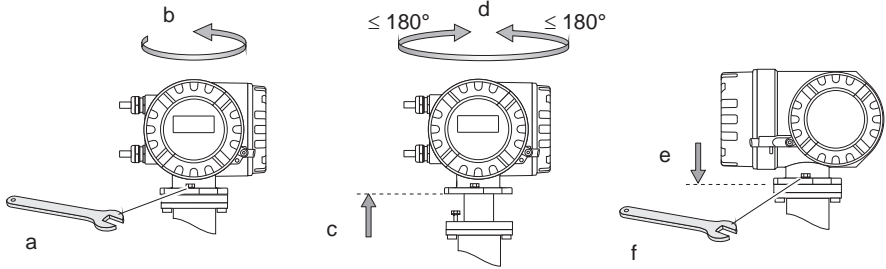

A0007540

Aluminum field housing for Zone 1 or Class I Div. 1

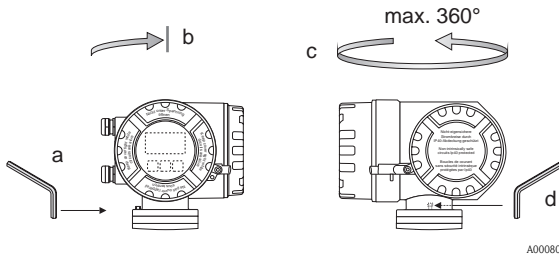

A0008036

For Zone 1 or Class I Div. 1:

- Release the setscrew.
- Turn the transmitter housing gently clockwise until the stop (end of the thread).
- Turn the transmitter counterclockwise (max. 360°) to the desired position.
- Retighten the setscrew.

### 2.6.2 Turning the onsite display

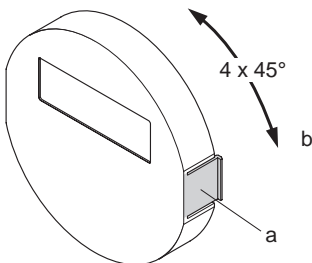

A0007541

- Press in the side latches on the display module and remove the module from the cover plate of the electronics compartment.
- Turn the display to the desired position (max. 4 x 45° in both directions) and reset it onto the cover plate of the electronics compartment.



### 2.6.3 Installing the wall-mount housing



Caution!

- Make sure that the ambient temperature does not exceed the permitted range.
- Always install the wall-mount housing in such a way that the cable entries point downwards.

#### Mounted directly on the wall

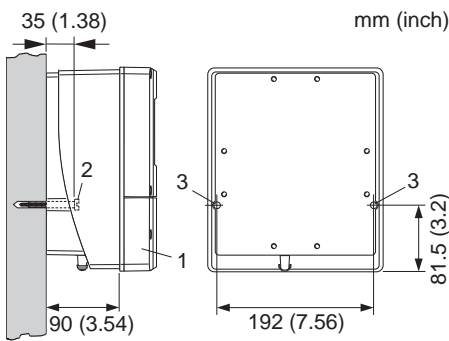

1. Connection compartment
2. Securing screws M6 (max.  $\varnothing$  6.5 mm (0.25"); screw head max.  $\varnothing$  10.5 mm (0.4")
3. Housing bores for securing screws

A0007542-ae

#### Pipe mounting

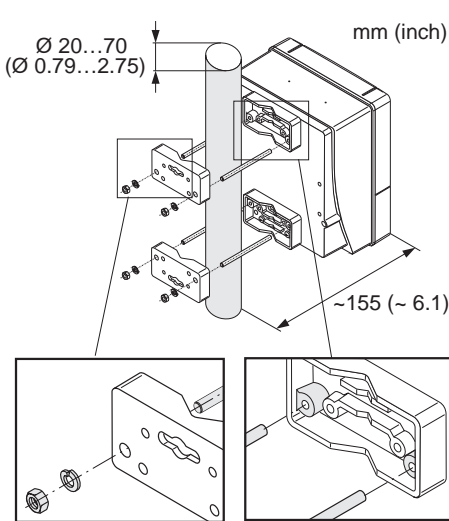

Caution!

Danger of overheating! If the device is mounted on a warm pipe, make sure that the housing temperature does not exceed +60 °C (+140 °F) which is the maximum temperature permitted.

A0007543-ae

## Panel mounting

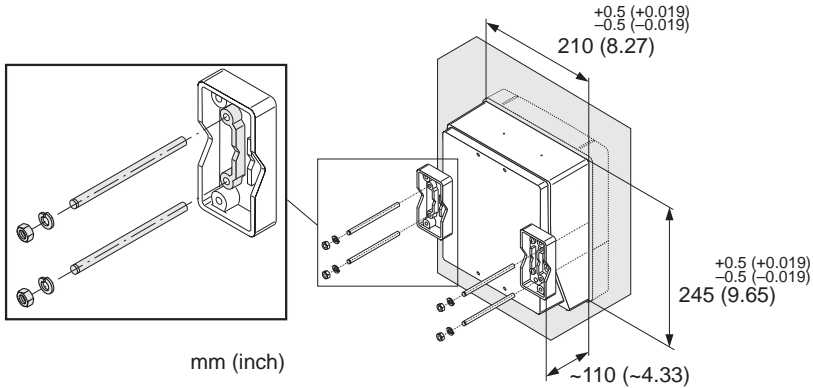

A0007544-ae

## 2.7 Post-installation check

- Is the measuring device damaged (visual inspection)?
- Does the device correspond to specifications at the measuring point, including process temperature and pressure, ambient temperature, minimum fluid conductivity, measuring range, etc.?
- Does the arrow on the sensor nameplate match the actual direction of flow through the pipe?
- Is the position of the measuring electrode plane correct?
- Is the position of the empty pipe detection electrode correct?
- Were all screws tightened to the specified torques when the sensor was installed?
- Were the correct seals used (type, material, installation)?
- Are the measuring point number and labeling correct (visual inspection)?
- Were the inlet and outlet runs respected?
  - Inlet run  $\geq 5 \times \text{DN}$
  - Outlet run  $\geq 2 \times \text{DN}$
- Is the measuring device protected against moisture and direct sunlight?
- Is the sensor adequately protected against vibration (attachment, support)?  
Acceleration up to 2 g by analogy with IEC 600 68-2-8

### 3 Wiring



#### Warning!

Risk of electric shock! Components carry dangerous voltages.

- Never mount or wire the measuring device while it is connected to the power supply.
- Before connecting the power supply, check the safety equipment.
- Route the power supply and signal cables so they are securely seated.
- Seal the cable entries and covers tight.



#### Caution!

Risk of damaging the electronic components!

- Connect the power supply in accordance with the connection data on the nameplate.
- Connect the signal cable in accordance with the connection data in the Operating Instructions or the Ex documentation on the CD-ROM.

#### **In addition, for the remote version:**



#### Caution!

Risk of damaging the electronic components!

- Only connect sensors and transmitters with the same serial number.
- Observe the cable specifications of the connecting cable → Operating Instructions on the CD-ROM.



#### Note!

Install the connecting cable securely to prevent movement.

#### **In addition, for Ex-certified measuring devices:**



#### Warning!

When wiring Ex-certified measuring devices, all the safety instructions, wiring diagrams, technical information etc. of the related Ex documentation must be observed  
→ Ex documentation on the CD-ROM.

### 3.1 Connecting the various housing types

Wire the unit using the terminal assignment diagram inside the cover.

#### 3.1.1 Compact version

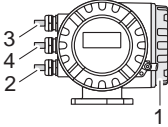

A0007545

Transmitter connection:

- 1 Connection diagram inside the connection compartment cover
- 2 Power supply cable
- 3 Signal cable or fieldbus cable
- 4 Optional

#### 3.1.2 Remote version (transmitter): non-Ex Zone

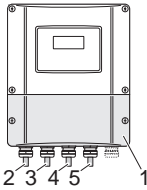

A0007546

Transmitter connection:

- 1 Connection diagram inside the connection compartment cover
- 2 Power supply cable
- 3 Signal cable
- 4 Fieldbus cable

Connecting the connecting cable (→ Page 21 ff.):

- 5 Sensor/transmitter connecting cable

#### 3.1.3 Remote version (transmitter): Ex Zone 1

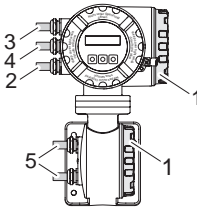

A0008218

Transmitter connection:

- 1 Connection diagram inside the connection compartment cover
- 2 Power supply cable
- 3 Signal cable or fieldbus cable
- 4 Optional

Connecting the connecting cable (→ Page 21 ff.):

- 5 Sensor/transmitter connecting cable

#### 3.1.4 Remote version (sensor)

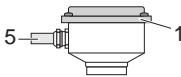

A0008037

Transmitter connection:

- 1 Connection diagram inside the connection compartment cover

Connecting cable connection:

- 5 Sensor/transmitter connecting cable

## 3.2 Connecting the remote version connecting cable

### 3.2.1 Connecting cable for Promag W and P

#### Connecting cable termination

Terminate the signal and coil current cables as shown in the figure below (Detail A).  
Fit the fine-wire cores with cable end ferrules (Detail B).

#### Signal cable termination

Make sure that the cable end ferrules do not touch the wire shields on the sensor side! Minimum distance = 1 mm (0.04 in), exception "GND" = green cable.

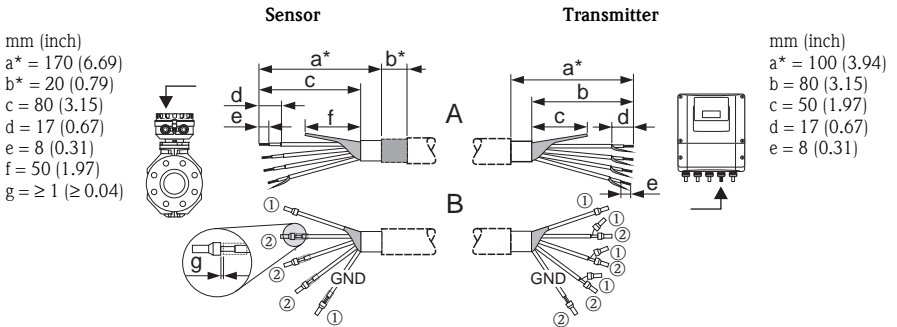

#### Coil current cable termination

Insulate one core of the three-core cable at the level of the core reinforcement; you only require two cores for the connection.

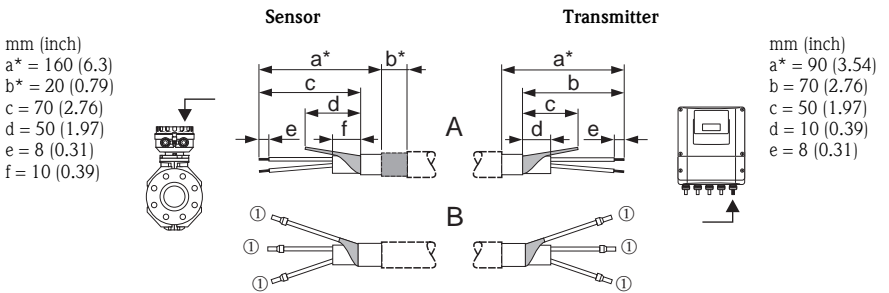

### 3.2.2 Connecting cable connection

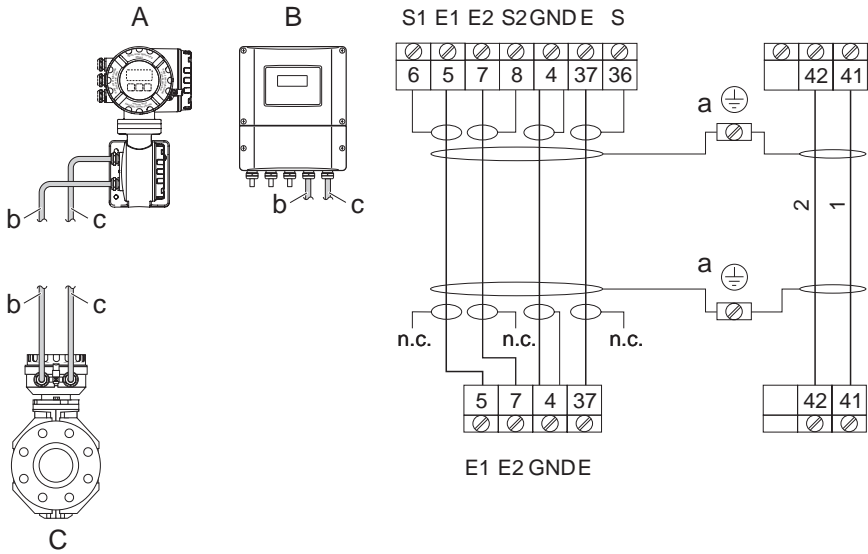

A0008179

- A Transmitter housing on connection housing, remote version  
 B Wall-mount housing on connection housing, remote version  
 C Sensor connection housing, remote version for Promag W/P

- a Ground terminals (are provided for potential equalization connection)  
 b Coil circuit connecting cable  
 c Signal circuit connecting cable (electrodes)

n.c. = not connected, isolated cable shields

Cable colors for terminal numbers:

5/6 = brown

7/8 = white

4 = green

36/37 = yellow

### 3.3 Potential equalization

Perfect measurement is only ensured when the medium and the sensor have the same electrical potential. Most sensors have a reference electrode installed as standard, which guarantees the required potential connection. This usually means that the use of ground disks or other measures are unnecessary.

- Promag W  
Reference electrode available as standard.
- Promag P
  - Reference electrode available as standard for electrode material: 1.4435 (AISI 316L), Alloy C-22 and tantalum
  - Reference electrode optionally available for electrode material: Pt/Rh



Note!

When installing in metal pipes, it is advisable to connect the ground terminal of the transmitter housing to the piping. Pay particular attention to company-internal grounding concepts.

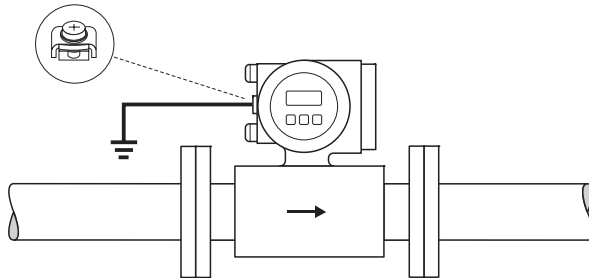

A0004375



Caution!

For sensors without reference electrodes or without metal process connections, carry out potential equalization as per the instructions for special cases described in the Operating Instructions (see the CD). These special measures are particularly important when standard grounding practice cannot be ensured or extremely strong equalizing currents are expected.

### 3.4 Degree of protection

The devices meet all the requirements for IP 67.

After mounting in the field or service work, the following points have to be observed to ensure that IP 67 protection is retained:

- Install the measuring device in such a way that the cable entries do not point upwards.
- Do not remove the seal from the cable entry.
- Remove all unused cable entries and plug them with suitable/certified drain plugs.
- Use cable entries and drain plugs with a long-term operating temperature range in accordance with the temperature specified on the nameplate.

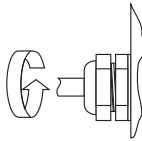

A0007549

Tighten the cable entries correctly.

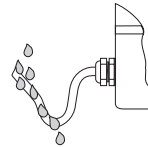

A0007550

The cables must loop down before they enter the cable entries ("water trap").

### 3.5 Post-connection check

- Are cables or the device damaged (visual inspection)?
- Does the supply voltage match the information on the nameplate?
- Do the cables used comply with the necessary specifications?
- Do the mounted cables have adequate strain relief and are they routed securely?
- Is the cable type route completely isolated? Without loops and crossovers?
- Are all screw terminals firmly tightened?
- Have all the measures for grounding and potential equalization been correctly implemented?
- Are all cable entries installed, firmly tightened and correctly sealed?
- Cable routed as a "water trap" in loops?
- Are all the housing covers installed and securely tightened?



## 4 Commissioning

### 4.1 Switching on the measuring device

On completion of the installation (successful post-installation check), wiring (successful post-connection check) and after making the necessary hardware settings, where applicable, the permitted power supply (see nameplate) can be switched on for the measuring device.

When the power supply is switched on, the measuring device performs a number of power-up checks and device self-checks. As this procedure progresses the following messages can appear on the onsite display:

Display examples:

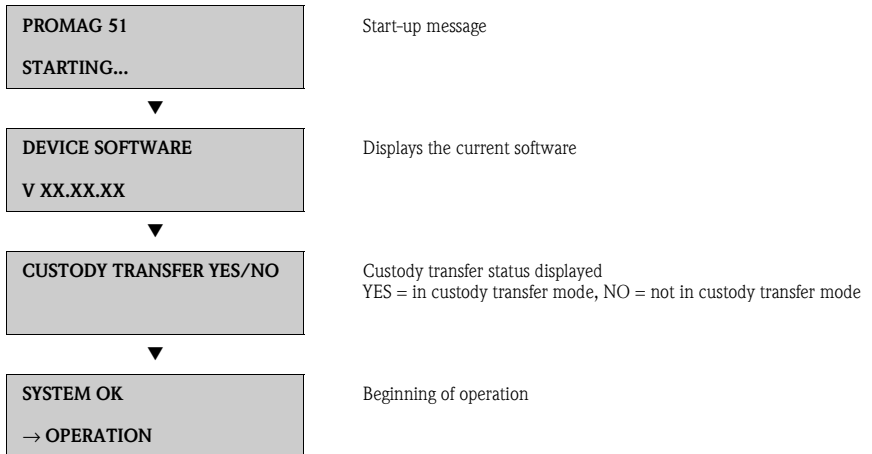

The measuring device starts operating as soon as the startup procedure is complete. Various measured values and/or status variables appear on the display.



Note!

If an error occurs during startup, this is indicated by an error message.

The error messages that occur most frequently when a measuring device is commissioned are described in the Troubleshooting section → Page 30.

## 4.2 Operation

### 4.2.1 Display elements

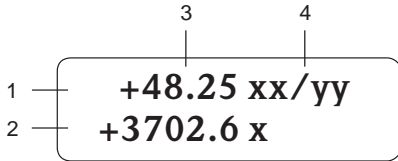

A0007557

Display lines/fields

1. Main line for primary measured values
2. Additional line for additional measured variables/status variables
3. Current measured values
4. Engineering units/time units

### 4.2.2 Operating elements

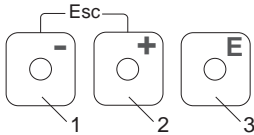

A0007559

Operating keys

1. (-) Minus key for entering, selecting
2. (+) Plus key for entering, selecting
3. Enter key for calling the function matrix, saving

When the +/- keys are pressed simultaneously (Esc):

- Exit the function matrix step-by-step:
- > 3 sec. = cancel data input and return to the measured value display

### 4.2.3 Displaying error messages

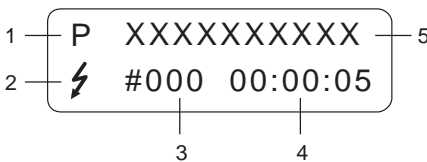

A0007561

1. Type of error:  
P = Process error, S = System error
2. Error message type:  
⚡ = Fault message, ! = Notice message
3. Error number
4. Duration of the last error that occurred:  
Hours: Minutes: Seconds
5. Error designation  
List of all error messages, see associated Operating Instructions on the CD-ROM

### 4.3 Navigating within the function matrix

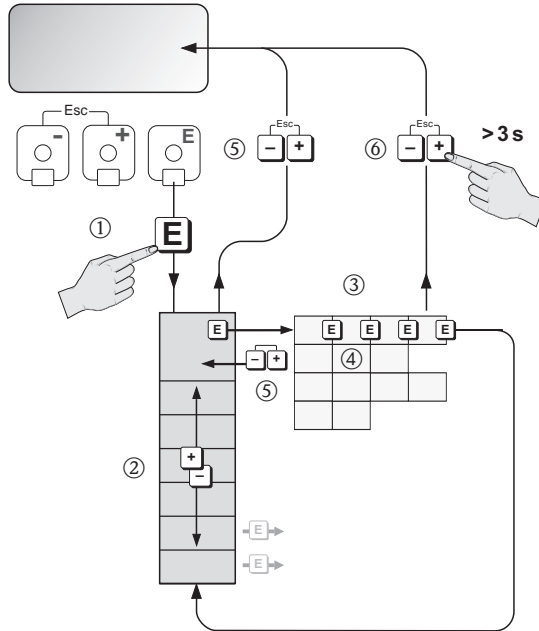













A0007562

1. → Enter the function matrix (starting with measured value display)
2. → Select the group (e.g. OPERATION)  
 → Confirm selection
3. → Select function (e.g. LANGUAGE)
4. → Enter code **51** (only for the first time you access the function matrix)  
 → Confirm entry
5. → Return to measured value display step by step
6. > 3 s → Return immediately to measured value display

## 4.4 Calling the Commissioning Quick Setup

All the functions needed for commissioning are called up automatically with the Quick Setup. The functions can be changed and adapted to the process in question.

1.  → Enter the function matrix (starting with measured value display)
2.  → Select the group QUICK SETUP  
 → Confirm selection
3. QUICK SETUP COMMISSIONING function appears.
4. Intermediate step if configuration is blocked:  
 → Enter the code **51** (confirm with ) and thus enable configuration
5.  → Go to Commissioning Quick Setup
6.  → Select YES  
 → Confirm selection
7.  → Start Commissioning Quick Setup
8. Configure the individual functions/settings:
  - Via -key, select option or enter number
  - Via -key, confirm entry and go to next function
  - Via -key, return to Setup Commissioning function (settings already made are retained)



### Note!

Observe the following when performing the Quick Setup:

- Configuration selection: Select the ACTUAL SETTING option
- Unit selection: This is not offered again for selection after configuring a unit
- Output selection: This is not offered again for selection after configuring an output
- Automatic configuration of the display: select YES
  - Main line = Mass flow
  - Additional line = Totalizer 1
  - Information line = Operating/system conditions
- If asked whether additional Quick Setups should be executed: select NO

All the available functions of the measuring device and their configuration options as well as additional Quick Setups, if available, are described in detail in the "Description of Device Functions" Operating Instructions. The related Operating Instructions can be found on the CD-ROM.

The measuring device is ready for operation on completion of the Quick Setup.

## 4.5 Custody transfer measurement

All the information on using the measuring device for custody transfer measurement is provided in the related Operating Instructions on the CD-ROM. Here, you can also find information on the following subjects:

- Suitability for custody transfer measurement, approval by the Standards Authorities, repeated calibration due to legal metrology controls
- Definition of terms
- Verification process
- Configuring locked operation (custody transfer measurement) (see also description below)
- Lead-sealing the measuring device
- Disabling locked operation (custody transfer measurement)

### 4.5.1 Establishing locked operation (custody transfer measurement)

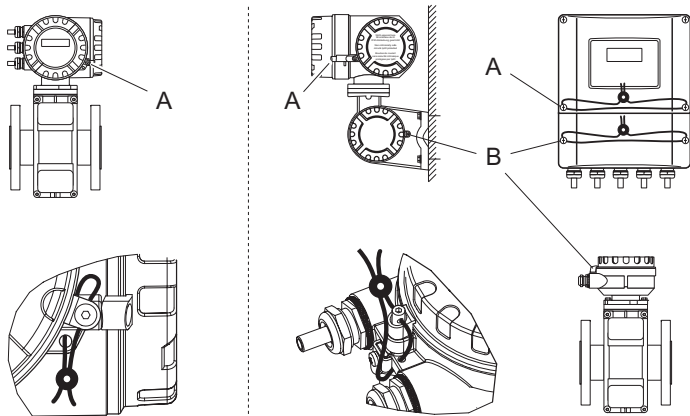

A0005417

Prerequisite: the device is operational and not in the custody transfer state.

1. Open the electronics compartment cover of the transmitter by releasing the appropriate lead-seal screws (A).
2. First of all, configure all the functions that are important for custody transfer measurement, such as "PULSE CT TRANSFER", etc.
3. In the "CODE ENTRY" function, now enter the custody transfer code "5100". The device is now in the custody transfer mode. "CUSTODY TRANSFER YES" appears on the display. This internally specifies and stores the custody transfer mode status in the measuring system.



#### Caution!

- All the functions of the operating matrix which are relevant to custody transfer are automatically locked in custody transfer mode. These functions cannot be modified subsequently on lead-sealed measuring devices; they are marked in the "Description of Device Functions" manual with a keyhole symbol.
  - Additional information on points to note in the custody transfer mode is provided in the related Operating Instructions on the CD-ROM.
4. Securely screw the electronics compartment cover back onto the transmitter housing (in the case of the compact version, also the securing clamp).
  5. The measuring device is lead-sealed as illustrated in the related Operating Instructions on the CD-ROM.
  6. The measuring device now has to be lead-sealed with the lead-seal screws (A, B).

## 4.6 Troubleshooting

A complete description of all the error messages is provided in the Operating Instructions on the CD-ROM.

 **Note!**  
The output signals (e.g. pulse, frequency) of the measuring device must correspond to the higher-order controller.



[www.endress.com/worldwide](http://www.endress.com/worldwide)

---

**Endress+Hauser** 

People for Process Automation

---