



Level



Pressure



Flow



Temperature



Liquid
Analysis



Registration



Systems
Components



Services



Solutions

Operating Instructions

Tank Computer NRM 571

Multi-function receiver for remote gauging system
(Max.40 sensors connectable)



Function and system design

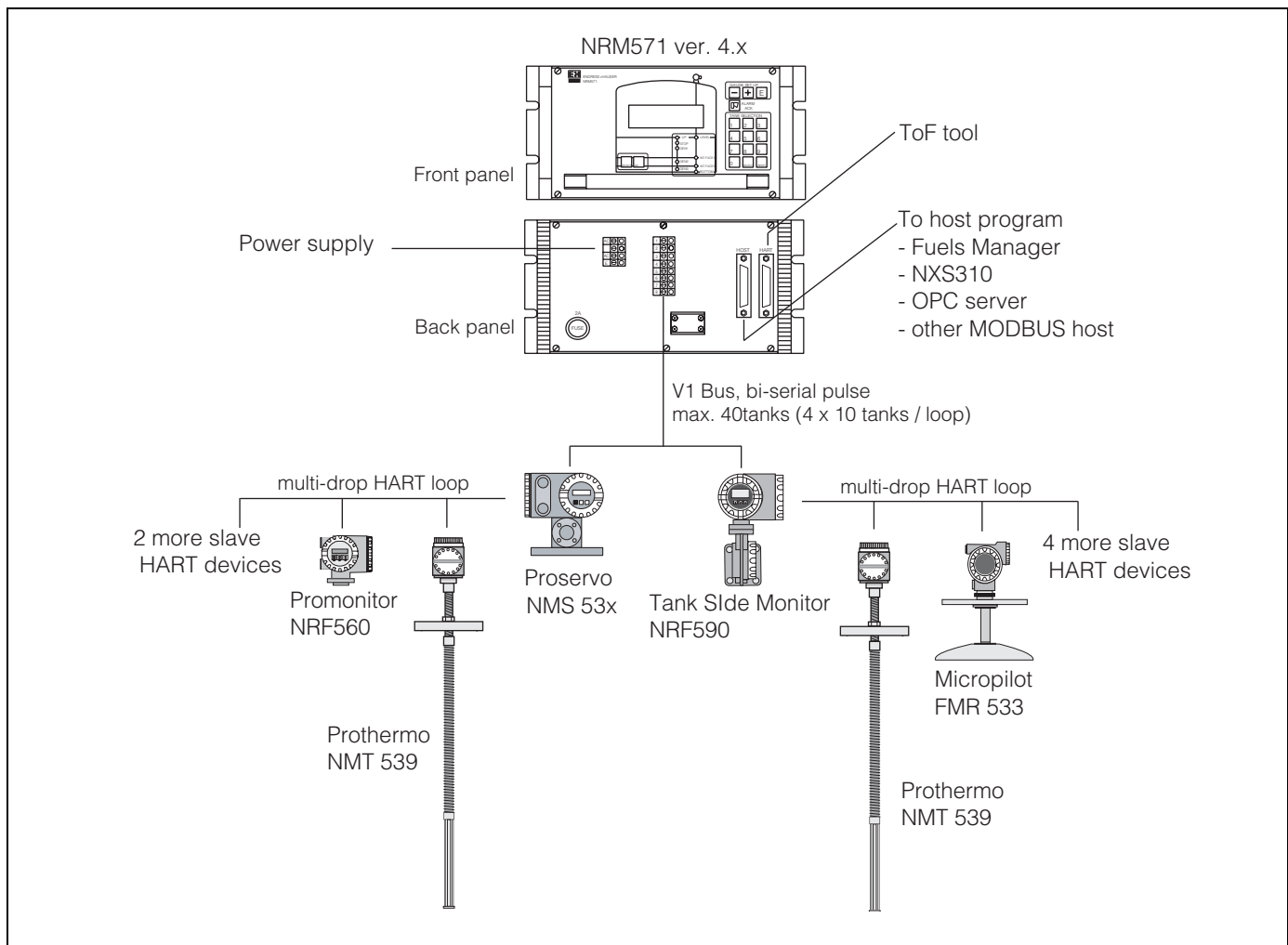

Fig.1 Tank Computer NRM 57x in Endress+Hauser tank gauge device layout

Measuring System

The Tank Computer NRM 571 is a uniquely featured Endress+Hauser tank gauge interface unit designed for relatively small to medium sized tank farms with connectivity to up to 40 tank sensors.

Tank information (level, temperature, density, etc.) are carried on the field bus via the Proservo NMS 53x or Tank Side Monitor NRF 590 to the NRM in the control room. Then, the measured and processed information within the NRM are transmitted to the desired host program

Table of Contents

Safety instructions	4	Initial Adjustment	26
1.1 Designated use	4	6.1 Basic Setting Items and Methods	26
1.2 Installation, commissioning and operation	4	6.2 Communication Setting with Sensor	29
1.3 Note for Handling	4	6.3 Communication Setting with Host	30
1.4 Operational safety	4	Other Functions	31
1.5 Return	5	7.1 FreeScan List & V1 Communication specifications	31
1.6 Disposal	5	Troubleshooting	36
1.7 Software history	5	8.1 When setting the same tank No. to different pages .	36
1.8 Contact addresses of Endress+Hauser	5	8.2 Tank Data Base of NRM	37
1.9 Notes on safety conventions and symbols	6	8.3 Development and Spare parts	38
Identification	7	Appendix A	39
2.1 Nameplate	7	9.1 Matrix Details	39
2.2 Product structure	8	Appendix B	53
2.3 Scope of delivery	8	10.1 Specification for Arithmetic Calculations	53
2.4 Operating Mnuual (BA 005N, this booklet)	8	Appendix C	64
2.5 Certificates and Approvals	8	11.1 Specifications for Host Communication	64
2.6 Registered trademark	8	Appendix D	80
Installation	9	12.1 Alarm Processing	80
3.1 Incoming acceptance, transport, storage	9	Appendix E	84
3.2 Installation Conditions	9	13.1 Value Allowance & Error Retry Setting [372]-[375] .	84
3.3 Electrical connection	10	13.2 Error Types	84
3.4 Device Connections	11	13.3 Tank Number List	86
3.5 Wiring	12		
Operation	13		
4.1 Preparing for Operation	13		
4.2 Operation	13		
Matrix Table	20		

1 Safety instructions

1.1 Designated use

The Tank Computer NRM 571 is a unique intelligent interface unit, combined with data display, calculation and gauge operating functions, to meet the tough demands of today's tank gauging requirements. Unlike a conventional loop connection field interface unit, the Tank Computer NRM 571 is able to display the measured values of level, interface level, density, pressure and water dip along with gauge status and alarm signals on the integrated LCD display.

The NRM 571 can be connected to up to 40 sensors via V1 bi-serial communication in order to collect measured values. These data can be directly transmitted and /or calculated by an integrated conversion table within the Tank Computer to the host tank gauge program via RS 232C output. With integrated front panel key pads, an operator can directly command gauges without an auxiliary remote controller.

1.2 Installation, commissioning and operation

- Mounting, electrical installation, start-up and maintenance of the instrument may only be carried out by trained personnel authorized by the operator of the facility.
- Personnel must absolutely and without fail read and understand this Operating Manual before carrying out its instructions.
- The instrument may only be operated by personnel who are authorized and trained by the operator of the facility. All instructions in this manual are to be observed without fail.
- The installer must make sure that the measuring system is correctly wired according to the wiring diagrams. The measuring system is to be grounded. Detailed Installation instructions are described in BA025N/08/en.
- Please observe all provisions valid for your country and pertaining to the opening and repairing of electrical devices.

1.3 Note for Handling

Power cable

- Use cables recommended by Endress+Hauser co., ltd.
- Be sure to ground the cables. For details, refer to "Device Connections" and "Installation"

Grounding

- Do not remove a ground terminal or wire power is on.
- For details, refer to "Device Connections"

Handling of NRM

- The Tank Computer NRM may be connected the peripheral devices described in this manual. For use of these devices, please refer to thire respective operating manuals. To avoid accidents and injury, operate this device according to guidelines provided.

1.4 Operational safety

Hazardous area

Measuring systems for use in hazardous environments are accompanied by separate "Ex documentation", which is an integral part of this Operating Manual. Strict compliance with the installation instructions and ratings as stated in this supplementary documentation is mandatory.

- Ensure that all personnel are suitably qualified.
- Observe the specifications in the certificate as well as national and local regulations.

FCC approval

This device complies with part 15 of the FCC Rules. Operation is subject to the following two conditions: (1) This device may not cause harmful interference, and (2) this device must accept any interference received, including interference that may cause undesired operation.

Power source

If the device uses a separate power supply, verify that the power supply voltage matches that of the device before turning on power.

External connection

If external connections are required, before connecting the device to an external control circuit, provide protective grounding

Caution!



Changes or modifications not expressly approved by the party responsible for compliance could void the user's authority to operate the equipment.

1.5 Return

The following procedures must be carried out before the NRM 57x is sent to Endress+Hauser for repair:

- Always enclose a duly completed "Declaration of Contamination" form. Only then can Endress +Hauser transport, examine and repair a returned device.
- Enclose special handling instructions if necessary, for example, safety data sheet as per EN 91/155/EEC.
- Remove all residue which may be present. Pay special attention to the gasket grooves and crevices where fluid may be present. This is especially important if the fluid is dangerous to health, e.g. corrosive, poisonous, carcinogenic, radioactive, etc.

A copy of the "**Declaration of Contamination**" is included at the end of this operating manual.

Caution!



- No instrument should be sent back for repair without all dangerous material being completely removed first, e.g. in scratches or diffused through plastic.
- Incomplete cleaning of the instrument may result in waste disposal or cause harm to personnel (burns, etc.). Any costs arising from this will be charged to the operator of the instrument.

1.6 Disposal

In case of disposal, please separate the different components according to their material consistency.

1.7 Software history











Software version / Date	Software changes	Documentation changes
	Original software. -	

1.8 Contact addresses of Endress+Hauser

The addresses of Endress+Hauser are given on the back cover of this operating manual. If you have any questions, please do not hesitate to contact your E+H representative.

1.9 Notes on safety conventions and symbols

In order to highlight safety-relevant or alternative operating procedures in the manual, the following conventions have been used, each indicated by a corresponding symbol in the margin.

Safety conventions	
	Warning! A warning highlights actions or procedures which, if not performed correctly, will lead to personal injury, a safety hazard or destruction of the instrument
	Caution! Caution highlights actions or procedures which, if not performed correctly, may lead to personal injury or incorrect functioning of the instrument
	Note! A note highlights actions or procedures which, if not performed correctly, may indirectly affect operation or may lead to an instrument response which is not planned
Explosion protection	
	Device certified for use in explosion hazardous area If the device has this symbol embossed on its name plate, it can be installed in an explosion hazardous area
	Explosion hazardous areas Symbol used in drawings to indicate explosion hazardous areas. – Devices located in and wiring entering areas with the designation “explosion hazardous areas” must conform with the stated type of protection
	Safe area (non-explosion hazardous area) Symbol used in drawings to indicate, if necessary, non-explosion hazardous areas. – Devices located in safe areas still require a certificate if their outputs run into explosion hazardous areas
Explosion protection	
	Direct voltage A terminal to which or from which a direct current or voltage may be applied or supplied
	Alternating voltage A terminal to which or from which an alternating (sine-wave) current or voltage may be applied or supplied
	Grounded terminal A grounded terminal, which as far as the operator is concerned, is already grounded by means of an earth grounding system
	Protective grounding (earth) terminal A terminal which must be connected to earth ground prior to making any other connection to the equipment
	Equipotential connection (earth bonding) A connection made to the plant grounding system which may be of type e.g. neutral star or equipotential line according to national or company practice

2 Identification

2.1 Nameplate

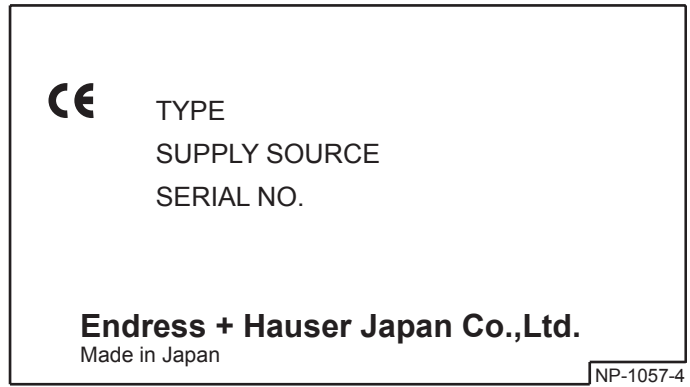

2.2 Product structure

10	Model type			
	1	Panel mounted type		
	2	Desktop type		
	9	Special version		
20	Power supply			
	1	AC85 ~ 264 V		
	9	Special version		
30	Input			
	A	Rackbus RS-485 (software ver. 2.x)		
	B	V1 bi-directional 2 wire transmission (software ver. 2.x)		
	C	Rackbus RS-485 + V1 bi-directional 2 wire transmission (software ver. 2.x)		
	D	V1 bi-directional digital transmission (software ver. 4.x)		
	Y	Special version		
40	Output			
	A	RS232C		
	Y	Special version		
50	Tank table			
	1	Standard		
	2	280 points (software ver. 2.x only)		
	3	200 points (20 tanks only)		
	9	Special version		
60	Tank data configuration			
	0	Not required (customer configuration)		
	1	Required (factory configuration)		
NRM571-				Complete product designation

2.3 Scope of delivery

- Instrument according to the version ordered
- ToF Tool (operating program)
- Operating manual (this manual)

2.4 Operating Manual (BA 005N, this booklet)

Describe the installation and commissioning of the Tank Computer NRM 57x .

2.5 Certificates and Approvals

CE mark, declaration of conformity

The instruments is designed to meet state-of-the-art safety requirements, has been tested and left the factory in a condition in which it is safe to operate. The instrument complies with the applicable standards and regulations and thus complies with the statutory requirements of the EG directives.

Endress+Hauser confirms the successful testing of the instrument by affixing to it the CE mark.

2.6 Registered trademark

HART®

Registered trademark of HART Communication Foundation, Austion, USA

ToF®

Registered trademark of the company Endress+Hauser GmbH+Co.KG, Maulburg, Germany

3 Installation

3.1 Incoming acceptance, transport, storage

3.1.1 Incoming acceptance

Check the packing and contents for any signs of damage.

Check the shipment, make sure nothing is missing and that the scope of supply matches your order.

3.1.2 Transport

Caution!

Follow the safety instructions and transport conditions for instruments of more than 4.5kg

3.1.3 Storage

Pack the measuring instrument so that it is protected against impacts for storage and transport. The original packing material provides the optimum protection for this.

The permissible storage temperature is

- -10 to +60 °C

3.2 Installation Conditions

3.2.1 Dimensions, Weight

The Tank Computer NRM can be used as a rack mount type or desktop type depending on installation conditions.

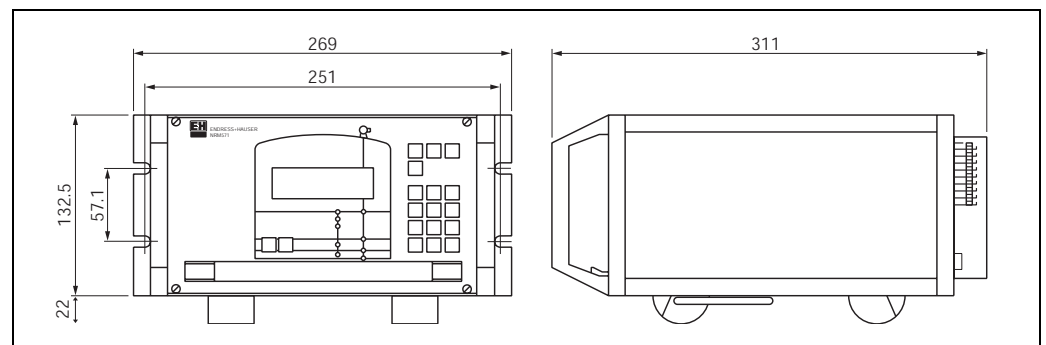

Fig 2. NRM dimension

Weight

About 4.5 kg

3.2.2 Panel Cut

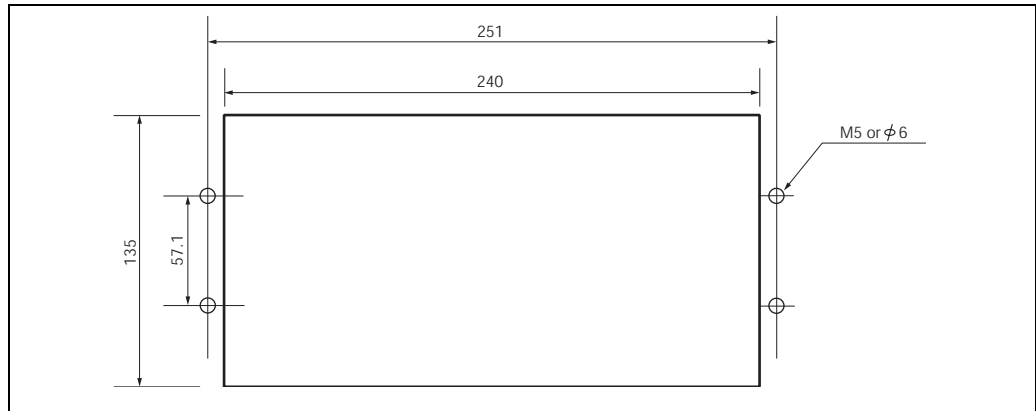

Fig 3. NRM rack mount panel cut dimension

Note!

Thickness of rack mount installation panel shall be more than 2mm.

3.2.3 Installation environment

- Temperature : 0 to +50°C
- Humidity (no condensation) : 20 to 80 %

3.2.4 Electricity

- Input voltage : AC85 to 264V
- Input frequency : 50 / 60 Hz
- Power consumption : 13 VA
- Ground resistance : 10 ohm or less

3.3 Electrical connection

The NRM has the simplest terminal connection to field sensors and host connection on its back panel.

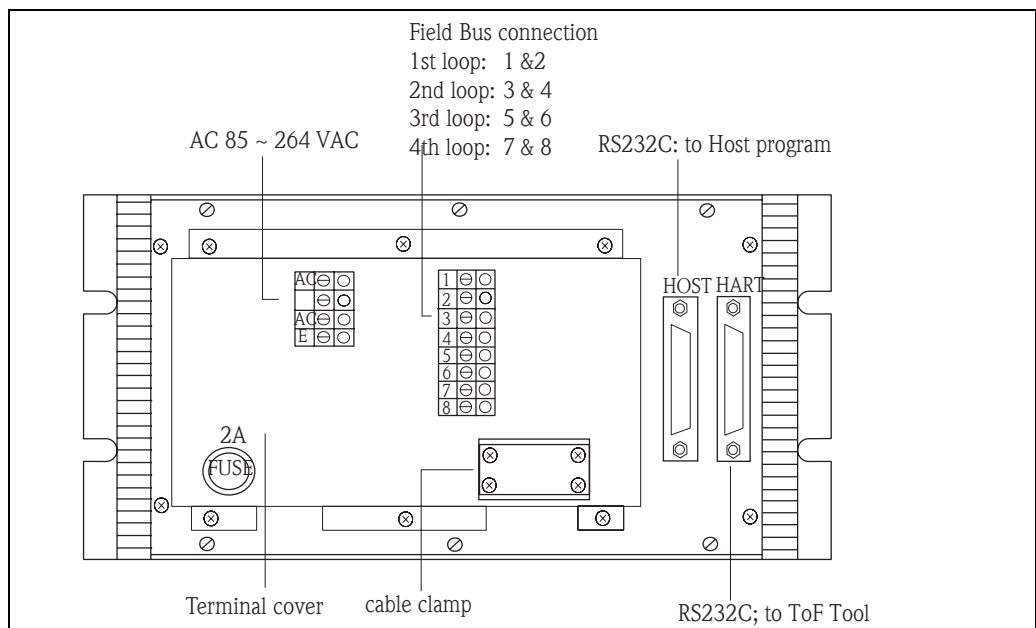

Fig 4. NRM terminal connection

- Huse: 2A
- Terminal cover: Be sure to install this cover after wiring.
- Cable clamp: Fix a cable at its shield portion.
- Terminal: Used for an input power supply.
- Connector for host: RS 232C connector for host (D-SUB 25S)
- Connector for HART maintenance: For maintenance (D-SUB 25S)

3.4 Device Connections

Prepare a separate power supply (AC) for sensors.



Warning!
Be sure to disconnect power to NRM before connecting the devices.

3.4.1 Sensor Communication

There are 2 types of sensor communication.
Refer to the section according to your sensor communication type from this diagram.

Sensor type	Sensor communication	Refer to
NMS, TGM, TMD, TSN, MX/MS	V1 serial bus (V1, MDP)	3.4.2 V1 serial bus communication

3.4.2 V1 Serial bus

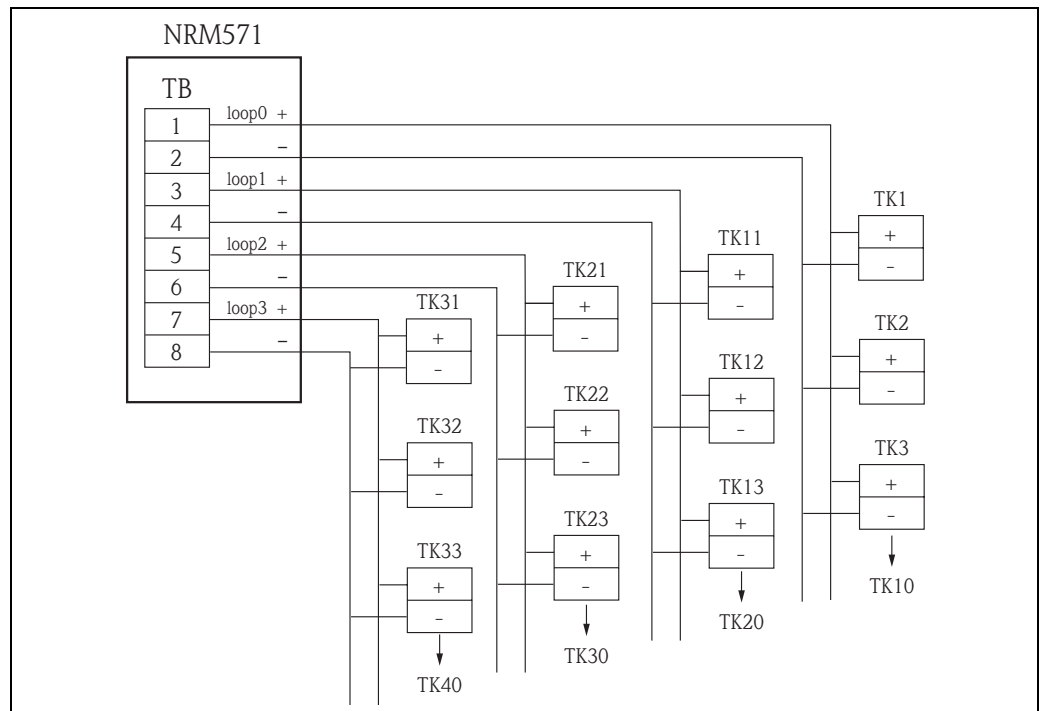

Fig 5. V1 Communication

This connection diagram shows a configuration in which 40 sensors (NMS/ TGM/ TMD(MX/MS)) are connected. As for sensor connection, refer to sensors' operating manual for where cable should be connected. There are 4 loops (1-2, 3-4, 5-6, 7-8). Each loop can connect 10 sensor maximum. Different types of signals cannot be mixed but different types of sensors in one loop.



Note!
If the sensor communication is DX, maximum of 1 sensor can be connected per loop.

3.4.3 Host Communication

3.4.3.1 RS232C Communication

The RS232C output (host communication) uses the connector (D-SUB25S)

3.4.4 Power Supply

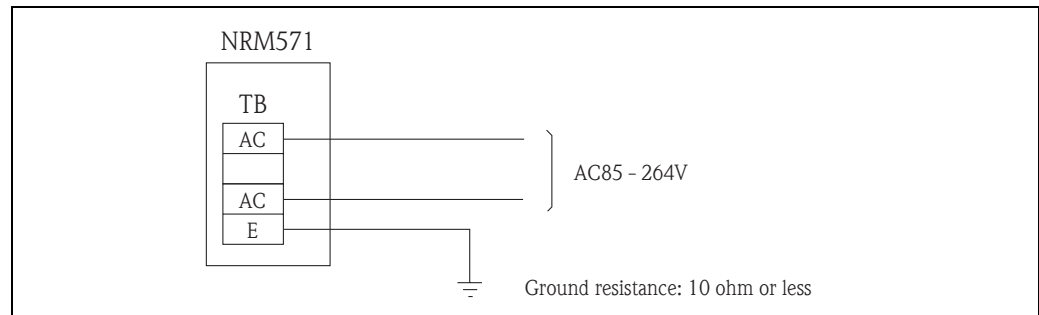

Fig 6. Power Supply

3.5 Wiring

communcation	Cable material	Recomended
V1 serial bus (sensor to NRM)	Twisted cable	IEC 60708
Power cable (sheath)	PVC (Polyvinyl) or PE (Polyvinyl chloride)	Use wires capable of withstanding 600V

Wiring to NRM must start from the terminal block on its rear surface.

3.5.1 Shield cable Covering

Remove an extra 20 mm of the coating from the shield portion of the shield cable so that it can be fixed to the rear panel using a cable clamp.

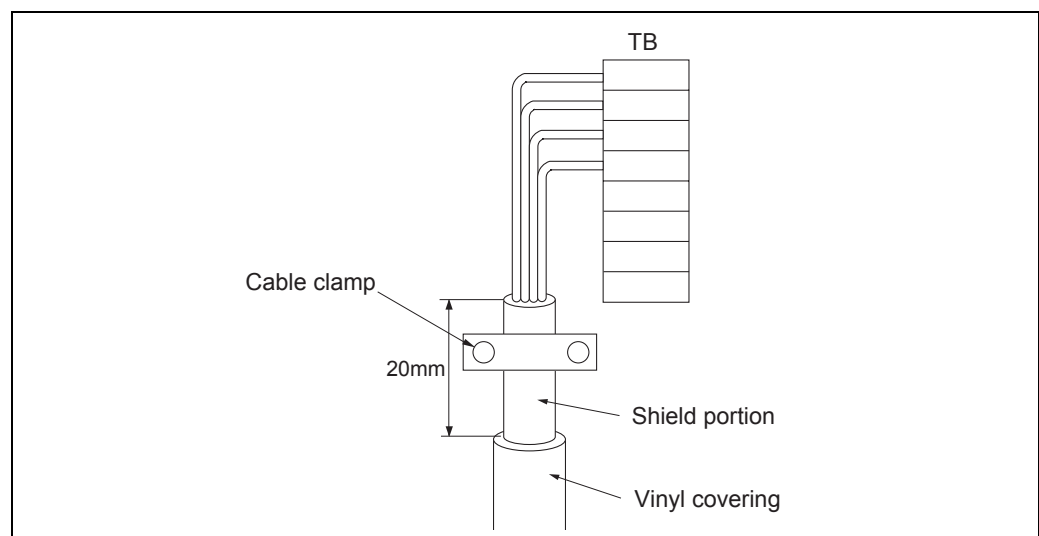

Fig 6. Shield cable covering

After the wirings are completed, install the attached terminal block cover.

4 Operation

4.1 Preparing for Operation

4.1.1 Check before power-on



Caution!
Before power-on please note the followinga:

- The input power voltage must be within the rated voltage range.
- The cable must be correctly connected to the terminal block.
- The fuse on the rear surface of the Tank Computer NRM 571 has the rated current (2A).

4.1.2 Power-on

Turn on the power to switch or breaker which is provided by user.

4.1.3 Power-off

Turn off the power switch provided by the user.
To disconnect, turn off the power for the proservo NMS 53x and the Tank Gauging TGM 4000.

4.1.4 Initial Set Values

In the Tank Computer NRM 571, basic data required for operation is registered in the internal matrices. Since default values are written to the attached matrices before shipment, these settings should be changed according to the user's needs.

For basic steps in setting these values, please refer to " Initial Adjustment".

4.2 Operation

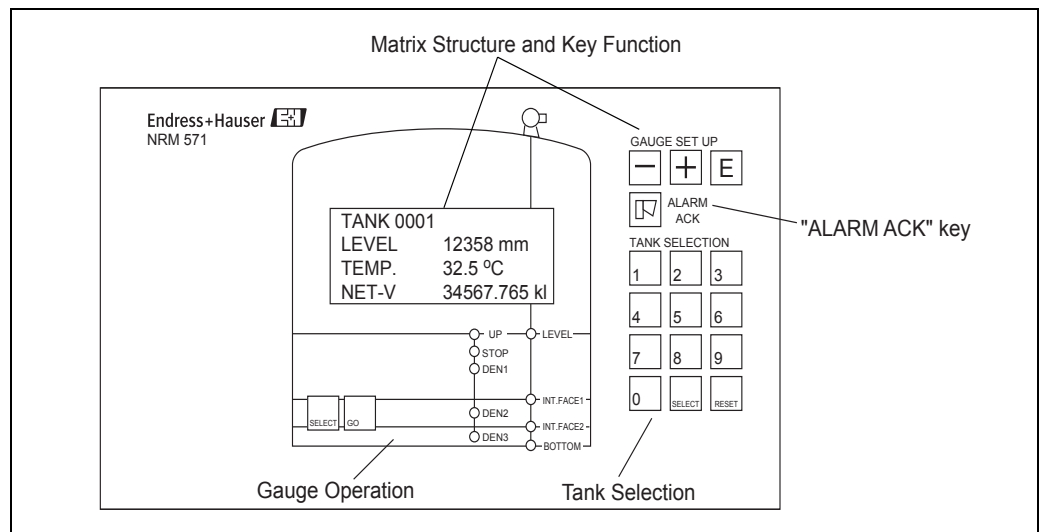

Fig 7. NRM Front Panel2

4.2.1 Matrix Structure and Key Function

4.2.1.1 Display

The Tank Computer NRM 571 has an illuminated LCD that consists of four lines with 20 characters each. During normal operation, it shows the level and the temperature of selected tank on the "HOME" position. The display of HOME position will be explained in "4.2.1.3 HOME position".

For the display of the other data and the setting of the parameters for operation, the Tank Computer NRM 571 uses a programming matrix.

4.2.1.2 Main Display

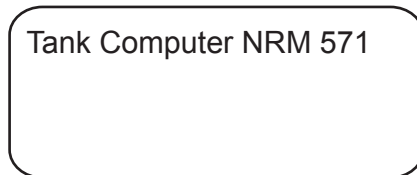

When power is turned on, Main Display appears. You can enter HOME Position by selecting tank number and press [SELECT] key and go back to Main Display from HOME Position by using [RESET] key.

Note!



Please make sure to go back to Main Display after finishing the data display and setting.

4.2.1.3 HOME Position

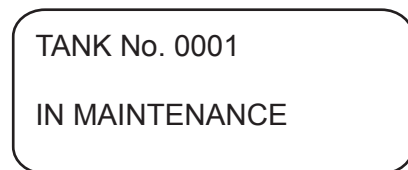

HOME Position has two modes. One is maintenance mode, the other one is normal operation mode. NRM 571 is shipped in maintenance mode.

The mode can be switched at [150] TANK CONDITION.

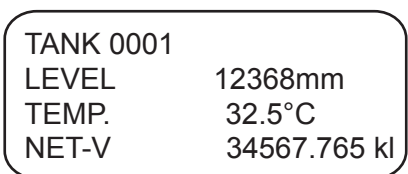

Data items to be displayed (in the normal operation mode) can be changed by providing settings in the Programming Matrices. (Refer to "fig. ")

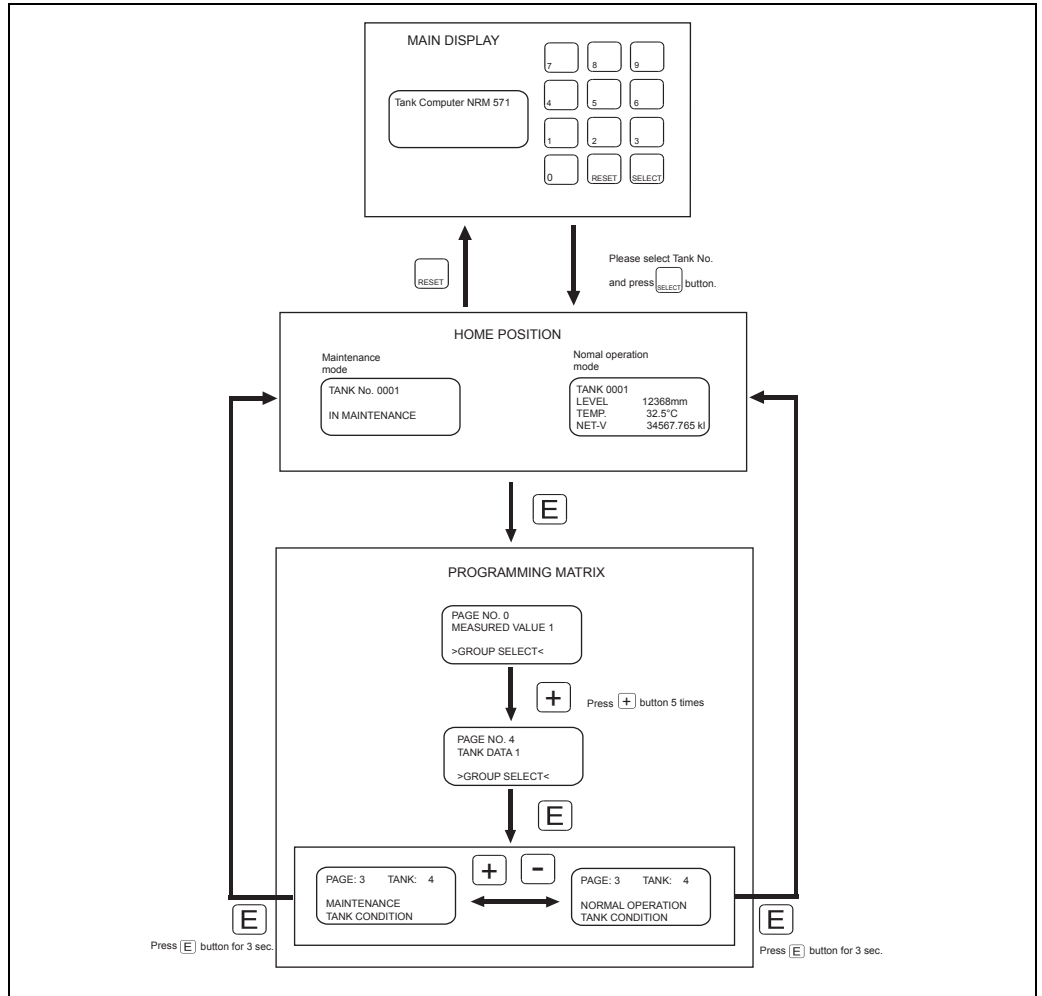

Fig 8. Main display, HOME position & Programming Matrix

4.2.1.4 Programming Matrices

The programming matrix consists of 6 matrix groups, one "STATIC" matrix group (G0) and 5 "dynamic" matrices (G1-G5). Fig 8. below shows how the programming matrix is structured.

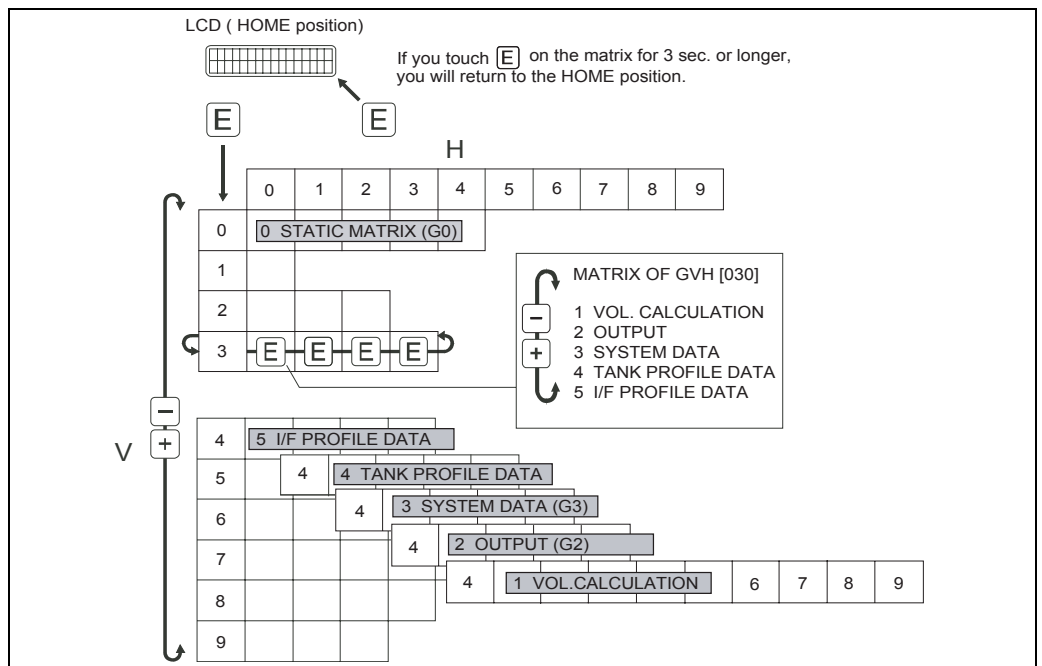

Fig. 9 Matrix structure

STATIC MATRIX (G0), GVH[000]-[039]

Row 0...3 of the programming matrix are called the static matrix.

Major Function: stores measured data (level, temperature, volume, etc.)

Access: available at any time

DYNAMIC MATRICES (G1-G5)

Row 4...9 of the programming matrix exist on 3 different dynamic matrices. These matrix groups are labelled as follows. Access is available only when it is selected at "[030] MATRIX OF".

- VOL. CALCULATION (G1) GVH [140] - [199]
Function : stores registered data such as tank tables related to arithmetic operation.
- OUTPUT (G2) GVH [240] - [299]
Function : stores registered data for alarms.
- SYSTEM [G3] GVH [340] - [399]
Function : stores registered data related to NRM system data.
- TANK PROFILE [G4] GVH [440] - [495]
Function : stores registered data related to Tank Profile data.
- I/F PROFILE [G5] GVH [550] - [595]
Function : stores registered data related to I/F Profile data.

4.2.1.5 Matrix Location Code

Throughout this manual, locations in the matrix are referred to in the format.

[GVH] (Group, Vertical, Horizontal)

For Example: [220]

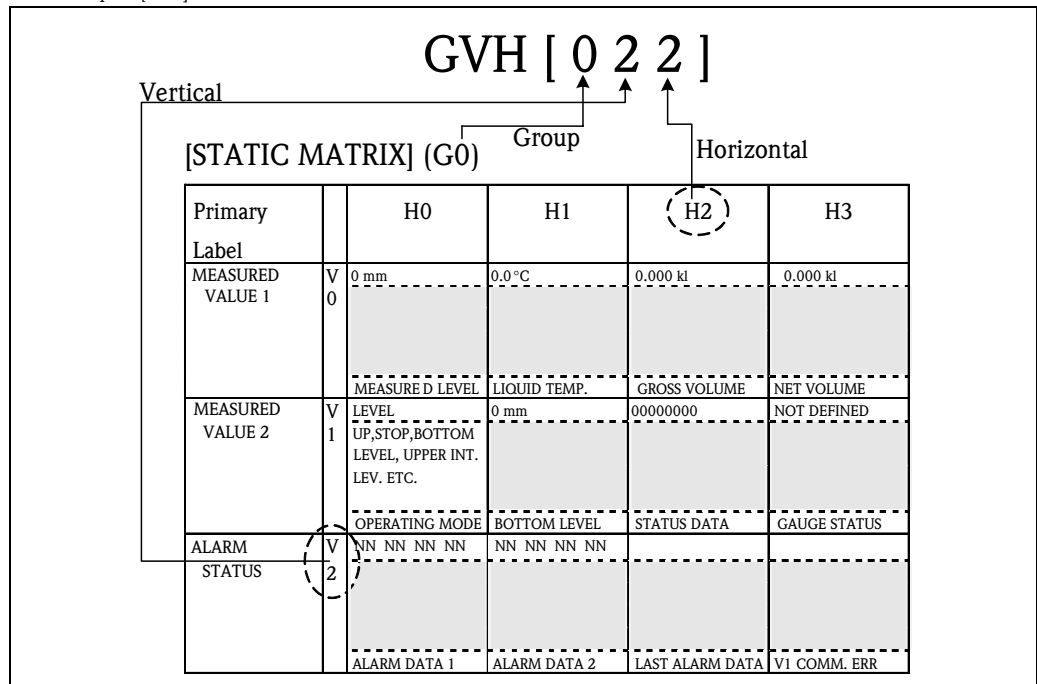





Fig. 10 STATIC MATRIX Structure

The matrix location [220] for example, refers to the Static Matrix(G0), Alarm Status (V2), Alarm Data (H2). The Primary Label Column in the matrix does not have a Horizontal reference. Therefore, MEASURED VALUE 1 is referred to as matrix location [00_].

4.2.1.6 Functions of the "GAUGE SET UP" keys

The individual matrix groups, function groups, and functions within the programming matrix can be selected by three GAUGE SET UP key [E], [-] and [+].

Key	Functions
	<ul style="list-style-type: none"> • Access to the programming matrix • Return to the HOME position (pressing the key for 3 sec. or more) • Moving horizontally within a function group to select functions • Saving parameters or access code
 	<ul style="list-style-type: none"> • Moving vertically to select function groups • Selecting or setting parameter • setting access code

4.2.1.7 Functions of the "GAUGE SET UP" keys

The access cod is to ensure the confidentiality of the data setup or data change.

Proper access code input : "EDITING ENABLE"

Improper access code input : "EDITING LOCKED"
will be shown on the screen.



Note!

Once setting, the access code is retained. Thus, when setting is finished, set the access code bock to "0".

Access code level : Refer to "Appendix A Matrix Details" - column "Access code"

Access code setting : Refer to "6. 1 Access Code Setting"

4.2.2 Tank Selection

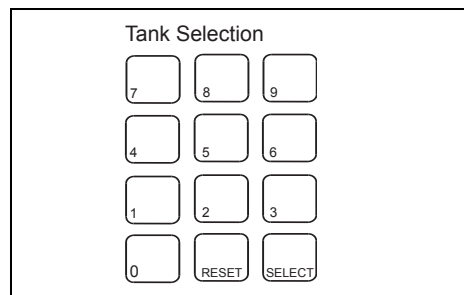

The keys used to select a tank include the ten keys [0] to [9] and the [SELECT] and [RESET] keys. To select a tank number, enter the number registered in the NRM matrix and press the [SELECT] key. To delete the data, press the [RESET] key.

Fig. 11 Tank Selection

4.2.3 Gauge Operation

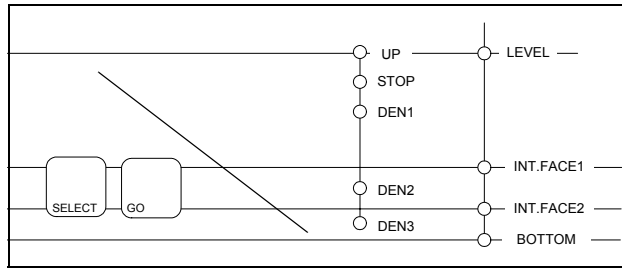

The 2 keys enable gauge operation for the selected NMS/TGM level gauge. Gauge operation is available only when the corresponding single tank is selected.

Fig. 12 Gauge Operation

4.2.3.1 Operation

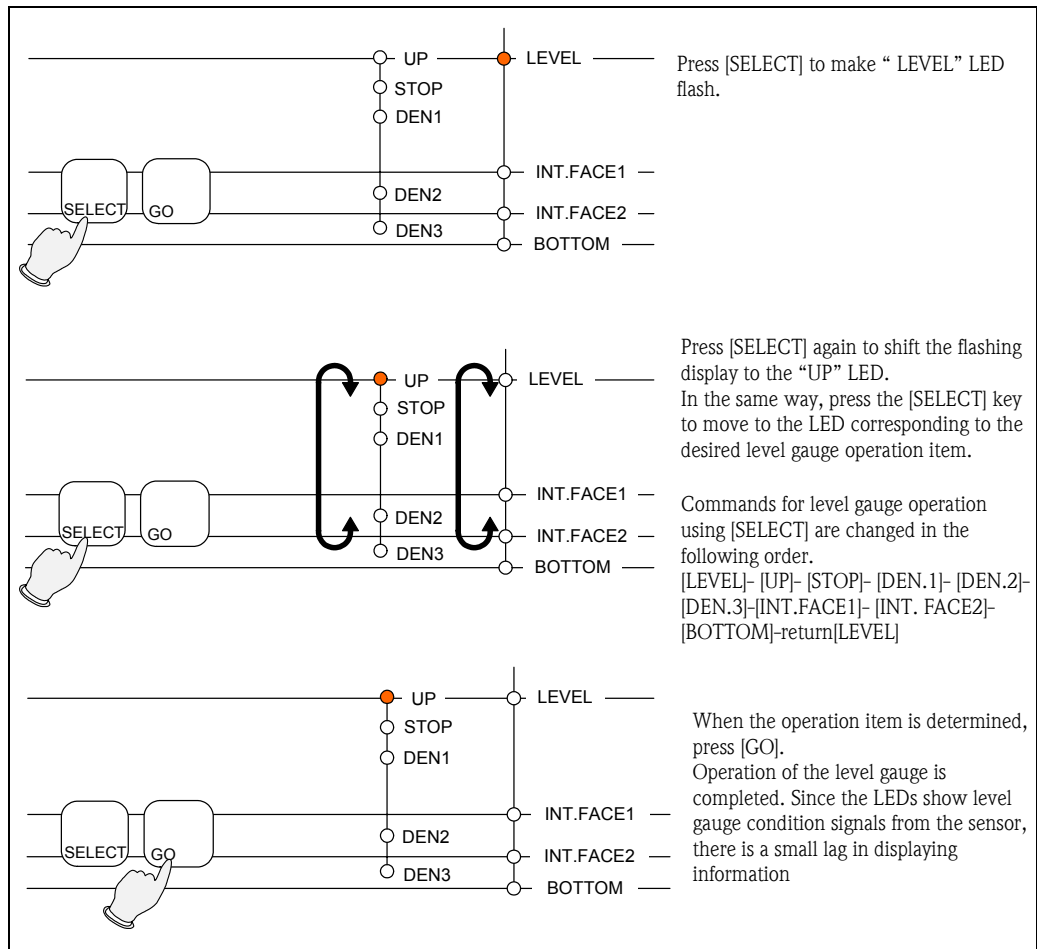

Fig. 13 Operation



Note!

Gauge can also be operated by selecting operation type in [010] OPERATING MODE.

4.2.3.2 Difference in Operation

Operation items differ depending on sensor type and communication method.

Sensor & Protocol	Sensor type			
	NMS 53x		TGM	
	V1	MDP	V1	MDP
Operation				
LEVEL	OK	OK	OK	OK
UP	OK	OK	OK	OK
STOP	OK	OK	OK	OK
DEN.1	OK		*	
DEN.2	OK			
DEN.3	OK			
INT.FACE1	OK		*	
INT.FACE2	OK			
BOTTOM	OK			

- OK : Enabled
- * : Depends on SW version
- V1 : V1 serial bus communication
- MDP : Old bi-directional 2 wire communication

Note!
TMD/MX/MS transmitters : All operations not available

4.2.3.3 "ALARM ACK" key



If a level, temperature, or volume alarm occurs, the buzzer inside NRM is activated. Press "ALARM ACK" key to turn off the buzzer. If multiple alarms are simultaneously set off, you can use this key to delete the alarm display while confirming alarms one by one. In addition, you can use this key to reconfirm alarm data for the tank, which is now in alarm condition.

Fig. 14 "ALARM ACK" key

5 Matrix Table

NRM 571 MATRIX

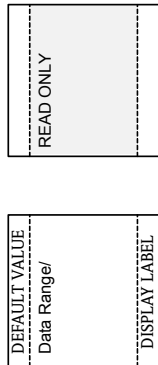

[STATIC MATRIX] (G0)

Primary Label	H0	H1	H2	H3	H4	H5	H6	H7	H8	H9
MEASURED VALUE 1	V 0 mm	0.0°C	0.000 kl	0.000 kl	0.000 t	0.0000 g/cm3	1.0000 g/cm3	0 mm	0.0 °C	1.000 kg/cm2
MEASURED VALUE 2	MEASURED LEVEL	LIQUID TEMP.	GROSS VOLUME	NET VOLUME	MASS	DENSITY	REF. DENSITY	WATER LEVEL	GAS TEMP.	GAS PRESSURE
	V LEVEL	0 mm	00000000	NOT DEFINED	BALANCED		0 mm	0.0000 g/cm3	0.0000 g/cm3	
	UP,STOP,BOTTOM LEVEL, UPPER INT. LEV. ETC.									
ALARM STATUS	OPERATING MODE	BOTTOM LEVEL	STATUS DATA	GAUGE STATUS	BALANC.STATUS		MIDD.INTERF.LEV.	MIDDLE DENSITY	DENSITY BOTTOM	4.XX
	V NN NN NN NN	NN NN NN NN								
MATRIX OF	ALARM DATA 1	ALARM DATA 2	LAST ALARM DATA	V1 COMM. ERR	LAST COMM. ERR	SENSOR ALARM	SENSOR ERROR			SOFTWARE VER.
	V VOL.CALCULATION		0			OFF				00
	OUTPUT		0-39			ON				00-99
	SYSTEM DATA									
	TANK PROFILE									
	I/F PROFILE									
	MATRIX OF		SELECT PAGE			HART MODE				ACCESS CODE

[VOL.CALCULATION] (G1)

Primary Label	H0	H1	H2	H3	H4	H5	H6	H7	H8	H9
MANUAL DATA	V - 1: Measured data 0 - 99999 mm	H1 -100: Measured data -99.9 - +300.0 °C	H2 1.0000 g/cm3 0.0001-9.9999 g/cm3 - 1000: Measured data	H3 0 mm 0 - 99999 mm - 1: Measured data	H4 0.0°C -99.9 - +300.0 - 100: Measured data	H5 1.000 kg/cm2 999.999- +99.999 kg/cm2 -1000: Measured data	H6 1.0000 g/cm3 0.0001-9.9999 g/cm3	H7 0.000 % 0 - 99.999 %	H8	H9
TANK DATA 1	MANUAL LEVEL MAINTENANCE NORMAL OPERATI	MANUAL LIQ.TEMP. NMS1 NMS2 NMS3 TGM TMD	MANUAL DENSITY V1 MDP V1 TSM_V1 TGM_V1	MANU.WATER LEV 0001- 0039 0000- 9999	MANU.GASTEMP. 000- 001 XTY X: LOOP No. YY: ADDRESS 00-09	MANU. GAS PRESS. 0 0 - 99	MANU.GAS DENS. 999999.999 kl 0.000 - +999999.999 kl	WATER CONTENT 0 mm 0 - 99999 mm	0.000 kl -999.999- 999.999 kl	1.0000 g/cm3 0.0001- 9.9999 g/cm3
TANK DATA 2	TANK CONDITION 0.000000 t 999.999999 t	SENSOR TYPE 0 mm 0 - 99999 mm	SIGNAL INPUT 0.0 °C -99.9 - +300 °C	TANK NUMBER 0.00000000 0 - ±9.999999999	POLLING ADDRESS 0.00000000 0 - ±9.999999999	PULSE WIDTH 0.0°C 99.9 - +300 °C	TANK CAPACITY 0.000 0.000- 99.999	TANKLEV.CORREC POINTER No.0 POINTER 0- 29	VOL. CORRECTIO 0 mm 0 - 99999 mm	DENSITY CARIBR. 0.000 kl 0.000 - +999.999 kl
STRAPPING TABLE	FLOATROORWEIGH POINTER No.0 POINTER: 0- 63	FLOAT ROOF LEV. 0 mm 0 - 99999 mm	VCF REF.TEMP. 0.000 kl 0.000- 999999.999 kl	VCF FOR CHEMICAL 00000.10^- 8 kl 0 - 99999.10^- 8 kl	TANKEXPAN.COEF 0.000 kl 0.000 - 99.999 kl	EXPAN.REF.TEMP. 00000.10^- 8 kl 0 - 99999.10^- 8 kl	MOL WEIGHT	WATERLEV. TABL	STRAPWATERLEV. STRAPWATER	
ST TANK TABLE	TANK TABLE 0.0000 -0.9999- 9.9999	STRAPPING LEVEL 0 .10^- 9 0 - ±99999	STR.VOL.UP.DGT 0.000 -999.999 - +999.999	STR.VOL.LO.DGT 0 .10^- 8 0 - ±99999	NET AREA UP.DGT 0 -9999 - +9999	NET AREA LO.DGT 0 .10^- 6 0 - ±999999	0 -99999 - +99999	0 .10^- 5 0 - ±99999		
CALCULATION	ST CONSTANT P1 CRT FRT ST	ST CONSTANT P2 NONE METHOD -1 METHOD -2	ST CONSTANT Qn1 NONE GROSS VOL. NET VOL.	ST CONSTANT Qn2 NONE GROSS VOL. NET VOL.	ST CONSTANT Rn1 NONE ASTM(T54A,T54B, 54,55,6X,T2, XYLENE,etc.)	ST CONSTANT Rn2 METHOD-1 METHOD-2 METHOD-3 METHOD-4	ST CONSTANT Sn1 NONE METHOD-1 METHOD-2 METHOD-3 METHOD-4	ST CONSTANT Sn2 API JAPANESE 53A 53B 53D 53		
	TANK TYPE	GROSSVOL.CALCU	SUBTR.WATERLEV.	SUBTR.WATERCO	NET VOL.CALC.TAB	NETVOL.CALCULAT	MASSCALCULATIO	VOLUME DATA		

[OUTPUT] (G2)

Primary Label	H0	H1	H2	H3	H4	H5	H6	H7	H8	H9
ALARM ASSIGNMENT	V 4 POINTER No.0 POINTER: 0 - 7	NONE LEVEL,TEMP. GROSS VOL.,NET VOL.,MASS	SKIP IN DEFAULT DEPEND ON EACH UNIT	SKIP IN DEFAULT LOW ALARM HIGH ALARM						
	V 5	ALARM SELECTION	ALARM ASSIGNMENT	ALARM ASSIGNMENT						
	V 6									
	V 7									
	V 8									
	V 9									

[SYSTEM DATA] (G3)

Primary Label	H0	H1	H2	H3	H4	H5	H6	H7	H8	H9	
CLOCK	V 00/01/01 00:00 4 YV/MM/DD	00 00-99	01 01-12	01 01-31	00 00-23	00 00-59	00 00-59			NO RESET RESET CURR.TANK RESET ALL TANKS CURR.TANK	
COMMUNICATION	V NONE 5 MDP BBB MODBUS (5 map) COMMUNICATION	YEAR SETTING 19200 BPS 2400 BPS 4800 BPS 9600 BPS	MONTH SETTING 7 BITS 8 BITS	DATE SETTING NONE EVEN ODD	HOURLY SETTING ONE STOP BIT TWO STOP BITS	MINUTE SETTING 0 mm 0-999 mm	SECOND SETTING 0.0 °C 0.0-99.9 °C	0.000 kl 0.000 - 99.999 kl	0.000 t 0.000 - 99.999 t	1 1-247	DEFAULT VALUES
DEVICE NAME	V ENGLISH 6 JAPANESE	BAUD RATE 0-21	DATA LENGTH 1 0-999	PARITY	STOP BIT 4.XX	LEV.ALARM HYST. 1 0-15	TEMP.ALARM HYST.	VOL.ALARM HYST.	MASS ALARM HYST.	MODBUS ADDRESS OFF ON	
ERROR INFO.	V LANGUAGE NO ERROR 7 V1/IF CPU ERROR MAIN CPU ERROR etc.	LCD CONTRAST NO ERROR MAIN CPU ERROR etc.	BACKLIGHT TIME 200 mm 0-999 mm	10.0 °C 0-99.9 °C	MPUI ROM Version 5 0-999	HART Polling Address 5 0-999				SOFT RESET	
SYSTEM DATA	V 6 DIGIT 10^-1mm ROUND 10^-1mm DISCARD	LAST SYSTEM ERR. Round 0.1 °C Round 0.25 °C Round 0.5 °C	LEV.CHANG.ALLO X.XXXX X.XXXXXX	TEMP.CHANG.ALLO	LEV.RETRY NO 00 XY X: V position Y: H position	TEMP.RETRY NO 01 XY X: V position Y: H position	02 XY X: V position Y: H position				
SYSTEM UNITS	V mm mm	TEMP.DATAROUND °C °C	V.C.F.DIGITS kl kl	Met-ton Met-ton	DISPLAY LINE 2 kg/cm2 kg/cm2	DISPLAY LINE 3 kg/cm3 kg/cm3	DISPLAY LINE 4 g/cm3 g/cm3			DENSITY UNIT	
		TEMPERATURE	VOLUME UNIT	MASS UNIT	PRESSURE UNIT						
	LENGTHUNIT										

[Tank Profile] (G4)

Primary Label	H0	H1	H2	H3	H4	H5	H6	H7	H8	H9
TANK PROFILE	V SPOT	2		0.0mm	99.9 mm	0 min	0 min	0 min		
	4 TANK PROFILE I/F PROFILE MAN. I/F PROFIL	2 - 16		0 - 99999.9	0.0 - 99.9	0 - 31	0 - 31	0 - 31		
	DENSITY MES. SEL	MES. POINT SELEC	DD/HH/MM	I/F MANU. LEVEL	LEVEL STB CNF RA	DISP HOLD TIME	HOLD TIME IN LIQU	OPE. STNBY TIME		
	V				0.0000 g/cm3	0.0°C				
TANK PROFILE OPE. STS	5									
	DENSITY 1-10	LEVEL CONDITION	OPE.TIME	AVERAGE DENSITY	AVERAGE TEMP.					
	V	0.0000 g/cm3	0.0000 g/cm3	0.0000 g/cm3	0.0000 g/cm3	0.0000 g/cm3	0.0000 g/cm3	0.0000 g/cm3	0.0000 g/cm3	0.0000 g/cm3
DENSITY 11-16		NO.2 DENSITY	NO.3 DENSITY	NO.4 DENSITY	NO.5 DENSITY	NO.6 DENSITY	NO.7 DENSITY	NO.8 DENSITY	NO.9 DENSITY	NO.10 DENSITY
	V	0.0000 g/cm3	0.0000 g/cm3	0.0000 g/cm3	0.0000 g/cm3	0.0000 g/cm3				
	7									
POSITION 1-10		NO.11 DENSITY	NO.12 DENSITY	NO.13 DENSITY	NO.14 DENSITY	NO.15 DENSITY	NO.16 DENSITY			
	V	0.0 mm	0.0 mm	0.0 mm	0.0 mm	0.0 mm	0.0 mm	0.0 mm	0.0 mm	0.0 mm
	8									
POSITION 11-16		NO.1 POSITION	NO.2 POSITION	NO.3 POSITION	NO.4 POSITION	NO.5 POSITION	NO.6 POSITION	NO.7 POSITION	NO.8 POSITION	NO.9 POSITION
	V									
	9									
		NO.11 POSITION	NO.12 POSITION	NO.13 POSITION	NO.14 POSITION	NO.15 POSITION	NO.16 POSITION			

[I/F Profile] (G5)

Primary Label	H0	H1	H2	H3	H4	H5	H6	H7	H8	H9
V I/F PROFILE 4										
V I/F PROFILE OPE. STS 5			DD/HH/MM	0.0 mm	0.0000 g/cm ³	0.0 °C				
V DENSITY 1-10 6	OPE. STATUS 0.0000 g/cm ³	LEVEL CONDITION 0.0000 g/cm ³	OP. TIME 0.0000 g/cm ³	I/F LEVEL 0.0000 g/cm ³	AVERAGE DENSITY 0.0000 g/cm ³	AVERAGE TEMP. 0.0000 g/cm ³	0.0000 g/cm ³	0.0000 g/cm ³	0.0000 g/cm ³	0.0000 g/cm ³
V DENSITY 11-16 7	NO.1 DENSITY 0.0000 g/cm ³	NO.2 DENSITY 0.0000 g/cm ³	NO.3 DENSITY 0.0000 g/cm ³	NO.4 DENSITY 0.0000 g/cm ³	NO.5 DENSITY 0.0000 g/cm ³	NO.6 DENSITY 0.0000 g/cm ³	NO.7 DENSITY	NO.8 DENSITY	NO.9 DENSITY	NO.10 DENSITY
V POSITION 1-10 8	NO.11 DENSITY 0.0 mm	NO.12 DENSITY 0.0 mm	NO.13 DENSITY 0.0 mm	NO.14 DENSITY 0.0 mm	NO.15 DENSITY 0.0 mm	NO.16 DENSITY 0.0 mm	0.0 mm	0.0 mm	0.0 mm	0.0 mm
V POSITION 11-16 9	NO.1 POSITION 0.0 mm	NO.2 POSITION 0.0 mm	NO.3 POSITION 0.0 mm	NO.4 POSITION 0.0 mm	NO.5 POSITION 0.0 mm	NO.6 POSITION 0.0 mm	NO.7 POSITION	NO.8 POSITION	NO.9 POSITION	NO.10 POSITION
	NO.11 POSITION	NO.12 POSITION	NO.13 POSITION	NO.14 POSITION	NO.15 POSITION	NO.16 POSITION				

6 Initial Adjustment

In the Tank computer NRM 571 requires all basic data required for operations to be registered. The default value (the initial values) are written in "5. Matrix Table". The set values should be changed as dictated by user needs. The basic method for setting these values is summarized below. In the description, [XXX] is the matrix position number.

Please refer to "5. Matrix table" and Appendix A. Matrix Detail

If you register Calculation method, alarm process, and error process setting, please refer to Appendix B (calculation method setting), Appendix D (alarm process setting), and Appendix E (error process setting).

Power-on

- Turn on power after checking specification and connections.
(refer to delivery specification or "4.1 Preparation for operation")
- When the NRM is powered, the LCD displays "Main display"

6.1 Basic Setting Items and Methods

- ACCESS CODE Setting
- Selecting Dynamic Matrix
- Mode Switch
- Calendar Setting
- Custom HOME Position Setting

6.1.1 ACCESS CODE Setting [039]

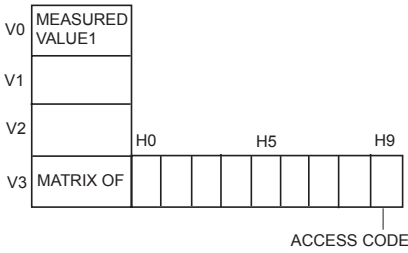
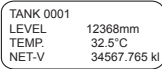
Item	Procedure	Remarks
<p style="text-align: center;">Static Matrix</p> 	 <p>From Tank 1 Home position</p> <ol style="list-style-type: none"> 1. Press [E]. (enter matrix) [00_]MEASURED VALUE 1 2. Press + 3 times. (go down) [03_]MATRIX OF 3. Press E 3 times. (go right) [039]ACCESS CODE 4. Set value "99" using + and -. 5. Press E to register the setting. The screen gose back to [03_]MATRIX OF 	<p>Note!</p> <p>Remember to put the access code back to 0 when all the setting is done.</p>

6.1.2 Selecting dynamic Matrix [030]

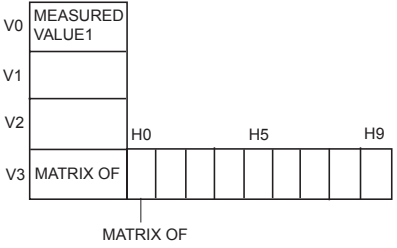
Item	Procedure	Remarks
<p style="text-align: center;">Static Matrix</p> 	<ol style="list-style-type: none"> At [030]MATRIX OF, select "VOL.CALCULATION" using + or -. Press [E] to register the setting. The screen moves to [031]GAUGE MATRIX 	<p>Note! When selecting Dynamic Matrix, always go to [030] MATRIX OF to choose the appropriate Matrix Group.</p> <p>Dynamic Matrices are; G1 VOL. CALCULATION [1XX] G2 OUTPUT [2XX] G3 SYSTEM DATA [3XX] G4 TANK PROFILE DATA [4XX] G5 I/F PROFILE DATA [5XX]</p>

6.1.3 Mode Switch [150]

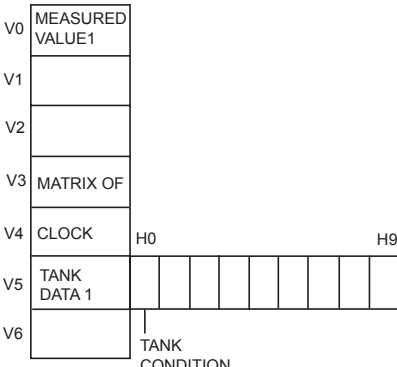
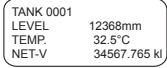
Item	Procedure	Remarks
<p style="text-align: center;">Dynamic Matrix: VOL.CALCULATION</p> 	 <ol style="list-style-type: none"> From Tank 1 HOME position Press [E]. (enter matrix) [00_]MEASURED VALUE 1 Press + 3 times. (go down) [03_]MATRIX OF Press E 3 times. (go right) [039]ACCESS CODE Set value "99" using + and -. Press E to register the setting. The screen gose back to [03_]MATRIX OF 	<p>Note! The Matrix has two modes. One is ,maintenance mode, the other is operation mode. When the data needs to be modified, always switch mode to "MAINTENANCE"(default setting is maintenance). After all the setting, remember to change mode to NORMAL OPERATION.</p>

6.1.4 Calender setting [341] to [346]

Item	Procedure	Remarks
<p style="text-align: center;">Static Matrix</p>	<ol style="list-style-type: none"> At [030]MATRIX OF, select "VOL.CALCULATION" using + or -. At [34_] CLOCK, go to [341] YEAR SETTING, press [E] twice. Set the last 2 digits of the current year using + or -. Press [E] to register the setting. Then set the month, data, hour, minute and second in the same manner. 	<p>Note! Always press [E] after selecting or setting value.</p>

6.1.5 Custom HOME Position Setting

Data that appear at HOME position (Normal Operation mode) can be selected by providing Display Code at the Matrix Positions [384]-[386].

- Set display line 2 in [384]
- Set display line 3 in [385]
- Set display line 4 in [386]

HOME Position Display Code List

CODE	ITEM	LCD SCREEN	MEMO
00	LEVEL	LEVEL 99999.9 mm	Sensor Data
		LEVEL M 99999.9 mm	Manual Setting Data
01	TEMPERATURE	TEMP. +/- 999.99°C	Sensor Data
		TEMP. M +/- 999.99°C	Manual Setting Data
02	GROSS VOLUME	GV C999999.999 kl	Calculation data only
03	NET VOLUME	NV C999999.999 kl	Calculation data only
04	MASS	MASS C99999.999t	Calculation data only
05	DENSITY	DEN t 9.9999 g/cm ³	Sensor Data
06	PEF. DENSITY	DEN 9.9999 g/cm ³	Sensor Data
		DEN M9.9999 g/cm ³	Manual Setting Data
07	WATER LEVEL	Wtriv 99999.9 mm	Sensor Data
		Wtriv M 99999.9 mm	Manual Data
11	BOTTOM LEVEL	BOTTOM 99999.9 mm	Sensor Data



Note!
Users can select how to display 10-1 mm and 10-1oC. Refer to Appendix B "1. Data Rounding" for details.

ex. : Select LEVEL, NET VOLUME, <ASS for display line 2,3 and 4.

At [384], select 00 for LEVEL.
 At [385], select 03 for NET VOLUME.
 At [386], select 04 for MASS.

6.2 Communication Setting with Sensor

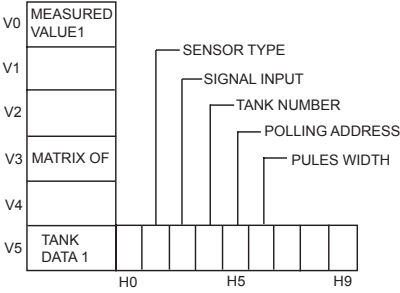
Item	Procedure	Remarks															
<p style="text-align: center;">Matrix: VOL.CALCULATION</p>  <p style="text-align: center;">Polling Address</p> <table border="1" data-bbox="520 1016 906 1227"> <thead> <tr> <th>Terminal block</th> <th>Loop No.</th> <th>Polling Address</th> </tr> </thead> <tbody> <tr> <td>1 - 2</td> <td>0</td> <td>0 - 99</td> </tr> <tr> <td>3 - 4</td> <td>1</td> <td>0 - 99</td> </tr> <tr> <td>5 - 6</td> <td>2</td> <td>0 - 99</td> </tr> <tr> <td>7 - 8</td> <td>3</td> <td>0 - 99</td> </tr> </tbody> </table>	Terminal block	Loop No.	Polling Address	1 - 2	0	0 - 99	3 - 4	1	0 - 99	5 - 6	2	0 - 99	7 - 8	3	0 - 99	<ol style="list-style-type: none"> 1. At [030]MATRIX OF, select "VOL.CALCULATION" using +or -. 2. At [151] SENSOR TYPE, select from NMS, TGM or TMD. 3. At [152] SIGNAL INPUT, select from MDP or V1. 4. At [153] TANK NUMBER, set the tank number for selected tank. 5. Set the [154] POLLING ADDRESS. 	<p>[151] SENSOR TYPE NMS1: higher than V4. 0x NMS2: between NMS1 & NMS3 NMS: lower than V2. 2x TGM: TGM 3000, 4000 TMD: TMD, MS, MX</p> <p>[152] SIGNAL INPUT See the combination table below.</p> <p>TGM4000 and TMD are fixed with ROM at the side of sensor, so they require the same setting sfter confirmation (using HHT, set them mode 13 and item 5.)</p> <p>[153]TANK UNMBER Tank number is set for your reference. It can be set in 4 digits.</p> <p>Note! Do not set a same Tank Number for different page.</p> <p>[154]POLLING ADDRESS The address can be set from 000 to 399.</p> <p>[155]PULSE WIDTH Set appropriate pulse width for V1 protocol. (V1 is selected in [152]SIGNAL INPUT) Set value x 4 micro sec.</p>
Terminal block	Loop No.	Polling Address															
1 - 2	0	0 - 99															
3 - 4	1	0 - 99															
5 - 6	2	0 - 99															
7 - 8	3	0 - 99															

6.3 Communication Setting with Host

Item	Procedure	Remarks
<p style="text-align: center;">Dynamic Matrix: SYSTEM DATA</p>	<ol style="list-style-type: none"> 1. At [350]Communication, select from NONE, MDP, BBB, ZA672, or MODBUS (RTU) then press E. 2. At [351] BAUD RATE, select from 19200, 9600, 2400 or 4800 BPS and press E. 3. At [352] DATA LENGTH, select 7 or 8 bits and press E. 4. At [353] PARITY, select from NONE EVEN or ODD and press E. 5. At [354] STOP BIT, select either ONE STOP BIT or TWO STOP BITS and press E. 6. (For MODBUS Protocol only) At [359] MODBUS ADDRESS, set a value from 1 to 247 and press E. 	<p>Settings in [350] to [354] should be same as the host's setting. For setting detail, please refer to the host's operating manual.</p> <p>Integration of multiple NRM is only possible with MODBUS communication. As for MDP, BBB only 1 NRM can be connected to PC.</p> <p>[359]MODBUS ADDRESS, MODBUS ADDRESS is the NRM address setting so that the MODBUS host will understand which NRM to send messages. Usually, address is set 1 for NRM 1, 2 for NRM 2. This means that maximum of 247 NRM can be connected to the host.</p>

7 Other Functions

■ Reset Function [349] DEFAULT VALUES

Reset function is used when set values want to be reset to default values.

- NO RESET: Usual setting.
- RESET ALL TANKS: Reset all tank's matrix values to default values.
Enabled if all tanks are in maintenance mode.
- RESET CURR.TANK: Reset current tank's matrix values to default values.

■ Language[360] LANGUAGE

- Select language either English or Japanese.
- Japanese will be displayed in katakana.

■ LCD Contrast adjustment function [361] LCD CONTRAST

- LCD contrast function is to adjust the contrast of the display.
- Press [+] to adjust the display to be darker.
- Press [-] to adjust the display to be lighter.

■ LCD CHECK function [361] LCD CONTRAST

LCD check functions is a function to check whether all LCD pixels are properly displayed.

1. press [+] or [-] to show "LCD CHECK".
 2. Press [E]
 3. Pixels for all displayed character fonts light for three seconds, then fade in the next three seconds.
- Diagnosis: LCD is working fine if all pixels are shown.

■ Set the back light time [362] BACKLIGHT TIME

Backlight is on when the machine is activated.

The function is to decide how many minutes after the last operation until the backlight turns itself off. Time can be set between 0 to 999(minutes).

Set the value with [+] and [-]key.

LCD display back to HOME position, at the same time the backlight turns itself off.

7.1 FreeScan List & V1 Communication specifications

7.1.1 V1 Communication

In the NRM V1 communication, usually the data is collected using "ZO telegram" FreeScan.

7.1.2 When accessing to the matrix data, R/S telegram is used.

7.1.3 [151] SENSOR TYPE setting and VI Communication

[151] SENSOR TYPE	Contents
NMS 1	Select when connecting NMS Ver. 4.0x higher
NMS 2	Select when connecting NMS Ver. 2.2x higher
NMS 3	Select when connecting Ver. 2.2 lower
TGM	Select when connecting TGM3000, TGM4000
TMD	Select when connecting TMD, MS and MX

Please setting NMS 1 because above setting is not used in NRM 571 Ver. 4.00.

7.1.4 [152] SIGNAL INPUT setting and V1 Communication

7.1.4.1 VI : when communicating with sensor, V1 communication type is used

G:V:H	Contents
[144]: MANUAL GAS TEMP.	When [-100.0] or [-200.0] is set , the data is requested with R telegram in accordance with the setting of [[148] SELECT GAS TEMP. SCAN]. When other value is set , the data is handled with manual input.
[145] MANUAL GAS PRESS.	When [-1000] is set, the data is requested with R telegram in accordance with the setting of [[149] SELECT GAS PRESS. SCAN]. When other value is set , the data is handled with manual input.
[148] SELECT GAS TEMP. SCAN	[Device 1 Step Temp.] : Mode 1 : Item 2 [Gas Average Temp.] : Mod 1 : Item 4
[149] SELECT GAS PRESS. SCAN	[GAS PRESS. MO1,I03] : Mode 1 : Item 3 [GAS PRESS. M60, I04] : Mode 60 : Item 4

Scan Interval: every ten ZO FreeScan, the above telegram request is sent.

- **Upper Density measurement:**

During execution of the upper density measurement, when gauge status changed into "STOP" and the measurement is deemed as completed operation, the measuring value is collected by sending level measuring command and R telegram "Mode 0 : Item 6" (One-shot Issue).

- **Middle Density measurement:**

When measuring the middle density, when gauge status changed into "STOP" and the measurement is deemed as completed operation, the measuring value is collected by sending level measuring command and R telegram "Mode 0 : Item 7" (One-shot Issue).

- **Lower Density measurement:**

When measuring the lower density, when gauge status changed into "STOP" and the measurement is deemed as completed operation, the measuring value is collected by sending level measuring command and R telegram "Mode 0 : Item 8" (One-shot Issue).

- **Upper interface measurement:**

During execution of the upper interface measurement, when gauge status is Interface Measurement and Balance, the measurement is deemed as completed operation, the measuring value is collected by sending level measuring command and R telegram "Mode 13 : Item 15" (One-shot Issue).

- **Middle interface measurement:**

During execution of the middle interface measurement, when gauge status is Interface Measurement and Balance, the measurement is deemed as completed operation, the measuring value is collected by sending level measuring command and R telegram "Mode 0 : Item 4" (One-shot Issue).

- **Lower interface measurement:**

During execution of the lower interface measurement, when gauge status is Interface Measurement and Balance, the measurement is deemed as completed operation, the measuring value is collected by sending level measuring command and R telegram "Mode 0 : Item 5" (One-shot Issue).

- **Density profile and Interface profile:**

During execution of profile processing, the following Freestone is executed every ten ZO FreeScan due to check the processing status.

- Density profile: [450] Mode 48: Item 1
- Interface profile: [550] Mode 54: Item 1

- **When the profile processing completed normally, measuring data collecting is processed by the following order.**

Density profile			Interface profile		
G:V:H	MODE	ITEM	G:V:H	MODE	ITEM
450 to 459	48	2 to 6	550 to 559	54	2 to 6
460 to 469	49	1 to 10	560 to 569	51	1 to 10
470 to 475	50	1 to 6	570 to 575	52	1 to 6
480 to 489	55	1 to 10	580 to 589	57	1 to 10
490 to 495	56	1 to 6	590 to 595	58	1 to 6

In R telegram, all data is sent continuously.

- **Writing of the profile processing data**

When the data writing is requested for the following matrix, setting data for the profile processing is written by sending S telegram.

G:V:H	MODE	ITEM
440 to 447	47	1 to 8

In S telegram, all data is sent continuously.

7.1.4.2 MDP : when communicating with Sensor, MDP is used.

7.1.4.3 TSM_V1: Between NRM and the Tank Side Monitor are performed communication using V1 communication type.

- **When setting on "TSM_V1", Free Scan collecting is processed for upper density data and interface data.**

	MODE	ITEM
Upper density	13	11
Upper interface	13	15

7.1.4.4 TGM_V1:Between NRM and the TGM are performed communication using V1 communication type.

- **Upper density measurement**

During execution of the upper density measurement, when gauge status changed into "STOP" and the measurement is deemed as completed operation, the measuring value is collected by sending level measuring command and R telegram "Mode 13 : Item 11" (One-shot Issue).

- **Middle density measurement**

During execution of the middle density measurement, when gauge status changed into "STOP" and the measurement is deemed as completed operation, the measuring value is collected by sending level measuring command and R telegram "Mode 13 : Item 12" (One-shot Issue).

- **Upper interface measurement**

During execution of the upper interface measurement, when gauge status is Interface Measurement and Balance, measurement is deemed as completed operation, the measuring value is collected by sending level measuring command and R telegram "Mode 0 : Item 4" (One-shot Issue).

- **Bottom measurement**

During execution of the bottom measurement, when gauge status is Interface Measurement and Balance, measurement is deemed as completed operation, the measuring value is collected by sending level measuring command and R telegram "Mode 13 : Item 16" (One-shot Issue).

Note!
 After sending "ZO R/Z telegram", if normally data could not receive even 10 error retry, it is processed as communication error.

Free Scan Sequence

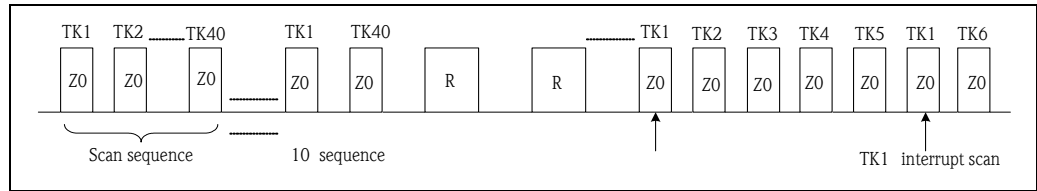

Fig.15 Free Scan Sequence

The measurement operation and writing request issue R telegram soon after receiving a command. The page that LCD is displayed (selected) performs the scan interrupt (every ZO 5 times).

7.1.5 TANK No. and Page No.

In the NRM571, basic data, setting value and so on are controlled by "Page No." locked. "TANK No." is used to select an appropriate tank from HOME display and user-configurable.

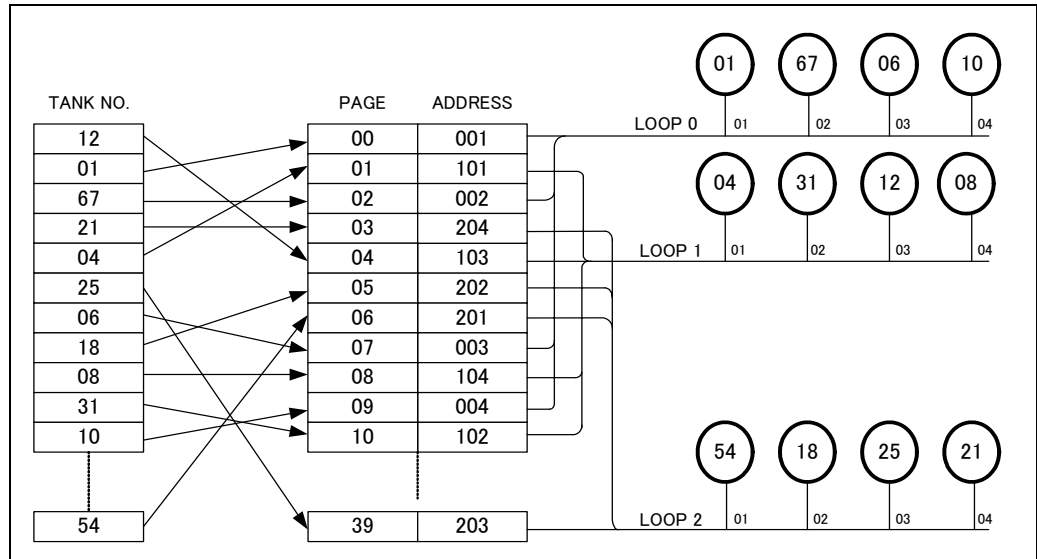



Fig.16 TANK No. and Page No.

Note!
 In the above example, "Tank No." is assigned to "Page No. : 01" and registered with [Sensor address: 101]. Please be careful not to assign the same "Tank No" to the different "Page".

7.1.6 Density profile processing sequence

- Please set up each value for [441] to [447] after selecting [TANK PROFILE or I/F PROFILE or MANU I/F PROFILE] at [440: DENSITY ME. SELECT].

Note!
 This is available for only profile specification for the NMS.

- When all of profile beginning conditions for the NMS are met, the measuring operation will start.
- When [OPE. STATUS] turns from "2: IN OPERATION" to "5: END/ABNORMAL", measurement error is deemed as completed operation and the density profile processing is terminated. When [OPE. STATUS] turns from "2: IN OPERATION" to "5: END/NORMAL", measurement is deemed as normally completed operation and writing of each measuring data is started.



Note!

Please input [STOP] operating, when interrupting the processing.

7.1.7 Others

Initialization of setting data

[369] SOFT RESET: Only "Software Reset" runs and the data initialization is not performed.

[349] DEFAULT VALUES;

- "RESET CURR. TANK" : the selected page data is initialized.
- "RESET ALL TANK" : all page data is initialized.

When turning on the NRM while pressing [SERECT] key and [5] key, all page data is initialized.

Data display page selection

Tank number is usually input at HOME display.

It is possible to move to the previous and next page by pressing [+] or [-] key, while pressing [SELECT] key.

8 Troubleshooting

8.1 When setting the same tank No. to different pages

Example: when setting in mistake the tank No. 2 of page 1 for tank No. 1

Page	Tank No.	Correct Tank No.	Address
0	1	1	001
1	1 (wrong No.)	2	002

If this is the case, it would be impossible to call up original tank No.2.
Please use the following method to cancel.

- If the wrong number (double setting) is clear

Solution 1 (if duplicate, Tank Number is known)

	(key operation)	(display) (normal operating)
1. Select Tank 1 (from example)	<div style="display: inline-block; border: 1px solid black; border-radius: 50%; width: 30px; height: 30px; text-align: center; line-height: 30px; margin-right: 10px;">1</div> <div style="display: inline-block; border: 1px solid black; border-radius: 50%; width: 30px; height: 30px; text-align: center; line-height: 30px;">Select</div>	Tank No. 0001 Level 3354mm
		(During doing maintenance)
		Tank No. 0001 In Maintenance
2. While holding down Select key press + key once	<div style="display: inline-block; border: 1px solid black; border-radius: 50%; width: 30px; height: 30px; text-align: center; line-height: 30px; margin-right: 10px;">Select (Hold)</div> <div style="display: inline-block; border: 1px solid black; border-radius: 50%; width: 30px; height: 30px; text-align: center; line-height: 30px;">+</div>	Tank No. 0001 In Maintenance
3. Press plus (E) key one time to enter matrix.	<div style="display: inline-block; border: 1px solid black; border-radius: 50%; width: 30px; height: 30px; text-align: center; line-height: 30px;">E</div>	Page No. 1 Measured Value 1
4. Press + key 5 times	<div style="display: inline-block; border: 1px solid black; border-radius: 50%; width: 30px; height: 30px; text-align: center; line-height: 30px; margin-right: 10px;">+</div> <div style="display: inline-block; vertical-align: middle;">(5 x)</div>	Page No. 01 Tank Data 1
5. Press E key, check Tank Condition. Press + key to set "Maintenance" if necessary.	<div style="display: inline-block; border: 1px solid black; border-radius: 50%; width: 30px; height: 30px; text-align: center; line-height: 30px;">E</div>	Page: 1 Tank: 1 Maintenance Tank Condition
6. Press E key 3 more times	<div style="display: inline-block; border: 1px solid black; border-radius: 50%; width: 30px; height: 30px; text-align: center; line-height: 30px; margin-right: 10px;">E</div> <div style="display: inline-block; vertical-align: middle;">(3 x)</div>	Page: 1 Tank: 1 0001 Tank Number
7. Correct the tank number using the + or - key, then press E key.	<div style="display: inline-block; border: 1px solid black; border-radius: 50%; width: 30px; height: 30px; text-align: center; line-height: 30px; margin-right: 10px;">+/-</div> <div style="display: inline-block; border: 1px solid black; border-radius: 50%; width: 30px; height: 30px; text-align: center; line-height: 30px;">E</div>	Page: 1 Tank: 1 0001 → 0002 Tank Number
8. Press and hold E key for 3 seconds, return to Home Position.	<div style="display: inline-block; border: 1px solid black; border-radius: 50%; width: 30px; height: 30px; text-align: center; line-height: 30px; margin-right: 10px;">E</div> <div style="display: inline-block; vertical-align: middle;">(3 sec.)</div>	Tank No. 0002 In Maintenance

Solution 2 (if duplicate, Tank Number is unknown)

Same as above, except select Tank Number corresponding to Page 0.
 Follow steps above to check each tank, one-by-one.
 Write the Page Number and Tank Number in the table.
 When you have identified the duplicate Tank Number, change it to a non-duplicate Tank Number.

Fig. 17 Troubleshooting

8.2 Tank Data Base of NRM

NRM each have a Tank Data Base consisting of matrix data that is addressed via “Page” number (refer to the following diagram). The NRM CPU system addresses the Page number (not Tank number) internally. On the other hand operator addresses matrix data via “Tank Number” for Man-Machine-Interface because of easy operation. However the tank number data is just a set data by operator in to the matrix G1V5H3 and can be re-set any time by operator. Only way for the operator to access the matrix is to use tank number data and it is very important to keep the tank number.

If you miss the number, you cannot access the matrix any more.

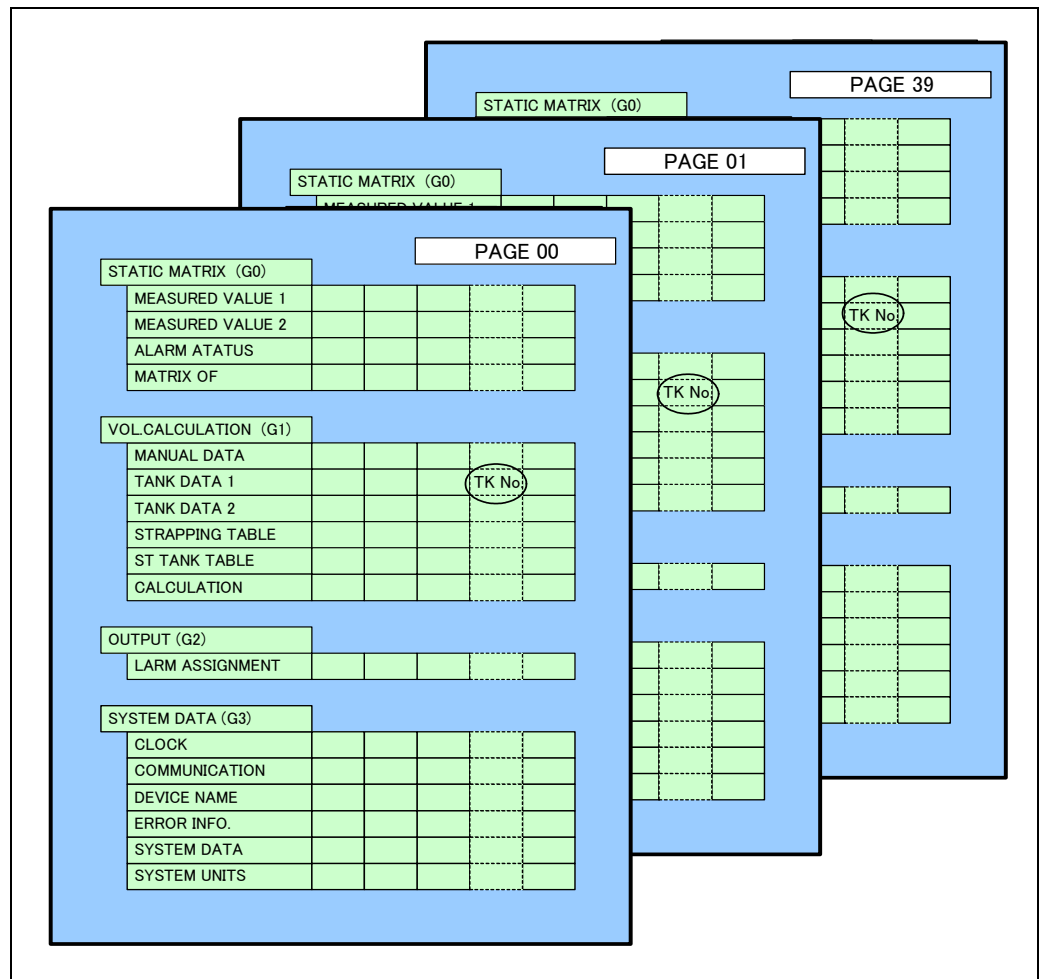

Fig. 18 Database structure

8.3 Development and Spare parts

The Endress+Hauser repair concept assumes that the measuring devices have a modular design and that customers are able to undertake repairs themselves. Spare parts are contained in suitable kits. They contain the related replacement instructions. For more information on service and spare parts, contact the Service department at Endress+ Hauser Japan.

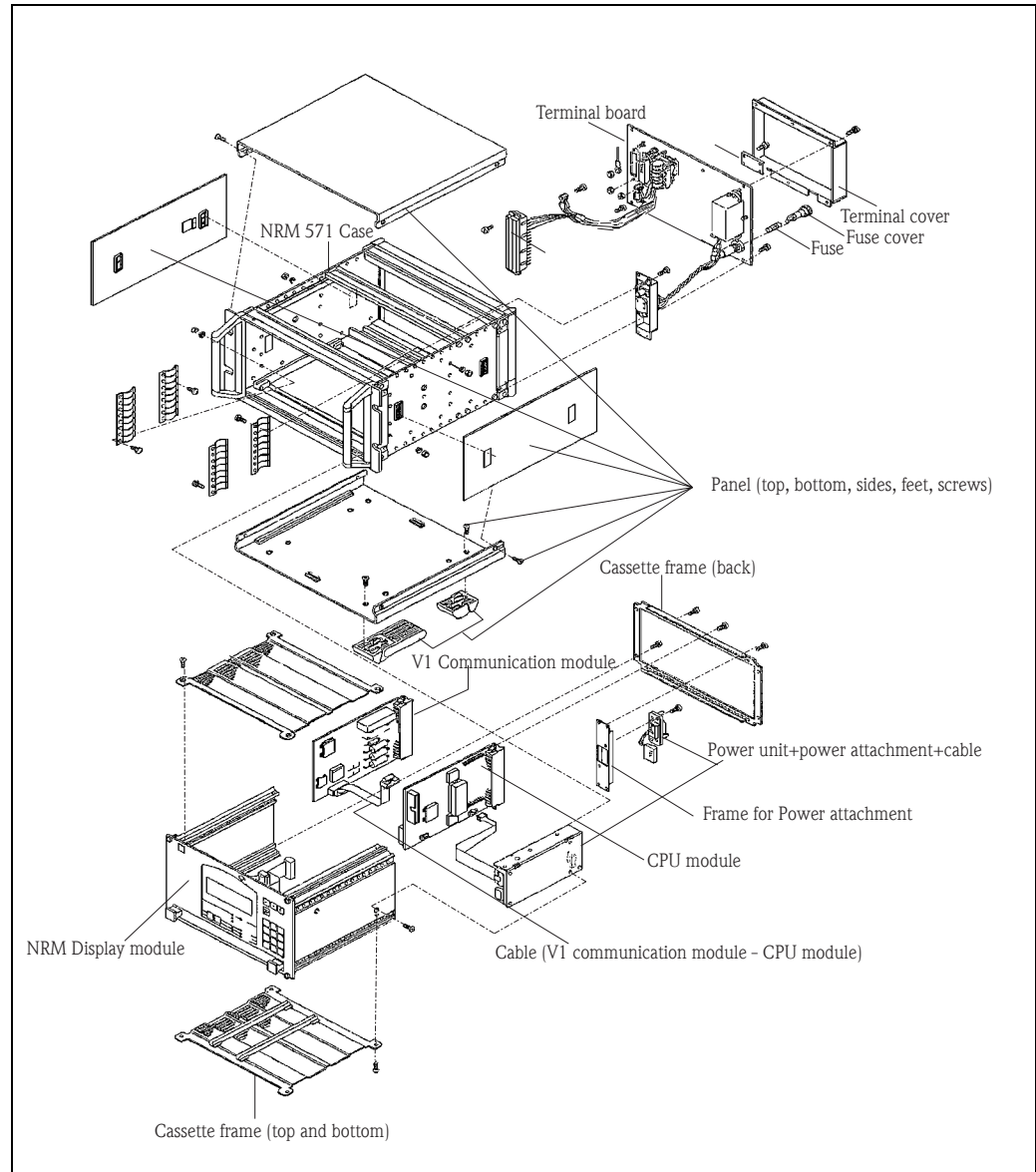

Fig. 19 NRM development

9 Appendix A

9.1 Matrix Details

Matrix group	Function group	Item	Access Code	Short description	Default value	Set Select Display	Possible settings, selections, or display	Matrix position [GVH]
STATIC MATRIX (This word is not shown.)	MEASURED VALUE 1	MEASURED LEVEL	NONE	Display current sensor level or the value manually entered at [140].	MEASURED VALUE	Display	0 - 99999 mm	000
		LIQUID TEMP.	NONE	Display current average liquid temperature or the value manually entered at [141].	MEASURED VALUE	Display	-99.9 - +300.0 °C	001
		GROSS VOLUME	NONE	Gross volume calculated at NRM.	0.000 kl	Display	0.000 - 999999.999 kl	002
		NET VOLUME	NONE	Net volume calculated at NRM.	0.000 kl	Display	0.000 - 999999.999 kl	003
		MASS	NONE	MASS volume calculated at NRM.	0.000 t	Display	0.000 - 999999.999 t	004
		DENSITY	NONE	Display latest measured liquid density.	1.0000 g/cm ³	Display	0.0000 - 9.9999 g/cm ³	005
		REF. DENSITY	NONE	Display manually entered value at [142] or reference density converted from measured data. Value in this matrix is used for calculation.	1.0000 g/cm ³	Display	0.0000 - 9.9999 g/cm ³	006
		WATER LEVEL	NONE	Display current water level (upper interface level) or value manually entered at [143].	0 mm	Display	0 - 99999 mm	007
		GAS TEMPERATURE	NONE	Display current gas temperature or value manually entered at [144].	0.0 °C	Display	0.0 °C	008
		GAS PRESSURE	NONE	Display current gas pressure or value manually entered at [145].	1.000 kg/cm ²	Display	0 - 99.999 kg/cm ²	009
		OPERATING MODE	99	Operate NMS or TGM level gauge. The possible operation commands depend on sensor type and specification. Refer to "6.3.3 Difference in Operation" for possible operation.		Select	LEVEL UP STOP BOTTOM LEVEL UPPER INT.LEV. MID.INT.LEVEL UPPER DENSITY MIDDLE DENSITY DENSITY BOTTOM	010
		STATUS DATA	BOTTOM LEVEL	99	Data measured by NMS or TGM.	0 mm	Display	
STATUS DATA	99		Status data of equipment connected to TGM or TMD. Each character represents status (1-8). 0 means OFF, 1 means ON. In the example below, status 3 is ON. 0000 0100	00000000	Display		012	

Matrix group	Function group	Item	Access Code	Short description	Default value	Set Select Display	Possible settings, selections, or display	Matrix position [GVH]
STATIC MATRIX (This word is not shown.)	MEASURED VALUE 2	GAUGE STATUS	NONE	Shows where the displacer is (NMS, TGM only).	NOT DEFINED	Display	REFERENCE UP DOWN STOP LEVEL UPPER INT.LEV. MID.INT.LEV. BOTTOM LEVEL UPPER DENSITY MIDDLE DENSITY DENSITY BOTTOM CALIBRATION	013
		BALANCING STATUS	NONE	Balance of the displacer.	BALANCED	Display	BALANCED UNBALANCED	014
		MIDD. INTERF.LEV.	99	Middle interface data measured by NMS.	0 mm	Display		016
		MIDDLE DENSITY	99	Middle density data measured by NMS.	9.9999 g/cm ³	Display		017
		DENSITY BOTTOM	99	Bottom density data measured by NMS.	9.9999 g/cm ³	Display		018
	ALARM STATUS	ALARM DATA 1	NONE	Current data 1 0 0 5 L 3 H N N Data for alarm 4 Type of alarm 4 Data for alarm 3 Type of alarm 3 Data for alarm 2 Type of alarm 2 Data for alarm 1 Type of alarm 1	NN NN NN NN	Display		020

Matrix group	Function group	Item	Access Code	Short description	Default value	Set Select Display	Possible settings, selections, or display	Matrix position [GVH]
STATIC MATRIX (This word is not shown.)	ALARM STATUS	ALARM DATA 2	NONE	Current data 2 0 0 5 L 3 H N N Data for alarm 8 Type of alarm 8 Data for alarm 7 Type of alarm 7 Data for alarm 6 Type of alarm 6 Data for alarm 5 Type of alarm 5	NN NN NN NN	Display		021
		LAST ALARM DATA	NONE		-	Display		022
	LAST COMM. ERROR	VI COMMUNICATION ERR.	NONE	Display a current error in communication between NRM and sensor. YY/MM/DD HH : MM Year, Month, day, hour and minute of the issue. ERROR No. eee: error code	-	Display	1: start code err. 2: total mark err. 3: data comp err. 4: select err. 5: level bcd err. 6: level jump err. 7: Temp. jump err. 8: V1 STX err. 9: V1 parity err. 10: V1 address err. 11: V1 data address err. 12: V1 ETX err. 13: V1 GHC err.	023
		LAST COMM. ERROR	NONE	The [+] and [-] keys can be used to display up to 10 pieces of historical data for communication errors between NRM and sensor. Press [TANK SELECT] key to clear the history	-	Display	Same as above	024
		SENSOR ALARM	NONE	Store up to 10 alarms. The [+] and [-] keys can be used to display the alarms. YY/MM/DD HH :MM Year, month, day, hour, and minute of the issue.	-	Display	Event No. : contents 1: Alarm 1 ON 2: Alarm 2 ON 3: Alarm 1, Alarm 2 ON	025

Matrix group	Function group	Item	Access Code	Short description	Default value	Set Select Display	Possible settings, selections, or display	Matrix position [GVH]
STATIC MATRIX (This word is not shown.)	ALARM STATUS	SENSOR ERROR	NONE	Stores up to 10 errors. (+) and (-) is used to display the alarms. YY/MM/DD HH : MM Year, month, day, hour, and minute of the issue ERROR No. eee : Error code. Press [tank SELECT] key to clear the history.		Display	0 : No Error 1 : Over Tension 2 : Under Tension 3 : Level A/D Error 4 : Level Error : Following Error	026
		V1 Comm. Num. Count	NONE	V1 communication count	Set	Display	Num. of Requests Num. of Error Num. of Time out	028
		SOFTWARE VERSION	NONE	Display main software version number.	###	Display	-	029
STATIC MATRIX (This word is not shown.)	MATRIX OF	MATRIX OF	NONE	Switch Dynamic matrix.	VOL. CALCULATION	Select	VOL. CALCULATION OUTPUT SYSTEM DATA TANK PROFILE DATA, I/F PROFILE DATA	030
		SELECT PAGE	NONE	Page number for HART DIRECT MODE (Packed HART)	00	Set	0 - 39	032
		HART DIRECT MODE	NONE	ON/OFF for HART DIRECT MODE	OFF	Set	ON /OFF	035
		ACCESS CODE	99	Number in 2 digits required to change NRM data.	00	Set	51, 99	039
		MANUAL LEVEL	99	Value can be entered manually. The set data is reflected in [000] MEASURED LEVEL. "-1mm" displays the measured data. *1	-1	Set	0 - 99999 mm	140
VOL. CALCULATION (This word is not shown.)	MANUAL DATA	MANUAL LIQUID TEMP.	99	Value can be entered manually. The set data is reflected in [001] LIQUID TEMP. "-100°C" displays the measured value. *1	-100	Set	-99.9 - +200.0 °C	141
		MANUAL DENSITY	99	Value can be entered manually. The set data is reflected in [006] REE.DENSITY. When entering "-1000" temperature equivalent conversion data for measuring density is reflected in [006]. If this is the case, you need to set up [199]15D .CALC. TAB. *1	1.0000	Set	0.0001 - 9.9999 g/cm ³	142
		MANUAL WATER LEV.	99	Value can be entered manually. The set data is reflected in [007] WATER LEVEL "-1mm" displays the measured value. *1	0	Set	0 - 99999 mm	143
		MANUAL GAS TEMP.	99	Value can be entered manually. When entering "-100" manually, Gas temp. for NMS HART DEVICE (1) is displayed. When entering "-200" manually, NMT average Gas temp. is displayed *Please refer to "FreeScan List" about the scan interval. *1	0.0	Set	-99.9 - +200.0 °C	144

*1: Every time [TANK SELECT] key is pressed, [Enable]/[Disable] in manually data setting is switched.

Matrix group	Function group	Item	Access Code	Short description	Default value	Set Select Display	Possible settings, selections, or display	Matrix position [GVH]
VOL. CALCULATION (This word is not shown.)	MANUAL DATA	MANUAL GAS PRESS.	99	Value can be entered manually. When entering "-1000" manually, gas pressure for NMS HART DEVICE (2) is displayed. Please refer to "FreeScan List" about the scan interval. *1	1.000	Set	0 - 99.999 kg/cm ²	145
		MANUAL GAS DENS.	99	The set data is reflected in the calculation of spherical tank weight.	1.0000	Set	0.0001 - 9.9999 g/cm ³	146
		WATER CONTENT	99	Set the water content %. The value will be used to be deducted if GROSS VOL. or NET VOL is selected in [193] SUBTR.WATER CONT	0.000%	Set	0 - 99.999 %	147
		SELECT GAS. TEMP. SCAN	99	HART DEVICE 1: select the scan processing for Gas Temp. Only when [148] MANUAL GAS TEMP is "Disable", SELECT GAS TEMP. SCAN is displayed	Device 1 Stop Temp.	Set	Device 1 Spot Temp. Gas Average Temp.	148
		SELECT GAS. PRESS. SCAN	99	HART DEVICE 2: select the scan processing for Gas Pressure. Only when [149] MANUAL PRESS TEMP is "Disable", SELECT GAS PRESS. SCAN is displayed	GAS. PRESS. M01, I03	Select	GAS. PRESS. M01, I03 GAS. PRESS. M00, I04	149
		TANK CONDITION	99	MAINTENANCE: Maintenance mode. Various data settings can be changed. NORMAL OPERATION: Normal operation mode. No data can be changed in this condition.	MAINTENANCE	Select	MAINTENANCE NORMAL OPERATION	150
		SENSOR TYPE	99	Select sensor type. NMS1 _____ NMSV4.0x or higher NMS2 _____ NMSV2.2x or higher NMS3 _____ NMS V lower than 2.2x TGM _____ TGM4000, 3000 TMD _____ TMD, MS, MX Tank Side Monitor _____ NRF590	NMS1	Select	NMS1 NMS2 NMS3 TGM TMD Tank Side Monitor	151
		SIGNAL INPUT	99	Set a communication method for communication between NRM and sensor. TSM_V1: Select when connecting Tank Side Monitor NRF 590. TGM_V1: Select when connecting TGM.	0001-0040	Select	V1 MDP TSM_V1 TSM_TGM_V1	152
		TANK NUMBER	99	Set a tank number for each gauge (transmitter).	0001-0040	Set	0000 - 9999	153
		POLLING ADDRESS	99	Set a polling address used for communication with the sensor. XY: Set loop number in X, set sensor address in YY. Please refer to "Communication Setting with Sensor" for address number.	000	Set	Sensor communication 000 - 399	154
PULSE WIDTH	99	Enable pulse width to be changed if V1/MDP/DX is set for SIGNAL INPUT in [152] SIGNAL INPUT. Set value x 4 micro sec. *2	0	Set	0 - 99	155		
TANK CAPACITY	99	Set the total volume of the tank. Used to calculate spherical tank weight.	999999.999 kl	Set	0 - 999999.999 kl	156		

*1: Every time [TANK SELECT] key is pressed, [Enable]/[Disable] in manually data setting is switched.

*2: When connecting with NRF590, please set 20 and over in Pulse Width.

Matrix group	Function group	Item	Access Code	Short description	Default value	Set Select Display	Possible settings, selections, or display	Matrix position [GVH]
VOL. CALCULATION (This word is not shown.)	TANK DATA 1	TANK LEV. CORRECTO	99	Used to reduce the calculated gross volume level by a certain value.	0 mm	Set	0 - 99999 mm	157
		VOLUME CORRECTIO	99	Used to increase or reduce the volume by a certain value after gross volume is calculated.	0.000 kl	Set	0 +/- 999999,999 kl	158
		DENSITY CALIBR.	99	Used if the tank table prepared by the test association includes this description.	1.0000 g/cm ³	Set	0.001 - 9.9999 g/cm ³	159
	TANK DATA 2	FLOAT ROOF WEIGH	99	Set the weight of the floating roof. This is used to calculate the net volume of a floating roof tank for correction.	0.000000 t	Set	0 - 999,999999 t	160
		FLOAT ROOF LEVEL	99	Set a level so that the floating roof can be floated perfectly. This is used to calculate the net volume of a floating roof tank.	0 mm	Set	0 - 99999 mm	161
		VCF REF. TEMP.	99	Set a reference temperature if TABLE 6X is set in [194].	0.0 °C	Set	-100.0 - +300.0 °C	162
		VCF. FOR CHEMICAL	99	Set a conversion factor for chemicals if METHOD 1 or METHOD 2 is selected in [194].	0.00000000	Set	0 - 9.99999999	163
		TANK EXPAN. COEFF.	99	Set a tank expansion coefficient. This is used to correct tank expansion.	0.00000000	Set	0 - 9.99999999	164
		EXPAN REF. TEMP.	99	Set a tank expansion correction reference temperature. Used to correct tank expansion.	0.0 °C	Set	-100.0 - +300.0 °C	165
		MOL WEIGHT	99	Enter MOL weight value. The entered value is reflected in mass calculation if METHOD 4 is selected in [196].	0	Set	0 - 29	167
		WATER LEVEL TABL.	99	Set up to 30 strapping points for a water level table.	0 mm	Set	0 - 99999 mm	168
		STRAP WATER LEVEL	99	Set level in the water level table.	0.000 kl	Set	0 - 999,999 kl	169
		STRAP WATER VOL.	99	Set volume in the water level table.	0	Set	0 - 100	170
		TANK TABLE	NONE	Strapping points in the tank. Permits setting up to 100 points.	0 mm	Set	0 - 99999 mm	171
		STRAPPING LEVEL	99	Level in tank table	0.000 kl	Set	0 - 99999,999 kl	172
STR.VOL.UP.DGT	99	Volume in tank table (higher digits)	0.0x10 ⁻⁶ kl	Set	0 - 99999 X 10 ⁻⁶ kl	173		
STR.VOL.LO.DGT	99	Volume in tank table (lower digits)	0.000 kl	Set	0 - 99,999 kl	174		
NET AREA UP.DGT	99	Volume per 1 mm in tank table (higher digits). Used when GROSS VOL. CALCUL. is METHOD 2.	0.0x10 ⁻⁶ kl	Set	0 - 99999 X 10 ⁻⁶ kl	175		
NET AREA LO.DGT	99	Volume per 1 mm in tank table (lower digits). Used when GROSS VOL. CALCUL. is METHOD 2.						

Matrix group	Function group	Item	Access Code	Short description	Default value	Set Select Display	Possible settings, selections, or display	Matrix position [GVH]
VOL. CALCULATION (This word is not shown.)	ST TANK TABLE	ST CONSTANT P1	99	Set Constant P for the spherical tank in the tank table up to 4th decimal point.	0.0000	Set	-9,9999 - +9,9999	180
		ST CONSTANT P2	99	Set Constant P for the spherical tank in the tank table from 5th decimal point to 9th decimal point.	0.10^-9	Set	0 - +/- 99999	181
		ST CONSTANT Qn1	99	Set Constant Q (upper digits=up to 3rd decimal point) for the spherical tank.	0.000	Set	-999,999 - +999,999	182
		ST CONSTANT Qn2	99	Set Constant Q (lower digits=from 4th decimal point to 8th) for the spherical tank.	0.10^-8	Set	0 - +/- 99999	183
		ST CONSTANT Rn1	99	Set Constant R (upper digits=integer) for the spherical tank.	0	Set	-9999 - +9999	184
		ST CONSTANT Rn2	99	Set Constant R (lower digits=decimal) for the spherical tank.	0.10^-6	Set	0 - +/- 999999	185
		ST CONSTANT Sn1	99	Set Constant S (upper digits=integer) for the spherical tank.	0	Set	-99999 - +99999	186
		ST CONSTANT Sn2	99	Set Constant S (lower digits=decimal) for the spherical tank.	0.10^-5	Set	0 - +/- 99999	187
		CALCULATION	TANK TYPE	99	Select the tank shape from CRT (Cone Roof Tank), FRT (Floating Roof Tank) and ST (Spherical Tank). As for DRT (dome roof tank), and cylindrical tank select CRT. As for CFRT (Cone Floating Roof Tank), select FRT.	CRT	Select	CRT, FRT, ST
	GROSS VOL. CALCUL.		99	Set equations for gross volume. NONE ——— no calculation METHOD1 — calculate without calculation book METHOD2 — calculate with calculation book	NONE	Select	NONE METHOD 1 METHOD 2	191
	SUBTR. WATER LEV.		99	Set water volume (VW) calculation method. NONE—VW will not be deducted. GROSS VOL.— VW is deducted from gross volume. NET VOL.— VW is deducted from net volume.	NONE	Select	NONE GROSS VOL. NET VOL.	192
	SUBTR. WATER CONT		99	Set water content (V(BS/W)) calculation method. NONE—V(BS/W) will not be deducted. GROSS VOL.— V(BS/W) will be deducted from gross volume if value is set in [147]. NET VOL.— V(BS/W) will be deducted from net volume if value is set in [147].	NONE	Select	NONE GROSS VOL. NET VOL.	193

Matrix group	Function group	Item	Access Code	Short description	Default value	Set Select Display	Possible settings, or display selections, or display	Matrix position [GVH]
VOL. CALCULATION	CALCULATION	NET VOL.CALC.TAB.	99	Select equation for volume conversion factor. AROMATIC (300) = 300-350 °F AROMATIC (350) = 350-400 °F	NONE	Select	NONE TABLE 54A TABLE 54B TABLE 54D TABLE 54 TABLE 55 TABLE 6X BENZENE TOLUENE, XYLENE STYRENE, ORTHO XYLENE META XYLENE PARA XYLENE CYCLO HEXANE AROMATIC (300) AROMATIC (350) METHOD 1 METHOD 2	194
		NET VOL.CALCULAT.	99	Set equations for the net volume for FRT. METHOD 1 – Refer to equation (15) in App. B METHOD 2 – Refer to equation (16) in App. B	NONE	Select	METHOD 1 METHOD 2 METHOD 3	195
		MASS CALCULATION	99	Set equations for weight. These equations are mainly used for chemicals and liquefied gases.	NONE	Set	NONE METHOD 1 METHOD 2 METHOD 3 METHOD 4	196
		VOLUME DATA	99	Sets a method for processing ASTM T54A, T54B, and T54D.	API	Select	API JAPANESE	198
		D15.CALC.TAB	99	Select an appropriate table to convert the measured density to density at 15 °C. If the density at 15 °C is manually entered at [142], choose NONE.	NONE	Select	53A 53B 53D 53	199

Matrix group	Function group	Item	Access Code	Short description	Default value	Set Select Display	Possible settings, selections, or display	Matrix position [GVH]
OUTPUT (This word is not shown.)	ALARM ASSIGNMENT	ALARM SELECTION	99	Register pointers for alarm outputs. Eight types of alarms can be selected per tank.	0	Select	0 - 7	240
		ALARM ASSIGNMENT	99	Select type of alarm.	NONE	Select	NONE LEVEL TEMPERATURE GROSS VOLUME NET VOLUME MASS	241
SYSTEM DATA (This word is not shown.)	CLOCK	SET POINT	99	Not required if " NONE ", "TRANSMITTER H ", and "TRANSMITTER L " are selected in [241]	0	Set	0 - 99999 mm	242
		ALARM ASSIGNMENT	99	Not required if " NONE ", "TRANSMITTER H ", and "TRANSMITTER L " are selected in [241]	HIGH ALARM	Select	LOW ALARM HIGH ALARM	243
		CLOCK	99	YY/MM/DD/HH : MM	-	Display	-	340
		YEAR SETTING	99	Set the lower two digits of Year.	00	Set	00 - 99	341
		MONTH SETTING	99	Set the current month.	01	Set	01 - 12	342
		DATE SETTING	99	Set the current date.	01	Set	01 - 31	343
		HOUR SETTING	99	Set the current hour.	00	Set	00 - 23	344
		MINUTE SETTING	99	Set the current minute.	00	Set	00 - 59	345
		SECOND SETTING	99	Set the current second.	00	Set	00 - 59	346
		DEFAULT VALUES	99	RESET CURR.TANK means to restore all the data registered in current tank to default values. RESET ALL TANKS means to restore all the data in all tanks to default setting. This is enabled when all tanks are in the maintenance condition [150].	NO RESET	Select	NO RESET RESET CURR. TANK RESET ALL TANKS	349

Matrix group	Function group	Item	Access Code	Short description	Default value	Set Select Display	Possible settings, selections, or display	Matrix position [GVH]	
SYSTEM DATA (This word is not shown.)	COMMUNICATION	COMMUNICATION	0	Select a communication protocol with host.		Select	0: NONE 1: BBB 2: MDP 3: Modbus (NRM) 4: Modbus (float 1) 5: Modbus (float 2) 6: Modbus (MDP) 7: Modbus (density)	350	
		BAUD RATE	0	Select a proper baud rate.	9600 BPS	Select	19200 BPS 9600 BPS 2400 BPS 4800 BPS	351	
		DATA LENGTH	0	Select a data length.	8 BITS	Select	7 BITS 8 BITS	352	
		PARITY	0	Select a parity even or odd.	ODD	Select	NONE ODD EVEN	353	
		STOP BIT	0	Select one stop bit or two stop bit.	ONE STOP BIT	Select	ONE STOP BIT TWO STOP BIT	354	
		LEV. ALARM HYST.	99	Register a level alarm hysteresis value if level data is used to execute alarm processing.	0 mm	Set	0 - 999 mm	355	
		TEMP. ALARM HYST.	99	Register an alarm hysteresis value if temperature data is used to execute alarm processing.	0.0 °C	Set	0 - 99.9 °C	356	
		VOL. ALARM HYST.	99	Register an alarm hysteresis value if (gross and/or net) volume data is used to execute alarm processing.	0 kl	Set	0 - 99,999 kl	357	
		MASS ALARM HYST.	99	Register an alarm hysteresis value if weight data is used to execute alarm processing.	0.000 t	Set	0 - 99,999 ton	358	
		MODBUS ADDRESS	99	Set a MODBUS protocol slave address for host communication (RS232C).	1	Set	1 - 247	359	
		DEVICE NAME	LANGUAGE	99	Select ENGLISH or JAPANESE.	ENGLISH	Select	ENGLISH JAPANESE	360
			LCD CONTRAST	99	LCD contrast function: pressing + makes LCD darker, pressing - makes LCD lighter. LCD check function: when all the pixels are shown, press E to see if all pixels are properly displayed.	-	(Check)		361
			BACKLIGHT TIME	99	Set a value in minutes. Backlight turns itself off (X) minutes after last operation	1	Set	0 - 999	362
			SOFT. VER. SER. PLS	99	Software version for serial pulse (V1 module)	###	Display		364
			HART POLLING ADDRESS	99	Set HART Device Address used at the time of connecting with HART port ToF Tool.		Set	0 - 15	365

Matrix group	Function group	Item	Access Code	Short description	Default value	Set Select Display	Possible settings, or display selections, or display	Matrix position [GVH]
SYSTEM DATA (This word is not shown.)	ERROR INFO.	SYSTEM ERROR	NONE	Shows current NRM system error when it happens. This data can be seen from Host. Refer to appendix E for more information.	NO ERROR	Display	21 : V1 CPU ERROR 22 : MAIN CPU ERROR 23 : START 40 : START init 41 : START w/d 42 : START res.	370
		LAST SYSTEM ERR.	NONE	Shows latest system error occurred.	NO ERROR	Display	-	371
		LEV. CHANG. ALLOW	99	Sets a permitted limit for level variation. If this set value is exceeded, the retry set in [374] is executed.	200 mm	Set	0 - 999 mm	372
		TEMP. CHANG. ALLOW	99	Sets a permitted limit for temperature variation. If this set value is exceeded, the retry set in [375] is executed.	10.0 °C	Set	0 - 99.9 °C	373
		LEV. RETRY NO	99	If the number of continuous level variations exceeds this set value, it is considered an error.	5	Set	0 - 999	374
		TEMP. RETRY NO	99	If the number of continuous temperature variations exceeds this set value, it is considered an error.	5	Set	0 - 999	375
		LEVEL DATA ROUND	99	Sets a method for processing the first decimal place of level data obtained by the sensor.	10 ⁻¹ mm DISCARD	Select	10 ⁻¹ mm DISCARD 10 ⁻¹ mm ROUNDING NONE	380
		TEMP. DATA ROUND	99	Set a method for processing the first decimal place of temperature data.	0.1	Select	0.1 0.25 0.5	381
		V.C.F. DIGIT	99	Select volume conversion factor digit.	X.XXXX	Select	X.XXXX X.XXXXXX	382
		DISPLAY LINE 2.	99	Set the home position display for line 2. VH value change as + or - is pressed. Refer "8.1.5 Custom HOME Position Setting" for further description.	0100	Set	00 : LEVEL 01 : TEMPERATURE 02 : GROSS VOLUME 03 : NET VOLUME 04 : MASS 05 : DENSITY 06 : REFERENCE DENSITY 07 : WATER LEVEL 08 : GAS TEMPERATURE 09 : GAS PRESSURE 11 : BOTTOM LEVEL	384

Matrix group	Function group	Item	Access Code	Short description	Default value	Set Select Display	Possible settings, or display selections, or display	Matrix position [GVH]
SYSTEM DATA (This word is not shown.)	SYSTEM DATA	DISPLAY LINE 3	99	Set the home position display for line 3. VH value change as + or - is pressed. Refer "8.1.5 Custom HOME Position Setting" for further description.	0100	Set	00 : LEVEL 01 : TEMPERATURE 02 : GROSS VOLUME 03 : NET VOLUME 04 : MASS 05 : DENSITY 06 : REFERENCE DENSITY 07 : WATER LEVEL 08 : GAS TEMPERATURE 09 : GAS PRESSURE 11 : BOTTOM LEVEL	385
		DISPLAY LINE 4	99	Set the home position display for line 4. VH value change as + or - is pressed. Refer "8.1.5 Custom HOME Position Setting" for further description.	0000	Set	00 : LEVEL 01 : TEMPERATURE 02 : GROSS VOLUME 03 : NET VOLUME 04 : MASS 05 : DENSITY 06 : REFERENCE DENSITY 07 : WATER LEVEL 08 : GAS TEMPERATURE 09 : GAS PRESSURE 11 : BOTTOM LEVEL	386
SYSTEM DATA (This word is not shown.)	SYSTEM UNITS	LENGTH UNIT	NONE	Display only.	mm	Display	-	390
		TEMPERATURE UNIT	NONE	Display only.	°C	Display	-	391
		VOLUME UNIT	NONE	Display only.	kl	Display	-	392
		MASS UNIT	NONE	Display only.	t	Display	-	393
		PRESSURE UNIT	NONE	Display only.	kg/cm ²	Display	-	394
		DENSITY UNIT	NONE	Display only.	g/cm ³	Display	-	396

Matrix group	Function group	Item	Access Code	Short description	Default value	Set Select Display	Possible settings, or display selections, or display	Matrix position [GVH]	
TANK PROFILE DATA	TANK PROFILE	DENSITY MES. SELECT		Select the method for Density measurement processing *Basic setting related with Density profile should set in [44x] when selecting I/F PROFILE, MAN. I/F PROFILE.	0: SPOT	Select	0 : SPOT 1 : TANK PROFILE 2 : I/F PROFILE 3 : MANUAL I/F PROFILE	440	
		MEASURE POINT SELECT		Set the measurement point for Density profile processing.	2	Set	2 - 16	441	
		I/F MANUAL LEVEL		Level Value entered manually used for setting MANUAL I/F PROFILE .	0.0mm			0 - 99999.9	443
		LEVEL STB. CNF. RANGE		Start-up condition for Density profile measurement Set "Level stability CNF Range" * When setting 99.9mm, condition setting is not necessary .	2.0	Set		0.0 - 99.9	444
		DISP. HOLD TIME		Set the stationary time in air .	0			0 - 31	445
		HOLD TIME IN LIQUID		Set the stationary time in liquid.	0			0 - 31	446
		OPE. STNBY TIME		Set the time for waiting the measurement start-up condition.	0			0 - 31	447
		OPE. STATUS		Status for density profile processing				0: ACCE TONG 1: STANDBY 2: IN OPERATION 3: END/NORMAL 4: END/ LIQ. UNSTABLE 5: END/ABNOMAL	450
		LEVEL CONDITION		Level condition				0: OFF LEVEL MEAS 1: STABLE 2: UNSTABLE 3: IGNORE CNDITION DD/HH/MM	451
		OPE. TIME		Normal closing time for density profile processing					452
DENSITY	DENSITY	AVERAGE DENSITY		Average density				453	
		AVERAGE TEMP.		Average temperature				454	
POSITION	POSITION	DENSITY No. 1-16		The measurement density of each point	0.0000 g/cm ³			460 - 475	
		POSITION No. 1-16		The density measurement position of each point	0.0mm			480 - 495	

Matrix group	Function group	Item	Access Code	Short description	Default value	Set Select Display	Possible settings, selections, or display	Matrix position [GVH]
I/F PROFILE	I/F PROFILE OPE.SYS	OPE. STATUS		Status for density profile processing			0: ACCEPTING 1: STANDBY 2: IN OPERATION 3: END/NORMAL 4: END/ LIQ. UNSTABLE 5: END/ ABNORMAL	550
		LEVEL CONDITION		Level condition			0: OFF LEVEL MEAS 1: STABLE 2: UNSTABLE 3: IGNORE CONDITION	551
			OPE. TIME		Normal closing time for density profile processing		DD/HH/MM	552
			I/F LEVEL		Interface level			553
			AVERAGE DENSITY		Average density			554
			AVERAGE TEMP		Average Temperature			555
	DENSITY		DENSITY No. 1-16		The measurement density of each point	0.0000 g/cm ³		560 - 575
	POSITION		POSITION No. 1-16		The density measurement position of each point	0.0mm		580 - 595

10 Appendix B

10.1 Specification for Arithmetic Calculations

10.1.1 Data Rounding

Set a method for processing the first decimal place of data.

10.1.1.1 Level Data Rounding [380] LEVEL DATA ROUND

This setting is reflected on :

[000] MEASURED LEVEL	[140] MANUAL LEVEL
[143] MANUAL WATER LEV.	[161] FLOAT ROOF LEVEL
[168] STRAP WATER LEVEL	[171] STRAPPING LEVEL

- When 10⁻¹mm DISCARD is selected, 10⁻¹mm is discarded
- When 10⁻¹mm ROUNDING is selected, 10⁻¹mm is rounded
- When NONE is selected, rounding is not executed.

10.1.1.2 Temperature Data Rounding [381] TEMP. DATA ROUND

This setting is reflected on [001] LIQUID TEMP. and [008] GAS TEMP.

- When ROUND 0.1 is selected, rounding is not executed.
- When ROUND 0.25 is selected, rounding is executed as follows.

0.0 to 0.1 °C	→	0.00 °C
0.2 to 0.3 °C	→	0.25 °C
0.4 to 0.6 °C	→	0.50 °C
0.7 to 0.8 °C	→	0.75 °C
0.9 to 1.0 °C	→	1.00 °C (carry)

- When ROUND 0.5 is selected, rounding is executed as follows.

0.0 to 0.2 °C	→	0.0 °C
0.3 to 0.7 °C	→	0.5 °C
0.8 to 1.0 °C	→	1.00 °C (carry)

10.1.2 Tank Selection and FRT/ ST Setting

10.1.2.1 Tank Type Selection [190] TANK TYPE

Select CRT if the tank is cone roof tank or dome roof tank.

Select FRT if the tank is floating roof or covered floating roof tank.

Select ST if the tank is spherical tank.

10.1.2.2 Setting Items for FRT

- [160] FLOAT ROOF LEVEL
Set the weight of the floating roof if gross volume or net volume needs to be calculated.
- [161] FLOAT ROOF LEVEL
Set floating roof point (FRP)
- [195] NET VOL. CALCULAT
Select equation for net volume calculation. Refer to " Net Volume Calculation".

10.1.2.3 Setting Items for ST

- [156] TANK CAPACITY
Set the tank valume. This value is used to calculate tank weight.

10.1.3 Manual Data Setting [140] - [147]

For each piece of level and temperature data, change from manual setting data to sensor data. If data cannot be collected, stay in manual setting data and set values that are reflected in arithmetic operations.

1.[140] MANUAL LEVEL

To get data from sensor, set "-1000", otherwise, set between 0-99999 (mm)

2.[141] MANUAL LIQ. TEMP.

To get data from sensor, set "-100", otherwise, set between -99.9 - +300.0 (°C)

3.[142] MANUAL DENSITY

To set density data manually, input the density data at 15°C and select NONE at [199] D15.CALC. TAB.

To use measured data from sensor, set "-1000". And at [199] D15.CALC.TAB, choose which table to use to convert the measured density data to data density at 15°C. Select the table among Table 53, 53A 53B, 53D.

Note!



Applicable range for Table 53 is 0.420 - 0.595.

4.[143] MANU. WATER LEV

To use measured data from sensor (data in [007] WATER LEVEL = upper interface level), set "-1", otherwise set between 0 - 99999 (mm).

5.[144] MANU GAS TEMP.

To use measured data from sensor (data in NMS mode 1 [211] DEVEICE (1)), set "-100", otherwise set between -99.9 - +300.0 (°C).

Note!



Measured gas temperature is available only when the sensor is NMS. And the device for gas temperature should be set as HART DEVICE 1.

6.[145] MANU GAS PRESS

To use measured data, from sensor (data in NMS mode 1 [312] DEVICE (2)), set "-1000", otherwise set between -999.999 - +99.999 (kg/cm²).

Note!



Measured gas pressure is available only when the sensor is NMS. And the device for gas pressure should be set as HART DEVICE 2.

7.[146] MANU. GAS DENS.

Set the gas density data. This data will be reflected in net weight calculation.

8.[147] WATER CONTENT

Set the water content (%) manually. This data will be reflected in gross volume, and net volume calculation.

10.1.4 Tank Table/Coefficient Setting [170] - [187]

10.1.4.1 Tank Table Setting for CRT or FRT

A Tank Table of up to 100 strapping points is allowed. Prepare the Tank Table and follow the steps below. "XXX" are the numbers you enter which are taken from "Tank Table Example".

Tank Table Example

Resource	Tank Table		Calculation Book
Table Pointer	Level (mm)	Volume (kl)	Volume per 1 mm (kl)
0	31	0.70304300	0.02418294
1	950	23.67683600	0.02439797
:	:	:	:

(↑ These columns are not shown in a Tank Table. ↑)

1.[170] TANK TABLE

Set the table pointer for 0.

2.[171] STRAPPING LEVEL

Set the LEVEL according to the tank strapping table. (31 in the example above)
(Begin with lowest point)

3.[172] STR. VOL. UP DGT. (strapping volume for the level — higher digits)

Set the volume for the registered level from tank strapping table (higher digits).
(0.703 (kl) in the example above)

4.[173] STR. VOL. LO DGT. (strapping volume for the level — lower digits)

Set the volume for the registered level from tank strapping table (lower digits).
((0.703) 04300 (kl) in the example above)

5.[174] NET AREA UP DGT. (net volume per 1 mm —higher digit)

Set the volume per 1mm in tank strapping table (higher digits).
(0.024(kl) in the example above)

6.[175] NET AREA LO DGT. (net volume per 1 mm — lower digits)

Set the volume per 1mm in tank strapping table (lower digits).
((0.024)182974(kl) in the example above)

7.[158] VOLUME CORRECTIO(volume correction)

Set a certain value to add or subtract from gross volume after it is calculated

8.[159] DENSITY CALIBR. (density calibration)

Set the value if the tank strapping table includes this description.

9.1.4.2 Tank Coefficient Setting for ST

The tank coefficient can be divided into 8 points for registration.

1. [170] TANK TABLE

Set the table pointer for 0. up to 8 (0 - 7) can be set.

2. [171] STRAPPING LEVEL

Set the LEVEL according to the tank table.
(Set the level from lower level to higher level)

3. [180] ST CONSTANT P1, [181 ST CONSTANT] P2

Set constant for the level from the tank table.
e.g. +/-X.XXXXXYYYY set Xs in [180], Ys in [181]

- 4.[182] ST CONSTANT Qn1, [183] ST CONSTANT Qn2
Set constant Q for the level from the tank table.
e.g. +/-XXX.XXXYYYYY set Xs in [182], Ys in [183]
5. [184] ST CONSTANT Rn1, [185] ST CONSTANT Rn2
Set constant S for the level from the tank table.
e.g. +/-XXXX.YYYYYY set Xs in [184], Ys in [185]
6. [186] ST CONSTANT Sn1, [187] ST CONSTANT Sn2
Set constant S for the level from the tank table.
e.g. +/-XXXXX.YYYYY set Xs in [186], Ys in [187]
7. Go back to [170] TANK TABLE and repeat for pointer 1,2,3,4....until TANK Table is complete.

10.1.5 Water Level Table Setting

Water Level Table can be set up to 30 points. prepare the tank table to start.

- 1.[167] WATER LEVEL TABL.
Set the table pointer for 0.
2. [168] STRAP WATER LEVEL
Set the LEVEL according to the tank table.
3. [169] STRAP WATER VOL.
Set the volume for the registered level.
4. [192] SUBTR. WATER LEV.
Select how water volume is subtracted.
When NONE is selected, water volume will not be subtracted.
When GROSS VOL. is selected, water volume will be subtracted from gross volume.
When NET VOL. is selected, water volume will be subtracted from net volume.

10.1.6 Water Volume Calculation in a CRT or FRT

Make sure that CRT or FRT is selected in [190] TANK TYPE
Comparison is carried out for each step (up to 30 points) using the water level measured by the transmitter (NMS) or the manually entered value and the water level table registered in the matrix.

$$VW = \frac{LW_x - LW_n}{LW_{n+1} - LW_n} (VW_{n+1} - VW_n) + VW_n \dots\dots\dots (1)$$

$$LW_1 \leq LW_n \leq LW_x \leq LW_{n+1} \leq LW_{30}$$

VW: Water volume to be determined
(VW = 0 when NONE is selected in [192]) SUBTR. WATER LEV.)

LW_x: Measured water level [007]

LW_n, LW_{n+1}: Water table level ([168] STRAP WATER LEVEL)

VW_n, VW_{n+1}: Strap water volume ([169] STRAP WATER VOL.)

When LW_x ≤ LW₁, VW = VW₁

When LW_x ≥ LW₃₀, VW = VW₃₀

10.1.7 Gross volume (VG) Calculation

First calculate temporary gross volume (Vt), then calculate gross volume(VG).
 The calculation of Vt varies depends on your tank type and setting in [191] GROSS VOL. CALCUL. and [195] NET VOL. CALCULAT.
 Look at the table below and choose Vt calculation type.

Vt calculation type	tank type	[191]	[195]
A	CRT	Method 1	
	FRT	Method 1	Method 1/2/3
B	CRT	Method 2	
	FRT	Method 2	Method 1/2/3
C	FRT	Method 1/2	Method 4
D	ST		

 Note!
 No matter what is selected for a blank space, calculation will work properly.

10.1.7.1 Temporary Gross Volume (Vt) Calculation

Vt Calculation Type A

Comparison is carried out for each step (up to 100 points) using the level measured by the transmitter (NMS) or the manually entered value and tha tank table registered in the matrix.

$$V_t = \frac{(L_x + LR) - L_n}{L_{n+1} - L_n} (V_{n+1} - V_n) + V_n + VR \dots\dots\dots (2)$$

$L_1 \leq L_n < L_x \leq L_{100}$
 L_x : [000] MEASURED LEVEL
 LR : TANK LEV. CORRECTION ([167] TANK LEV. CORRECT
 L_n, L_{n+1} : STRAPPING LEVEL ([171] STRAPPING LEVEL
 V_n, V_{n+1} : STR. VOL. (Sum of [172] UP DGT.)
 VR : VOLUME CORRECTION ([158]) VOL. CORRECTIO

Vt Calculation Type B

Comparison is carried out for each step (up to 100 point) using the level measured by the transmitter (NMS) or the manually entered value and tha tank table registered in the matrix.

$$V_t = V_n + (L_x - L_n) \Delta V_n + VR \dots\dots\dots (3)$$

$L_1 \leq L_n < L_x \leq L_{100}$
 V_n : STR. VOL. (Sum of [172] UP DGT. And [173] LO DGT.)
 L_x : [000] MEASURED LEVEL
 L_n : STRAPPING LEVEL ([171] STRAPPING LEVEL
 ΔV_n : Volume per 1 mm in the calculation book
 (Sum of [174] UP DGT. and [175]LO DGT.
 VR : VOLUME CORRECTION ([158]) VOL. CORRECTIO

Vt Calculation Type C

Comparison is carried out for each step (up to 100 point) using the level measured by the transmitter (NMS) or the manually entered value and the tank table registered in the matrix.

■ **When the Floating Roof is not floating (Lx < FRP)**

Lx : [000] MEASURED LEVEL

FRP : Floating Roof Point ([161] FLOAT ROOF LEVEL)

When [191] is set to METHOD 1, equation (2) is used to calculate Vt.

When [191] is set to METHOD 2, equation (3) is used to calculate Vt.

Volume caused of floating roof weight needs to be deducted from Vt.

$$V_t = V_t - \left(\frac{1}{V_{cf} \rho_{15}} - \frac{1}{BSG} \right) FRW \dots\dots\dots (4)$$

Vt' : Temporary gross volume to be determined
 Vt : if [191] METHOD 1 → Vt calculated by equation (2)
 : if [191] METHOD 2 → Vt calculated by equation (3)
 Vcf : Volume conversion factor
 (Refer to "Calculating Volume Conversion Factor")
 ρ15 : Reference Density at 15°C (g/cm³) ([006] REF. DENSITY)
 BSG : Calibration density ([159] DENSITY CALIBR.)
 FRW : Floating Roof Weight ([160] FLOAT ROOF WEIGH.)

Vt Calculation Type D

The following calculation is carried out using the level measured by the transmitter (NMS), or the manually entered value and the tank coefficient registered in the matrix. The tank coefficient can be divided into 8 points for registration. Register points in [170] TANK TABLE, levels in [171] STRAPPING LEVEL.

$$0 \leq L_x < L_1 \quad V_t = P \left(\frac{L_x + LR}{1000} \right)^3 + Q_1 \left(\frac{L_x + LR}{1000} \right)^2 + R_1 \left(\frac{L_x + LR}{1000} \right) + S_1 + \frac{VR}{1000}$$

$$0_1 \leq L_x < L_2 \quad V_t = P \left(\frac{L_x + LR}{1000} \right)^3 + Q_2 \left(\frac{L_x + LR}{1000} \right)^2 + R_2 \left(\frac{L_x + LR}{1000} \right) + S_2 + \frac{VR}{1000}$$

$$0_{n-1} \leq L_x < L_n \quad V_t = P \left(\frac{L_x + LR}{1000} \right)^3 + Q_n \left(\frac{L_x + LR}{1000} \right)^2 + R_n \left(\frac{L_x + LR}{1000} \right) + S_n + \frac{VR}{1000}$$

$$0_7 \leq L_x < L_8 \quad V_t = P \left(\frac{L_x + LR}{1000} \right)^3 + Q_8 \left(\frac{L_x + LR}{1000} \right)^2 + R_8 \left(\frac{L_x + LR}{1000} \right) + S_8 + \frac{VR}{1000} \dots\dots\dots (5)$$

Vt : Temporary gross volume — rounded to decimal place zero
 Lx : Measured Level [000] MEASURED LEVEL
 LR : Level Correction Value ([157] TANK LEV. CORRECT)
 L1 to L8 : Levels for pointers registered in [171] STRAPPING LEVEL
 P : Constant registered in [180] ST CONSTANT P1, [181] ST CONSTANT P2
 Q1 to Q8 : Constant registered in [182] ST CONSTANT Qn1, [183] ST CONSTANT Qn2
 R1 to R8 : Constant registered in [184] ST CONSTANT Rn1, [185] ST CONSTANT Rn2
 S1 to S8 : Constant registered in [186] ST CONSTANT Sn1, [187] ST CONSTANT Sn2
 VR : Volume correction value registered in [158] VOLUME CORRECTIO

10.1.7.2 Gross volume (VG) Calculation

$$VG = V_t - VW - V(BS / W) \dots\dots\dots (6)$$

VW : Water volume determined by Equation (1)
 (VW = 0 when NONE or NET VOL. is selected in [192]);
 Vt : Temporary gross volume determined by Equation (2)/(3)/(4)/ (5)
 V(BS/W) : Moisture Content (lit.) — Determined as follows

$$V(BS/W) = (V_t - VW) \frac{BS/W}{100}$$

(V(BS/W) = 0 when NONE or NET VOL. is selected in [193])
 BS/W: Moisture Content (%) manually entered [147] WATER CONTENT

10.1.8 Volume Conversion Factor (Vcf) Calculation

First, select equation for volume conversion factor in [194] NET VOL.CALC. TAB.
 Secondly, select the number of digits for VCF either X.XXXX or X.XXXXXX in [382] V.C.F.DIGIT.

Note!

 If a reference temperature for the net volume is other than 15°C, select TABLE6X and set a reference temperature in [162] VCF. REF. TEMP.

$$Vcf = \exp[-\alpha T \Delta t (1.0 + 0.8 \alpha T \Delta t)]$$

$$\alpha T = \frac{ (K_0 + K_1) \rho_{15}}{ (\rho_{15})^2} \quad \text{or} \quad \alpha T = A + \frac{B}{ (\rho_{15})^2} \dots\dots\dots (7)$$

αT : Thermal expansion coefficient at 15°C (1/°C)
 Δt : Temperature difference [$\Delta t = t - 15$](°C)
 t : Measured temperature (°C)
 K₀,K₁ : See the table below
 ρ_{15} : Reference Density at 15°C (g/cm³) registered in [006] REF/ DENSITY
 A,B : See the table below

ASTM D1250-1980	Liquid type	Density range (15°C)	K0	K1	A	B
TABLE 54A	Crude oil	0.6105-1.0750	613.9723	0.0		
TABLE 54B	Automobile gasoline	0.6530-0.7700	346.4228	0.4388	-	
	Fuel oil	0.7705-0.7875	-	-	-0.00336312	2680.3206
	Kerosene Industry gasoline Aircraft turbine fuel oil	0.7880-0.8385	594.5418	0.0	-	-
	Heavy oil, Light oil	0.8390-1.0750	186.9696	0.4862	-	-
TABLE 54D	Lubricating oil	0.8000-1.1640	0.0	0.6278		

10.1.8.1 ASTM D1250 TABLE 54

$$Vcf = 1 + Q_1 (t - 15) + Q_2 (t - 15)^2 \dots\dots\dots (8)$$

$$Q_1 = - \frac{P_1}{\rho 15} + P_2 \quad Q_2 = - \frac{P_3}{\rho 15} + P_4$$

For Constants P₁, P₂, P₃ and P₄, see Table below.

		P ₁ × 10 ⁻⁶	P ₂ × 10 ⁻⁶	P ₃ × 10 ⁻⁶	P ₄ × 10 ⁻⁶
1	0.500 ≤ ρ 15 < 0.570	4235.0	5362.8	23.436	38.105
2	0.570 ≤ ρ 15 < 0.585	3343.1	3845.6	1.492	1.786
3	0.585 ≤ ρ 15 < 0.600	3012.3	3280.0	1.492	1.785
4	0.600 ≤ ρ 15 < 0.620	2448.9	2340.9	1.589	1.947
5	0.620 ≤ ρ 15 < 0.640	2225.1	1980.0	1.588	1.946
6	0.640 ≤ ρ 15 < 0.660	1936.6	1529.1	1.588	1.946
7	0.660 ≤ ρ 15 < 0.680	1817.7	1348.9	1.588	1.945
8	0.680 ≤ ρ 15 < 0.700	1756.4	1258.7	1.588	1.945
9	0.700 ≤ ρ 15 < 0.750	1806.8	1330.8	1.588	1.945
10	0.750 ≤ ρ 15 < 0.770	2226.8	1889.8	1.588	1.946
12	0.790 ≤ ρ 15 < 0.810	1734.8	1258.7	1.588	1.945
13	0.810 ≤ ρ 15 < 0.830	1515.9	988.4	1.588	1.945
14	0.830 ≤ ρ 15 < 0.850	1291.7	718.1	1.587	1.945
15	0.850 ≤ ρ 15 < 0.875	1108.1	502.0	1.587	1.945
16	0.875 ≤ ρ 15 < 0.900	919.1	285.9	1.586	1.944
17	0.900 ≤ ρ 15 < 1.000	708.2	51.8	1.587	1.944
18	1.000 ≤ ρ 15 < 1.100	984.2	328.0	-7.481	-7.129
19	1.100 ≤ ρ 15 < 1.200	890.0	242.3	-7.830	-7.453

10.1.8.2 ASTM D1250 TABLE 55

0.9654 ≤ ρ 15 ≤ 1.0754	V c f = 0.965866 - 613 × 10 ⁻⁶ (t - t ₀) + 15 × 10 ⁻⁶ (t - t ₀) ²
0.8495 ≤ ρ 15 ≤ 0.9653	V c f = 1.01079 - 722 × 10 ⁻⁶ t + 20 × 10 ⁻⁶ t ²
0.7751 ≤ ρ 15 ≤ 0.8494	V c f = 1.01340 - 839 × 10 ⁻⁶ t + 4 × 10 ⁻⁶ t ²
0.7237 ≤ ρ 15 ≤ 0.7750	V c f = 1.01629 - 1084 × 10 ⁻⁶ t - 20 × 10 ⁻⁶ t ²
0.6722 ≤ ρ 15 ≤ 0.7236	V c f = 1.01899 - 1262 × 10 ⁻⁶ t + 28 × 10 ⁻⁶ t ²
0.6417 ≤ ρ 15 ≤ 0.6721	V c f = 1.02159 - 1434 × 10 ⁻⁶ t - 48 × 10 ⁻⁶ t ²
0.6275 ≤ ρ 15 ≤ 0.6416	V c f = 1.02266 - 1503 × 10 ⁻⁶ t - 55 × 10 ⁻⁶ t ²
0.6112 ≤ ρ 15 ≤ 0.6274	V c f = 1.02407 - 1595 × 10 ⁻⁶ t - 62 × 10 ⁻⁶ t ²

t₀ = 70.0°C

..... (9)

10.1.8.3 ASTM D1250 TABLE 6X

Set a reference temperature in [162] VCF REF. TEMP

$$Vcf = \frac{Vcf(t / 15)}{Vcf(tb / 15)} \dots\dots\dots (10)$$

Vcf(t/15) : Conversion factor determined from TABLE 54A and 54B at measured temperature t.

Vcf(tb/15) : Conversion factor determined from TABLE 54A and 54B at reference temperature tb.

tb : a reference temperature in [162].

10.1.8.4 ASTM D1555 TABLE 2

For temperature conversion, the system internally has ASTEM D1555 TABLE2 for BENZENE, TOLUENE, XYLENE, STYRENE, ORTHO XYLENE, META XYLENE, PARA XYLENE, CYCLO HEXANE, AROMATIC (300)(=300 to 350°F), and AROMATIC (350)(=350 to 450°F).

10.1.8.5 Method 1

Set a temperature conversion factor in [163] VCDF FOR CHEMICAL.

$$V_{cf} = 1 + (\rho_{15} - 1.0011) - (t - 20)\alpha \dots\dots\dots (12)$$

t : Measured Temperature [001]
 α: Temperature conversion factor in [163]
 ρ15: Reference Density at 15 °C (g/cm³) in [006] REF. DENSITY

10.1.8.6 Method 2

$$V_{cf} = 1 + (\rho_{15} - 1.0011) - (t - 20)\alpha \dots\dots\dots (12)$$

t : Measured Temperature [001]
 α: Temperature conversion factor in [163]
 ρ15: Reference Density at 15oC (g/cm3) in [006] REF. DENSITY

10.1.9 Tank Expansion Coefficient (Kt) Calculation

Set a tank expansion coefficient (1/°C) in [164] TANK EXPAN. COEFF.
 Set a tank expansion correction reference temperature in [165] EXPAN REF. TEMP.

$$K_t = 1 + \beta (t - t_a) \dots\dots\dots (13)$$

Kt : Tank expansion coefficient rounded to six decimal place
 β : Tank expansion coefficient (1/°C) in [164]
 t : Measured temperature (°C) [001] LIQUID TEMP.
 t_a : Tank expansion reference temperature (°C) in [165]

10.1.10 Net Volume (VN) Calculation

Then net volume is calculated as follows using gross volume, the volume conversion factor, and the tank expansion coefficient. Description of the terms are listed at the end of this section.

10.1.10.1 Calculating the Conversion Factor of a CRT

$$VN = (VG - VW) K_t V_{cf} \left(1 - \frac{BS}{100} \right) \dots\dots\dots (14)$$

10.1.10.2 Calculating the Conversion Factor of a CRT

■ **When the Floating Roof is not floating completely (L_x<FRP)**
 Same as Equation (14)

■ **When the Floating Roof is floating (L_x ≥ FRP)**
 When [195] NET VOL. CALCULAT is METHOD-1

$$VN = (VG - VW) K_t V_{cf} \left(1 - \frac{BS}{100} \right) - \frac{FRW}{\rho_{15}} \dots\dots\dots (15)$$

When [195] NET VOL. CALCULAT is METHOD-2

$$VN = \left[(VG - VW) K_t - \left(\frac{1}{Vcf \rho_{15}} - \frac{1}{BSG} \right) FRW \right] Vcf \left(1 - \frac{BS/W}{100} \right) \dots\dots\dots (16)$$

When [195] NET VOL. CALCULAT is METHOD-3

$$VN = (VG - VW) K_t Vcf \left(1 - \frac{BS/W}{100} \right) - \left(\frac{1}{\rho_{15}} - \frac{1}{BSG} \right) FRW \dots\dots\dots (17)$$

When [195] NET VOL. CALCULAT is METHOD-3
Same as Equation (14).

10.1.10.3 Calculating the Coersion Factor of a ST

Same as Equation (14)

Note!
No matter what is selected in [195] for CRT/ST, calculation will work properly.

List of terms

- VN : Net volume to be determined
- VG : Gross volume determined by Equation (6)
- VW : Water volume (lit.) determined by Equation (6)
(VW=0 when NONE GROSS VOL. is selected in [192])
- Kt : Tank expansion coefficient determined by equation (13)
- Vcf : Volume Conversion Factor (determined at sect. 4)
- BS/W : Water content (%) manually entered in [147]
(BS/W=0 when NONE or GROSS VOL. is selected in [193])
- FRW : Floating Roof Weight [160]
- ρ15 : Reference Density at 150°C (g/cm³) registered in REF. DENSITY [006]
- BSG : Test density (registered in DENSITY CALIBR. [159])

10.1.11 Net Weight (WN) Calculation

The following calculations are based on the setting in [196] MASS CALCULATION.

10.1.11.1 When [196] MASS CALCULATION is NONE

$$WN = 0$$

10.1.11.2 When [196] MASS CALCULATION is METHOD-1

$$WN = VN \rho_{15} \dots\dots\dots (18)$$

VN : Net volume determined by Equations (14)/(15)/(16)/(17)
ρ15 : Reference Density at 15°C (g/cm³) ([006] REF. DENSITY)

10.1.11.3 When [196] MASS CALCULATION is METHOD-2

$$WN = VN(\rho_{15} - 0.0011) \dots\dots\dots (19)$$

VN : Net volume determined by Equations (14)/(15)/(16)/(17)
 ρ15 : Reference Density at 15°C (g/cm³) ([006] REF. DENSITY)

10.1.11.4 When [196] MASS CALCULATION is METHOD-3

$$WN = WI + Wg \dots\dots\dots (20)$$

WN : Weight of the liquid layer
 WI : Weight of the gas portion

$$WI = VN \rho_{15}$$

VN : Net volume determined by Equations (14)/(15)/(16)/(17)
 ρ15 : Reference Density at 15 °C (g/cm³) [006] REF. DENSITY

$$Wg = (VMAX - VG) Dg \frac{(1 + P)}{1} \left(\frac{273}{273 + tg} \right) \frac{1}{1000}$$

VMAX : Total tank volume set in [156] TANK CAPACITY
 (Set the total volume of the tank in [156])
 VG : Gross Volume determined by equation (6)
 Dg : Gas density set in [146] MANUAL GAS DENSITY
 P : Gas pressure in [009] GAS PRESSURE
 tg : Gas temperature in [008] GAS TEMPERATURE

10.1.11.5 When [196] MASS CALCULATION is METHOD-4

$$WN = WI + Wg \dots\dots\dots (21)$$

WN : Weight of the liquid layer
 WI : Weight of the gas portion

$$WI = VN(\rho_{15} - 0.0011)$$

VN : Net volume determined by Equations (14)/(15)/(16)/(17)
 ρ15 : Reference Density at 15 °C (g/cm³) ([006] REF. DENSITY)

$$Wg = (VMAX - VG) \left(\frac{273}{273 + tg} \right) \frac{(1.033 + P)}{1.033} \frac{M}{22.4} \frac{1}{\rho_{15}} (\rho_{15} - 0.0011) \frac{1}{1000}$$

VMAX : Total tank volume set in [156] TANK CAPACITY
 (Set the total volume of the tank in [156])
 VG : Gross Volume determined by equation (6)
 tg : Gas temperature in [008] GAS TEMPERATURE
 P : Gas pressure in [009] GAS PRESSURE
 M : MOL weight set in [166] MOL WEIGHT

11 Appendix C

11.1 Specifications for Host Communication

11.1.1 Transmission Specification

Physical layer		EIA RS232C
Synchronization method		Start-stop synchronization(asynchronous)
		No procedure
Communication procedure		Bi-directional half-duplex communication
Connection		Point to point
Transmission speed		2400; 4800; 9600; 19200BPS (set by user)
Frame	Start bit	1 start bit
	Data	7 bits; 8 bits
	Parity	Even number; odd number; none (set by user)
	Spot bit	1 stop bit; 2 stop bits (set by user)
Mode	NRM571 side	DTE mode
	Host side	DCE mode

Connection cable

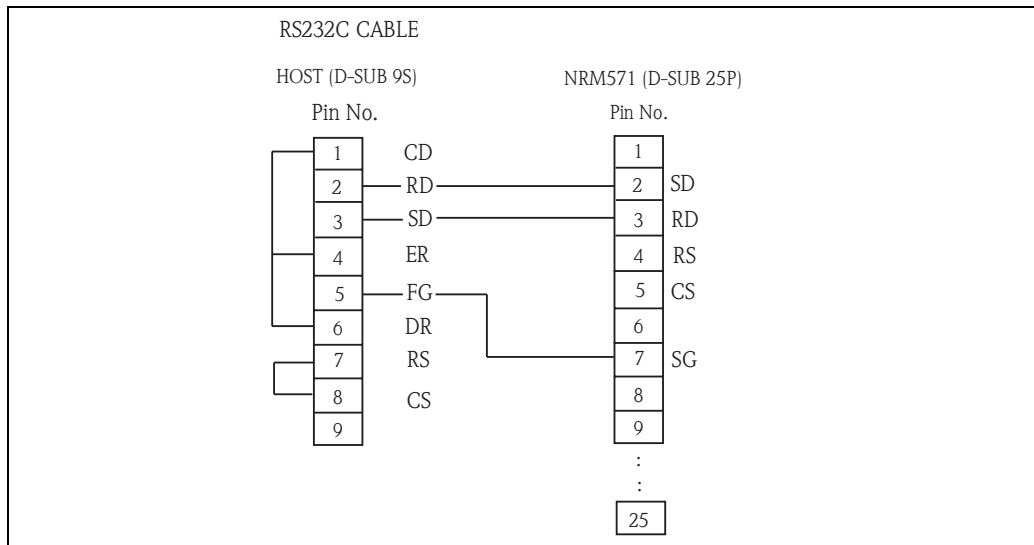

11.1.2 Communication Protocol

In NRM, a communication method is selected from the following four types depending on the communication protocol registered in [350] COMMUNICATION. With all four, the host operates as a master, while NRM operates as a slave. NRM replies only when issued a request by the host. (NRM cannot initiate a request).

Communication port 1 (for host)

Protocol	Detail
MDP	Conform to communication specifications between the I/F section using our MDP-II receiver.
BBB	Conform to host communication specifications for our BBB receiver.

Protocol	Detail
MODBUS	RTU mode (Refer to "MODBUS protocol")

Communication port 2 (for maintenance)

Protocol	Detail
Softwear for maintenace (ToF Tool)	Connecting port

11.1.3 Protocols

10.2.3.1 MDP Protocols

■ Request message

The host issues a request message.

The message consists of text with a fixed length of 96 bytes.

Request message (host - NRM)

Rank	Signal name	Code	Contents
1	STX	02h	Start code
2	Request No. 10 ²	30h to 39h	001 - 002
3	Request No. 10 ¹	30h to 39h	
4	Request No. 10 ⁰	30h to 39h	
5	Level gauge operation		U: Lift; I: Measurement; G: Density B: Interface; D:Bottom surface
6	Stop	53h or 40h	S: Stop; @: Normal
7	(Return)	40h	@: Nomal (R: Return...for future implemenation)
8	Reserved	40h	
9	Reserved	40h	
10	Reserved	40h	
↓	↓		
92			
93	Reserved	40h	
94	ETX	03h	Terminal code
95	CR	0dh	Terminal code
96	LF	0ah	Terminal code

■ Reply message

NRM replies.

A reply message consists of text with a fixed length of 96 bytes.

After error occurs, indicated by [023] V1 COMM. ERR (error information) and [026] SENSOR ERROR (sensor error information) and TR-1 to 8 in ranks 22 to 29 are output.

Rank	Signal name	Code	Contents
1	STX	02h	Start code
2	Request No. 10 ²	30h to 39h	001 - 002
3	Request No. 10 ¹	30h to 39h	001 - 002
4	Request No. 10 ⁰	30h to 39h	001 - 002
5	Level 10 ⁴	30h to 39h	0 - 99999 mm
6	Level 10 ³	30h to 39h	
7	Level 10 ²	30h to 39h	
8	Level 10 ¹	30h to 39h	
9	Level 10 ⁰	30h to 39h	
10	Liquid temperature ±	2bh or 2dh	2bh: + 2dh: -
11	10 ²	30h to 39h	-50.0 - 300°C
12	10 ¹	30h to 39h	
13	10 ⁰	30h to 39h	
14	.	2eh	
15	10 ⁻¹	30h to 39h	
16	Gas pressure 10 ¹	30h to 39h	
17	10 ⁰	30h to 39h	
18	.	2eh	
19	10 ⁻¹	30h to 39h	
20	10 ⁻²	30h to 39h	
21	Reserved	40h	
22	Error TR-1	40h or 31h	40h: None 31h: TR-1
23	Error TR-2	40h or 32h	40h: None 32h: TR-2
24	Error TR-3	40h or 33h	40h: None 33h: TR-3
25	Error TR-4	40h or 34h	40h: None 34h: TR-4
26	Error TR-5	40h or 35h	40h: None 35h: TR-5
27	Error TR-6	40h or 36h	40h: None 36h: TR-6
28	Error TR-7	40h or 37h	40h: None 37h: TR-7
29	Error TR-8	40h or 38h	40h: None 38h: TR-8
30	Alarm THA	40h or 48h	40h: None 48h(H):ON Transmitter-set alarm
31	Alarm TLA	40h or 4ch	40h: None 4ch(C): ON
32	Status 1	40h or 31h	40h: None 31h: ST-1 ON
33	Status 2	40h or 32h	40h: None 32h: ST-2 ON
34	Status 3	40h or 33h	40h: None 33h: ST-3 ON
35	Status 4	40h or 34h	40h: None 34h: ST-4 ON
36	Level gauge condition 1		U: Lift; I: Measurement; G: Density; B: Interface; D: Bottom surface
37	2	53h or 40h	S: Stop; @: Normal
38	3	52h or 40h	R: Return; @: Normal
39	Reserved	40h	
40	Reserved	40h	
41	Reserved	40h	
42	Reserved	40h	
43	Reserved	40h	
44	Reserved	40h	
45	Reserved	40h	
46	Reserved	40h	
47	Reserved	40h	
48	Reserved	40h	
49	Reserved	40h	
50	Reserved	40h	
51	Reserved	40h	
52	Reserved	40h	

Rank	Signal name	Code	Contents
53	Reserved	40h	
54	Reserved	40h	
55	Reserved	40h	
56	Reserved	40h	
57	Reserved	40h	
58	Reserved	40h	
59	Reserved	40h	
60	Reserved	40h	
61	Gas temperature \pm	2bh or 2dh	2bh: + 2dh: -
62	10^2	30h to 39h	
63	10^1	30h to 39h	
64	10^0	30h to 39h	
65		2eh	
66	10^{-1}	30h to 39h	
67	Density 10^0	30h to 39h	
68		2eh	
69	10^{-1}	30h to 39h	
70	10^{-2}	30h to 39h	
71	10^{-3}	30h to 39h	
72	10^{-4}	30h to 39h	
73	Interface 10^4	30h to 39h	
74	10^3	30h to 39h	
75	10^2	30h to 39h	
76	10^1	30h to 39h	
77	10^0	30h to 39h	
78	Bottom surface 10^3	30h to 39h	
79	10^2	30h to 39h	
80	10^1	30h to 39h	
81	10^0	30h to 39h	
82	Reserved	40h	
83	Reserved	40h	
84	Reserved	40h	
85	Reserved	40h	
86	Reserved	40h	
87	Reserved	40h	
88	Reserved	40h	
89	Reserved	40h	
90	Reserved	40h	
91	Reserved	40h	
92	Reserved	40h	
93	Reserved	40h	
94	ETX	03h	Terminal code
95	CR	0dh	Terminal code
96	LF	0ah	Terminal code

10.2.3.2 BBB Protocol

■ Request message (host to NRM)

The message consists of text with a fixed length of 10 bytes.

When operating the tank gauge, select "0: No operation instruction" for communication type in rank 2 and set corresponded operation instructions.

Request message (host - NRM)

Rank	Signal name	Code	Contents
1	STX	02h	Start code
2	Communication type	30h to 31h	0: Only operation instructions 1: Tank data request
3	Request No. 10 ¹	30h to 39h	01 - 40
4	Request No. 10 ⁰	30h to 39h	
5	Operation code (*)	(*)	
6	Reserved	30h	S: Stop; @: Normal
7	Reserved	30h	
8	Reserved	30h	
9	CR	0dh	Terminal code
10	LF	0ah	Terminal code

(*) 30h : No operation instructions ; 32h: Lift level gauge
33h : Level gauge measurement ; 34h: Stop level gauge ; 36h: Return

■ **Request message (host to NRM)**

A reply message consists of text with a fixed length of 29 bytes.

Reply message (NRM - host)

Rank	Signal name	Code	Contents
1	STX	02h	Start code
2	Communication type	30h to 31h	0: Only operation instructions 1: Tank data request
3	Request No. 10 ¹	30h to 39h	01 - 40
4	Request No. 10 ⁰	30h to 39h	
5	Error	30h or 31h	S: Stop; @: Normal
6	Level 10 ⁴	30h to 39h	0 to 99999 mm
7	10 ³	30h to 39h	
8	10 ²	30h to 39h	
9	10 ¹	30h to 39h	
10	10 ⁰	30h to 39h	
11	Liquid temperature ±	2bh or 2dh	2bh: + ; 2dh: -
12	10 ²	30h to 39h	-50.0 to 300 °C
13	10 ¹	30h to 39h	
14	10 ⁰	30h to 39h	
15	10 ⁻¹	30h to 39h	
16	Alarm	See column at right	30h: No alarm; 4ch: Lower limit alarm; 48: Upper limit alarm
17	Operation instruction in response	See column at right	Returns (*) above
18	Status 1	30h or 31h	30h: off 31h: on
19	Status 2	30h to 31h	30h: off 31h: on
20	Status 3	30h to 31h	30h: off 31h: on
21	Status 4	30h to 31h	30h: off 31h: on
22	Status 5	30h to 31h	30h: off 31h: on
23	Status 6	30h to 31h	30h: off 31h: on
24	Status 7	30h to 31h	30h: off 31h: on
25	Status 8	30h to 31h	30h: off 31h: on
26	Reserved	30h	
27	Reserved	30h	
28	CR	0dh	Terminal code
29	LF	0ah	Terminal code

10.2.3.3 MODBUS RTU Protocol

In MODBUS protocol in NRM571, it is possible to select following address maps.

- Address map (NRM) : NRM Standard data map
- Address map (FLOAT1): IEEE, FLOAT data (32 bits)
- Address map (FLOAT2): IEEE, FLOAT data (32 bits)
- Address map (MDP): compatibility data map for MDP receiver
- Address map (DENSITY): density profile data map

■ Mode

NRM supports RTU slave mode only.

■ Message configuration

Each message is delivered and transmitted in the following sequence.

SLAVE ADDRESS	FUNCTION CODE	DATA	ERROR CHECK CRC
8 bits	8 bits	N x 8 bits	16 bits

■ Slave address

1 to 247

■ Function code

03/04: data read

maximum number of request data capacity per 1 frame (Maximum registers and Coil block pre-request)

- Address map (NRM) : 25 datas
- Address map (FLOAT1): 22 datas
- Address map (FLOAT2): 40 datas
- Address map (MDP): 16 datas
- Address map (DENSITY): 105 datas

06/16: data write

■ Error processing

NRM executes the following processing if an error occurs in the transmitted text

1. NRM makes no reply if the following errors are detected.

- Parity error
- Framing error
- Overrun error
- CRC error
- Incorrect slave address requested (outside range of 1 to 247)

2. NRM returns the following error message if an error occurs in the contents of the request message.

ADDRESS	FUNCTION CODE	ERROR CODE	CRC
8 bits	8 bits	* 1	16 bits

*1: Error code

- 01: Incorrect function code (except 03, 04, 06, 16)
- 02: Incorrect start address specified
- 03: Incorrect request register number requested (data number for MODBUS address map)

■ MODBUS Address list

Please refer to "MODBUS MAP"

■ Description of each item

1. LEVEL

Data is sent in unit "mm"

Data sent to host is not affected by setting of rounding [380] in NRM.

2. TEMP

Data is sent in unit "°C".
 Multiple by 10^{-1} after converted to decimal data because the data is sent up to 1 decimal point.
 Data sent to host is not affected by the setting of rounding [381] in NRM.

3. GROSS VOLUME, NET VOLUME

Data is sent in unit "liter".



Note!

Data is divided up the address into two parts and is sent. Please refer to "MODBUS Address map" about the data placement.

4. MASS

Data is sent in unit "kg".



Note!

Data is divided up the address into two parts and is sent. Please refer to "MODBUS Address map" about the data placement.

5. REF. DENSITY

Multiple by 10^{-3} after converted to decimal data because the data is sent up to 3 decimal points.

6. STATUS DATA (data of equipment connected to Tank gauge or Level transmitter)

Status	1	30h or 31h	30h: off	31h: on	STATUS DATA 1
Status	2	30h to 31h	30h: off	31h: on	
Status	3	30h to 31h	30h: off	31h: on	
Status	4	30h to 31h	30h: off	31h: on	
Status	5	30h to 31h	30h: off	31h: on	STATUS DATA 2
Status	6	30h to 31h	30h: off	31h: on	
Status	7	30h to 31h	30h: off	31h: on	
Status	8	30h to 31h	30h: off	31h: on	

	STATUS DATA 1					STATUS DATA 2			
	0	0	0	0		0	0	0	0
Bit	4	3	2	1		4	3	2	1

7. SENSOR ALARM

Host can receive the transmitter alarms set in sensor up to 2 points (alarm H and L).

Data (Hex)	Alarm H	Alarm L
0000	OFF	OFF
0001	ON	ON
0002	OFF	OFF
0003	ON	ON

8. SENSOR ERROR

When an error occurred in sensor, error code is sent in this address.
 Data is sent in hexadecimal number.
 Please refer to "Errors" for definition of the codes.

9. NRM ALARM

Alarm up to 8 points set in NRM is sent to host.
 NRM Alarm (0 - 255)
 eg. When 1, 7 or 8 point alarm occurred in NRM, [(193) 1100 0001] is sent.
 Please refer to "Alarm Processing" for alarm setting.

10. COMMU ERROR

Sensor communication error is sent to host.
 Please refer to "Errors" for definition of error code.

11. GAUGE STATUS

Gauge Operation status is sent to host.
Data in NRM [013] GAUGE STATUS is sent.

12. BALANCE STATUS

Data shows Sensor Balance status.
0000: UNBALANCE
0001: BALANCE

13. WATER LEVEL

Upper interface level
Data is sent in unit "mm"

14. GAS TEMP.

Data entered manually [008] or actual data from sensor is sent to host.
Multiple by 10^{-1} after converted to decimal data because the data is sent up to 1 decimal points.

15. GAS PRESSURE

Data entered manually [009] or actual data from sensor is sent to host.
Multiple by 10^{-1} after converted to decimal data because the data is sent up to 1 decimal points.

16. MID INTERF. LEVEL

Middle interface level
Data is sent in unit "mm"

17. MIDDLE DENSITY

Multiple by 10^{-3} after converted to decimal data because the data is sent up to 3 decimal points.

18. BOTTOM DENSITY

Multiple by 10^{-3} after converted to decimal data because the data is sent up to 3 decimal points.

19. GAUGE OPERATION

Gauge operation command data is written from host side.

20. RESERVED

Addresses that are not currently used.

Note!

When selecting MODBUS Address map (FLOAT 1) or (FLOAT 2), data is sent by IEEE 32Bit FLOAT type.

■ **Communication status**

1. Communication time

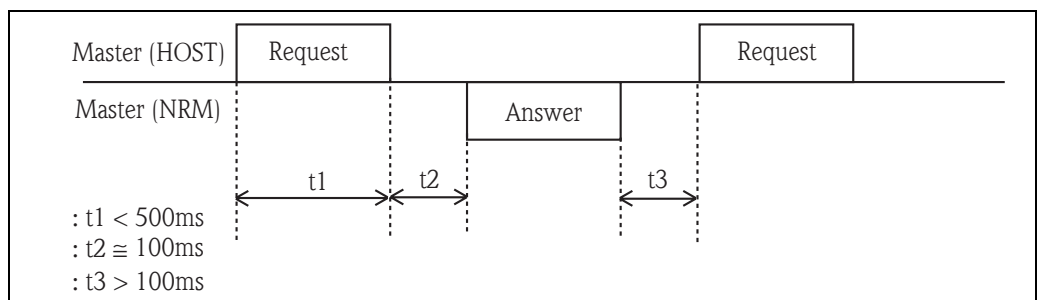

Note!

Communication error may occur depend on communication cable characteristic (cable type, number of sensors, cable distance etc.).

2. Please implement the error processing with certainly following condition in host side to avoid communication errors.

- Retry times : Minimum 5 times
- Retry interval : Minimum 1000 ms

3. Operation command

Writing command for gauge operation must sent with one shot.

MODBUS address map (NRM)

Address	Page	Function Code	Item	Transfer Range	Unit	Note
40001	0	03/04	Level	0 to 65535	mm	
40002	0	03/04	Temp.	-99.9 to 360.0	C	* 10 ⁻¹
40003	0	03/04	Gross Volume (L)	0 to 99999	L	
40004	0	03/04	Gross Volume (H)	0 to 32767	L	
40005	0	03/04	Net Volume (L)	0 to 99999	L	
40006	0	03/04	Net Volume (H)	0 to 32767	L	
40007	0	03/04	MASS (L)	0 to 99999	Kg	
40008	0	03/04	MASS (H)	0 to 32767	Kg	
40009	0	03/04	REF.Density	0 to 3.2767	g/Cm ³	* 10 ⁻⁴
40010	0	03/04	Status Data 1	0 to 1111		
40011	0	03/04	Status Data 2	0 to 1111		
40012	0	03/04	Sensor Alarm	0 to 4		
40013	0	03/04	Sensor Error	0 to 999		
40014	0	03/04	NRM Alarm	0 to 4		
40015	0	03/04	Communication Err.	0 to 999		
40016	0	03/04	Gauge Status	0 to F		
40017	0	03/04	Balance Status	0 to 1		
40018	0	03/04	Water Level	0 to 32767	mm	
40019	0	03/04	Gas Temp.	-99.9 to 300.0	C	* 10 ⁻¹
40020	0	03/04	Gas Pressure	0 to 3.2767	kg/Cm ²	* 10 ⁻⁴
40021	0	03/04	Mid. Interface Level	0 to 32767	mm	
40022	0	03/04	Mid. Density	0 to 3.2767	g/Cm ³	* 10 ⁻⁴
40023	0	03/04	Bottom Density	0 to 3.2767	g/Cm ³	* 10 ⁻⁴
40024	0	06/16	Gauge Operation	0 to 10		Write Data
40025	0	16	Density Meas. Select	0 to 4		Write Data
40026	0	16	MEAS.POINT SELECT	2 to 16		Write Data
40027	0	16	I/F MANUAL LEVEL	0 to 65535	mm	Write Data
			Density Profile datas			
40028	0	03/04	Operation Status	0 to 5		
40029	0	03/04	Level Condition	0 to 3		
40030	0	03/04	Operation Time(DAY)	01 to 31		
40031	0	03/04	Operation Time(HOUR)	00 to 24		
40032	0	03/04	Operation Time(MIN.)	00 to 59		
40033	0	03/04	Average Density	0 to 3.2767	kg/Cm ²	* 10 ⁻⁴
40034	0	03/04	Average Temp.	-99.9 to 300.0	C	* 10 ⁻¹
40035	0	03/04	Mesured Density 01	0 to 3.2767	kg/Cm ²	* 10 ⁻⁴
40036	0	03/04	Mesured Density 02	0 to 3.2767	kg/Cm ²	* 10 ⁻⁴
40037	0	03/04	Mesured Density 03	0 to 3.2767	kg/Cm ²	* 10 ⁻⁴
40038	0	03/04	Mesured Density 04	0 to 3.2767	kg/Cm ²	* 10 ⁻⁴
40039	0	03/04	Mesured Density 05	0 to 3.2767	kg/Cm ²	* 10 ⁻⁴
40040	0	03/04	Mesured Density 06	0 to 3.2767	kg/Cm ²	* 10 ⁻⁴

NRM HOST Communication MODBUS address map (FLOAT 1)

Address	Page	Function Code	Item	Transfer Range	Unit	Note
40001	0	03/04	Level	IEEE FLOAT DATA	mm	
40002	0	03/04	Temp.		C	
40003	0	03/04	Gross Volume		L	
40004	0	03/04	Net Volume		L	
40005	0	03/04	MASS		Kg	
40006	0	03/04	REF.Density		g/Cm ³	
40007	0	03/04	Status Data 1			
40008	0	03/04	Status Data 2			
40009	0	03/04	Sensor Alarm			
40010	0	03/04	Sensor Error			
40011	0	03/04	NRM Alarm			
40012	0	03/04	Communication Err.			
40013	0	03/04	Gauge Status			
40014	0	03/04	Balance Status			
40015	0	03/04	Water Level		mm	
40016	0	03/04	Gas Temp.		C	
40017	0	03/04	Gas Pressure		kg/Cm ²	
40018	0	03/04	Mid. Interface Level		mm	
40019	0	03/04	Mid. Density		g/Cm ³	
40020	0	03/04	Bottom Density		g/Cm ³	
40021	0	06/16	Gauge Operation	(0 to 10)		Write Data
40022	0	—	SPARE			
40023	1					
:	:					
:	:					
40045	1					
:	:					
:	:					
40859	39					
:	:					
:	:					
40880	39					

NRM HOST Communication MODBUS address map (FLOAT 2)

Address	Page	Function Code	Item	Transfer Range	Unit	Note
40001	0	03/04	Level	IEEE FLOAT DATA	mm	
40002	0	03/04	Temp.		C	
40003	0	03/04	Gross Volume		L	
40004	0	03/04	Net Volume		L	
40005	0	03/04	MASS		Kg	
40006	0	03/04	REF.Density		g/Cm ³	
40007	0	03/04	Status Data 1			
40008	0	03/04	Status Data 2			
40009	0	03/04	Sensor Alarm			
40010	0	03/04	Sensor Error			
40011	0	03/04	NRM Alarm			
40012	0	03/04	Communication Err.			
40013	0	03/04	Gauge Status			
40014	0	03/04	Balance Status			
40015	0	03/04	Water Level		mm	
40016	0	03/04	Gas Temp.		C	
40017	0	03/04	Gas Pressure		kg/Cm ²	
40018	0	03/04	Mid. Interface Level		mm	
40019	0	03/04	Mid. Density		g/Cm ³	
40020	0	03/04	Bottom Density		g/Cm ³	
40021	0	06/16	Gauge Operation	(0 to 10)		Write Data
40022	0	—	SPARE			

Address	Page	Function Code	Item	Transfer Range	Unit	Note
40001	0	03/04	Level	IEEE FLOAT DATA	mm	
40002	1	03/04	Level		mm	
40003	2	03/04	Level		mm	
40004	3	03/04	Level		mm	
40005	4	03/04	Level		mm	
40006	5	03/04	Level		mm	
40007	6	03/04	Level		mm	
40008	7	03/04	Level		mm	
40009	8	03/04	Level		mm	
40010	9	03/04	Level		mm	
40011	10	03/04	Level		mm	
40012	11	03/04	Level		mm	
40013	12	03/04	Level		mm	
40014	13	03/04	Level		mm	
40015	14	03/04	Level		mm	
40016	15	03/04	Level		mm	
40017	16	03/04	Level		mm	
40018	17	03/04	Level		mm	
40019	18	03/04	Level		mm	
40020	19	03/04	Level		mm	
40021	20	03/04	Level		mm	
40022	21	03/04	Level		mm	
40023	22	03/04	Level		mm	
40024	23	03/04	Level		mm	
40025	24	03/04	Level		mm	
40026	25	03/04	Level		mm	
40027	26	03/04	Level		mm	
40028	27	03/04	Level		mm	
40029	28	03/04	Level		mm	
40030	29	03/04	Level		mm	
40031	30	03/04	Level		mm	
40032	31	03/04	Level		mm	
40033	32	03/04	Level		mm	
40034	33	03/04	Level		mm	
40035	34	03/04	Level		mm	
40036	35	03/04	Level		mm	
40037	36	03/04	Level		mm	
40038	37	03/04	Level		mm	
40039	38	03/04	Level		mm	
40040	39	03/04	Level		mm	

Address	Page	Function Code	Item	Transfer Range	Unit	Note
40041	0	03/04	Temp.		C	
:	:	:	:	:	:	
40080	39	03/04	Temp.		C	
40081	0	03/04	Gross Volume		L	
:	:	:	:	:	:	
40120	39	03/04	Gross Volume		L	
40121	0	03/04	Net Volume		L	
:	:	:	:	:	:	
40160	39	03/04	Net Volume		L	
40161	0	03/04	MASS		Kg	
:	:	:	:	:	:	
40200	39	03/04	MASS		Kg	
40201	0	03/04	REF.Density		g/Cm3	
:	:	:	:	:	:	
40240	39	03/04	REF.Density		g/Cm3	
40241	0	03/04	Status Data 1			
:	:	:	:	:	:	
40280	39	03/04	Status Data 1			
40281	0	03/04	Status Data 2			
:	:	:	:	:	:	
40320	39	03/04	Status Data 2			
40321	0	03/04	Sensor Alarm			
:	:	:	:	:	:	
40360	39	03/04	Sensor Alarm			
40361	0	03/04	Sensor Error			
:	:	:	:	:	:	
40400	39	03/04	Sensor Error			
40401	0	03/04	NRM Alarm			
:	:	:	:	:	:	
40440	39	03/04	NRM Alarm			
40441	0	03/04	Communication Err.			
:	:	:	:	:	:	
40480	39	03/04	Communication Err.			
40481	0	03/04	Gauge Status			
:	:	:	:	:	:	
40520	39	03/04	Gauge Status			

Address	Page	Function	Item	Transfer Range	Unit	Note
40521	0	03/04	Balance Status			
:	:	:	:	:	:	
40560	39	03/04	Balance Status			
40561	0	03/04	Water Level		mm	
:	:	:	:	:	:	
40600	39	03/04	Water Level		mm	
40601	0	03/04	Gas Temp.		C	
:	:	:	:	:	:	
40640	39	03/04	Gas Temp.		C	
40641	0	03/04	Gas Pressure		kg/Cm ²	
:	:	:	:	:	:	
40680	39	03/04	Gas Pressure		kg/Cm ²	
40681	0	03/04	Mid. Interface Level		mm	
:	:	:	:	:	:	
40720	39	03/04	Mid. Interface Level		mm	
40721	0	03/04	Mid. Density		g/Cm ³	
:	:	:	:	:	:	
40760	39	03/04	Mid. Density		g/Cm ³	
40761	0	03/04	Bottom Density		g/Cm ³	
:	:	:	:	:	:	
40800	39	03/04	Bottom Density		g/Cm ³	
40801	0	16	Gauge Operation	(0 to 10)		Write Data
:	:	:	:	:	:	Write Data
40840	39	16	Gauge Operation	(0 to 10)		Write Data

MNRM HOST Communication MODBUS address map (MDP)

Address	Page	Function Code	Item	Transfer Range	Unit	Note
40001	0	03/04	Page No.	0 to 39		
40002	0	03/04	Level	0 to 65535	mm	
40003	0	03/04	Temp.	-99.9 to 360.0	C	* 10 ⁻¹
40004	0	03/04	Water Level	0 to 32767	L	
40005	0	03/04	Gross Volume (L)	0 to 99999	L	
40006	0	03/04	Gross Volume (H)	0 to 32767	L	
40007	0	03/04	Net Volume (L)	0 to 99999	L	
40008	0	03/04	Net Volume (H)	0 to 32767	L	
40009	0	03/04	MASS (L)	0 to 99999	Kg	
40010	0	03/04	MASS (H)	0 to 32767	Kg	
40011	0	03/04	REF.Density	0 to 3.2767	g/Cm ³	* 10 ⁻⁴
40012	0	03/04	Gas Temp.	-99.9 to 300.0	C	* 10 ⁻¹
40013	0	03/04	Gas Pressure	0 to 3.2767	kg/Cm ²	* 10 ⁻⁴
40014	0	—	SPARE			
40015	0	—	SPARE			
40016	0	—	SPARE			
40017	1					
:	:					
40032	1					
40625	39					
:	:					
40640	39					

MNRM HOST Communication MODBUS address map (Density Profile)

Address	Page	Function Code	Item	Transfer Range	Unit	Note
40001	0	03/04	Level	0 to 65535	mm	
40002	0	03/04	Temp.	-99.9 to 360.0	C	* 10 ⁻¹
40003	0	03/04	Gross Volume (L)	0 to 99999	L	
40004	0	03/04	Gross Volume (H)	0 to 32767	L	
40005	0	03/04	Net Volume (L)	0 to 99999	L	
40006	0	03/04	Net Volume (H)	0 to 32767	L	
40007	0	03/04	MASS (L)	0 to 99999	Kg	
40008	0	03/04	MASS (H)	0 to 32767	Kg	
40009	0	03/04	REF.Density	0 to 3.2767	g/Cm ³	* 10 ⁻⁴
40010	0	03/04	Status Data 1	0 to 1111		
40011	0	03/04	Status Data 2	0 to 1111		
40012	0	03/04	Sensor Alarm	0 to 4		
40013	0	03/04	Sensor Error	0 to 999		
40014	0	03/04	NRM Alarm	0 to 4		
40015	0	03/04	Communication Err.	0 to 999		
40016	0	03/04	Gauge Status	0 to F		
40017	0	03/04	Balance Status	0 to 1		
40018	0	03/04	Water Level	0 to 32767	mm	
40019	0	03/04	Gas Temp.	-99.9 to 300.0	C	* 10 ⁻¹
40020	0	03/04	Gas Pressure	0 to 3.2767	kg/Cm ²	* 10 ⁻⁴
40021	0	03/04	Mid. Interface Level	0 to 32767	mm	
40022	0	03/04	Mid. Density	0 to 3.2767	g/Cm ³	* 10 ⁻⁴
40023	0	03/04	Bottom Density	0 to 3.2767	g/Cm ³	* 10 ⁻⁴
40024	0	06/16	Gauge Operation	0 to 10		Write Data
40025	0	16	Density Meas. Select	0 to 4		Write Data
40026	0	16	MEAS.POINT SELECT	2 to 16		Write Data
40027	0	16	I/F MANUAL LEVEL	0 to 65535	mm	Write Data
			Density Profile datas			
40028	0	03/04	Operation Status	0 to 5		
40029	0	03/04	Level Condition	0 to 3		
40030	0	03/04	Operation Time(DAY)	01 to 31		

Address	Page	Function Code	Item	Transfer Range	Unit	Note
40031	0	03/04	Operation Time(HOUR)	00 to 24		
40032	0	03/04	Operation Time(MIN.)	00 to 59		
40033	0	03/04	Average Density	0 to 3.2767	kg/Cm ²	* 10 ⁻⁴
40034	0	03/04	Average Temp.	-99.9 to 300.0	C	* 10 ⁻¹
40035	0	03/04	Mesured Density 01	0 to 3.2767	kg/Cm ²	* 10 ⁻⁴
40036	0	03/04	Mesured Density 02	0 to 3.2767	kg/Cm ²	* 10 ⁻⁴
40037	0	03/04	Mesured Density 03	0 to 3.2767	kg/Cm ²	* 10 ⁻⁴
40038	0	03/04	Mesured Density 04	0 to 3.2767	kg/Cm ²	* 10 ⁻⁴
40039	0	03/04	Mesured Density 05	0 to 3.2767	kg/Cm ²	* 10 ⁻⁴
40040	0	03/04	Mesured Density 06	0 to 3.2767	kg/Cm ²	* 10 ⁻⁴
40041	0	03/04	Mesured Density 07	0 to 3.2767	kg/Cm ²	* 10 ⁻⁴
40042	0	03/04	Mesured Density 08	0 to 3.2767	kg/Cm ²	* 10 ⁻⁴
40043	0	03/04	Mesured Density 09	0 to 3.2767	kg/Cm ²	* 10 ⁻⁴
40044	0	03/04	Mesured Density 10	0 to 3.2767	kg/Cm ²	* 10 ⁻⁴
40045	0	03/04	Mesured Density 11	0 to 3.2767	kg/Cm ²	* 10 ⁻⁴
40046	0	03/04	Mesured Density 12	0 to 3.2767	kg/Cm ²	* 10 ⁻⁴
40047	0	03/04	Mesured Density 13	0 to 3.2767	kg/Cm ²	* 10 ⁻⁴
40048	0	03/04	Mesured Density 14	0 to 3.2767	kg/Cm ²	* 10 ⁻⁴
40049	0	03/04	Mesured Density 15	0 to 3.2767	kg/Cm ²	* 10 ⁻⁴
40050	0	03/04	Mesured Density 16	0 to 3.2767	kg/Cm ²	* 10 ⁻⁴
40051	0	03/04	Mesured Position 01	0 to 65535	mm	
40052	0	03/04	Mesured Position 02	0 to 65535	mm	
40053	0	03/04	Mesured Position 03	0 to 65535	mm	
40054	0	03/04	Mesured Position 04	0 to 65535	mm	
40055	0	03/04	Mesured Position 05	0 to 65535	mm	
40056	0	03/04	Mesured Position 06	0 to 65535	mm	
40057	0	03/04	Mesured Position 07	0 to 65535	mm	
40058	0	03/04	Mesured Position 08	0 to 65535	mm	
40059	0	03/04	Mesured Position 09	0 to 65535	mm	
40060	0	03/04	Mesured Position 10	0 to 65535	mm	
40061	0	03/04	Mesured Position 11	0 to 65535	mm	
40062	0	03/04	Mesured Position 12	0 to 65535	mm	
40063	0	03/04	Mesured Position 13	0 to 65535	mm	
40064	0	03/04	Mesured Position 14	0 to 65535	mm	
40065	0	03/04	Mesured Position 15	0 to 65535	mm	
40066	0	03/04	Mesured Position 16	0 to 65535	mm	
			I/F Density profile datas			
40067	0	03/04	Operation Status	0 to 5		
40068	0	03/04	Level Condition	0 to 3		
40069	0	03/04	Operation Time(DAY)	01 to 31		
40070	0	03/04	Operation Time(HOUR)	00 to 24		
40071	0	03/04	Operation Time(MIN.)	00 to 59		
40072	0	03/04	Average Density	0 to 3.2767	kg/Cm ²	* 10 ⁻⁴
40073	0	03/04	Average Temp.	-99.9 to 300.0	C	* 10 ⁻¹
40074	0	03/04	Mesured Density 01	0 to 3.2767	kg/Cm ²	* 10 ⁻⁴
40075	0	03/04	Mesured Density 02	0 to 3.2767	kg/Cm ²	* 10 ⁻⁴

Address	Page	Function Code	Item	Transfer Range	Unit	Note
40076	0	03/04	Mesured Density 03	0 to 3.2767	kg/Cm ²	* 10 ⁻⁴
40077	0	03/04	Mesured Density 04	0 to 3.2767	kg/Cm ²	* 10 ⁻⁴
40078	0	03/04	Mesured Density 05	0 to 3.2767	kg/Cm ²	* 10 ⁻⁴
40079	0	03/04	Mesured Density 06	0 to 3.2767	kg/Cm ²	* 10 ⁻⁴
40080	0	03/04	Mesured Density 07	0 to 3.2767	kg/Cm ²	* 10 ⁻⁴
40081	0	03/04	Mesured Density 08	0 to 3.2767	kg/Cm ²	* 10 ⁻⁴
40082	0	03/04	Mesured Density 09	0 to 3.2767	kg/Cm ²	* 10 ⁻⁴
40083	0	03/04	Mesured Density 10	0 to 3.2767	kg/Cm ²	* 10 ⁻⁴
40084	0	03/04	Mesured Density 11	0 to 3.2767	kg/Cm ²	* 10 ⁻⁴
40085	0	03/04	Mesured Density 12	0 to 3.2767	kg/Cm ²	* 10 ⁻⁴
40086	0	03/04	Mesured Density 13	0 to 3.2767	kg/Cm ²	* 10 ⁻⁴
40087	0	03/04	Mesured Density 14	0 to 3.2767	kg/Cm ²	* 10 ⁻⁴
40088	0	03/04	Mesured Density 15	0 to 3.2767	kg/Cm ²	* 10 ⁻⁴
40089	0	03/04	Mesured Density 16	0 to 3.2767	kg/Cm ²	* 10 ⁻⁴
40090	0	03/04	Mesured Position 01	0 to 65535	mm	
40091	0	03/04	Mesured Position 02	0 to 65535	mm	
40092	0	03/04	Mesured Position 03	0 to 65535	mm	
40093	0	03/04	Mesured Position 04	0 to 65535	mm	
40094	0	03/04	Mesured Position 05	0 to 65535	mm	
40095	0	03/04	Mesured Position 06	0 to 65535	mm	
40096	0	03/04	Mesured Position 07	0 to 65535	mm	
40097	0	03/04	Mesured Position 08	0 to 65535	mm	
40098	0	03/04	Mesured Position 09	0 to 65535	mm	
40099	0	03/04	Mesured Position 10	0 to 65535	mm	
40100	0	03/04	Mesured Position 11	0 to 65535	mm	
40101	0	03/04	Mesured Position 12	0 to 65535	mm	
40102	0	03/04	Mesured Position 13	0 to 65535	mm	
40103	0	03/04	Mesured Position 14	0 to 65535	mm	
40104	0	03/04	Mesured Position 15	0 to 65535	mm	
40105	0	03/04	Mesured Position 16	0 to 65535	mm	
40106	1					page 01
:	:					
40210	1					
44096	39					page 39
:	:					
44200	39					

12 Appendix D

12.1 Alarm Processing

12.1.1 Outline

NRM determines alarm status (an upper or a lower limit) based on set values registered in the matrices and on measured data (level, temperature, and volume data). Based on this data, it calculates whether the relevant value exceeds the upper or lower limit, the system definition of an alarm. If an alarm condition does exist, NRM activates a buzzer while flashing a corresponding LCD indicator. Pressing the [ALARM ACT] key stops the buzzer and causes the LCD indicator to light.

[022] ALARM HISTORY stores data for up to ten alarm events. Acknowledging an alarm (by pressing the [ALARM ACK] switch) turns off the LCD indicator, but previous alarms are displayed in [022]ALARM HISTORY. When data for more than 10 alarms accumulates, the oldest data is deleted every time new data is received.

12.1.2 Alarm setting

12.1.2.1 Alarm Setting [240]-[243]

There are 4 matrix positions regarding to alarm settings.

LABEL	[240] ALARM SELECT	[241] ALARM ASSIGN.	[242] SET POINT	[243] ALARM ASSIGN.
EXAMPLE 1	POINTER No.0	LEVEL	600 mm	LOW ALARM
EXAMPLE 2	POINTER No.1	LEVEL	18000 mm	HIGH ALARM

- **[240] ALARM SELECTION (alarm output pointer)**

Input the Point Number (from 0 to 7). You can set an alarm up to 8 points.

- **[241] ALARM ASSIGNMENT (alarm output type)**

Select one from the following alarm types.

- **NONE:** No alarm processing is executed.
- **LEVEL:** An alarm calculation is executed based on the level data in [000].
- **TEMP.:** An alarm calculation is executed based on the temperature data in [001].
- **GROSS VOL.:** An alarm calculation is executed based on gross volume data in [002].
- **NET VOL.:** An alarm calculation is executed based on net volume data in [003].
- **MASS:** An alarm calculation is executed based on weight data in [004].

- **[242] SET POINT (alarm set value)**

This matrix registers an alarm set value (an upper or a lower limit) corresponding to the "alarm output type" set in [242] SET POINT. the range of the registered value is shown below.

- LEVEL: 0 -99999 mm
- TEMP.: -99.9 - 300.0 °C
- GROSS VOL.: 0-999999.999 kl
- NET VOL.: 0 - 999999.999 kl
- MASS: 0 -999999.999 ton

- **[243] ALARM ASSIGNMENT (alarm output made)**

This matrix registers data indicating whether the alarm at each pointer is treated as an upper or lower limit alarm.

- HIGH ALARM: An upper limit
- LOW ALARM: A lower limit

- **Go back to [240] to set another alarm point. Set up to 8 alarm points following 1-4.**

12.1.2.2 Alarm Hysteresis Setting [355]-[358]

Set the hysteresis for alarm setting. In the example above, there are two alarms for level. If the level exceeded 18000 mm, HIGH ALARM will off. If you set hysteresis for 2 mm at [355] LEV. ALAM HYST, the alarm will continue until the level comes back to 18000 - 2 = 17998 mm. This set value is also applied for LOW ALARM. The alarm goes off after the level passes 602 mm.

You only need to set the hysteresis for alarms that are set. For example, if VOLUME alarm is not set you do not need to set a hysteresis for [357] VOL. ALARM HYST.

- [355] LEV. ALARM HYST: level alarm hysteresis setting (0 - 999 mm)
- [356] TEMP. ALARM HYST: temperature alarm hysteresis setting (0 - 99.9 °C)
- [357] VOL. ALARM HYST: gross/net volume alarm hysteresis setting (0 - 99.999 kl)
- [358] MASS ALARM HYST: mass alarm hysteresis setting (1 - 99.999 kl)

12.1.3 Alarm Calculations

12.1.3.1 Alarm Hysteresis Calculation

The system provides for a certain latitude in alarm output to prevent alarms repeatedly switching on and off, due to slight variations as measured quantities approach any of the set limit values.

Example: Upper limit alarm

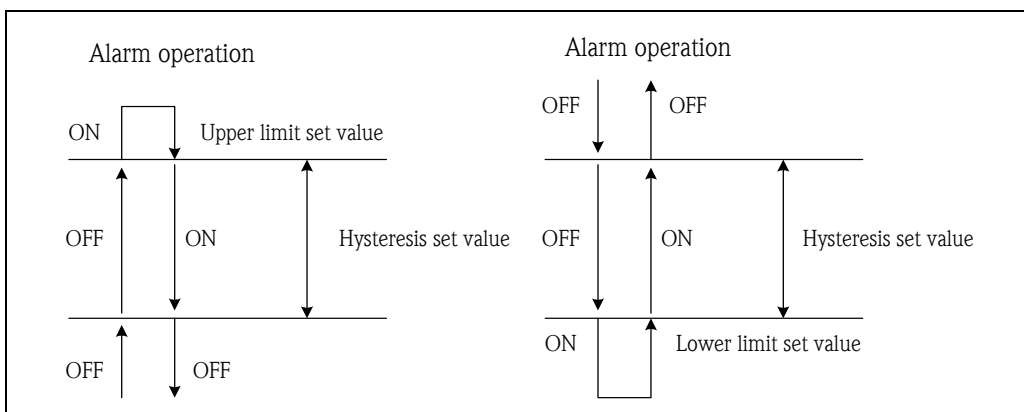

12.1.3.2 Level Alarm Calculations

- Level upper limit alarm calculation

Rising	$Lx - Ls \geq 0$: Alarm on
Falling	$Lx - Ls + Lh < 0$: Alarm off

Lx: Value of measured level in [000] MEASURED LEVEL
 Ls: Value registered in [242] SET POINT
 Lh: Level alarm hysteresis in [355] LEV. ALARM HYST

- Level lower limit alarm calculation

Rising	$Lx - Ls \leq 0$: Alarm on
Falling	$Lx - Ls - Lh > 0$: Alarm off

12.1.3.3 Temperature Alarm Calculations

- Upper Limit Alarm calculation

Rising	$Tx - Ts \geq 0$: Alarm on
Falling	$Tx - Ts + Th < 0$: Alarm off

Tx : Temperature of measured liquid in [001] LIQUID TEMP.
 Ts: Value registered in [242] SET POINT
 Th: Temperature alarm hysteresis in [356] TEMP. ALARM HYST

- Lower Limit Alarm calculation

Rising	$T_x - T_s \leq 0$: Alarm on
Falling	$T_x - T_s - T_h > 0$: Alarm off

12.1.3.4 Gross volume Alarm Calculations

- Upper Limit Alarm calculation

Rising	$VG_x - VG_s \geq 0$: Alarm on
Falling	$VG_x - VG_s + V_h < 0$: Alarm off

VGx: Gross volume in [002] GROSS VOLUME
 VGs: Value registered in [242] SET POINT
 Vh: Gross volume alarm hysteresis in [357] VOL. ALARM HYST

- Lower Limit Alarm Calculation

Rising	$VG_x - VG_s \leq 0$: Alarm on
Falling	$VG_x - VG_s - V_h > 0$: Alarm off

12.1.3.5 Net Volume Alarm Calculations

- Upper Limit Alarm Calculation

Rising	$VN_x - VN_s \geq 0$: Alarm on
Falling	$VN_x - VN_s + V_h < 0$: Alarm off

VNx: Net volume in [003] NET VOLUME
 VNs: Value registered in [242] SET POINT

- Lower Limit Alarm calculation

Rising	$VN_x - VN_s \leq 0$: Alarm on
Falling	$VN_x - VN_s - V_h > 0$: Alarm off

12.1.3.6 Net Weight Alarm Calculations

- Upper Limit Alarm Calculation

Rising	$WN_x - WN_s \geq 0$: Alarm on
Falling	$WN_x - WN_s + W_h < 0$: Alarm off

WNx: Net weight in [004] MASS
 WNs: Value registered in [242] SET POINT
 Wh: Weight alarm hysteresis in [358] MASS ALARM HYST

■ Lower Limit Alarm Calculation

Rising	$WN_x - WN_s \leq 0$: Alarm on
Falling	$WN_x - WN_s - Wh > 0$: Alarm off

12.1.4 Alarm Display

TANK NO. 0001
LEVEL 15422 mm
TEMP. 0.0 °C
0001 LEVEL H

If any of above alarms occur, the fourth line of the Home Position displays the following. And the fourth line blinks.



Note!
The Matrix screen displays on alarm (the buzzer is activated).

Alarm output type	Alarm output mode	Display format		
1. Level	0 : Upper limit	XXXX (*1)	LEVEL	H
	1 : Lower limit	XXXX	LEVEL	L
2. Liquid temperature	0 : Upper limit	XXXX	TEMP.	H
	1 : Lower limit	XXXX	TEMP.	L
3. Gross volume	0 : Upper limit	XXXX	G-VOL.	H
	1 : Lower limit	XXXX	G-VOL.	L
4. Net volume	0 : Upper limit	XXXX	N-VOL.	H
	1 : Lower limit	XXXX	N-VOL.	L
5. Net weight	0 : Upper limit	XXXX	MASS	H
	1 : Lower limit	XXXX	MASS	L

(*1) : XXXX = tank number registered in [182] TANK NUMBER

12.1.5 Alarm Acknowledgment

If an alarm condition does exist, NRM activates a buzzer while flashing a corresponding LCD indicator. Pressing the [ALARM ACK] key stops the buzzer and stops the LCD indicator blinking.

12.1.5.1 At Home Position

■ Alarm occurrence

If multiple alarms occur simultaneously, the system can only display data for one event, due to the limited display space of LCD. The alarms can be sequentially displayed by continuously pressing the [ALARM ACK] key following acknowledgment of the first alarm.

■ Alarm re-acknowledgment

Alarm re-acknowledged, the LCD returns to normal display of data for level, temperature, and volume. If the [ALARM ACK] key is pressed at this point, the system displays alarm data for the which the alarm is set off. Keep pressing [ALARM ACK] key until alarm data is deleted.

12.1.5.2 At Matrix Position

The Matrix screen displays no alarm data. Only the buzzer is activated when an alarm occurs. To acknowledge an alarm, return to the Home Position and press the [ALARM ACK] key.

13 Appendix E

13.1 Value Allowance & Error Retry Setting [372]-[375]

Set the following matrices to determine how to detect errors.

- [372] LEV.CHANG.ALLOW (Level change allowance)
Using + or -, set the permitted limit for level variation.
- [373] TEMP. CHANG. ALLOW (Temperature change allowance)
Using + or -, set the permitted limit for temperature variation.
- [374] LEV. RETRY NO.(Level Retry number)
Using + or -, set the number of retries for level variation checking.
- [375] TEMP. RETRY NO.(Temperature Retry number)
Using + or -, set the number of retries for temperature variation checking.

13.2 Error Types

If any error is detected during NRM operation, the system displays the following error comment to indicate that an error has occurred. In general, errors can be classified into the following three types.

- System error: Major error or defect in NRM
- Sensor communication error: Error in communication with sensor
- Sensor error:

In error processing, priority is given to this order as follows.

1. System errors
2. Sensor communication
3. Sensor errors

13.2.1 System Error

NRM constantly checks data in internal and displays an error if it occurs. The system error is continuously displayed in both Home Position and Matrix Position.

Error display	Contents	Action
V1 CPU ERROR	Defect in the V1 CPU	Replace board
MAIN CPU ERROR	Defect in the main CPU	Replace board

13.2.2 Sensor Communication Error

NRM constantly collects data through free scanning, and if it detects an error during this operation based on communication with the sensor, displays that error.

Error number	Contents	Action
1	Start code error in old communication	The cable linking NRM and sensor may be damaged or shorted
2	Total mark error in old communication	Noise. Find noise source.
3	Data reading-twice mismatch in old communication	Noise. Find noise source.
4	Select error in old communication	the select code for the sensor is set incorrectly.
5	Level BCD error	Repair the level encoder in the sensor
6	Level variation error	Noise. Repair the level encoder in the sensor.
7	Temperature variation error	Noise. Inspect and repair the temperature sensor.
8	STX cannot be detected in V1 communication	The cable between NRM and the sensor may be damaged and shorted.
9	Parity error in V1 communication	Noise. Find noise source.
10	Physical address error in V1 communication	The select code for the sensor is set incorrectly
11	Data address error in V1 communication	Communication protocol error.
12	ETX cannot be detected in V1 communication	Noise. Find noise source
13	CHC error in V1 communication	The cable between NRM and the sensor may be short-circuited due to damage.

13.2.3 Sensor Error

The sensor detects the errors listed below and communicates them to NRM, which then displays the received errors. To find error cause and the action to be taken, refer to the particular sensor's operating manual.

13.3 Tank Number List

To avoid confusion we strongly recommend that you make a tank number list before operating the NRM.

Page No.	Tank No. Default	Tank No. set by Customer	Polling Address
00	01		
01	02		
02	03		
03	04		
04	05		
05	06		
06	07		
07	08		
08	09		
09	10		
10	11		
11	12		
12	13		
13	14		
14	15		
15	16		
16	17		
17	18		
18	19		
19	20		
20	21		
21	22		
22	23		
23	24		
24	25		
25	26		
26	27		
27	28		
28	29		
29	30		
30	31		
31	32		
32	33		
33	34		
34	35		
35	36		
36	37		
37	38		
38	39		
39	40		

www.endress.com/worldwide

Endress+Hauser 
People for Process Automation