

Temperature *Prothermo* *NMT 535*

Operating Manual



Table of Contents

1. Safety instructions	3
1.1 Designated use	3
1.2 Installation, commissioning and operation	3
1.3 Operational safety	3
1.4 Notes on safety conventions and symbols	4
2. Identification	5
2.1 Device Designation	5
3. Installation	10
3.1 Installation conditions	10
3.2 Installation instructions	11
4. Wiring	21
4.1 Required Cabled Ground and Cable	21
4.2 Wiring Procedure	21
5. Operation	22
5.1 Operating on Matrix While Connected to	22
the Proservo NMS 53x	
5.2 Setting the Matrix on a Proservo NMS 53x	27
5.3 Programming Matrix	28
5.4 Description of the Programming Matrix	33
6. Error Codes	37
6.1 Short Circuit or Break	37
6.2 Communication Error	37
6.3 Error and Status Messages	37
7. Appendix	40

1 Safety instructions

1.1 Designated use

The NMT 535 is a combined average temperature signal converter and element probe used on bulk storage tanks for inventory control and custody transfer applications. The NMT 535 can be combined with various HART compatible devices and tank sensors, such as Endress + Hauser's Proservo NMS 53x, Micropilot M and S-series radar and Tank Side Monitor NRF 590. The Prothermo NMT 535 measures the average product temperature and converts the input to HART compatible output. The temperature data is used for the calculation of the volume correction factor (VCF) and the Net Standard Volume (lower case) required for accurate inventory measurement.

1.2 Installation, commissioning and operation

- Mounting electrical installation, start-up and maintenance of the instrument may only be carry out by trained personnel authorized by operator of the facility.
- Personnel must absolutely and without fail read and understand this Operating Manual before carrying out its instructions.
- The instrument may only be operated by personnel who are authorized and trained by the operator of the facility. All Instructions in this Manual are to be observed without fail.
- The installer has to make sure that the measuring system is correctly wired according to the wiring diagrams. The measuring system is to be grounded.
- Please observe all provisions valid for your country and pertaining to the opening and repairing of electrical devices.

1.3 Operational safety

Proper use

Warning!

- The Prothermo NMT535 temperature elements assume that users gauge temperature inside the liquid tanks. Use for purposes other than originally intended may cause failure. Failure may occur if the elements are positioned incorrectly or as a result of improper operation. Carefully read this instruction manual before attempting to use the elements.
- Before opening the cover of the Prothermo NMT535 for maintenance, switch off the power supply of the Proservo NMS53x. The Prothermo NMT535 is supplied with electric power from the Proservo NMS53x.

Protection from line noise

Caution!

- The following precautions are required to rule out any malfunction by line noise (see also Sect. 7.2).
- Use a more than 24 AWG screened twisted pair or steel armored wire for the connection between the Prothermo NMT535 and the Proservo NMS53x or the Tank side monitor NRF 590.
 - If you use an unscreened wire, then equip it with a conduit pipe.
 - Connect the cable screen to the frame ground.

On safety and improper use

Follow the safeguards presented in this manual when using this product. This is important for ensuring the safe operation of the system to be controlled by the product. If the user does not follow these instructions properly, we cannot guarantee the safety of the system.

Product Requirements

Power source

Check the voltage of the power supply before connecting it to the product. It should be the exact voltage required for proper operation of the product.

Use in hazardous areas

When using the product in a first or second-class hazard location (Zone 1 or Zone 2) be sure to

use an intrinsically safe or pressure- and explosion-proof apparatus. Take the utmost care during the installation, wiring, and piping of such an apparatus to ensure the safety of the system. For safety reasons, maintenance or repairs on the product while it is being used with such an apparatus should only be performed by qualified personnel.



External connection



When an external connection is required, the product should be protectively grounded before it is connected to a measurement object or an external control circuit.





1.4 Notes on safety conventions and symbols

In order to highlight safety-relevant or alternative operating procedures in the manual, the following conventions have been used, each indicated by a corresponding symbol in the margin.

Safety conventions

Symbol	Meaning
	Warning A warning highlights actions or procedures which, if not performed correctly, will lead to personal injury, a safety hazard or destruction of the instrument.
	Caution! Caution highlights actions or procedures which, if not performed correctly, may lead to personal injury or incorrect functioning of the instruments.
	Note! A note highlights actions or procedures which, if not performed correctly, may indirectly affect operation or may lead to an instrument response which is not planned.

	Device certified for use in explosion hazardous area If the Micropilot has this symbol embossed on its name plate it can be installed in an explosion hazardous area.
	Explosion hazardous area Symbol used in drawings to indicate explosion hazardous area. - Devices located in and wiring entering areas with the designation "exolosion hazardous areas" must conform with the stated type of protection.
	Safe area (non-explosion hazardous area) Symbol used in drawings to indicate, if nesessary, non-explosion hazardous areas. - Devices located in safe areas still require a certificate if their outputs run into explosion hazardous areas.

	Direct voltage A terminal to which or from which a direct current or voltage may be applied or supplied
	Alternating voltage A terminal to which or from which an alternationg (sine-wave) current or voltage may be applied or supplied
	Grounded terminal A grounded terminal, which as far as the operator is concerned, is already grounded by means of an earth grounding system.
	Protective grounded (earth) terminal A terminal which must be connected to earth ground prior to making any other connection to the equipment.
	Equipotential connection (earth bonding) A connection made to the plant grounding system which may be of type e.g. neutral star or equipotential line according to national or company practice

2 Identification

2.1 Device Designation

2.1.1 Nameplate

The following technical data are given on the instrument nameplate:

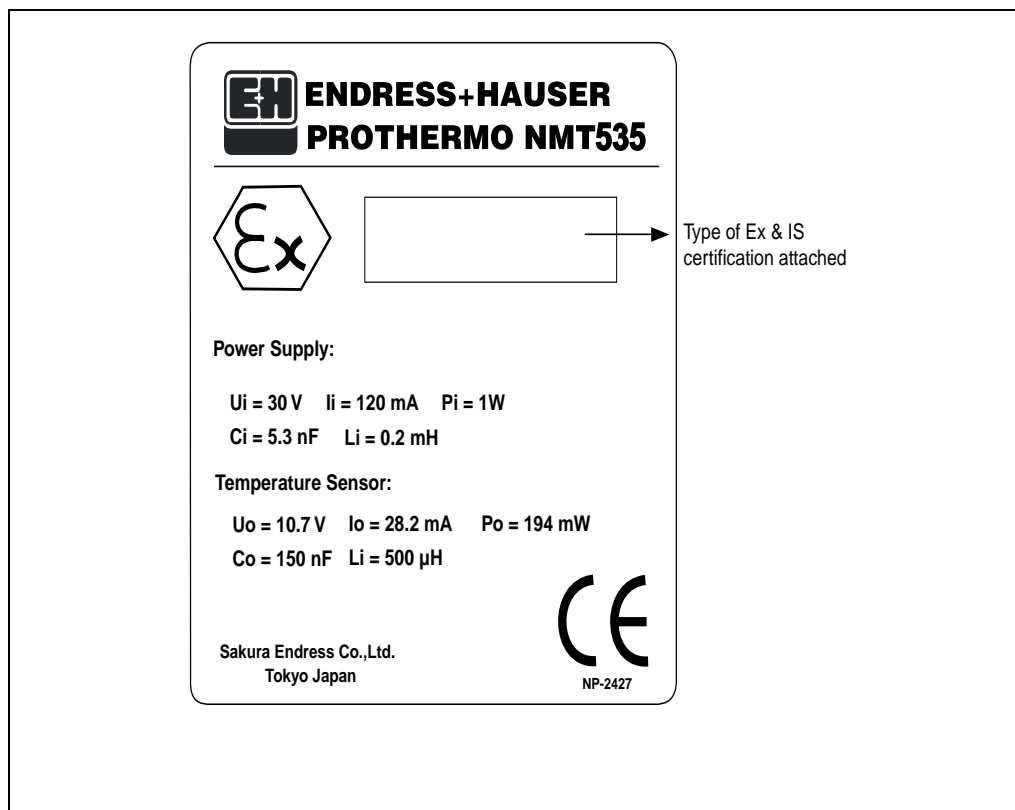

2.1.2 Ordering Information

10	Protection class				
	0	IP 67			
	1	Ex d IIB T4, IIIS			
	2	EEx ia IIB T4, ATEX			
	3	EEx ia IIB T2, ATEX			
	4	XP Class 1, Div. 1, Gp. CD, FM.....pending			
	5	Class 1, Div 1, Gp. CD, CSA (Exd).....pending			
	6	EEx d IIB T4, ATEX.....pending			
	7	IS Class 1, Div 1, Gp. CD, FM			
	8	Class 1, Div 1, Gp. CD, CSA (Exi).....pending			
	9	Special version			
20	Cable Entry				
	A	One G(PF) ½" thread			
	B	One NPT ½" thread			
	C	One PG 16 (only Protection class 0)			
	D	One M 20 thread			
	Y	Special version			
30	Process connection, material				
	0	JIS 10K 50A RF flange			
	1	ANSI 2" 150lbs RF flange			
	2	DIN DN50 PN10 RF flange			
	3	JPI 2" 150lbs RF flange			
	9	Special version			
40	Flange material				
	0	Carbon steel (JIS SS400) flange			
	1	Stainless steel (SUS304) flange			
	9	Special version			
50	Measuring range				
	1	-50 to +200 °C, -58 to +392 °F (wide range)			
	2	-20 to +100 °C, -4 to +212 °F (standard range)			
	3	-18 to + 80 °C, 0 to +176 °F (PTB W&M)...pending			
	4	-50 to +200 °C, -58 to +392 °F (wide range)...High Accuracy, pending			
	5	-20 to +100 °C, -4 to +212 °F (standard range)... High Accuracy, pending			
	9	Special version			
60	Number of elements				
	A	Two Pt100			
	B	Three Pt100			
	C	Four Pt100			
	D	Five Pt100			
	E	Six Pt100			
	F	Seven Pt100			
	G	Eight Pt100			
	H	Nine Pt100			
	J	Ten Pt100			
	K	Eleven Pt100			
	L	Twelve Pt100			
	M	Thirteen Pt100			
	N	Fourteen Pt100			
	O	Fifteen Pt100			
	P	Sixteen Pt100			
	Y	Special version			
70	Element spacing				
	1	Element Spacing: 2000mm			
	2	Element Spacing: 1500mm			
	3	Element Spacing: 1000mm			
	4	Elements equally spaced defined by length and element number			
	9	Special version			
80	1,000 to 30,000mm probe length (below flange)				
	Amm probe length			
90	Display 1,000 to 30,000mm probe length (below flange)				
	A	No display			
NMT535-					

2.1.3 Specification

measuring element	Platinum (Pt.100), Class A element (standard type) PUB 751 1983 and / or JIS 1604 0 1989
Accuracy of element	$\pm(0.15+0.002 t)$ °C, $\pm(0.3+0.004 t)$ °F (standard)
Accuracy of conversion	$\pm 0.25^{\circ}\text{C}$ ($\pm 0.5^{\circ}\text{F}$), at admissible temperature
Total Accuracy	$\pm\{0.25+(0.15+0.002 t)\}$ °C, $\pm\{0.5+(0.3+0.004 t)\}$ °F
Total Accuracy (High Accuracy) version	$\pm 0.25^{\circ}\text{C}$ ($\pm 0.5^{\circ}\text{F}$) within API chapter 7 MPMS specifications at reference condition.....pending
Measuring range	20... + 100 °C, -4... +212 °F (standard) 50... + 200 °C, -58... +392 °F (wide range) 18... + 80 °C, 0... +176 °F (PTB W&B)..... pending High Accuracy version available for two temp. ranges within API MPMS, chapter 7 specifications at reference condition
Number of elements	2 to 16 points
Flange	JIS 10K 50A RF ANSI 150 lbs. 2" RF JPI 150 lbe. 2" RF DIN DN50 PN10RF Others (optional)
Output	Multidrop HART Protocol Polling address: 02 for connecting to Proservo NMS 53x. Polling address: 01-0F without Proservo NMS 53x
Materials	Flexible tube (Inner tube): Stainless steel 316 grade Flexible tube (Outer tube): Stainless steel 304 grade Housing: Aluminium diecast ¾" threaded Flange: Mild steel (standard), SS 304 / 316 (optional)
Power supply	DC 17-30V (NMS 53x & eliminate NRF590 Supplies DC24V)
Cable entry	G (PF) ½ NPT ½ PG16 M20
Ambient temperature	-20... +60 °C, -4...+140 °F Converter (housing)

Explosion proof	Ex d IIB T4, TIIIS EEx ia IIB T4 and T2 ATEX XP Class 1, Div.1, Gp. CD, FM.....pending Class 1, Div.1, Gp.CD, CSA (Exd).....pending EEx d IIB T4, ATEX.....pending IS Class 1, Div.1, Gp.CD, FM Class 1, Div.1, Gp. CD, CSA (Exi).....pending
Element position (standard)	Lowest 100mm (3.9") above bottom of flexible tube Highest 1000 mm (39.4") below flange surface
Flexible tubu of cable bottom	400 mm from tank bottom

3 Installation

3.1 Installation conditions

3.1.1 Dimensions

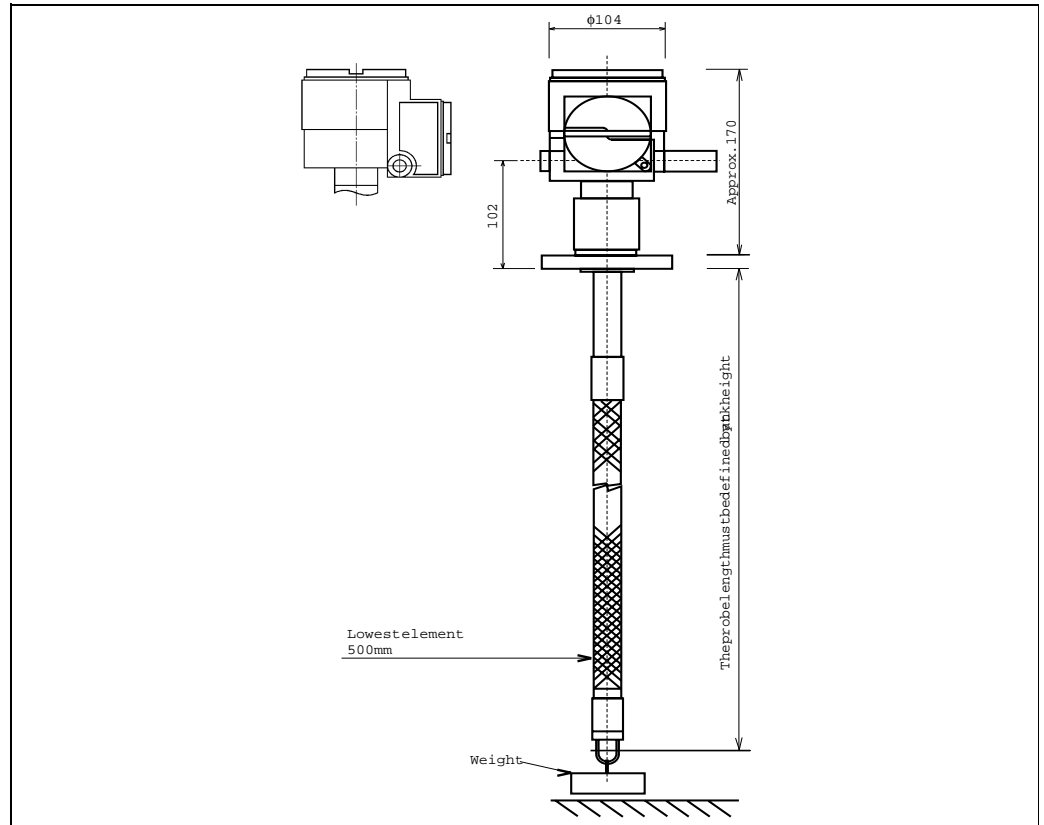

3.2 Installation instructions

3.2.1 Mounting

Note!

1) The flexible tube or cable length of the Prothermo NMT535 is defined for the customer's specifications. Before mounting check them as follows;

- The tag number (if available) on the body of the Prothermo NMT535
- The length of the flexible tube or cable
- The number of measuring points
- The intervals between measuring points



Note!

2) Mount the Prothermo NMT535 at least 500 mm away from the tank shell. This will insure that the measurement is not influenced by changes of the ambient temperature.

3) The procedure for mounting the Prothermo NMT535 on a tank depends on the type of the tank. Here we shall explain the procedures for a fixed roof tank and for a floating roof tank. In any case, the flexible tube head is mounted on the tank top. The mounting nozzle should have a diameter of 2" (standard).

Warning!

NMT535 is not design to use in over atmospheric pressure. Please install NMT535 with pressure tight still well for the safety.



Warning!

Mounting of the flexible tube head the tank top

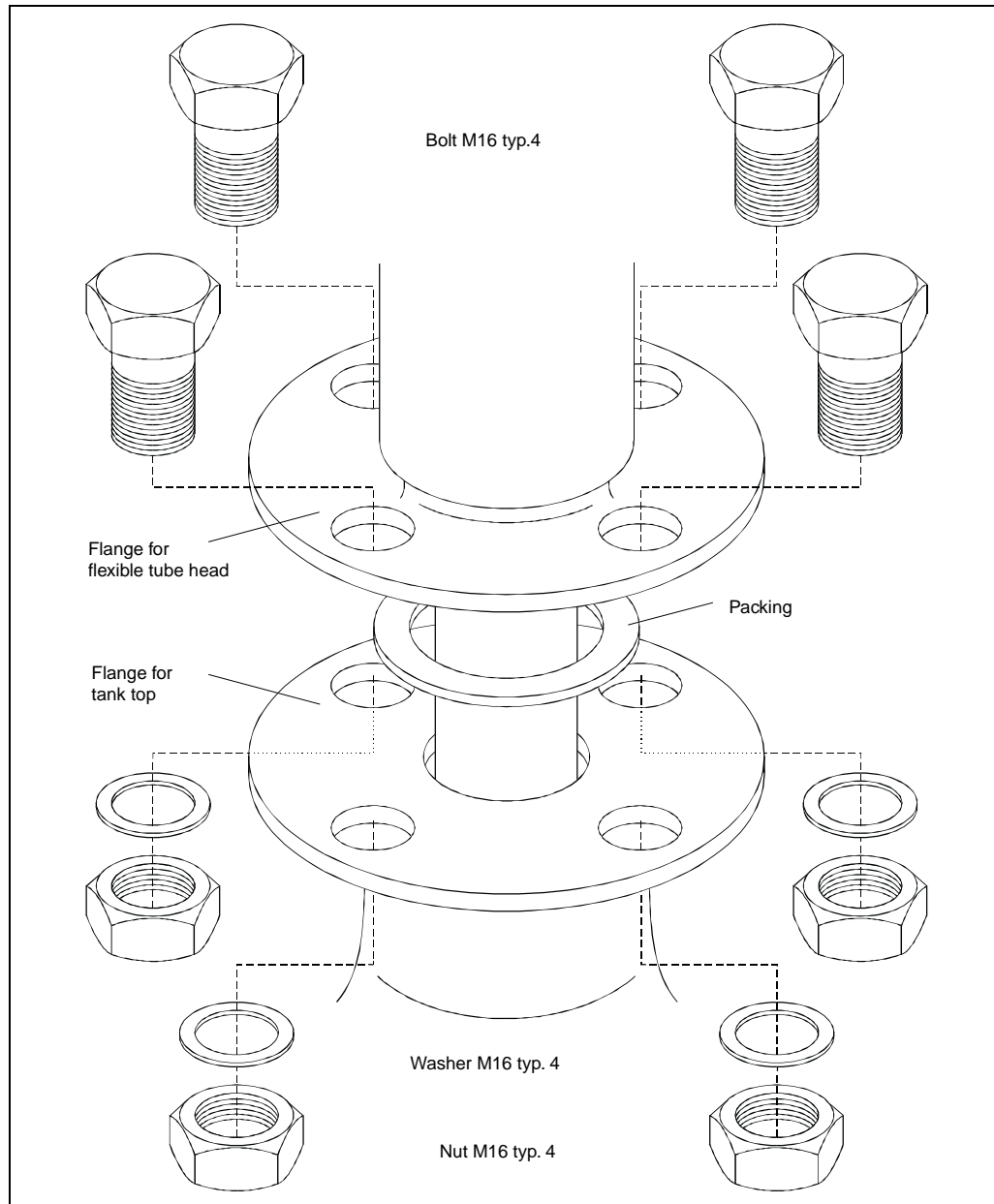

3.2.2 Mounting on a Fixed Roof Tank

There are three methods of mounting the Prothermo NMT 535 on a fixed roof tank:

- 1) Top anchor method
- 2) Stilling well method
- 3) Anchor weight method

3.2.2.1 Top Anchor Method

The flexible tube is stabilized by a wire hook and a top anchor.

Mounting on a fixed roof tank by the top anchor method

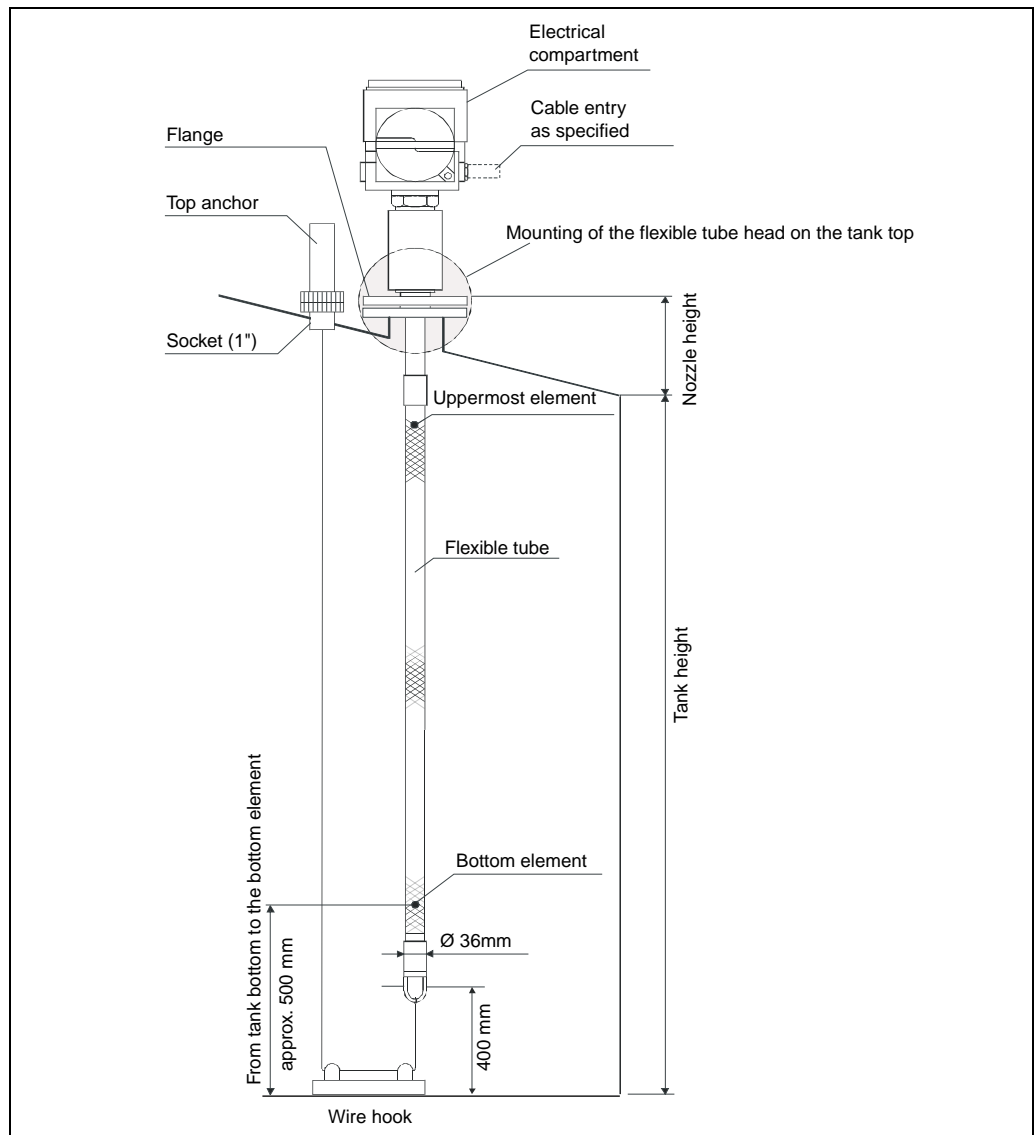

Note!

Note!

If the tank bottom is equipped with a heating coil, then increase the distance between flexible tube and bottom accordingly.

The installation procedure comprises the following steps:

- 1) Install a gasket and lower the flexible tube into the nozzle on the tank top.



Caution!

Caution!

The flexible tube must be lowered carefully to prevent damage by touching the nozzle.

- 2) Rotate the Prothermo NMT535 such that you can most conveniently set the cabling.
- 3) Straighten the tensioning wire, fix its end provisionally to the anchor, and lower the wire.
- 4) Draw the tensioning wire through the wire hook on the tank bottom.
- 5) Wind the tensioning wire twice round the hitch, tighten it, and wrap a commercial wire round it.

Setting of the tensioning wire on the tank bottom

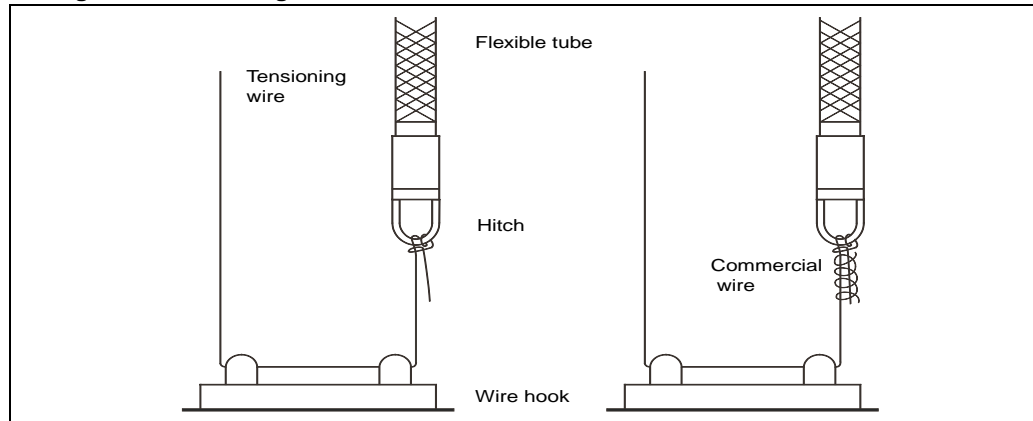

Fixing of the tensioning wire to the top anchor

- 6) Fix the mounting flange of the Prothermo to the nozzle on the tank top by bolts
- 7) Draw the end of the tensioning wire as much as possible by hand and foot.
- 8) Bend the wire and fix it by the tightening nut
- 9) Cut the excess wire.
- 10) Scw the bolt and press down the spring of the top anchor by 35mm or more.
- 11) Cover the top anchor

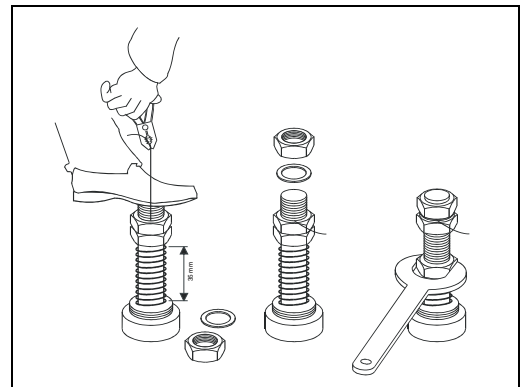

3.2.2.2 Stilling Well Method

The flexible tube is inserted into a stilling well a diameter of 2" or more

Mounting on a fixed roof tank by the stilling well method

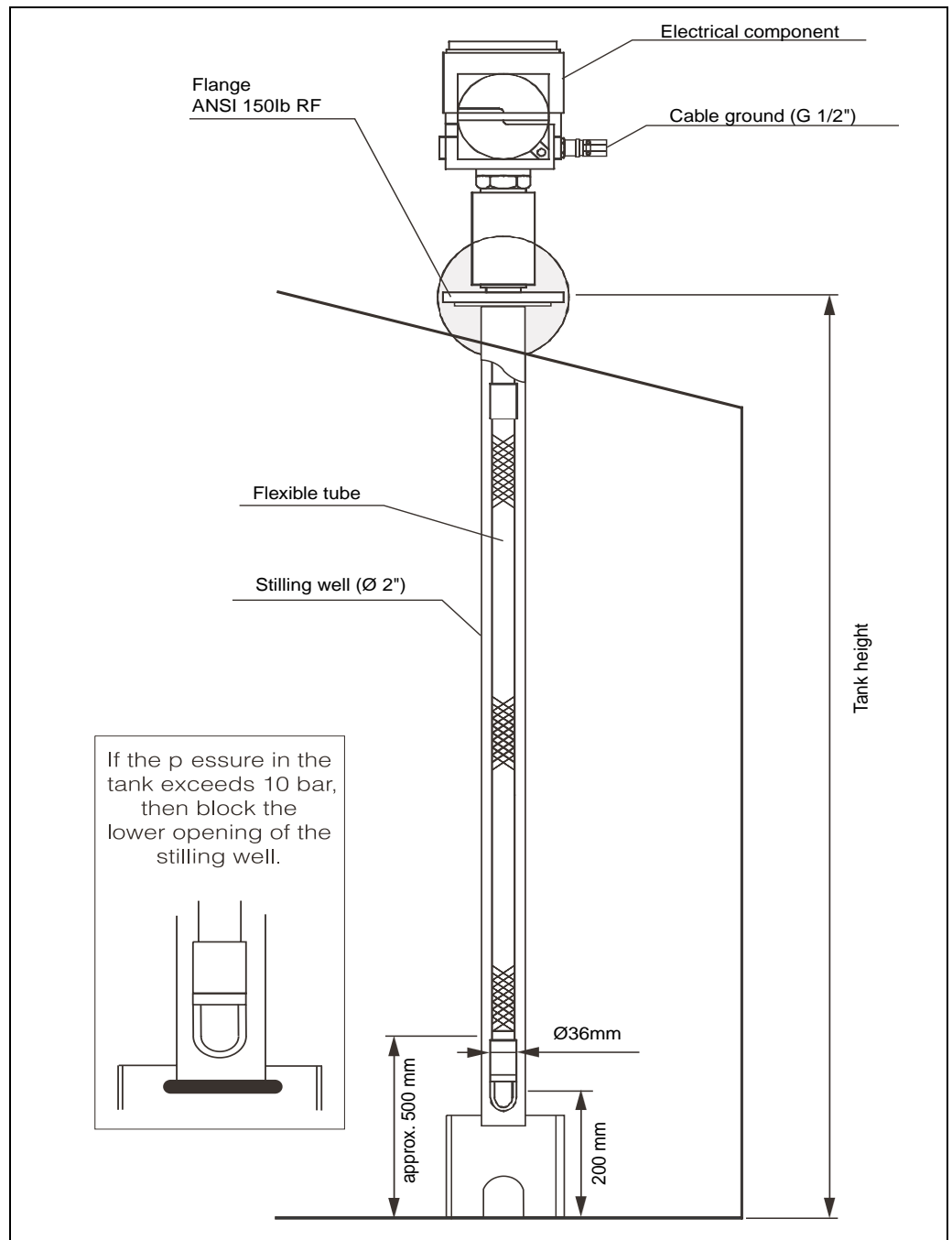

Note!

Note!

If the tank bottom is equipped with a heating coil, then increase the distance between flexible tube and bottom accordingly.

The installation procedure comprises the following steps:

- 1) Install a gasket and lower the flexible tube into the inlet of the stilling well.



Caution!

The flexible tube must be lowered carefully to prevent damage by touching the nozzle.

- 2) Rotate the Prothermo NMT535 such that you can most conveniently set the cabling.
- 3) Fix the mounting flange of the prothermo NMT535 to the nozzle on the tank top by a bolt.

3.2.2.3 Anchor Weight Method

The flexible tube is stabilized by an anchor weight.

Mounting on a fixed roof tank by the anchor weight method

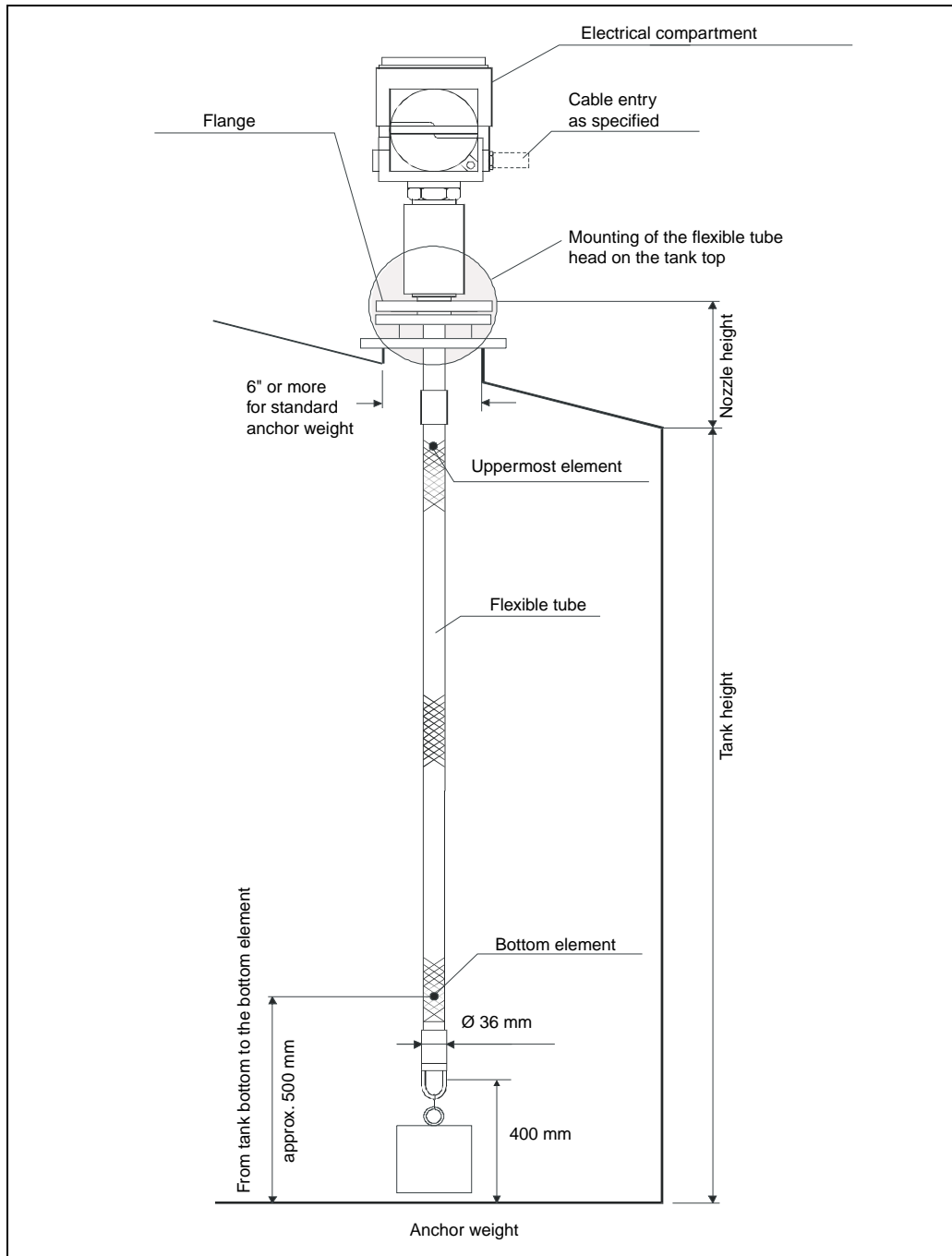



Note!

Note!

If the tank bottom is equipped with a heating coil, then increase the distance between flexible tube and bottom accordingly

The installation procedure comprises the following steps:

1) Install a gasket and lower the flexible tube into the nozzle on the tank top.



Caution!

Caution!

The flexible tube must be lowered carefully to prevent damage by touching the nozzle.

2) Rotate the Prothermo NMT 535 such that you can most conveniently set cabling.

3) Tighten the tensioning wire between the lower end of the flexible tube and the anchor weight.

4) Wind the tensioning wire twice round each of the hitches and the anchor weight.



Note!

Note!

Make sure that the anchor weight is hanging steadily about 10...15mm above the tank bottom. The exact distance depends on the tank height and the type of liquid.

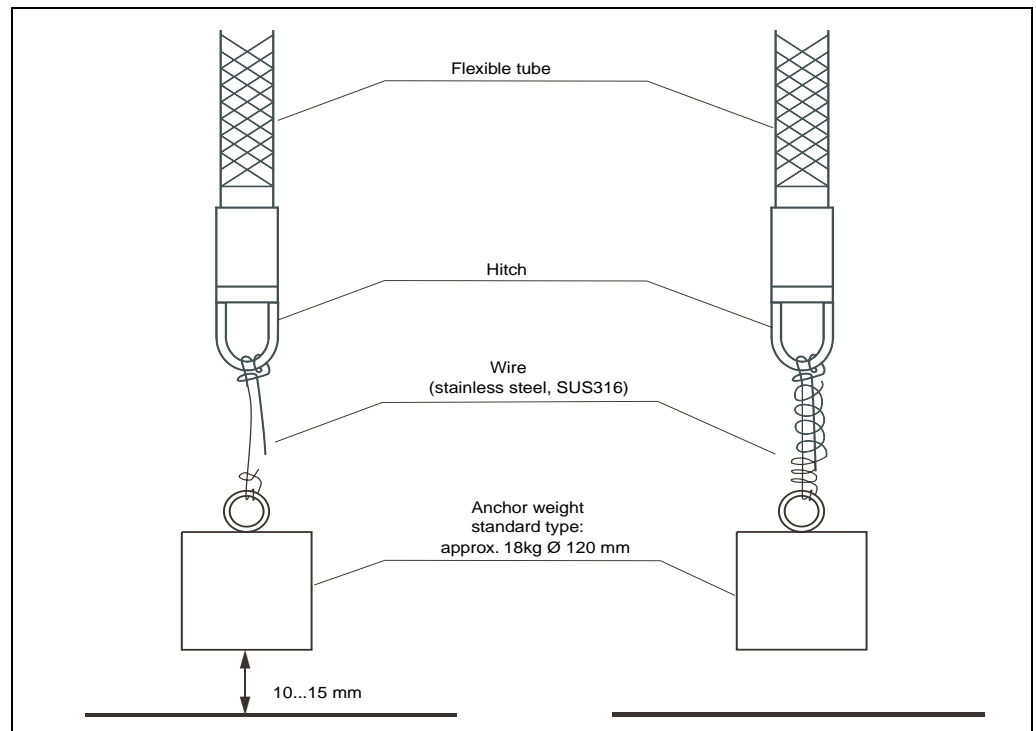
Setting of the anchor weight above the tank bottom

5) Fix the mounting flange of the Prothermo NMT535 to the nozzle on the tank top by bolts.

3.2.3 Mounting on a Floating Roof Tank

There are three methods of mounting the Prothermo NMT 535 on a floating roof tank:

- 1) Top anchor method
- 2) Stilling well method
- 3) Guide wire ring method

3.2.3.1 Top anchor method and stilling well method

The flexible tube is installed in a stilling well and, if required, stabilized by a top anchor. The Proservo NMS 53x. and the prothermo NMT 535 can be mounted in the same stilling well.

Mounting on a floating roof tank in a stilling well and/or by the top anchor method

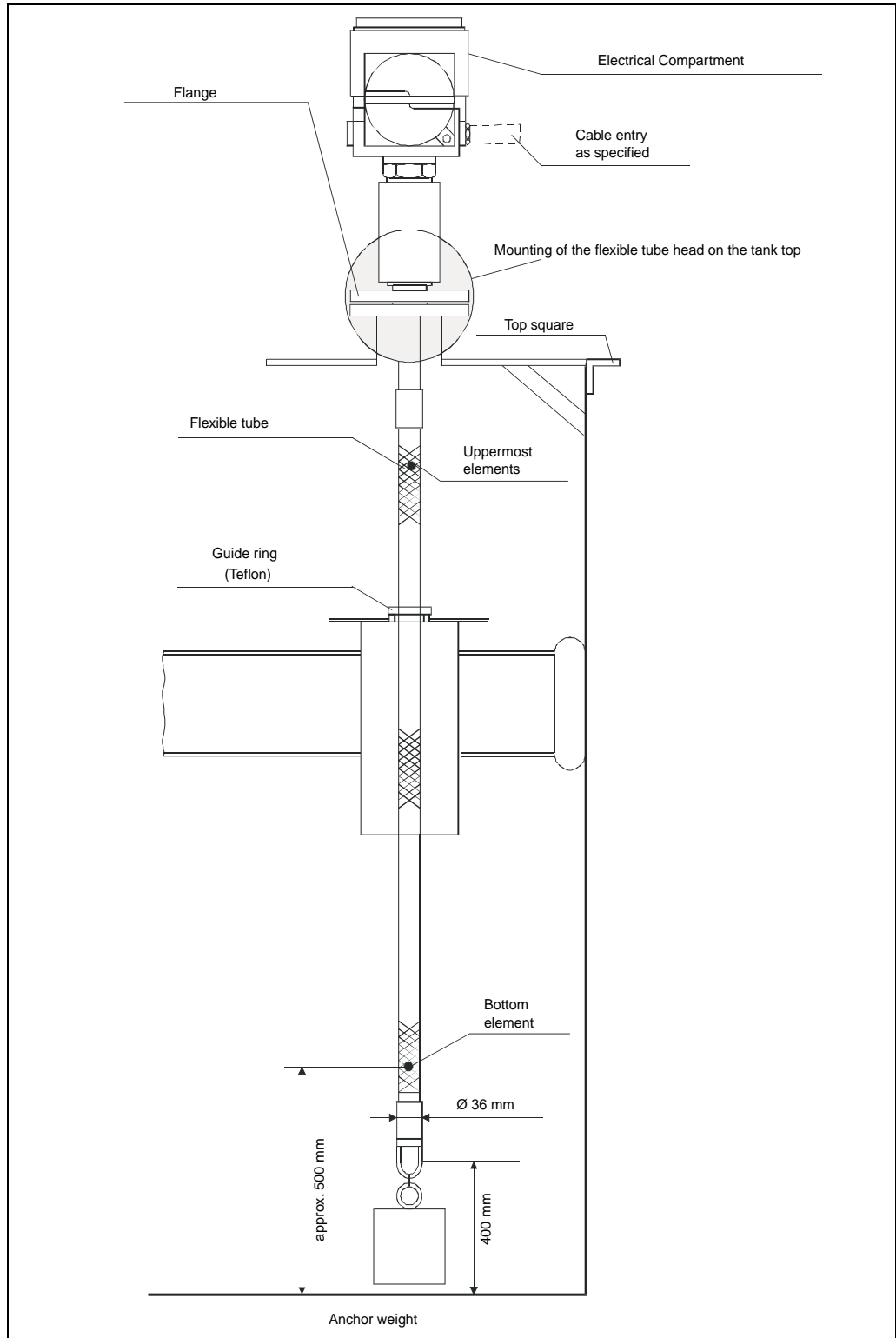



Note!

Note!

If the tank bottom is equipped with a heating coil, then increase the distance between flexible tube and bottom accordingly.

The installation procedure is same for mounting on a fixed roof tank by the top anchor method.

3.2.3.2 Guide Wire Ring Method

The flexible tube is stabilized by a gauge ring and an anchor weight.

Mounting on a floating roof tank by the guide ring method

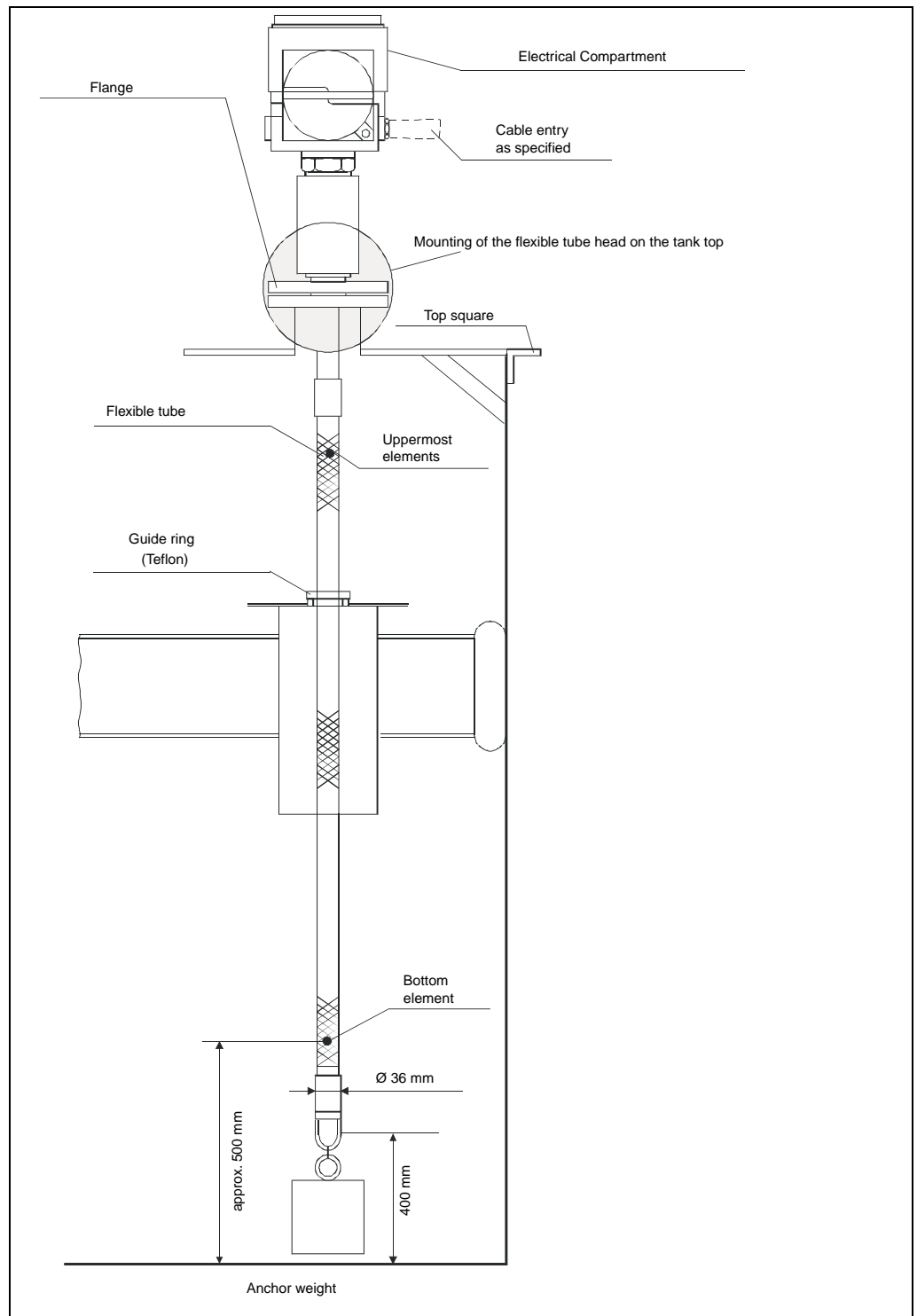



Note!

Note!

If the tank bottom is equipped with a heating coil, then increase the distance between flexible tube and the tank bottom accordingly.

The installation procedure comprises the following steps:

- 1) Set the guide ring to the floating roof.
- 2) Install a gasket and lower the flexible tube into the nozzle on the tank top.



Caution!

Caution!

The flexible tube must be lowered carefully to prevent damage by touching the nozzle.

- 3) Rotate the Prothermo NMT 535 for the most convenient cabling position.
- 4) Tighten the tensioning wire between the lower end of the flexible tube and the anchor weight. Wind the tensioning wire two rounds to the hitch and wrap a commercial wire around it.



Note!

Note!

Make sure that the anchor weight is hanging steadily about 10...15 mm above the tank bottom. The exact distance depends on the tank height and the type of liquid.

- 5) Fix the mounting flange of the Prothermo NMT 535 to the nozzle on the tank top by bolts.

4. Wiring

4.1 Required Cabled Ground and Cable

The following table shows the cable ground and cable that are required for the installation of the Prothermo NMT 535.

Wiring	Cable gland	Cable
NMT 535-> NMS53x	G(PF)1/2" NPT1/2" PG16 M20 not selectable with TIIS approval	Screened twisted pair (cable sheath 8...12 mm) or steel armored wire (more than 24AWG).

If you use an unsecured wire, then equip it with a conduit pipe.



Caution!

Do not connect "+" and "-" in reverse.

4.2 Wiring Procedure

- 1) Connect the cable from the Proservo NMS 53x to the terminal in the terminal box. We recommend a crimped connection to the terminal block.
- 2) Connect the screen of the cable to "FG" (the silver part on the printed circuit board beneath the terminal block).
- 3) When the wiring procedure is finished, close the terminal box cover tight.
- 4) Hook the lock (shroud) thoroughly while cabling, check the cable drawing of the terminal box cover and electric box cover supplied by Sakura Endress.

Tighten the cable ground.



Caution!

During cabling, thoroughly, check the cable drawing supplied by Endress+Hauser.

Electrical connection from the Prothermo NMT 535 to the Proservo NMT 53x

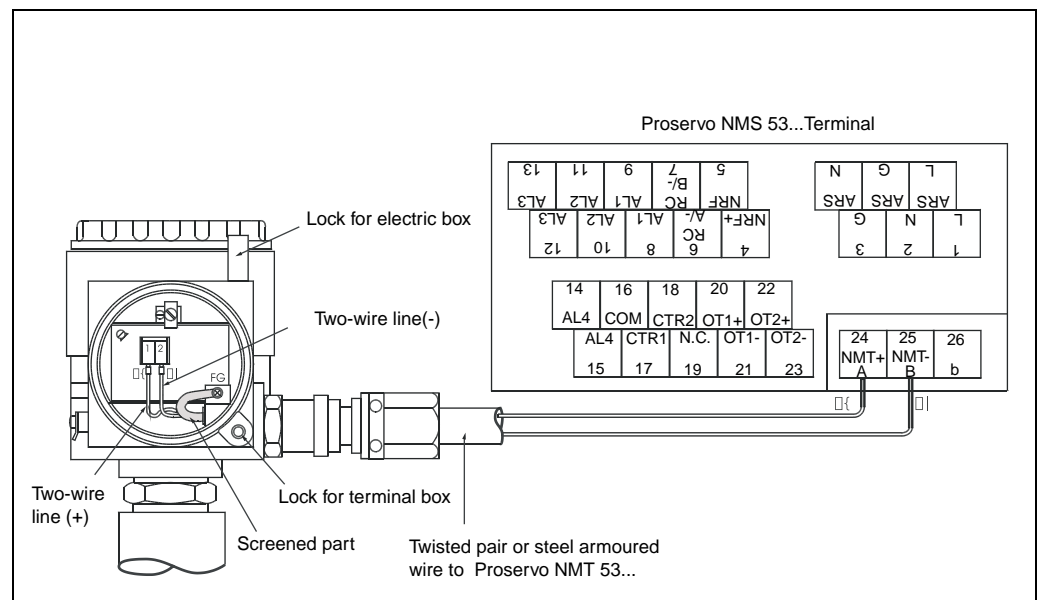

5. Operation

5.1 Operating on Matrix While Connected to the Proservo NMS 53x

When a Prothermo NMT 535 is connected to a Proservo NMS 53x, information on temperature within the tank can be displayed on the Proservo NMS 53x. This procedure requires a special matrix operation on the Proservo NMS 53x, as described in the following sections.

5.1.1 Display and Operating Elements

5.1.1.1 Display

The Proservo NMS 53x has an illuminated LCD that consists of two lines with 16 characters each. During normal operation, it shows the level, the temperature, and the status of the device on the "HOME" position. The display of the HOME position will be explained in Sec.....

Besides "HOME" position, the Proservo NMS is able to display other data and program various parameters with three optical keys. Please refer to Sec..... description of the Programming Matrix for the definition of each displays.

5.1.1.2 Operating elements



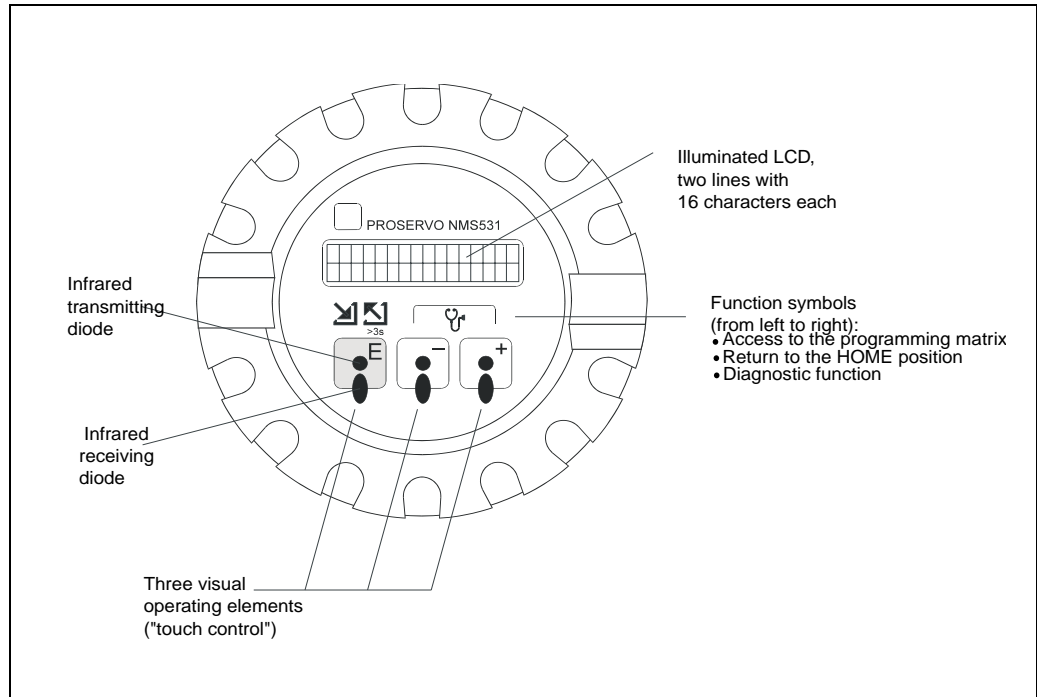

The proservo NMS 53x is operated by three optical operating elements, namely the keys +, -, and E. They are actuated by finger touch ("Touch Control") through the protective glass on the front panel; therefore, they do not accept any spontaneous and accidental input, such as direct sunlight, snow flakes, and shadow. The software and hardware installed in the Proservo NMSA 53x rule out any malfunction that may be caused in these conditions. Even in explosive hazardous areas, the explosion-proof housing of the touch control ensures safe access to the data.

Display and operating elements



5.1.2 Functions of the Operating Elements

Establishing the operation parameter of NMS is initiated at the programming matrix. The programming matrix consist of:

Key	Functions
	<ul style="list-style-type: none"> • Access to the programming matrix (touching  for more than 3 sec.) • Return to the HOME position (touching  for more than 3 sec.) • Moving horizontally within a function group to select functions. • Saving parameters, set values, or access code.
 	<ul style="list-style-type: none"> • Moving vertically to select function groups. • Selecting or setting parameters. • Setting access code.



Note!

- The LCD will return to the HOME position if no key is touched for more than 10 min.
- Digits are incremented or decremented by + or -, respectively. If you touch + or - continuously, then the minimum digit will change first. After one cycle of the minimum, the second minimum will change. After one cycle of the second follows the third minimum, and so on. If you take your finger from the touch control, then the procedure will start again from the minimum digit. (Analogy of mechanical counter)

Selecting matrix groups, function groups, and function within the programming matrix

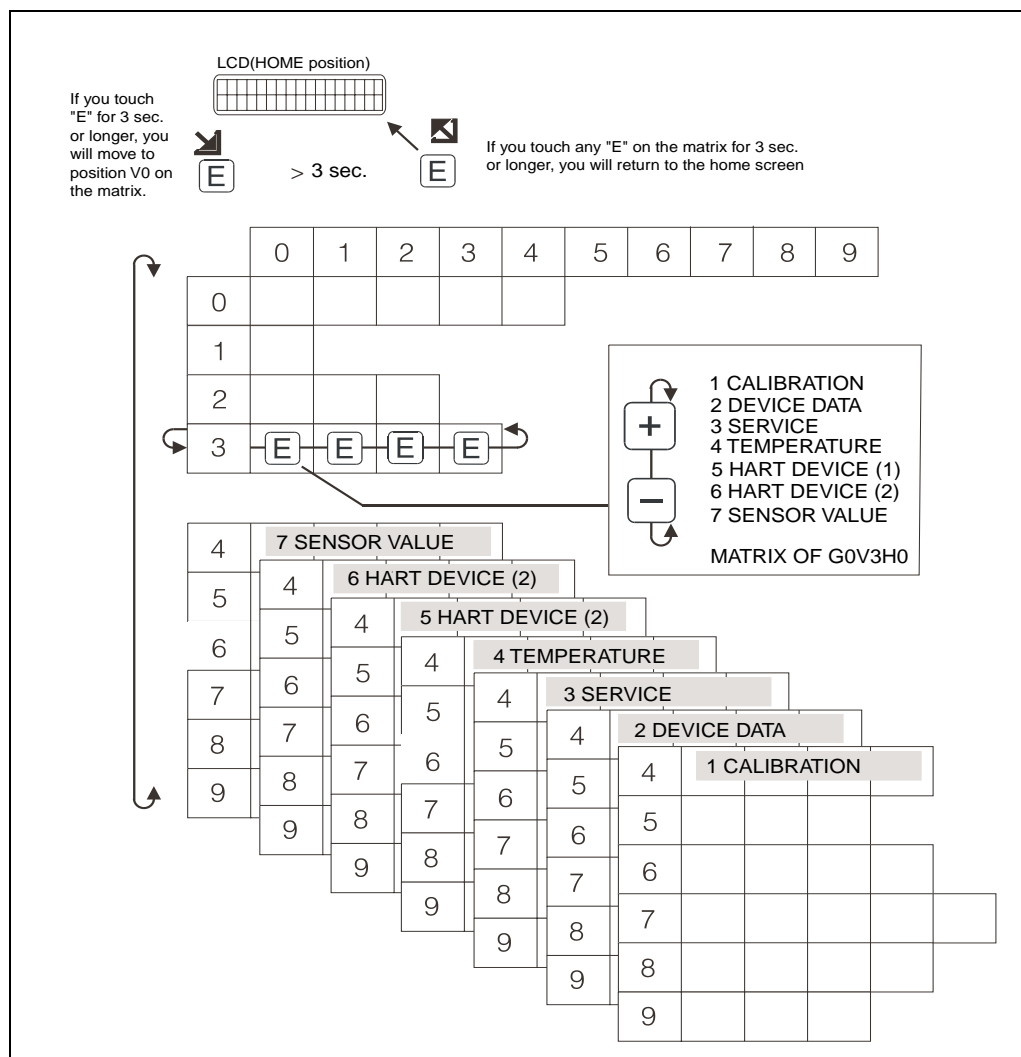

5.1.3 HOME position

After switching on the power supply, the LCD first shows the current data on the HOME position. Its pattern is represented below, where # denotes a digit or minus sign, and \square denotes a letter or hyphen.

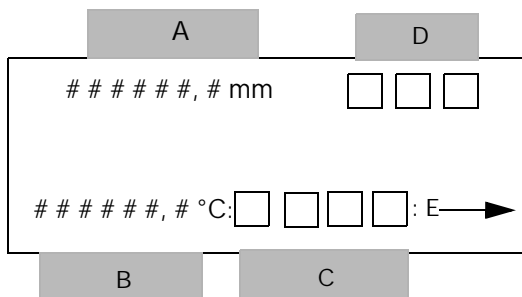

The letter A,B,C and D stand for the areas where information on measured values and status of the device is displayed:

Area	Information
A	Current level
B	Current temperature
C	Gauge status
D	Displacer status

5.1.4 Access Code



The purpose of the access code is to secure the installed data. There are three security level for functions of the Proservo NMS 53x. The following table shows the corresponding access code.

Security level		Access code
0	-	None
1	for operator	50
2	for engineer	51

The higher levels include the lower ones, e.g. if access code 50 is specified for a function, then code 51 also enables editing. A function that requires access code 51, on the contrary cannot be edited by code 50.

Display of data or set values for security levels 0 and 1 is available without code. However, a display of security level 2 is not available without presetting of the access code 51.

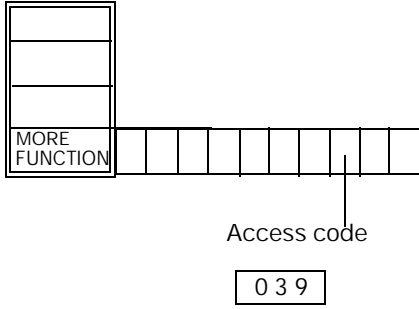
Setting an access code

Item	Procedure	Remarks
<p>Static matrix</p>  <p>The diagram shows a static matrix with a 'MORE FUNCTION' button on the left. To its right is a row of 10 small rectangular cells. Below this row is a larger rectangular display area containing the digits '039'. A line points from the label 'Access code' to this display area.</p>	<ol style="list-style-type: none"> At the static matrix "MORE FUNCTION" select G0V3H9 "ACCESS CODE". The default value is "0" keep touching "+" until you get to "50" or "51". The first digit increases to 9, then the second digit increases. Stop touching "+" once you reach "50". "50" is blinking. Gently touch "+" again to increase the second digit from 0 to 1. Now you have "51" Here touch "E", "EDITING ENABLE" will be displayed. 	 <ol style="list-style-type: none"> When you touch "E" While displaying an Access code except 0, 50 or 51 "EDITING ENABLE" will appear. If access code has not been selected before performing any setting, the screen will automatically change to show "EDITING ENABLED". Select "50" or "51" according to the matrix table.

5.1.5 Description of the Programming Matrix

The rows 0...3 of the programming matrix are called the static matrix. Its function is to display or allow programming of mainly measured values (primary variables) and basic operation of the Proservo NMS 53x

The rows 4...9 exist on six different "pages" called the dynamic matrix. These matrix groups are labeled as follows;

STATIC MATRIX

- STATIC (V0-V3) or DYNAMIC MATRIX (V0 - V3)
- CALIBRATION (G1V4 - G1V9)
- DEVICE DATA (G2V4 - G2V9)
- SERVICE (G3V4 - G3V9)
- TEMPERATURE (G4V - G4V9)
- HART DEVICE (1) (G5V4 - G5V9)
- HART DEVICE (2)
 SENSOR VALUE

- * G = Group
- * V = Vertical
- * H = Horizontal

Their function to display or allow programming of parameters that are required for operation and commissioning of the Proservo NMS 53x and/or the Prothermo NMT 535. As already indicated in "Selecting matrix groups, function groups, and functions within the programming matrix", the dynamic matrix is selected at position G0V3H0 "MATRIX OF" of the static matrix

The individual functions of the matrix groups are described on the following pages.

The index number in the last column denotes matrix group (0 for the static matrix, 1...6 for the dynamic matrix), vertical position (or "FUNCTION GROUP"), and horizontal position (or "ITEM") of the function.

5.2 Setting the Matrix on a Proservo NMS 53x

To display Prothermo NMT 535 data on the Proservo NMS 53x screen, perform the following procedure.

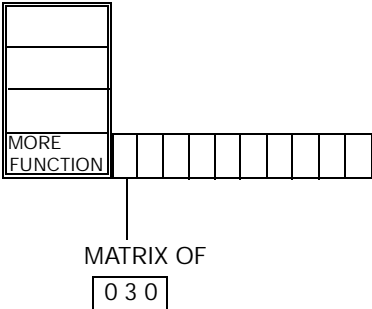
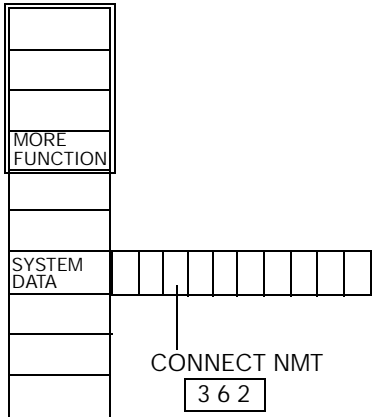
Item	Procedure	Remarks
<p>Static matrix</p>  <p>Matrix group: SERVICE</p> 	<ol style="list-style-type: none"> At the static matrix "MORE FUNCTION", call G0V3H0 "MATRIX OF", then select "SERVICE". Call up "CONNECTION NMT" on Dynamic matrix G3V6H2. Use "+" and "-" keys to display "AVERAGE", and touch "E" to return to "MORE FUNCTION". Touch "E" to return to "SYSTEM DATA". Keep touching "E" to return to "MORE FUNCTION". Call up "MATRIX OF" on Static matrix G0V3H0. From the six matrix groups on Proservo NMS 53x, select "TEMPERATURE". The average liquid temperature is shown on Dynamic matrix G4V4H0. The temperature at each point can be displayed on Dynamic matrixes G4V5H0 through G4VSH9. 	<ul style="list-style-type: none"> Set the access code to "51" The average temoera- ture will also be displayed at "LIQUID TEMP". on Static Matrix G0V1H0.



Caution!



Refer to the operating manual for Proservo NMS 53x, when setting the matrix on Proservo NMS 53x.

5.3 Programming Matrix

This section shows the complete programming matrix of Proservo NMS 53x (necessary for NMT 535 only). Each matrix group appears on a separate page. The functions are described in the following chart:

MATRIX GROUP		
V	H	Horizontal position: 0...9
Vertical position 0...3: Static or 4...9: Dynamic	FUNCTION GROUP	Item Default value Set / Select / Display (Access code)

The access code is additionally indicated by tint of the label cell.

Tint	Access Code
	None
	50
	51



Caution!

This section shows only the Proservo NMS 53x programming matrix which is needed to operate the Prothermo NMT 535.

NMS53x Programming Matrix (Static Matrix)

GROUP MESSAGE	V \ H	0	1	2	3	4	5	6	7	8	9
		MEASURED VALUE 1	0	16000.00 mm MEASURED LEVEL Display	0.0 mm ULLAGE LEVEL Display	0.0 mm UPPER INTERF. LEV Display	0.0 mm MIDD. INTERF. LEV Display	0.0 mm BOTTOM LEVEL Display	1.000 g/ml UPPER DENSITY 0.000 - 3.000 Display/Set (50)	1.000 g/ml MIDDLE DENSITY 0.000 - 3.000 Display/Set (50)	1.000 g/ml DENSITY BOTTOM 0.000 - 3.000 Display/Set (50)
MEASURED VALUE 2	1	0.0°C LIQUID TEMP. Display	DEV(1) Display	DEV(2) Display	0.0°C GAS TEMPERATURE Display				0 mm ZERO POINT Display	16000.0 mm SPAN Display	mm LENGTH UNIT Display
OPERATION	2	STOP OPERATION 16000 See below operation commands Select (50)	STOP OPERATING STATUS See below status table Display	UNBALANCED BALANCING STATUS Display		LEVEL OPERAT.BY NRF Display	LEVEL OPERAT.BY HOST Display			411 DEVICE ID Display	8424 SOFTWARE VERSION Display
MORE FUNCTION	3	CALIBRATION MATRIX OF Select			98 627 8:21:00 CALENDER Current data Display	NO ALARM ALARM CONTACT 0 Current data Display	NO ALARM LA 0 0 0 0 Current data Display	NO ERROR DIAGNOSTIC CO 0 Current data Display	MPU:START ACT 98 627 752 0 0 Current data Display		0 ACCESS CODE 0, 50, 51, 777 Set

Static Matrix

NMS53x Programming Matrix (Dynamic Matrix, Service: G3)

GROUP MESSAGE	H V	0	1	2	3	4	5	6	7	8	9
MEAS.WIRE & DRUM	4	300.00 mm WIRE DRUM CIRC. 0 - 999.9 Set (51)	1.4 g / 10m WIRE WEIGHT 0 - 999.9 Set (51)	255.0 g DISPLACER WEIGH 0 - 999.9 Set (51)	145.0 mL DISPLACER VOLUME 0 - 999.9 Set (51)	60 mL BALANCE VOLUME 0 - 999.9 Set (51)	1.0 mL VOLUME TOLERANCE 0 - 99.9 Set (51)		20 X 100 mS DELAY 0 - 99 Set (51)	0.00 mm/m DRUM CORRECTION 0 - 99.00 Set (51)	0 count DISPL.HUNT.COUNT 0 - 99 Set (51)
GAUGE DATA	5			OFF NON HYSTER. MOD ON Select (51)	OFF HI. ACCURACY MOD ON Select (51)	0 s BI. ACCR. OPE. TIME 0 - 600 Set (51)	50 mm HI. ACC. DISP. UP 0 - 300 Set (51)	Current Data GAUGE TEMP. Display (51)			
SYSTEM DATA	6	LOCAL : MASTER SENSOR DATA REMOVED COM. ON SOFTWARE = 04.20 HARDWARE=TCB04 GEAR 1:36 NOT OVERSPILL	OFF CONNECTION NRF CONTACT 1 CONTACT 2 Select (51)	OFF CONNECTION NMT SPOT TEMP. AVERAGE TEMP. Select (51)							OFF SOFT RESET ON Select (51)
SERVICE	7	0.0 g MEASURED WEIGHT Display	OFF RELE. OVER TENS ON Select (51)	OFF DRUM SETTING ON Select (51)	OFF WEIGHT CALIBR. ON Select (51)					70 mm DISPL. REFERENCE Set (51)	0.0 g ZERO ADJ. WEIGHT Set (51)
SENSOR VALUE	8	Sa=21000:A=21000 Sb=11000:B=11000 Display (51)									
SENSOR DATA	9					0 0 0.0g WT.COUNT CAL A Display (51)	0 0 0.0g WT.COUNT CAL B Display (51)				

Service Matrix

NMS53x Programming Matrix (Dynamic Matrix, Temperature: G4)

GROUP MESSAGE	H V	0	1	2	3	4	5	6	7	8	9
TEMPERATURE DATA	4	xx °C LIQUID TEMP. Current data Display (51)	zz °C GAS TEMPERATURE Current data Display (51)	aaaa.a mm MEASURED LEVEL Current data Display (51)	VH00 LEV.DATA SELECT VH08 Select (51)				0.0 °C REFERENCE ZERO Current data Display (51)	152.5°C REFERENCE JPT15 Current data Display (51)	150.0 °C REFERENCE 150 Current data Display (51)
ELEMENT TEMP.	5	aa.a °C TEMP. NO.1 Current data Display (51)	bb.b °C TEMP. NO.2 Current data Display (51)	cc.c °C TEMP. NO.3 Current data Display (51)	dd.d °C TEMP. NO.4 Current data Display (51)	ee.e °C TEMP. NO.5 Current data Display (51)	ff.f °C TEMP. NO.6 Current data Display (51)	gg.g °C TEMP. NO.7 Current data Display (51)	hh.h °C TEMP. NO.8 Current data Display (51)	ii.i °C TEMP. NO.9 Current data Display (51)	jj.j °C TEMP. NO.10 Current data Display (51)
ELEMENT POSITION	6	xxx.x mm ELEM.1 POSITION Current data Display (51)	xxx.x mm ELEM.2 POSITION Current data Display (51)	xxx.x mm ELEM.3 POSITION Current data Display (51)	xxx.x mm ELEM.4 POSITION Current data Display (51)	xxx.x mm ELEM.5 POSITION Current data Display (51)	xxx.x mm ELEM.6 POSITION Current data Display (51)	xxx.x mm ELEM.7 POSITION Current data Display (51)	xxx.x mm ELEM.8 POSITION Current data Display (51)	xxx.x mm ELEM.9 POSITION Current data Display (51)	xxx.x mm ELEM.10 POSITION Current data Display (51)
NMT ADJUSTMENT	7	0 SELECT POINT 0 - 15 Selectable SELECT POINT + 1 = ELEMENT No. Set (51)	0.0 °C ZERO ADJUST Set (51)	1.000 GAIN ADJUST Set (51)	xx.x °C ELEMENT TEMP Current data Display (51)	xxx.x mm ELEMENT POSITION Current data Display (51)				2 AVERAGE TIME Set (51)	530 ACCESS CODE
SET DATA NMT	8	0 DIAGNOSTIC Display (51)		16 TOTAL NO.ELEMENT 2 - 16 Set (51)	5 PREAMBLE NUMBER 1 - 16 Set (51)		EQUAL KIND OF INTERVAL UNEQUAL Select (51)	500.0 mm BOTTOM POINT 0.0 mm to 500.0 mm valuable Set (51)	2000.0 mm ELEMENT INTERVAL Set (51)	-49.5 °C TEMP.ELEM.SHORT Display (51)	359.0 °C TEMP.ELEM. OPEN Display (51)
DEVICE DATA NMT	9	825123 INSTRUMENT CODE Display (51)	LAST DIAGNOSTIC Display (51)	OUTPUT AT ERROR Select (51)	OFF CUSTODY TRANSFER ON Display (51)	2 POLLING ADDRESS Display (51)	17 MANUFACTURE ID Display (51)	5 SOFTWARE VERSION Display (51)	2 HARDWARE VERSION Display (51)	ON BELOW BOT. POINT OFF Set (51)	183 DEVICE TYPE CODE 181 Display (51)

Temperature Matrix

Adjustment Matrix

NMS53x Programming Matrix (Dynamic Matrix, ADJ. SENSOR: G7)

GROUP MESSAGE	V ^H	0	1	2	3	4	5	6	7	8	9
ADJ. SENSOR	4	ADJ. A ZERO	ADJ. A SPAN	ADJ. B ZERO	ADJ. B SPAN						
HART ERROR RATE	5	0.00% ERR. RATE NMF	0.00% ER. RATE NMT	0.00% ERR. RATE DEV(1)	0.00% ERR. RATE DEV(2)						
UNIT	6	mm LEV. UNIT (HOST)	°C TEMP. UNIT (HOST)	g/ml DEN. UNIT (HOST)			mm LEV. UNIT	°C TEMP. UNIT	g/ml DEN. UNIT		
HART LINE	7	TERMINAL PORT B NMT TERMINAL PORT A Select (777)	TERMINAL PORT B HART DEVICE (1) TERMINAL PORT A Select (777)	TERMINAL PORT B HART DEVICE (2) TERMINAL PORT A Select (777)							
INTERFACE ADJUST	8	0.3 mL VOL.TOL.FOR I/F 0 - 99.9 mL Set (51)	150 BRAKE RATE 0 - 255 Set (51)	15 BALANCE COUNT 0 - 255 Set (51)	0.0 mm IF1 OFFSET 0 - 9999.9 mm Set (51)	0.0 mm IF2 OFFSET 0 - 9999.9 mm Set (51)					
NONE	9										

5.4 Description of the Programming Matrix

The programming matrix of the Prothermo NMT535 is mainly designed to configure from the Proservo NIMS 53x. Commissioning from the Tank side monitor NRF 590 or any other HART device may perform differently. Please refer to each designated operation manual for detailed information. For detailed information on touch control and programming matrix, refer to the operating manual of the Proservo NIMS 53x.

Matrix group	Function group	Item	Access code	Short description	Default value	Set Select Display	Possible settings, selections, or displays	Index No, GVH
STATIC MATRIX (This word is not shown)	MEASURED VALUE 2	LIQUID TEMP.	0	If a temperature bulb is connected, then this position shows the measured liquid temperature. Otherwise the LCD will be blank.	0.0 °C	Display	-49.9 ... 249.9 °C	010
		GAS TEMPERATURE	0	If a temperature bulb is connected, then this position shows the measured gas temperature.	0.0 °C	Display	-49.9 ... 249.9 °C	013
	MORE FUNCTION	MATRIX OF	0	Selection of the dynamic matrix of the programming matrix	CALIBRATION	Select	CALIBRATION DEVICE DATA SERVICE TEMPERATURE HART DEVICE (1) HART DEVICE (2) ADJ. SENSOR	030
		(Calendar)	0	Calendar and clock without daylight saving system. NOT TRANSFERRED BY RACKBUS.	Japanese local time	Display	e.g. 1 410 19:10:41 Year Month Day HH:MM:SS	033
		DIAGNOSTIC CO	0	Self diagnosis at the moment		Display	Error message (refer to attached table)	036
		(Erroneous Message)	0	Previous alarm with message. Only the last alarm code is transmitted by Rackbus.	(Erroneous Date)	Display	Error message (refer to attached table)	037
		ACCESS CODE	0	Access code for programming (see Sec. 10.4)	0	Set	0 ... 9999	039
SERVICE	SYSTEM DATA	CONNECTION NMT	51	Connection of the Prothermo NMT535	OFF	Select	OFF SPOT (three wire RTD input) Average (NMT535)	362

Matrix group	Function group	Item	Access code	Short description	Default vaule	Set Select Display	Possible settings, selections, or displays	Index No, GVH
TEMPERATURE Note! The whole matrix is available when NMT is connected and SPOT or AVERAGE temperature element is selected.	TEMPERATURE DATA	LIQUID TEMP.	51	Current average liquid temperature.		Display	-49.9 ... 249.9 °C	440
		GAS TEMPERATURE	51	Current average gas temperature.		Display	-49.9 ... 249.9 °C	441
		MEASURED LEVEL	51	Level from the Proservo. The level data are used for the averaging of liquid and gas temperatures.		Display	0.0 ... 99999 mm	442
		LEV. DATA SELECT	51	Possible to select a measured level data from matrix pos. GVH=000 (displacer position), or GVH=008 (level data after balanced).	VH00	Select	VH00 VH08	443
		REFERENCE ZERO	51	Display of reference resistance on printed circuit board that corresponds to 0 °C.	0.0 °C	Display		447
		REFERENCE JPT150	51	Display of reference resistance on printed circuit board that corresponds to JPT 150 °C.	152.5 °C	Display		448
		REFERENCE 150	51	Display of reference resistance on printed circuit board that corresponds to 150 °C.	150.0 °C	Display		449
	ELEMENT TEMP. Note! For elements with numbers beyond the value set at GVH=482, the LCD will show 358.0 °C	TEMP NO. 1	51	Temperature of element No. 1 (deepest point)		Display	-49.9 ... 249.9 °C	450
		TEMP NO. 2	51	Temperature of element No. 2		Display	-49.9 ... 249.9 °C	451
		TEMP NO. 3	51	Temperature of element No. 3		Display	-49.9 ... 249.9 °C	452
		TEMP NO. 4	51	Temperature of element No. 4		Display	-49.9 ... 249.9 °C	453
		TEMP NO. 5	51	Temperature of element No. 5		Display	-49.9 ... 249.9 °C	454
		TEMP NO. 6	51	Temperature of element No. 6		Display	-49.9 ... 249.9 °C	455
		TEMP NO. 7	51	Temperature of element No. 7		Display	-49.9 ... 249.9 °C	456
		TEMP NO. 8	51	Temperature of element No. 8		Display	-49.9 ... 249.9 °C	457
		TEMP NO. 9	51	Temperature of element No. 9		Display	-49.9 ... 249.9 °C	458
		TEMP NO. 10	51	Temperature of element No. 10		Display	-49.9 ... 249.9 °C	459

Matrix group	Function group	Item	Access code	Short description	Default vaule	Set Select Display	Possible settings, selections, or displays	Index No, GVH
TEMPERATURE Note! The whole matrix is available when NMT is connected and SPOT or AVERAGE temperature element is selected.	ELEMENT POSITION Note! The LCD shows the element position measured from the tank bottom (for previously set elements only).	ELEM. 1 POSITION	51	Position of temperature element No. 1 (deepest point), namely Bottom Element.	500mm	Display	0 ... 99999 mm	460
		ELEM. 2 POSITON	51	Position of temperature element No.2	2500mm	Display	0 ... 99999 mm	461
		ELEM. 3 POSITON	51	Position of temperature element No.3	4500mm	Display	0 ... 99999 mm	462
		ELEM. 4 POSITON	51	Position of temperature element No.4	6500mm	Display	0 ... 99999 mm	463
		ELEM. 5 POSITON	51	Position of temperature element No.5	8500mm	Display	0 ... 99999 mm	464
		ELEM. 6 POSITON	51	Position of temperature element No.6	10500mm	Display	0 ... 99999 mm	465
		ELEM. 7 POSITON	51	Position of temperature element No.7	12500mm	Display	0 ... 99999 mm	466
		ELEM. 8 POSITON	51	Position of temperature element No.8	14500mm	Display	0 ... 99999 mm	467
		ELEM. 9 POSITON	51	Position of temperature element No.9	16500mm	Display	0 ... 99999 mm	468
		ELEM. 10 POSITION	51	Position of temperature element No.10	18500mm	Display	0 ... 99999 mm	469
	NMT ADJUSTMENT	SELECT POINT	51	Element number selection for reading element temperature and position from element No. 11 to No. 16.	0	Display	0 (element No.1) 10 (element No.11)	470
		ZERO ADJUSTMENT	51	Zero adjustment		Set	-20.0 ... 20.0 °C	471
		ELEMENT TEMP.	51	Element temperature selected at "SELECT POINT"		Display	-49.9 ... 249.9 °C	473
		ELEMENT POSITION	51	Element position selected at "SELECT POINT"		Display	0 ... 99999 mm	474
		AVERAGING	51	Sampling coefficient for averaging of data. If there is a high degree of instability due to noise or other factors, increase ist value.	2	Set	1 ... 10	478

Matrix group	Function group	Item	Access code	Short description	Default vaule	Set Select Display	Possible settings, selections, or displays	Index No, GVH
TEMPERATURE Note! The whole matrix is available when NMT is connected and SPOT or AVERAGE temperature element is selected.	NMT SET DATA	DIAGNOSTIC CODE	51	Display of current diagnostic code.	0	Display	0 ... 255	480
		TOTAL NO. ELEMENT	51	The total number of elements that are mounted in the flexible tube. This number is determined in accordance with the specifications provided when the order of the device is placed.	16	Set	a ... A HEX	482
		PREAMBLE NUMBER	51	Display of preambles for HART® protocol.	5	Display	2 ... 14 HEX	483
		KIND OF INTERVAL	51	Temperature element intervals. - Equal intervals: 0 - Unequal intervals: 1 If 1 is chosen, then set the element position on matrix from GVH=460 to GVH=469.	0	Set	0 or 1	485
		BOTTOM POINT	51	Height of bottom point. Only available when equal intervals are selected.	500mm	Set	0.0 ... 99999.9 mm	486
		ELEMENT INTERVAL	51	Interval between temperature elements. Only available when equal intervals are selected.	2000mm	Set	0.0 99999.9 mm	487
		TEM. AT SHORT ELE.	51	Temperature indication when element is shorted. This value is sent to the Proservo only when the error output is "ON" at GVH=492. When the error output is "OFF", the average temperature is sent to the Proservo.	-49.5 °C	Set		488
TEM. AT OPEN ELE.	51	Temperature indication when element is opened. This value is sent to the Proservo only when the error output is "ON" at GVH=492. When the error output is "OFF", the average temperature is sent to the Proservo.	359.0 °C	Set		489		

Matrix group	Function group	Item	Access code	Short description	Default value	Set Select Display	Possible settings, selections, or displays	Index No, GVH
TEMPERATURE Note! The whole matrix is available when NMT is connected and SPOT or AVERAGE temperature element is selected.	NMT DEVICE DATA	INSTRUMENT CODE	51	Display of the hardware unit number		Display		490
		LAST DIAGNOSTIC	51	Display of the last error message. If there was no error, then the LCD will be blank.		Display		491
		OUTPUT AT ERROR	51	Selection of output and indication in case of short circuit or open circuit elements at GVH=488 or 498	1	Sselect	0: OFF 1: ON	492
		CUSODY TRANSFER	51	Custody transfer mode. If this mode is switched on, then the LCD will show on.	OFF	Sselect	OFF ON	493
		POLLING ADDRESS	51	Assignment of an address to Prothermo NMT535 when this and other HART® devices are multi-dropped on the HART® communication line. Polling address 2 is fixed by Proservo firmware.	2	Set	1 ... F (Total 16 address can be set.)	494
		MANUFACTURER ID	51	Identification number of the manufacturer (17 for Endress+Hauser).	17	Display		495
		SOFTWARE VERSION	51	Software version of the Prothermo NMT535.	5.0	Display	4.0 or higher	496
		HARDWARE VERSION	51	Hardware version of the Prothermo NMT535.	1.4	Display	1.4 or higher	497
		DEVICE TYPE CODE	51	Display of the device type code (181 for the Prothermo NMT535)	181	Display		499
ADJ. SENSOR Note! The ports selections have to be done, when the Proservo has FFX dflal	UNIT	TEMP. UNIT (HOST)	51	Able to switch displaying unit for remote receiving host system.	°C	Select	°C, °F, °R, °K	761
		TEMP. UNIT	51	Able to switch displaying unit for NMS & NMS connected local HART displaying unit.	°C	Select	°C, °F, °R, °K	766
	HART LINE	NMT	777	Assignment of Prothermo NMT535 with IS HART or Non-IS HART connection. - TERMINAL PORT B: Non-IS HART connection - TERMINAL PORT A: IS HART connection	TERMINAL PORT B	Set	TERMINAL PORT B TERMINAL PORT A	770

6. Error Codes

If an error has occurred in the Prothermo NMT 535, then the Proservo NMS 53x will display an error message and also send error information to the receiver.

6.1 Short Circuit or Break

After a short circuit or break in the elements or the wiring, the Prothermo NMT 535 display an extreme temperature such as

-49.5°C (-57.1°F)... default for short circuit)

or

359.0°C (678.2°F)... default for break

on the HOME position of the Proservo NMS53x and transferring it to a remote system for convenient monitoring function for the faulty condition. These temperatures will only be displayed while the element at fault is selected.

If you select a faultless element, then the LCD will show the correct average temperature. Setting is possible at positions G0V8H8/9 and G0V9H2 of the programming matrix.

6.2 Communication Error

After a communication error between the Prothermo NMT 535 and the Proservo NMS 53x (HART® communication error), the Proservo NMS 53x will display 395.5°C (743.9°C) on the HOME position of the Proservo NMS 53x.

6.3 Error and Status Messages

Message	Cause	Remedy
TEMP.COM.OPEN	Common line for elements break	Check the common line for elements. Consult E+H Service for replacement of the temperature sensor.
TEMP.COM.SHORT	Common line for elements short circuit.	Check the common line for elements. Consult E+H Service for replacement of the temperature sensor
ELEM. X OPEN X = 1...16	No. X element (or line) break	Check the element. Measure the resistance by attaching a Digital Multimeter rod to the connector.(*)
ELEM. X SHORT X = 1...16	No. X element (or line) short circuit	Check the element. Measure the resistance by attaching a Digital Multimeter rod to the connector.(*)

(*) Never use an analogue-type tester, which would allow too much electric current to flow to the measuring element when determining the resistance. The current should be limited to 1 mA or less during such test.

Message	Cause	Remedy
ELEM 0 RANGE OVER	The reading of the reference resistance (0 C) on the printed circuit board is out of tolerance.	The circuit board should be replaced. Contact E+H service.
TEM BELOW RANGE	The measured temperature is below the set range.	Measure the temperature in the tank. If it is significantly different from the indicated Prothermo setting, check the temperature-element resistance.
TEM OVER RANGET	The measured temperature is above the set range.	Measure the temperature in the tank. If it is significantly different from the indicated Prothermo setting, check the temperature-element resistance.
BELOWBOT. POINT	The level data are below the lowest (bottom) element.	The reading gives only the average gas temperature.

7. Appendix

The allowable temperature range is determined by the following tolerance:

These are not equations.

There are "tolerances".

Special tolerance resistance element:

Contact us if you wish to purchase any tolerance resistance element that is not on this standard products list

Measured temperature	Tolerance	
	Ω	C
-20	± 0.24	± 0.55
-100	± 0.14	± 0.35
0	± 0.16	± 0.15
100	± 0.13	± 0.35
200	± 0.20	± 0.55
300	± 0.27	± 0.75
400	± 0.33	± 0.95
500	± 0.38	± 1.15
600	± 0.43	± 1.35
650	± 0.46	± 1.45
700	-	-
800	-	-
850	-	-

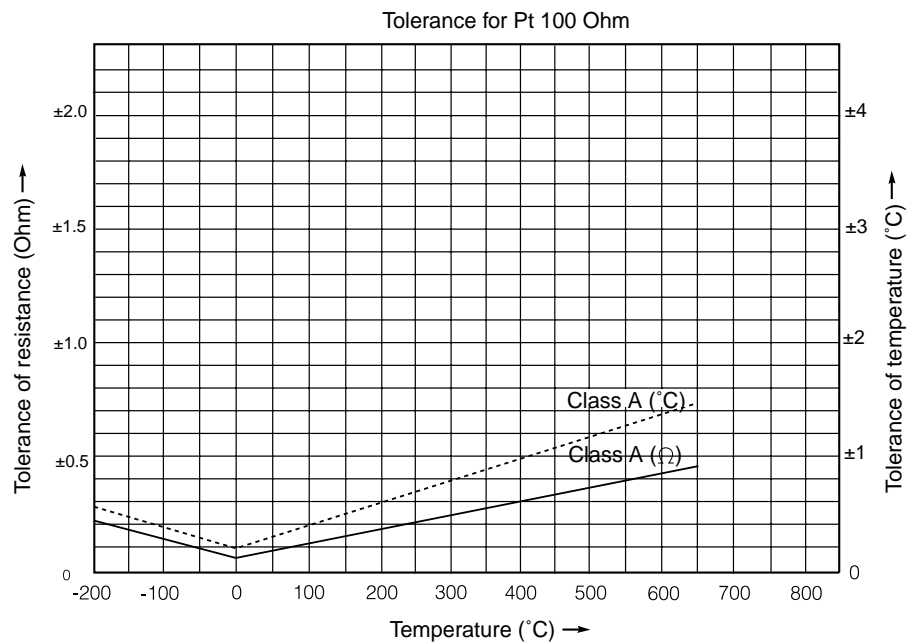

Sakura Endress Co., Ltd
862-1 Mitsukunugi,
Sakaigawamura,
Higashi-Yamanashigun,
Yamanashiken 406-0846
Japan

Phone: ++81-55-266-4964
Fax: ++81-55-266-4969
E-mail: pcm@sew.co.jp