

# Appendix of the operating manual

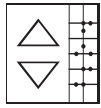
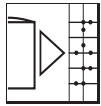
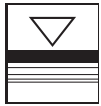
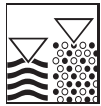

## Memo-Graph

### DP-Slave-Module \_is Pro Gate<sup>®</sup> ("profibuscoupler") V1.51 upwards

Connection of Memo-Graph to  
PROFIBUS DP via serial interface with  
\_is Pro Gate<sup>®</sup> of ifak system GmbH



---

<b>1 General</b> .....	<b>2</b>
1.1 Transportation damage ? .....	2
1.2 Complete delivery ? .....	2
1.3 Used terms .....	2
<b>2 Installation</b> .....	<b>3</b>
2.1 Requirement .....	3
2.2 Connections/terminal layout .....	3
2.3 Functionality .....	3
2.4 Termination impedance .....	3
2.5 Block diagram .....	4
<b>3 Setting up</b> .....	<b>4</b>
3.1 General.....	4
3.2 Check existence of the profibuscoupler .....	4
3.3 Settings in set up .....	5
3.4 Analogue inputs .....	6
3.5 Mathematics channels .....	6
3.6 Digital inputs / digital boards.....	7
3.6.1 Control input resp. on/off events .....	7
3.6.2 Impulse counter resp. op. time counter .....	7
3.6.3 Event + op. time counter .....	7
3.7 Combining digital channels.....	8
3.8 Relays/OC .....	8
3.9 Control of data transferred.....	9
<b>4 Data exchange</b> .....	<b>10</b>
4.1 General.....	10
4.2 Reference data .....	10
4.2.1 32-bit floating point (IEEE-754).....	11
4.2.2 Digital states .....	12
4.2.3 Status .....	12
4.2.4 Relays .....	12
4.2.5 Example .....	12
<b>5 Implementation in Simatic S7</b> .....	<b>13</b>
5.1 Network topology .....	13
5.2 Hardware configuration .....	13
5.2.1 Installation and preparation.....	13
5.2.2 Slave configuration for Memo-Graph .....	14
5.2.3 Configuration download .....	15
5.3 Specimen program .....	15
5.3.1 Address list .....	15
5.3.2 Program in function block.....	15
5.4 Monitoring.....	16
5.4.1 Variable table .....	16
5.4.2 Monitoring the slave data .....	16
5.4.3 Modify values .....	17
5.5 Status codes .....	19
5.5.1 Table .....	19
5.5.2 Example of status codes .....	19
<b>6 Troubleshooting</b> .....	<b>21</b>
<b>7 Index</b> .....	<b>22</b>

---

# 1 General

## 1.1 Transportation damage ?

Attention: Please inform both your supplier and shipping agent!

## 1.2 Complete delivery ?

- these operating instructions
- the DP-Slave-Module `_is Pro Gate` with user manual



- serial interface connecting cable for Memo-Graph
- disk with GSD-file and bitmaps

**Please inform your supplier immediately if anything is missing!**

Please take note of the following characters:

**Hint:**  Hints for better installation/operation.

**Attention:**  Ignoring this note can lead to damage of the device or faulty operation.

## 1.3 Used terms

**Profibuscoupler:** Even from now the term for `_is Pro Gate` is **profibuscoupler**.

**PROFIBUS-master:** All facilities like PLC, PC plug in cards, etc. which fulfil a PROFIBUS-master function are called **PROFIBUS-master** from now on.

---

## 2 Installation

### 2.1 Requirement

The option is only available:

- with a new CPU-board up the unit number xx 542041 (CW12/2000)
- without the "old" PROFIBUS DP option (PROFIBUS Listener) RSG10-E(F,G,H)xxx
- Memo-Graph firmware V2.50 upwards



**Hint:** The profibuscoupler has to be connected to the serial RS232-interface at the backside of Memo-Graph.



**Attention:** If the profibuscoupler is cable-connected, the serial interface at the front is not useable!

### 2.2 Connections/terminal layout

Interface RS232 (backside of Memo-Graph):

Sub-D-connector DIN 41652, jack, 9-pins



**Hint:** Leave open unused ports

Pin Memo-Graph	profibuscoupler
5	GND
2	RxD
3	TxD

Colour
green
white
brown

	profibuscoupler
RS485	3
	8
	5

Data B
Data A
GND

Power supply: 24 V DC / 100 mA

### 2.3 Functionality

The profibuscoupler is the connection of Memo-Graph to PROFIBUS DP, with the functionality of a DP-slave with cyclic services.

Supported baud rates 45,45k, 93,75k, 187,5k, 500k, 1,5M, 3M, 6M und 12MBaud.

### 2.4 Termination impedance

The profibuscoupler comes with integrated termination impedances, reside behind the front panel. Place e.g. a screw-driver in the slit between front panel and clamps and cancel the front panel carefully. Bridgeover the three opened wrap connexions with the existing plug-in jumpers. Reinstall the front panel by pressing powerfully. Please take account of the hole for the LED.

---

## 2.5 Block diagram

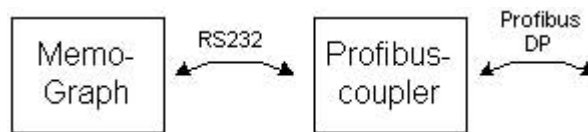

## 3 Setting up

### 3.1 General



If the function **data interface** is not available in set up, you have to make a **once-only** initialisation.

1. Turn off Memo-Graph
2. Connect the profibuscoupler at the serial RS232 interface at the rear side of Memo-Graph
3. Turn on the profibuscoupler
4. Turn on Memo-Graph

From now on, the function **data interface** is available, independent of the existence of the profibuscoupler. And now the functionality appears in the PC-software-package ReadWin®.



The existence of the profibuscoupler will only be detected while initialisation of Memo-Graph. If no profibuscoupler is detected, you can use the serial interface as usual for setting up or read out. If there is a RS485-interface available in Memo-Graph, you can use it for data exchange to PC-software.

### 3.2 Check existence of the profibuscoupler

After selection of "ext. DP-Slave-Module " on Memo-Graph under **data interface** (see next chapter) the hint "DP" in the headline appears.

The background colour gives information about the state of the data interface.

**Read** background: Problem at connection establishment. You can see detailed info under softkey "Info" (see chapter 3.9).

```
12.10.00 17:14 Analogue 1-8 DP H1A: --
```

**Green** background: Connection established successfully, communication in progress.

```
12.10.00 17:15 Analogue 1-8 DP H1A: --
```

### 3.3 Settings in set up

After power up of Memo-Graph the profibuscoupler will be initialised via RS232 (Slave-address, etc.).



If there is a change in set up which affects e.g. the ring-memory of the measured values, a reinitialisation of Memo-Graph will be carried out, i.e. a reinitialisation of the profibuscoupler.

Consequence: The profibuscoupler retires from DP-side, in order to come back a few seconds later. This produces a "Component part carrier failure" at the PLC. E.g. the Simatic S7 goes in STOP-mode and has to restarted hand controlled to RUN-mode. There is the possibility to intercept the interruption by transferring OB86 to PLC. The PLC then doesn't go in STOP-mode, only the red LED flashes for a short time and the PLC continues in RUN-mode.

These settings are only possible if the once-only initialisation is performed. And are possible also without cable-connected profibuscoupler.

Under */Miscellaneous/Extras /Data interface/Communicate with* select **ext. DP-Slave-Module**.

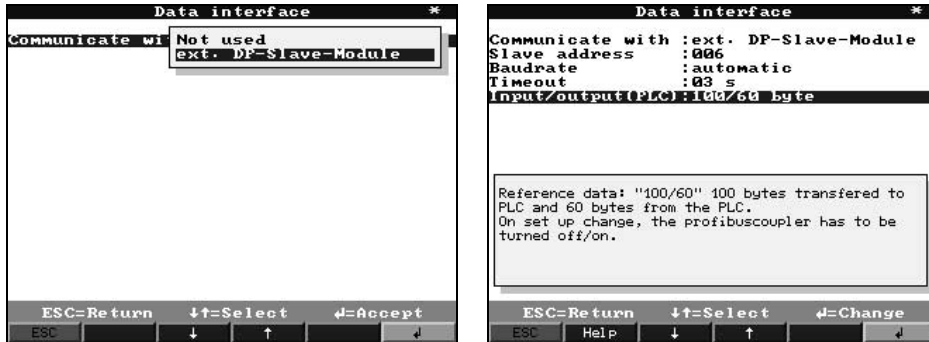

Then select slave-address, baud rate, timeout and reference data structure (see also chapter 4.2). Please select a slave-address less than 126.



Now all inputs and outputs are available, even if they don't really exist.

### 3.4 Analogue inputs

If the analogue inputs don't really exist, only one selection is possible.

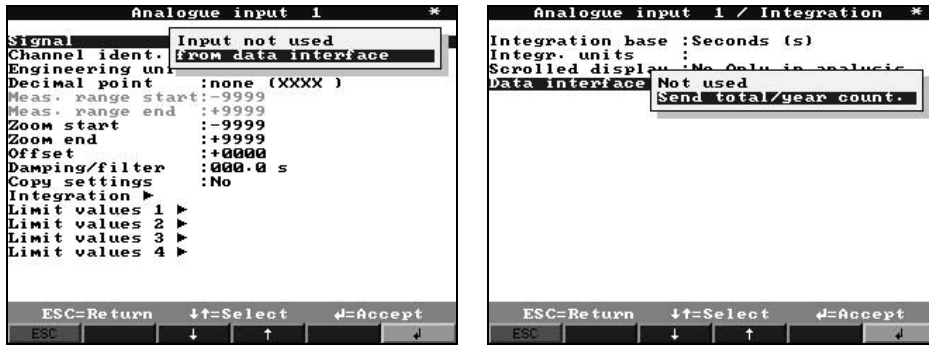

I.e. "Analogue inputs" only come from PROFIBUS-master. But it's possible to send the integrated value via data interface.

If the analogue inputs are substantial, you can choose the analogue input from the analogue board, of course.

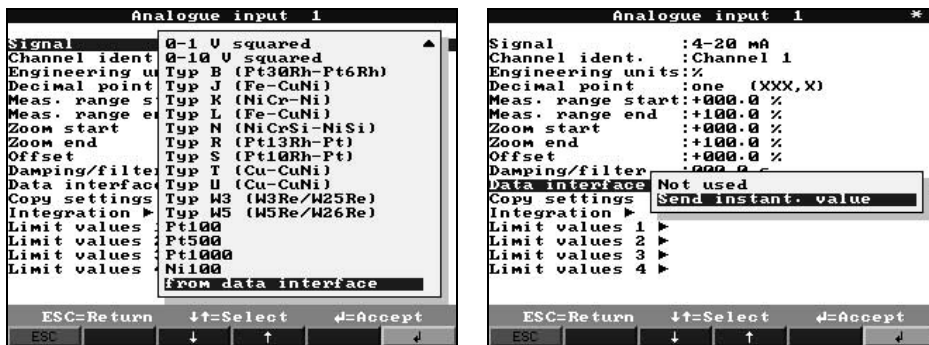

After selection of an substantial analogue input (here "4-20 mA"), you can send this value via data interface to PROFIBUS-master.

### 3.5 Mathematics channels

Mathematics channels may send via data interface to PROFIBUS-master.

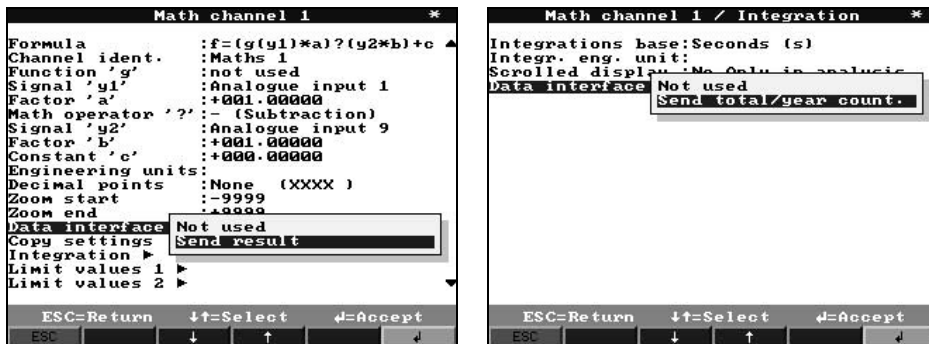

The integrated result may send via data interface to PROFIBUS-master.

### 3.6 Digital inputs / digital boards

#### 3.6.1 Control input resp. on/off events

The status can be sent to PROFIBUS-master or the digital status may be received from PROFIBUS-master.

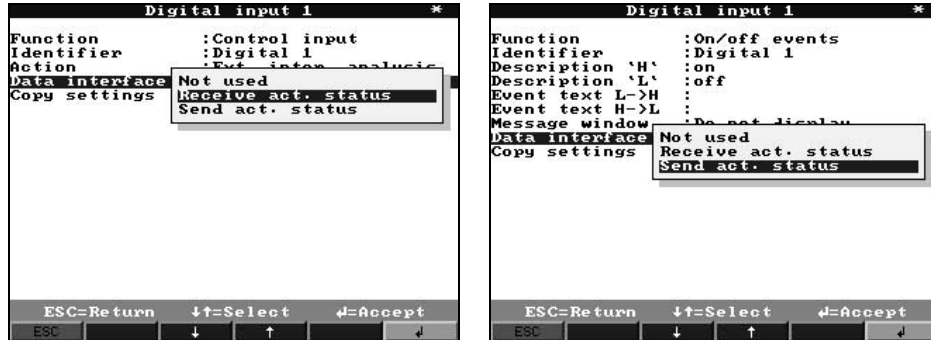

#### 3.6.2 Impulse counter resp. op. time counter

The impulses can be received from PROFIBUS-master, or the impulse counter of a substantial digital input can be sent to PROFIBUS-master.

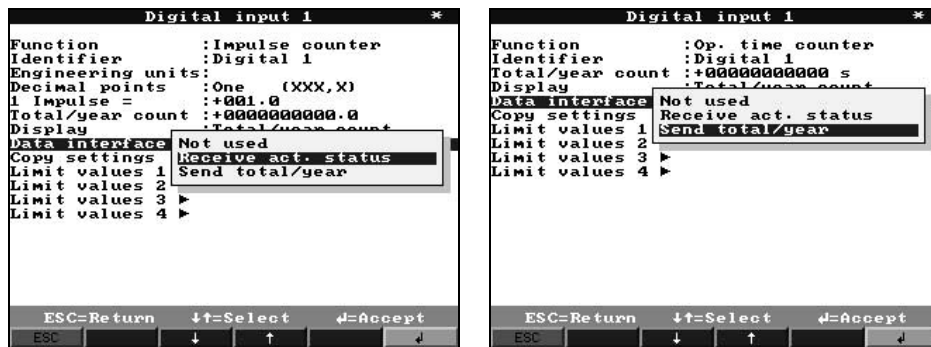

#### 3.6.3 Event + op. time counter

The total counter and the digital status can be sent to the PROFIBUS-master, or the digital status can be received from PROFIBUS-master.

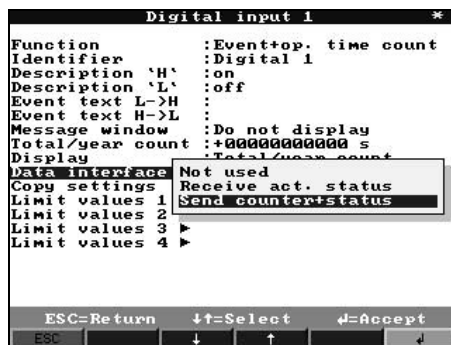



### 3.7 Combining digital channels

If the combination relates to op. time and impulse counter, the result can be sent as a total counter, with logical combination the status.

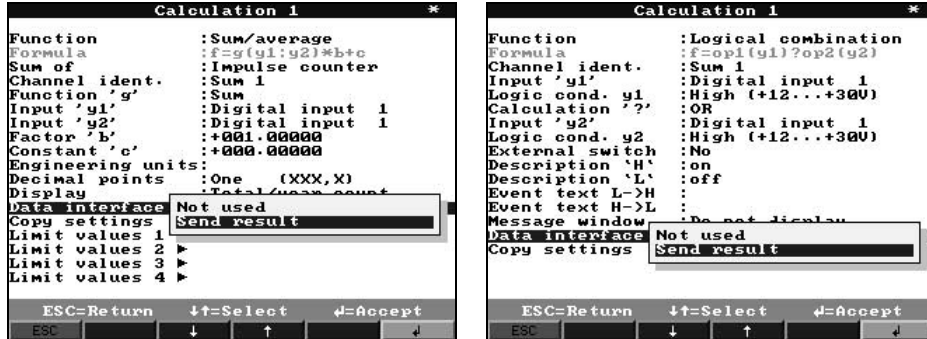

### 3.8 Relays/OC

Under /Service/Relay operation mode you can select the output of all relays conditions via data interface.

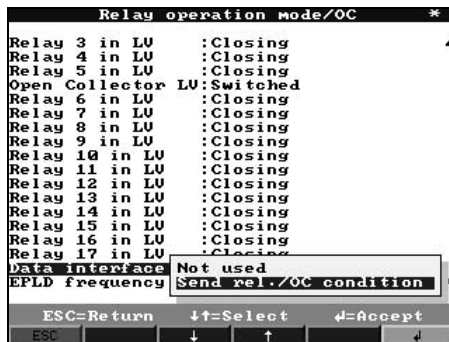

### 3.9 Control of data transferred

With softkey "Info" and then "DP-Slave" the data structure of the data interface is shown.

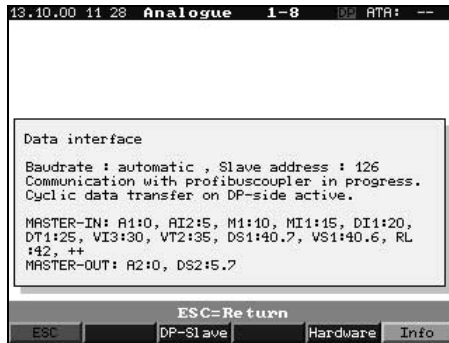

e.g. VS1:40.6 : Digital status of combination 1, offset 40 bytes, bit 6  
 AI2:5 : Analogue input 2 integrated, offset 5 bytes

Communication with profibuscoupler in progress	Memo-Graph is transmitting data to the profibuscoupler.
Communication problems with profibuscoupler	It's not possible to make a link to profibuscoupler.
Profibuscoupler connected	The profibuscoupler is substantial.
Profibuscoupler not connected	The profibuscoupler is not substantial.
Cyclic data transfer on DP-side active	Cyclic data exchange takes place between profibuscoupler and PROFIBUS-master.
No cyclic data transfer active on DP-side	<b>No</b> cyclic data exchange takes place between profibuscoupler and PROFIBUS-master.
Memo-Graph -> PROFIBUS-master <b>MASTER-IN:</b>	Structure of data, Memo-Graph sends to PROFIBUS-master:  The byte offset is shown after the colon. The bit position of an digital status is shown after the point.  <b>Ax:</b> Analogue input x <b>AIx:</b> Analogue input x integrated <b>Mx:</b> Maths channel x <b>MIx:</b> Maths channel integrated x <b>Dix:</b> Impulse counter x <b>DTx:</b> Time counter x <b>VIx:</b> Combination x impulse counter <b>VTx:</b> Combination x time counter <b>DSx:</b> Digital status of digital input x <b>VSx:</b> Digital status of combination x <b>RL:</b> Relays conditions ++: Not all value can be transferred (see next chapter)
PROFIBUS-master -> Memo-Graph <b>MASTER-OUT:</b>	Structure of data, PROFIBUS-master sends to Memo-Graph:  The byte offset is shown after the colon. The bit position of an digital status is shown after the point.  <b>Ax:</b> Analogue input x <b>DSx:</b> Digital status of digital input x ++: Not all value can be transferred (see next chapter)

## 4 Data exchange

### 4.1 General

From PROFIBUS-master to Memo-Graph you can send only

- Analogue values
- Digital states

From Memo-Graph to PROFIBUS-master you can send

- Analogue values
- Integrated analogue values
- Maths channels
- Integrated maths channels
- Digital states
- Impulse counters
- Op. time counters
- Op. time counters with digital status
- Combinations impulse counter
- Combinations op. time counters
- Combinations logical operations
- Relays conditions

### 4.2 Reference data

It's possible to choose between two combinations of reference data, corresponding on the affords of the process.



Input/output(SPS)	Memo-Graph -> PROFIBUS-master <i>Input</i>	PROFIBUS-master -> Memo-Graph <i>Output</i>
100/60 byte	100 byte e.g. 8 analogue inputs plus integration and 4 math. functions	60 byte e.g. 8 analogue inputs and 37 digital states
70/90 byte	70 byte e.g. 8 integrated analogue inputs, 4 math. functions, 16 digital states and all relays conditions	90 byte e.g. 16 analogue inputs and 21 digital states

The content of the reference data has the following order:

From Memo-Graph to PROFIBUS-master:

Data	Interpretation	bytes
analogue input 1-16	32-bit floating point (IEEE-754) <sup>*1</sup> + status <sup>*4</sup>	5
analogue input 1-16 integrated	32-bit floating point (IEEE-754) <sup>*1</sup> + status <sup>*4</sup>	5
math. function 1-4	32-bit floating point (IEEE-754) <sup>*1</sup> + status <sup>*4</sup>	5
math. function 1-4 integrated	32-bit floating point (IEEE-754) <sup>*1</sup> + status <sup>*4</sup>	5
digital counter	32-bit floating point (IEEE-754) <sup>*1</sup> + status <sup>*4</sup>	5
digital operating time	32-bit floating point (IEEE-754) <sup>*1</sup> + status <sup>*4</sup>	5
combination counter	32-bit floating point (IEEE-754) <sup>*1</sup> + status <sup>*4</sup>	5
combination op. time	32-bit floating point (IEEE-754) <sup>*1</sup> + status <sup>*4</sup>	5
digital states	8 bit + status <sup>*2</sup>	2
combination states	8 bit + status <sup>*2</sup>	2
relays conditions	3 byte (18 bit used) <sup>*3</sup>	3

i.e. if 16 analogue values and 4 maths channels are sent, all "positions" are occupied, if the reference data structure 100/60 is selected (see chapter 4.2). No other value can be send. Identifiable at "+" under softkey **Info/DP-Slave** (see chapter 3.9).

From PROFIBUS-master to Memo-Graph:

Data	Interpretation	bytes
analogue value 1-16	32-bit floating point (IEEE-754) <sup>*1</sup> + status <sup>*4</sup>	5
digital states	8 bit + status <sup>*2</sup>	2

\*1 see chapter 4.2.1

\*2 see chapter 4.2.2

\*3 see chapter 4.2.4

\*4 see chapter 4.2.3

#### 4.2.1 32-bit floating point (IEEE-754)

Octet	8	7	6	5	4	3	2	1
1	SN	(E) 2 <sup>7</sup>	(E) 2 <sup>6</sup>					(E) 2 <sup>1</sup>
2	(E) 2 <sup>0</sup>	(M) 2 <sup>-1</sup>	(M) 2 <sup>-2</sup>					(M) 2 <sup>-7</sup>
3	(M) 2 <sup>-8</sup>							(M) 2 <sup>-15</sup>
4	(M) 2 <sup>-16</sup>							(M) 2 <sup>-23</sup>

SN = 0: positive value

SN = 1: negative value

E = exponent, M = mantissa

$$Zahl = -1^{SN} \cdot (1 + M) \cdot 2^{E-127}$$

Example:

40 F0 00 00 h = 0100 0000 1111 0000 0000 0000 0000 0000 b

$$\text{Value} = -1^0 \cdot 2^{129-127} \cdot (1 + 2^{-1} + 2^{-2} + 2^{-3})$$

$$= 1 \cdot 2^2 \cdot (1 + 0,5 + 0,25 + 0,125)$$

$$= 1 \cdot 4 \cdot 1,875 = 7,5$$

## 4.2.2 Digital states

A digital status is described with two bits in two bytes.

Byte 1 bit x = 0: status "Low"  
 = 1: status "High"  
 Byte 2 bit x = 0: inactive  
 = 1: active

## 4.2.3 Status

- for floating point:

8xH = x = 0: value O.K., no limits exceeded  
 x = 1: limit value 1 exceeded  
 x = 2: limit value 2 exceeded  
 x = 4: limit value 3 exceeded  
 x = 8: limit value 4 exceeded

x=1,2,4,8 only in direction Memo-Graph -> PROFIBUS-master.

10H = e.g. open circuit, waste value

otherwise = waste value

from PROFIBUS-master to Memo-Graph

80H: value O.K.  
 not 80H: value **not** O.K.

## 4.2.4 Relays

The relay conditions are described in 3 bytes:

Byte offset	Bit 7	Bit 6	Bit 5	Bit 4	Bit 3	Bit 2	Bit 1	Bit 0
0	Relay 1	Relay 2	Relay 3	Relay 4	Relay 5	OC	Relay 6	Relay 7
1	Relay 8	Relay 9	Relay 10	Relay 11	Relay 12	Relay 13	Relay 14	Relay 15
2	Relay 16	Relay 17	0	0	0	0	0	0

## 4.2.5 Example

From Memo-Graph to PROFIBUS-master:

channel	value	info	address	data
Analogue 1	4.1	A1:0	0, 1, 2, 3, 4	40 83 33 33 80
Digital impulse 2	12345,6	DI2:5	5, 6, 7, 8, 9	46 40 E6 66 80
Digital 1 status	High, active	DS1:10.7	10, 11	A0 E0
Digital 4 status	Low, active	DS4:10.6		
Combination 1 logic	High, active	VS1:10.5		

---

## 5 Implementation in Simatic S7

### 5.1 Network topology

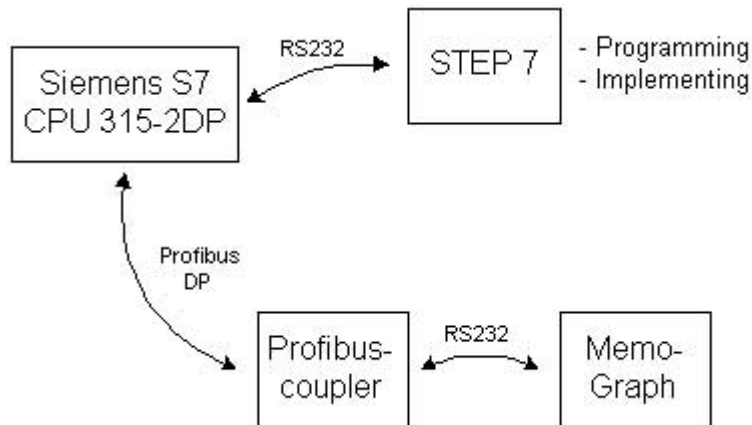

### 5.2 Hardware configuration

#### 5.2.1 Installation and preparation

##### 5.2.1.1 GSD file

In HW config:

- Copy the GSD and BMP files into the right directory of the configuration software STEP 7.  
e.g.: c:\...\Siemens\Step7\S7data\GSD  
c:\...\Siemens\Step7\S7data\NSBMP

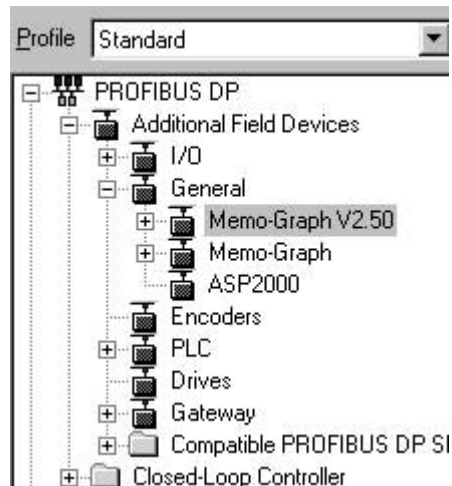

## 5.2.2 Slave configuration for Memo-Graph

In the HW config.:

- Drag the unit **Memo-Graph V2.50** from the hardware catalogue
- Insert the slave device out of the hardware catalogue  
-> PROFIBUS DP -> Additional field devices -> General  
in the PROFIBUS-DP network, set the node address.



Please differentiate between **Memo-Graph** (profibuscoupler < V1.51) and **Memo-Graph V2.50** (profibuscoupler V1.51 upwards). There is a label at the profibuscoupler with the version info (only when V1.51 upwards).

### Result:

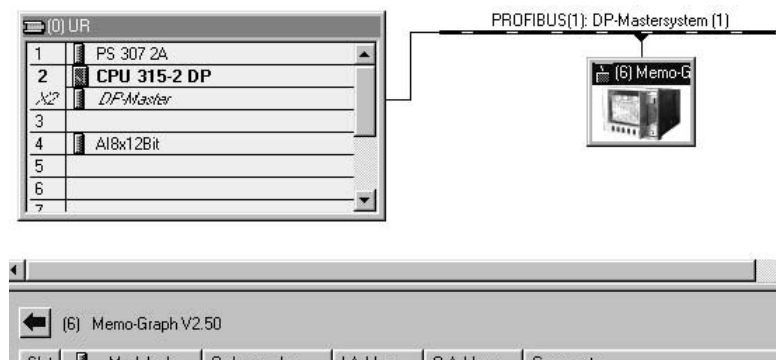

**Note:** The assigned device address has to agree with the current (hardware) device address.

- Select the right module for the data structure selected in Memo-Graph (100/60 or 70/90) and drag it to slot 0.

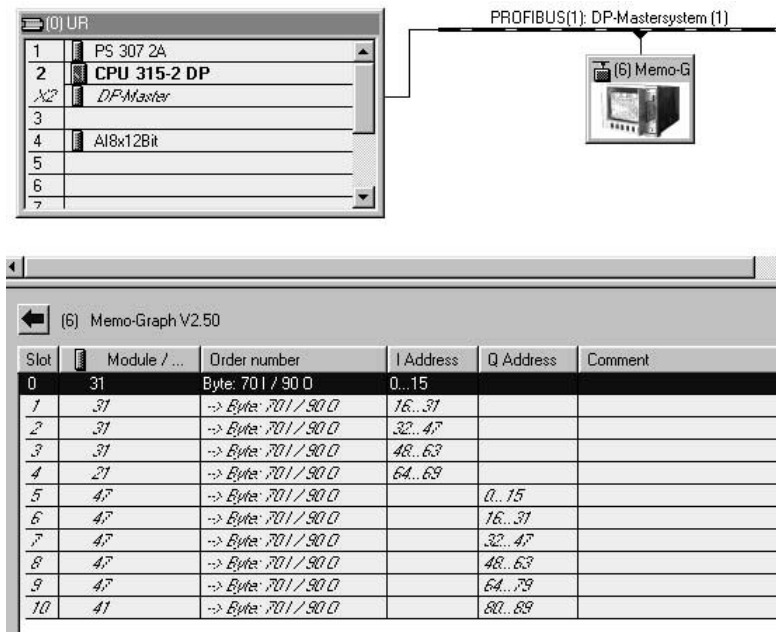

- The addresses for inputs resp. outputs of the reference data are shown as I Address and Q Address, here with hardware address 6 the I addresses 0...69 and Q addresses 0...89.

---

### 5.2.3 Configuration download

- Save and compile the configuration.
- Download configuration into the CPU with menu **PLC -> Download to Module**.

If the LED "BUSF" still lights after configuration download, the projected network may not fit the physically existing network or the slave module configuration has been done wrongly. Check your network and configuration to discover the fault.

## 5.3 Specimen program

### 5.3.1 Address list

Input/Output data address space:

I-address: 0  
Q-address: 0

Settings Memo-Graph: (see chapter 3.9)

MASTER-IN:           A1:0, A2:5, A3:10  
MASTER-OUT:         A4:0, A5:5

### 5.3.2 Program in function block

The following program parts show, how to read and write inconsistent data.  
The special functions SFC14 and SFC15 don't function because the data is not consistent.

FC1:

```
L   ED   0           // Get 4 byte
T   MD   0           // Transfer to marker 0
L   EB   4           // Get 1 byte status
T   MB   4           // Status to marker 4

L   ED   5           // Get 4 byte
T   MD   5           // Transfer to marker 5
L   EB   9           // Get 1 byte status
T   MB   9           // Status to marker 9

L   ED   10          // Get 4 byte
T   MD   10          // Transfer to marker 10
L   EB   14          // Get 1 byte status
T   MB   14          // Status to marker 14
```

FC2:

```
L   MD   15          // Get FLOATING POINT out of marker
T   AD   0           // and send
L   MB   19          // Status out of marker
T   AB   4           // and send

L   MD   20          // Get FLOATING POINT out of marker
T   AD   5           // and send
L   MB   24          // Status out of marker
T   AB   9           // and send
```

Function calls in OB1:

```
CALL FC1
CALL FC2
```



## 5.4 Monitoring

### 5.4.1 Variable table

In the variable editor marker addresses can be addressed and values accessed. Define the permitted addresses in a new variable table.

Example:

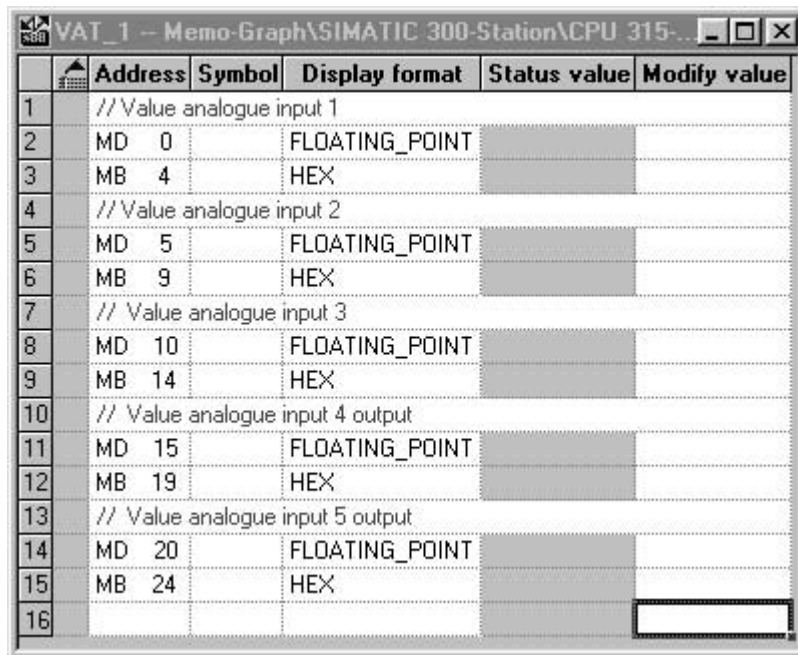

	Address	Symbol	Display format	Status value	Modify value
1					
	// Value analogue input 1				
2	MD 0		FLOATING_POINT		
3	MB 4		HEX		
4					
	// Value analogue input 2				
5	MD 5		FLOATING_POINT		
6	MB 9		HEX		
7					
	// Value analogue input 3				
8	MD 10		FLOATING_POINT		
9	MB 14		HEX		
10					
	// Value analogue input 4 output				
11	MD 15		FLOATING_POINT		
12	MB 19		HEX		
13					
	// Value analogue input 5 output				
14	MD 20		FLOATING_POINT		
15	MB 24		HEX		
16					

### 5.4.2 Monitoring the slave data

Establish the communication between CPU and PG/PC. Enable the monitor function.

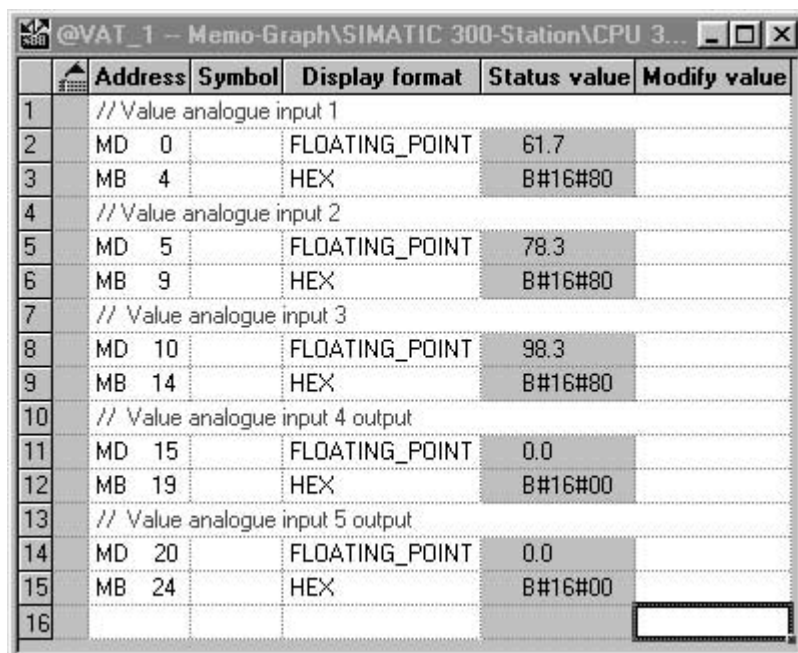

	Address	Symbol	Display format	Status value	Modify value
1					
	// Value analogue input 1				
2	MD 0		FLOATING_POINT	61.7	
3	MB 4		HEX	B#16#80	
4					
	// Value analogue input 2				
5	MD 5		FLOATING_POINT	78.3	
6	MB 9		HEX	B#16#80	
7					
	// Value analogue input 3				
8	MD 10		FLOATING_POINT	98.3	
9	MB 14		HEX	B#16#80	
10					
	// Value analogue input 4 output				
11	MD 15		FLOATING_POINT	0.0	
12	MB 19		HEX	B#16#00	
13					
	// Value analogue input 5 output				
14	MD 20		FLOATING_POINT	0.0	
15	MB 24		HEX	B#16#00	
16					

### 5.4.3 Modify values

For a write job in the data sink of Memo-Graph, the status good (80h) has first to be transferred into the device. Then, the value can be transferred into the data sink as a 4 byte floating point.

- Set the status byte to 80 (hex).

	Address	Symbol	Display format	Status value	Modify value
1		// Value analogue input 1			
2	MD 0		FLOATING_POINT	79.2	
3	MB 4		HEX	B#16#80	
4		// Value analogue input 2			
5	MD 5		FLOATING_POINT	84.0	
6	MB 9		HEX	B#16#80	
7		// Value analogue input 3			
8	MD 10		FLOATING_POINT	47.7	
9	MB 14		HEX	B#16#80	
10		// Value analogue input 4 output			
11	MD 15		FLOATING_POINT	0.0	
12	MB 19		HEX	B#16#00	B#16#80
13		// Value analogue input 5 output			
14	MD 20		FLOATING_POINT	0.0	
15	MB 24		HEX	B#16#00	
16					

- Menu **V**ariable -> **A**ctivate Modify Values

Result:

The status value has been transferred into the device.

	Address	Symbol	Display format	Status value	Modify value
1		// Value analogue input 1			
2	MD 0		FLOATING_POINT	44.2	
3	MB 4		HEX	B#16#80	
4		// Value analogue input 2			
5	MD 5		FLOATING_POINT	19.8	
6	MB 9		HEX	B#16#80	
7		// Value analogue input 3			
8	MD 10		FLOATING_POINT	33.8	
9	MB 14		HEX	B#16#80	
10		// Value analogue input 4 output			
11	MD 15		FLOATING_POINT	0.0	
12	MB 19		HEX	B#16#80	B#16#80
13		// Value analogue input 5 output			
14	MD 20		FLOATING_POINT	0.0	
15	MB 24		HEX	B#16#00	
16					

- Set the desired value for transmitting into the device data sink.

	Address	Symbol	Display format	Status value	Modify value
1					
	// Value analogue input 1				
2	MD 0		FLOATING_POINT	61.7	
3	MB 4		HEX	B#16#80	
4					
	// Value analogue input 2				
5	MD 5		FLOATING_POINT	30.9	
6	MB 9		HEX	B#16#80	
7					
	// Value analogue input 3				
8	MD 10		FLOATING_POINT	9.4	
9	MB 14		HEX	B#16#80	
10					
	// Value analogue input 4 output				
11	MD 15		FLOATING_POINT	0.0	22.25
12	MB 19		HEX	B#16#80	B#16#80
13					
	// Value analogue input 5 output				
14	MD 20		FLOATING_POINT	0.0	
15	MB 24		HEX	B#16#00	
16					

- Menu **Variable** -> **Activate Modify Values**

Result:

	Address	Symbol	Display format	Status value	Modify value
1					
	// Value analogue input 1				
2	MD 0		FLOATING_POINT	61.7	
3	MB 4		HEX	B#16#80	
4					
	// Value analogue input 2				
5	MD 5		FLOATING_POINT	78.0	
6	MB 9		HEX	B#16#80	
7					
	// Value analogue input 3				
8	MD 10		FLOATING_POINT	111.4	
9	MB 14		HEX	B#16#80	
10					
	// Value analogue input 4 output				
11	MD 15		FLOATING_POINT	22.25	22.25
12	MB 19		HEX	B#16#80	B#16#80
13					
	// Value analogue input 5 output				
14	MD 20		FLOATING_POINT	0.0	
15	MB 24		HEX	B#16#00	
16					

The desired value has been transmitted into the Memo-Graph data sink and is shown on the device display.

## 5.5 Status codes

### 5.5.1 Table

Status	Code	Description
Bad, Sensor failure	10H	Sensor failure, Bad value
Good, ok	80H	No sensor failure
Good, ok, limit 1	81H	Out value exceeds the limit 1
Good, ok, limit 2	82H	Out value exceeds the limit 2
Good, ok, limit 3	84H	Out value exceeds the limit 3
Good, ok, limit 4	88H	Out value exceeds the limit 4

81H, 82H, 84H and 88H only transmitted from Memo-Graph to PROFIBUS-master.

### 5.5.2 Example of status codes

Measured value and status are good in the defined range:

The screenshot shows a window titled "@VAT\_1 - Memo-Graph\SIMATIC 300-Station\CPU 3...". It displays a table with the following columns: Address, Symbol, Display format, Status value, and Modify value. The table contains data for five analogue inputs and their corresponding outputs.

	Address	Symbol	Display format	Status value	Modify value
1					
	// Value analogue input 1				
2	MD 0		FLOATING_POINT	79.2	
3	MB 4		HEX	B#16#80	
4					
	// Value analogue input 2				
5	MD 5		FLOATING_POINT	19.8	
6	MB 9		HEX	B#16#80	
7					
	// Value analogue input 3				
8	MD 10		FLOATING_POINT	15.8	
9	MB 14		HEX	B#16#80	
10					
	// Value analogue input 4 output				
11	MD 15		FLOATING_POINT	22.25	22.25
12	MB 19		HEX	B#16#80	B#16#80
13					
	// Value analogue input 5 output				
14	MD 20		FLOATING_POINT	0.0	
15	MB 24		HEX	B#16#00	
16					

The measured value has exceeded the limit 2:

	Address	Symbol	Display format	Status value	Modify value
1					
	// Value analogue input 1				
2	MD 0		FLOATING_POINT	61.7	
3	MB 4		HEX	B#16#82	
4	// Value analogue input 2				
5	MD 5		FLOATING_POINT	34.1	
6	MB 9		HEX	B#16#80	
7	// Value analogue input 3				
8	MD 10		FLOATING_POINT	91.3	
9	MB 14		HEX	B#16#80	
10	// Value analogue input 4 output				
11	MD 15		FLOATING_POINT	22.25	22.25
12	MB 19		HEX	B#16#80	B#16#80
13	// Value analogue input 5 output				
14	MD 20		FLOATING_POINT	0.0	
15	MB 24		HEX	B#16#00	
16					

Sensor failure, the value is not useable.

	Address	Symbol	Display format	Status value	Modify value
1					
	// Value analogue input 1				
2	MD 0		FLOATING_POINT	0.0	
3	MB 4		HEX	B#16#10	
4	// Value analogue input 2				
5	MD 5		FLOATING_POINT	0.0	
6	MB 9		HEX	B#16#10	
7	// Value analogue input 3				
8	MD 10		FLOATING_POINT	0.0	
9	MB 14		HEX	B#16#10	
10	// Value analogue input 4 output				
11	MD 15		FLOATING_POINT	8.0	22.25
12	MB 19		HEX	B#16#00	B#16#80
13	// Value analogue input 5 output				
14	MD 20		FLOATING_POINT	0.0	
15	MB 24		HEX	B#16#00	
16					

## 6 Troubleshooting

Problem	Cause	Adjustment
Profibuscoupler not detected after turn on Memo-Graph: Message at screen "Profibuscoupler not connected"	Memo-Graph is not able to contact the profibuscoupler.	Profibuscoupler turn off/on. Then turn off/on Memo-Graph
	The serial connection between Memo-Graph and profibuscoupler is wrong.	Please check connection. Have a look at the assignment of the colours (Chapter 2.2).
Hint "DP" doesn't appear in the headline.	Once-only initialisation hasn't been carried out.	Carry out once-only initialisation. (Chapter 3.1).
	Data interface in set up is not activated.	Please activate data interface in set up (Chapter 3.3).
Hint "Automatically baudrate detection failed. Please activate DP-master!"	The detection of the baud rate at DP-side has failed, because of absent activity of master.	- Activate PROFIBUS-master - Select the correct baud rate in set up (Chapter 3.3).
Info/DP-Slave: "No cyclic data transfer active on DP-side"	Reference data (70/90 or 100/60) is different to the configuration in PROFIBUS-master.	Compare with reference data (Chapter 4.2) of PROFIBUS-master. Additional information about the configuration string you can get on the enclosed disk in file readme.pdf.
	PROFIBUS-master.	Please activate PROFIBUS-master
	Baud rate is different.	Compare baud rate.
	Slave-address wrong	The slave-address of Memo-Graph has to match with the projected DP-slave-address (< 126).
Memo-Graph displays only dashes (-----), even though the PROFIBUS-master sends values.	The transmitted value consists of 5 bytes (4 bytes value and 1 byte status). The <b>status has to be 80H</b> , so that Memo-Graph accepts this value. If the status is not 80H the Memo-Graph detects.	Set status (5. byte) to 80H in PROFIBUS-master.
	The status is 80H, but the value is not a valid IEEE-754-floatingpoint.	Make arrangements that a valid IEEE-754-floatingpoint will be sent.
	The output address range of the PROFIBUS-master has gaps.	Trim the output address range, so that there is no.

---

## 7 Index

### **A**

Analogue inputs .....6

### **B**

Baudrate.....5

### **C**

Combining digital channels .....8

Complete delivery .....2

Connections/terminal layout.....3

Control input.....7

### **D**

Data exchange .....10

Data interface.....4, 9

Digital boards .....7

Digital inputs.....7

DP-Slave-Module .....5

### **E**

Event + op. time counter .....7

### **F**

Floating point.....11

Function block.....15

Functionality .....3

### **G**

GSD file.....13

### **H**

Hardware configuration .....13

### **I**

Impulse counter.....7

Initialisierungsphase ..... 14

initialization once-only ..... 4

Input addresses ..... 14

Inputs..... 5

Installation ..... 3

### **M**

Maths channels ..... 6

### **O**

On/Off events ..... 7

Op. time counter ..... 7

Output addresses ..... 14

Outputs ..... 5

### **R**

Reference data ..... 10

Relays conditions ..... 8

Relays/OC ..... 8

### **S**

Serial RS232 interface..... 4

Set up ..... 5

Setting up ..... 4

Setup ..... 4

Simatic S7 ..... 13

Slave-address ..... 5

Specimen program ..... 15

Status codes..... 19

### **T**

Timeout ..... 5

Transportation damage ..... 2

## Europe

### Austria

□ Endress+Hauser Ges.m.b.H.  
Wien  
Tel. ++43 (1) 88056-0, Fax (1) 88056-35

### Belarus

Belorgintez  
Minsk  
Tel. ++375 (172) 263166, Fax (172) 263111

### Belgium / Luxembourg

□ Endress+Hauser S.A./N.V.  
Brussels  
Tel. ++32 (2) 2480600, Fax (2) 2480553

### Bulgaria

INTERTECH-AUTOMATION  
Sofia  
Tel. ++359 (2) 664869, Fax (2) 9631389

### Croatia

□ Endress+Hauser GmbH+Co.  
Zagreb  
Tel. ++385 (1) 6637785, Fax (1) 6637823

### Cyprus

I+G Electrical Services Co. Ltd.  
Nicosia  
Tel. ++357 (2) 484788, Fax (2) 484690

### Czech Republic

□ Endress+Hauser GmbH+Co.  
Praha  
Tel. ++420 (26) 6784200, Fax (26) 6784179

### Denmark

□ Endress+Hauser A/S  
Søborg  
Tel. ++45 (70) 131132, Fax (70) 132133

### Estonia

Elvi-Aqua  
Tartu  
Tel. ++372 (7) 422726, Fax (7) 422727

### Finland

□ Endress+Hauser Oy  
Espoo  
Tel. ++358 (9) 8596155, Fax (9) 8596055

### France

□ Endress+Hauser  
Huningue  
Tel. ++33 (3) 89696768, Fax (3) 89694802

### Germany

□ Endress+Hauser Meßtechnik GmbH+Co.  
Weil am Rhein  
Tel. ++49 (7621) 97501, Fax (7621) 975555

### Great Britain

□ Endress+Hauser Ltd.  
Manchester  
Tel. ++44 (161) 2865000, Fax (161) 9981841

### Greece

I & G Building Services Automation S.A.  
Athens  
Tel. ++30 (1) 9241500, Fax (1) 9221714

### Hungary

Mile Ipari-Elektro  
Budapest  
Tel. ++36 (1) 2615535, Fax (1) 2615535

### Iceland

Vatnshreinsun HF  
Reykjavik  
Tel. ++345 (5) 619616, Fax (5) 619617

### Ireland

Flomeaco Company Ltd.  
Kildare  
Tel. ++335 (45) 868615, Fax (45) 868182

### Italy

□ Endress+Hauser Italia S.p.A.  
Cernusco s/N Milano  
Tel. ++39 (02) 92106421, Fax (02) 92107153

### Latvia

Raita Ltd.  
Riga  
Tel. ++371 (7) 312897, Fax (7) 312894

### Lithuania

Agava Ltd.  
Kaunas  
Tel. ++370 (7) 202410, Fax (7) 207414

### Netherlands

□ Endress+Hauser B.V.  
Naarden  
Tel. ++31 (35) 6958611, Fax (35) 6958825

### Norway

□ Endress+Hauser A/S  
Tranby  
Tel. ++47 (32) 859850, Fax (32) 859851

### Poland

□ Endress+Hauser Polska Sp. z o.o.  
Warszawa  
Tel. ++48 (22) 7201090, Fax (22) 7201085

### Portugal

Tecnisis - Tecnica de Sistemas Industriais  
Linda-a-Velha  
Tel. ++351 (1) 4172637, Fax (1) 4185278

### Romania

Romconseng SRL  
Bucharest  
Tel. ++40 (1) 4101634, Fax (1) 4101634

### Russia

□ Endress+Hauser Moscow Office  
Moscow  
Tel. ++709 (5) 1587571, Fax (5) 1589864

### Slovak Republic

Transcom Technik s.r.o.  
Bratislava  
Tel. ++421 (74) 4888684, Fax (74) 4887112

### Slovenia

□ Endress+Hauser D.O.O.  
Ljubljana  
Tel. ++386 (61) 1592217, Fax (61) 1592298

### Spain

□ Endress+Hauser S.A.  
Barcelona  
Tel. ++34 (93) 4803366, Fax (93) 4733839

### Sweden

□ Endress+Hauser AB  
Sollentuna  
Tel. ++46 (8) 55511600, Fax (8) 55511600

### Switzerland

□ Endress+Hauser Metso AG  
Reinach/BL 1  
Tel. ++41 (61) 7157575, Fax (61) 7111650

### Turkey

Intek Endüstriyel Ölçü ve Kontrol Sistemleri  
Istanbul  
Tel. ++90 (212) 2751355, Fax (212) 2662775

### Ukraine

Industria Ukraina  
Kiev  
Tel. ++380 (44) 26881, Fax (44) 26908

### Yugoslavia

Meris d.o.o.  
Beograd  
Tel. ++381 (11) 4446164, Fax (11) 4441966

## Africa

### Egypt

Anasia  
Heliopolis/Cairo  
Tel. ++20 (2) 417900, Fax (2) 417900

### Morocco

Oussama S.A.  
Casablanca  
Tel. ++212 (2) 241338, Fax (2) 402657

### Nigeria

J F Technical Invest. Nig. Ltd.  
Lagos  
Tel. ++234 (1) 62234546, Fax (1) 62234548

### South Africa

□ Endress+Hauser Pty. Ltd.  
Sandton  
Tel. ++27 (11) 4441386, Fax (11) 4441977

### Tunisia

Controle, Maintenance et Regulation  
Tunis  
Tel. ++216 (1) 793077, Fax (1) 788595

## America

### Argentina

□ Endress+Hauser Argentina S.A.  
Buenos Aires  
Tel. ++54 (1) 145227970, Fax (1) 145227909

### Bolivia

Tritec S.R.L.  
BOL - Cochabamba  
Tel. ++591 (42) 56993, Fax (42) 50981

### Brazil

□ Samson Endress+Hauser Ltda.  
Sao Paulo  
Tel. ++55 (11) 50313455, Fax (11) 50313067

### Canada

□ Endress+Hauser Ltd.  
Burlington, Ontario  
Tel. ++1 (905) 6819292, Fax (905) 6819444

### Chile

Endress+Hauser Chile Ltd.  
Las Condes - Santiago  
Tel. ++56 (2) 3213009, Fax (2) 3213025

### Colombia

Colsein Ltd.  
Bogota D.C.  
Tel. ++57 (1) 2367659, Fax (1) 6107868

### Costa Rica

EURO-TEC S.A.  
San Jose  
Tel. ++506 (2) 961542, Fax (2) 961542

### Ecuador

Insetec Cia. Ltda.  
Quito  
Tel. ++593 (2) 269148, Fax (2) 461833

### Guatemala

ACISA Automatizacion Y Control Industrial S.A.  
Ciudad de Guatemala, C.A.  
Tel. ++502 (3) 345985, Fax (2) 327431

### Mexico

□ Endress+Hauser I.I.  
Mexico City  
Tel. ++52 (5) 568965, Fax (5) 568418

### Paraguay

Incoel S.R.L.  
Asuncion  
Tel. ++595 (21) 213989, Fax (21) 226583

### Uruguay

Circular S.A.  
Montevideo  
Tel. ++598 (2) 925785, Fax (2) 929151

### USA

□ Endress+Hauser Inc.  
Greenwood, Indiana  
Tel. ++1 (317) 5357138, Fax (317) 5358489

### Venezuela

H. Z. Instrumentos C.A.  
Caracas  
Tel. ++58 (2) 9440966, Fax (2) 9444554

## Asia

### China

□ Endress+Hauser Shanghai  
Instrumentation Co. Ltd.  
Shanghai  
Tel. ++86 (21) 54902300, Fax (21) 54902303

### □ Endress+Hauser Beijing Office

Beijing  
Tel. ++86 (10) 68344058, Fax (10) 68344068

### □ Endress+Hauser (H.K.) Ltd.

Hong Kong  
Tel. ++852 (2) 5283120, Fax (2) 8654171

### India

□ Endress+Hauser (India) Pvt Ltd.  
Mumbai  
Tel. ++91 (22) 8521458, Fax (22) 8521927

### Indonesia

PT Grama Bazita  
Jakarta  
Tel. ++62 (21) 7975083, Fax (21) 7975089

### Japan

□ Sakura Endress Co., Ltd.  
Tokyo  
Tel. ++81 (422) 540611, Fax (422) 550275

### Malaysia

□ Endress+Hauser (M) Sdn. Bhd.  
Petaling Jaya, Selangor Darul Ehsan  
Tel. ++60 (3) 7334848, Fax (3) 7338800

### Pakistan

Speedy Automation  
Karachi  
Tel. ++92 (21) 7722953, Fax (21) 7736884

### Papua New Guinea

SBS Electrical Pty Limited  
Port Moresby  
Tel. ++675 (3) 251188, Fax (3) 259556

### Philippines

Brenton Industries Inc.  
Makati Metro Manila  
Tel. ++63 (2) 6388041, Fax (2) 6388042

### Singapore

□ Endress+Hauser (S.E.A.) Pte., Ltd.  
Singapore  
Tel. ++65 (5) 668222, Fax (2) 666848

### South Korea

□ Endress+Hauser (Korea) Co., Ltd.  
Seoul  
Tel. ++82 (2) 6587200, Fax (2) 6592838

### Taiwan

Kingjari Corporation  
Taipei R.O.C.  
Tel. ++886 (2) 27183938, Fax (2) 27134190

### Thailand

□ Endress+Hauser Ltd.  
Bangkok  
Tel. ++66 (2) 996781120, Fax (2) 9967810

### Vietnam

Tan Viet Bao Co. Ltd.  
Ho Chi Minh City  
Tel. ++84 (8) 8335225, Fax (8) 8335227

### Iran

Telephona Technical Services Co. Ltd.  
Tehran  
Tel. ++98 (21) 8746750, Fax (21) 8737295

### Israel

Instrumetrics Industrial Control Ltd.  
Tel-Aviv  
Tel. ++972 (3) 6480205, Fax (3) 6471992

### Jordan

A.P. Parpas Engineering S.A.  
Amman  
Tel. ++962 (6) 4643246, Fax (6) 4645707

### Kingdom of Saudi Arabia

Anasia  
Jeddah  
Tel. ++966 (2) 6710014, Fax (2) 6725929

### Kuwait

Kuwait Maritime & Mercantile Co. K.S.C.  
Safat  
Tel. ++965 (2) 441481, Fax (2) 441486

### Lebanon

Nabil Ibrahim  
Jbeil  
Tel. ++961 (3) 254052, Fax (9) 548038

### Sultanate of Oman

Mustafa & Jawad Science & Industry Co.  
L.L.C.  
Ruwi  
Tel. ++968 (60) 2009, Fax (60) 7066

### United Arab Emirates

Descon Trading EST.  
Dubai  
Tel. ++971 (4) 653651, Fax (4) 653264

### Yemen

Yemen Company for Ghee and Soap Industry  
Taiz  
Tel. ++976 (4) 230664, Fax (4) 212338

## Australia + New Zealand

### Australia

ALSTOM Australia Ltd.  
Sydney  
Tel. ++61 (2) 97224777, Fax (2) 97224888

### New Zealand

EMC Industrial Group Ltd  
Auckland  
Tel. ++64 (9) 4155110, Fax (9) 4155115

## All other countries

□ Endress+Hauser GmbH+Co.  
Instruments International  
D-Weil am Rhein  
Germany  
Tel. ++49 (7621) 97502,  
Fax (7621) 975345

□ Unternehmen der Endress+Hauser-Gruppe

□ Members of the Endress+Hauser Group

Endress + Hauser

The Power of Know How

