

# Brief Operating Instructions

## **Proline Promass**

Part 1 of 2  
Coriolis sensor



These Instructions are Brief Operating Instructions; they are not a substitute for the Operating Instructions pertaining to the device.

These Brief Operating Instructions contain all of the information on the sensor. Please also follow the Brief Operating Instructions for the transmitter during commissioning →  3.

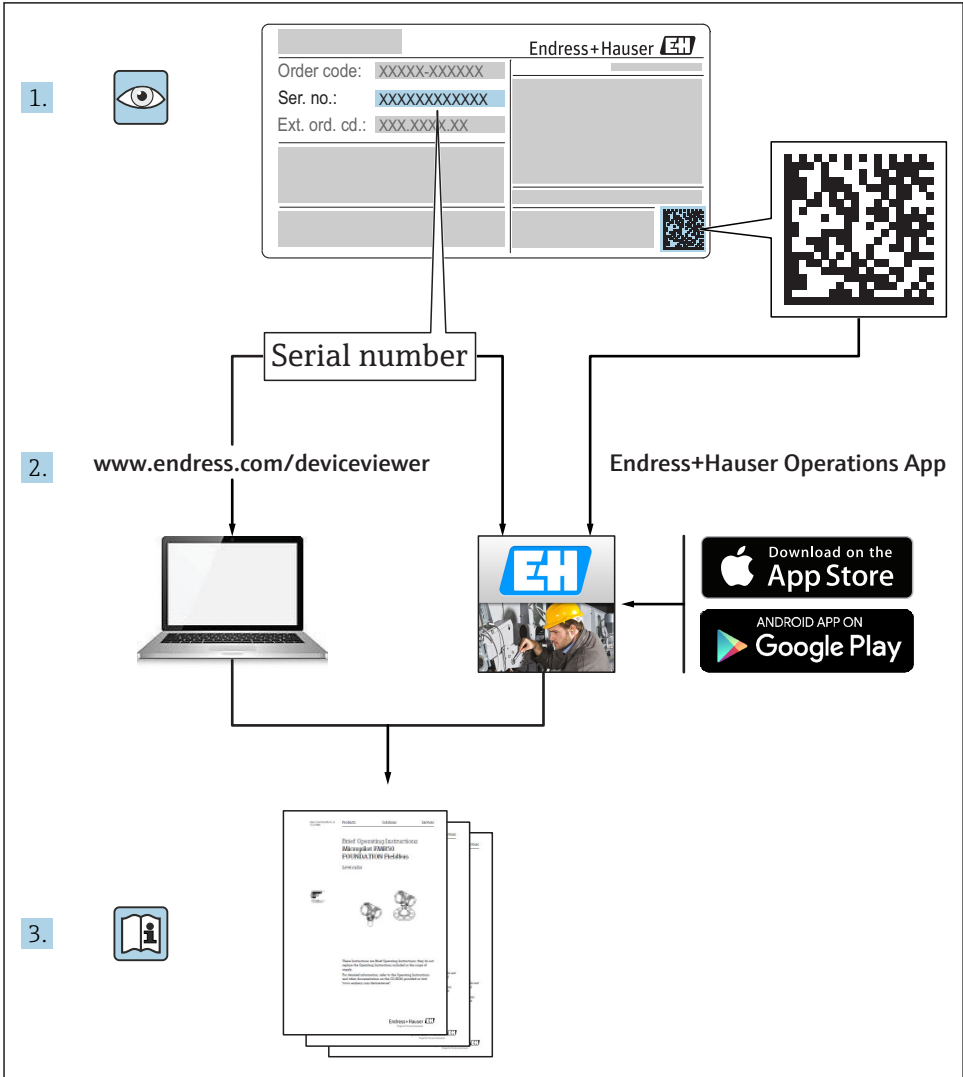

A0023555

## Brief Operating Instructions for the device

The device consists of a transmitter and a sensor.

The process of commissioning these two components is described in two separate manuals:

- Sensor Brief Operating Instructions
- Transmitter Brief Operating Instructions

Please refer to both Brief Operating Instructions when commissioning the device as the contents of the manuals complement one another:

### Sensor Brief Operating Instructions

The Sensor Brief Operating Instructions are aimed at specialists with responsibility for installing the measuring device.

- Incoming acceptance and product identification
- Storage and transport
- Installation

### Transmitter Brief Operating Instructions

The Transmitter Brief Operating Instructions are aimed at specialists with responsibility for commissioning, configuring and parameterizing the measuring device (until the first measured value).

- Product description
- Installation
- Electrical connection
- Operation options
- System integration
- Commissioning
- Diagnostic information

## Additional device documentation



These Brief Operating Instructions are the **Sensor Brief Operating Instructions**.

The "Transmitter Brief Operating Instructions" are available via:

- Internet: [www.endress.com/deviceviewer](http://www.endress.com/deviceviewer)
- Smart phone/tablet: *Endress+Hauser Operations App*

Detailed information about the device can be found in the Operating Instructions and the other documentation:

- Internet: [www.endress.com/deviceviewer](http://www.endress.com/deviceviewer)
- Smart phone/tablet: *Endress+Hauser Operations App*





# Table of contents

<b>1</b>	<b>Document information</b>	<b>5</b>
1.1	Symbols used	5
<b>2</b>	<b>Basic safety instructions</b>	<b>7</b>
2.1	Requirements for the personnel	7
2.2	Designated use	7
2.3	Workplace safety	8
2.4	Operational safety	8
2.5	Product safety	8
2.6	IT security	9
<b>3</b>	<b>Incoming acceptance and product identification</b>	<b>9</b>
3.1	Incoming acceptance	9
3.2	Product identification	10
<b>4</b>	<b>Storage and transport</b>	<b>11</b>
4.1	Storage conditions	11
4.2	Transporting the product	11
<b>5</b>	<b>Installation</b>	<b>13</b>
5.1	Installation conditions	13
5.2	Mounting the measuring device	29
5.3	Post-installation check	31
<b>6</b>	<b>Disposal</b>	<b>31</b>
6.1	Removing the measuring device	31
6.2	Disposing of the measuring device	31











# 1 Document information

## 1.1 Symbols used





### 1.1.1 Safety symbols



Symbol	Meaning
	<b>DANGER!</b> This symbol alerts you to a dangerous situation. Failure to avoid this situation will result in serious or fatal injury.
	<b>WARNING!</b> This symbol alerts you to a dangerous situation. Failure to avoid this situation can result in serious or fatal injury.
	<b>CAUTION!</b> This symbol alerts you to a dangerous situation. Failure to avoid this situation can result in minor or medium injury.
	<b>NOTE!</b> This symbol contains information on procedures and other facts which do not result in personal injury.

### 1.1.2 Symbols for certain types of information





Symbol	Meaning	Symbol	Meaning
	<b>Permitted</b> Procedures, processes or actions that are permitted.		<b>Preferred</b> Procedures, processes or actions that are preferred.
	<b>Forbidden</b> Procedures, processes or actions that are forbidden.		<b>Tip</b> Indicates additional information.
	Reference to documentation		Reference to page
	Reference to graphic		Series of steps
	Result of a step		Visual inspection

### 1.1.3 Electrical symbols





Symbol	Meaning	Symbol	Meaning
	Direct current		Alternating current
	Direct current and alternating current		<b>Ground connection</b> A grounded terminal which, as far as the operator is concerned, is grounded via a grounding system.

Symbol	Meaning
	<b>Protective ground connection</b> A terminal which must be connected to ground prior to establishing any other connections.
	<b>Equipotential connection</b> A connection that has to be connected to the plant grounding system: This may be a potential equalization line or a star grounding system depending on national or company codes of practice.





### 1.1.4 Communication symbols

Symbol	Meaning	Symbol	Meaning
	<b>Wireless Local Area Network (WLAN)</b> Communication via a wireless, local network.		<b>Bluetooth</b> Wireless data transmission between devices over a short distance.
	<b>LED</b> Light emitting diode is off.		<b>LED</b> Light emitting diode is on.
	<b>LED</b> Light emitting diode is flashing.		

### 1.1.5 Tool symbols

Symbol	Meaning	Symbol	Meaning
	Torx screwdriver		Flat blade screwdriver
	Cross-head screwdriver		Allen key
	Open-ended wrench		

### 1.1.6 Symbols in graphics

Symbol	Meaning	Symbol	Meaning
1, 2, 3,...	Item numbers		Series of steps
A, B, C, ...	Views	A-A, B-B, C-C, ...	Sections
	Hazardous area		Safe area (non-hazardous area)
	Flow direction		

## 2 Basic safety instructions

### 2.1 Requirements for the personnel

The personnel must fulfill the following requirements for its tasks:

- ▶ Trained, qualified specialists must have a relevant qualification for this specific function and task.
- ▶ Are authorized by the plant owner/operator.
- ▶ Are familiar with federal/national regulations.
- ▶ Before starting work, read and understand the instructions in the manual and supplementary documentation as well as the certificates (depending on the application).
- ▶ Follow instructions and comply with basic conditions.

### 2.2 Designated use

#### Application and media

The measuring device described in these Instructions is intended only for flow measurement of liquids and gases.

Depending on the version ordered, the measuring device can also measure potentially explosive, flammable, poisonous and oxidizing media.

Measuring devices for use in hazardous areas, in hygienic applications or where there is an increased risk due to process pressure, are labeled accordingly on the nameplate.

To ensure that the measuring device remains in proper condition for the operation time:

- ▶ Only use the measuring device in full compliance with the data on the nameplate and the general conditions listed in the Operating Instructions and supplementary documentation.
- ▶ Based on the nameplate, check whether the ordered device is permitted for the intended use in the hazardous area (e.g. explosion protection, pressure vessel safety).
- ▶ Use the measuring device only for media to which the process-wetted materials are sufficiently resistant.
- ▶ If the measuring device is not operated at atmospheric temperature, compliance with the relevant basic conditions specified in the associated device documentation is absolutely essential: "Documentation" section..
- ▶ Protect the measuring device permanently against corrosion from environmental influences.

#### Incorrect use

Non-designated use can compromise safety. The manufacturer is not liable for damage caused by improper or non-designated use.

#### WARNING

#### Danger of breakage due to corrosive or abrasive fluids!

- ▶ Verify the compatibility of the process fluid with the sensor material.
- ▶ Ensure the resistance of all fluid-wetted materials in the process.
- ▶ Keep within the specified pressure and temperature range.

**NOTICE****Verification for borderline cases:**

- ▶ For special fluids and fluids for cleaning, Endress+Hauser is glad to provide assistance in verifying the corrosion resistance of fluid-wetted materials, but does not accept any warranty or liability as minute changes in the temperature, concentration or level of contamination in the process can alter the corrosion resistance properties.

**Residual risks****⚠ WARNING**

**The electronics and the medium may cause the surfaces to heat up. This presents a burn hazard!**

- ▶ For elevated fluid temperatures, ensure protection against contact to prevent burns.

**⚠ WARNING**

**Danger of housing breaking due to measuring tube breakage!**

- ▶ In the event of a measuring tube breakage for a device version without rupture disk it is possible for the pressure loading capacity of the sensor housing to be exceeded. This can lead to rupture or failure of the sensor housing.

## 2.3 Workplace safety

For work on and with the device:

- ▶ Wear the required personal protective equipment according to federal/national regulations.

For welding work on the piping:

- ▶ Do not ground the welding unit via the measuring device.

If working on and with the device with wet hands:

- ▶ Due to the increased risk of electric shock, gloves must be worn.

## 2.4 Operational safety

Risk of injury!

- ▶ Operate the device in proper technical condition and fail-safe condition only.
- ▶ The operator is responsible for interference-free operation of the device.

## 2.5 Product safety

This measuring device is designed in accordance with good engineering practice to meet state-of-the-art safety requirements, has been tested, and left the factory in a condition in which it is safe to operate.

It meets general safety standards and legal requirements. It also complies with the EU directives listed in the device-specific EU Declaration of Conformity. Endress+Hauser confirms this by affixing the CE mark to the device.



## 2.6 IT security

We only provide a warranty if the device is installed and used as described in the Operating Instructions. The device is equipped with security mechanisms to protect it against any inadvertent changes to the device settings.

IT security measures in line with operators' security standards and designed to provide additional protection for the device and device data transfer must be implemented by the operators themselves.

## 3 Incoming acceptance and product identification

### 3.1 Incoming acceptance



A0028673



1  
2



1  
2

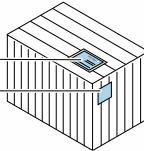

Are the order codes on the delivery note (1) and the product sticker (2) identical?

A0029314

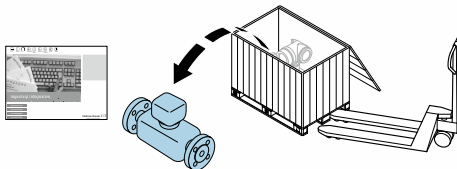

A0029315



A0028673

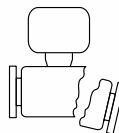
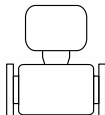

Are the goods undamaged?

A0029316



A0028673

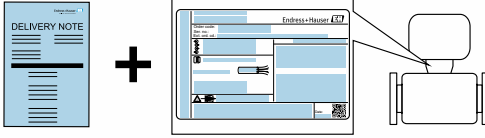

Do the nameplate data match the ordering information on the delivery note?

A0029317



A0028673



Is the CD-ROM with the Technical Documentation (depends on device version) and documents present?

A0029318

- 
i
 ■ If one of the conditions is not satisfied, contact your Endress+Hauser Sales Center.
- Depending on the device version, the CD-ROM might not be part of the delivery! The Technical Documentation is available via the Internet or via the *Endress+Hauser Operations App*.

### 3.2 Product identification

The following options are available for identification of the measuring device:

- Nameplate specifications
- Order code with breakdown of the device features on the delivery note
- Enter serial numbers from nameplates in *W@M Device Viewer* ([www.endress.com/deviceviewer](http://www.endress.com/deviceviewer)): All information about the measuring device is displayed.
- Enter the serial number from the nameplates into the *Endress+Hauser Operations App* or scan the 2-D matrix code (QR code) on the nameplate with the *Endress+Hauser Operations App*: all the information for the measuring device is displayed.

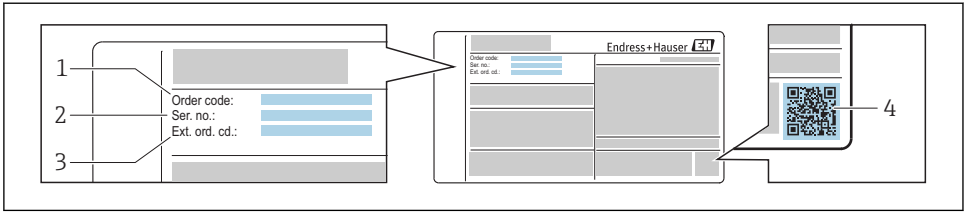

A0030196

### 1 Example of a nameplate

- 1 Order code
- 2 Serial number (Ser. no.)
- 3 Extended order code (Ext. ord. cd.)
- 4 2-D matrix code (QR code)



For detailed information on the breakdown of the specifications on the nameplate, see the Operating Instructions for the device .

## 4 Storage and transport

### 4.1 Storage conditions

Observe the following notes for storage:

- ▶ Store in the original packaging to ensure protection from shock.
- ▶ Do not remove protective covers or protective caps installed on process connections. They prevent mechanical damage to the sealing surfaces and contamination in the measuring tube.
- ▶ Protect from direct sunlight to avoid unacceptably high surface temperatures.
- ▶ Store in a dry and dust-free place.
- ▶ Do not store outdoors.

### 4.2 Transporting the product

Transport the measuring device to the measuring point in the original packaging.

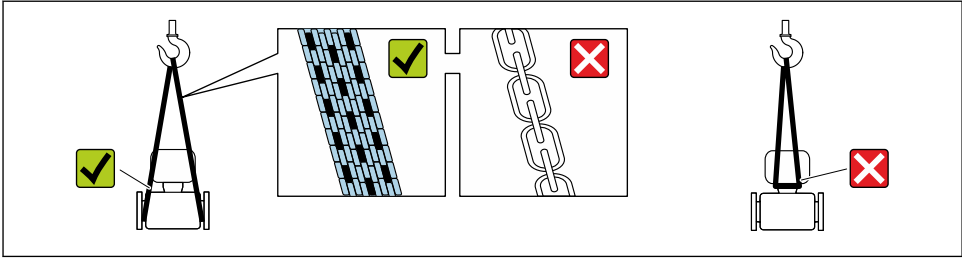

A0029252

**i** Do not remove protective covers or caps installed on process connections. They prevent mechanical damage to the sealing surfaces and contamination in the measuring tube.

#### 4.2.1 Measuring devices without lifting lugs

##### **⚠ WARNING**

**Center of gravity of the measuring device is higher than the suspension points of the webbing slings.**

Risk of injury if the measuring device slips.

- ▶ Secure the measuring device against slipping or turning.
- ▶ Observe the weight specified on the packaging (stick-on label).

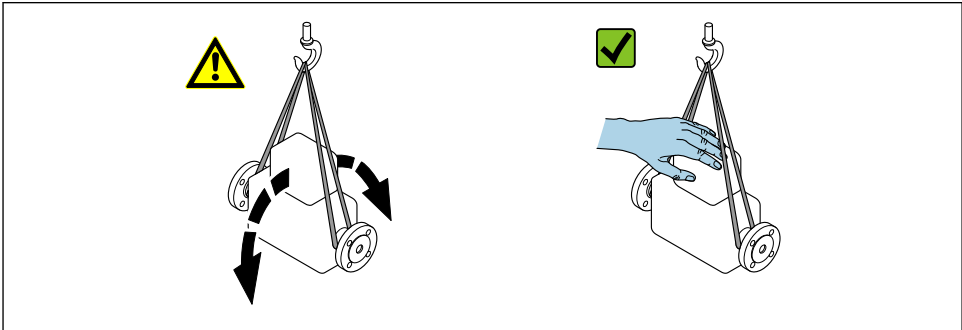

A0029214

#### 4.2.2 Measuring devices with lifting lugs

##### **⚠ CAUTION**

**Special transportation instructions for devices with lifting lugs**

- ▶ Only use the lifting lugs fitted on the device or flanges to transport the device.
- ▶ The device must always be secured at two lifting lugs at least.

#### 4.2.3 Transporting with a fork lift

If transporting in wood crates, the floor structure enables the crates to be lifted lengthwise or at both sides using a forklift.

## 5 Installation

### 5.1 Installation conditions

No special measures such as supports are necessary. External forces are absorbed by the construction of the device.

#### 5.1.1 Mounting position

##### Mounting location

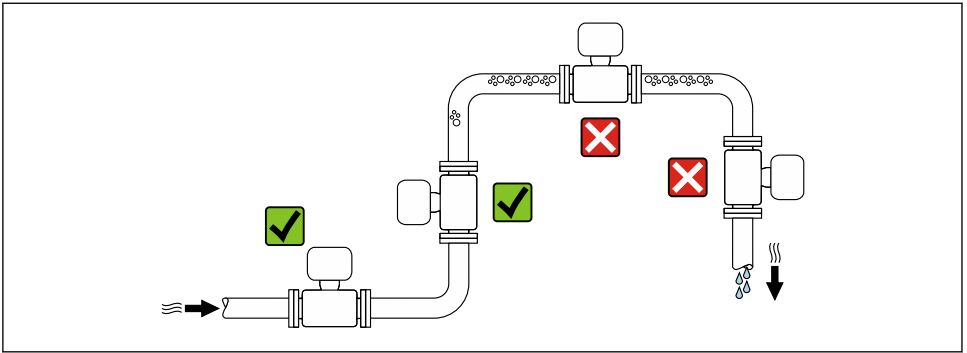

A0028772

##### *Installation in down pipes*

However, the following installation suggestion allows for installation in an open vertical pipeline. Pipe restrictions or the use of an orifice with a smaller cross-section than the nominal diameter prevent the sensor running empty while measurement is in progress.

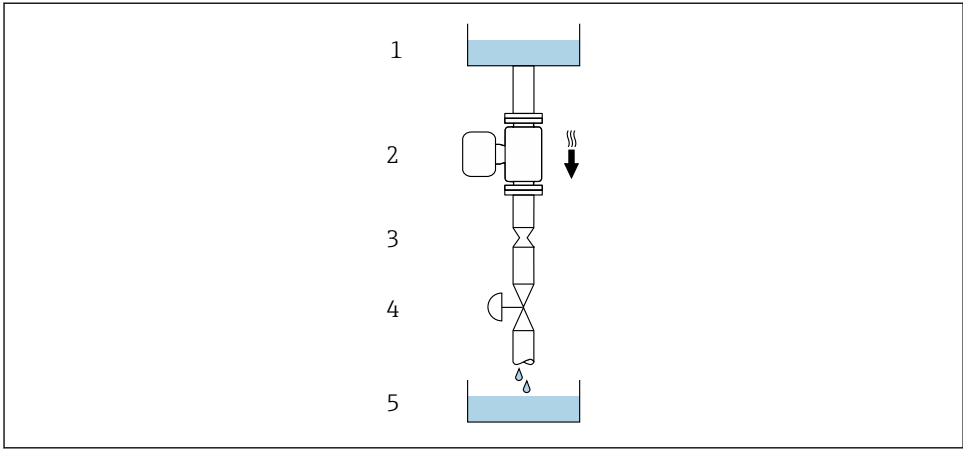

A0028773

2 Installation in a down pipe (e.g. for batching applications)

- 1 Supply tank
- 2 Sensor
- 3 Orifice plate, pipe restriction
- 4 Valve
- 5 Batching tank







DN		Ø orifice plate, pipe restriction	
[mm]	[in]	[mm]	[in]
1	1/24	0,8	0,03
2	1/12	1,5	0,06
4	1/8	3,0	0,12
8	3/8	6	0,24
15	1/2	10	0,40
15 FB	1/2 FB	15	0,60
25	1	14	0,55
25 FB	1 FB	24	0,95
40	1 1/2	22	0,87
40 FB	1 1/2 FB	35	1,38
50	2	28	1,10
50 FB	2 FB	54	2,13
80	3	50	1,97
100	4	65	2,60

DN		Ø orifice plate, pipe restriction	
[mm]	[in]	[mm]	[in]
150	6	90	3,54
250	10	150	5,91
300	12	210	8,27
350	14	210	8,27
400	16	210	8,27

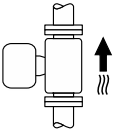
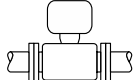
FB = Full bore

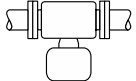
### Orientation

The direction of the arrow on the sensor nameplate helps you to install the sensor according to the flow direction.

Orientation		Recommendation
<b>A</b>	Vertical orientation	 <small>A0015591</small> <input checked="" type="checkbox"/> <input checked="" type="checkbox"/>
<b>B</b>	Horizontal orientation, transmitter at top	 <small>A0015589</small> <input checked="" type="checkbox"/> <input checked="" type="checkbox"/> <sup>1)</sup> Exceptions: →  ,  16
<b>C</b>	Horizontal orientation, transmitter at bottom	 <small>A0015590</small> <input checked="" type="checkbox"/> <input checked="" type="checkbox"/> <sup>2)</sup> Exceptions: →  ,  16
<b>D</b>	Horizontal orientation, transmitter at side	 <small>A0015592</small> <input checked="" type="checkbox"/> <input checked="" type="checkbox"/> <sup>5)</sup> <input checked="" type="checkbox"/> <sup>4)</sup> <input checked="" type="checkbox"/> <input checked="" type="checkbox"/> <sup>3)</sup>

- 1) Applications with low process temperatures may decrease the ambient temperature. To maintain the minimum ambient temperature for the transmitter, this orientation is recommended.
- 2) Applications with high process temperatures may increase the ambient temperature. To maintain the maximum ambient temperature for the transmitter, this orientation is recommended.
- 3) Promass A, E, F, G, O
- 4) Promass X
- 5) Promass H, I, P, Q, S

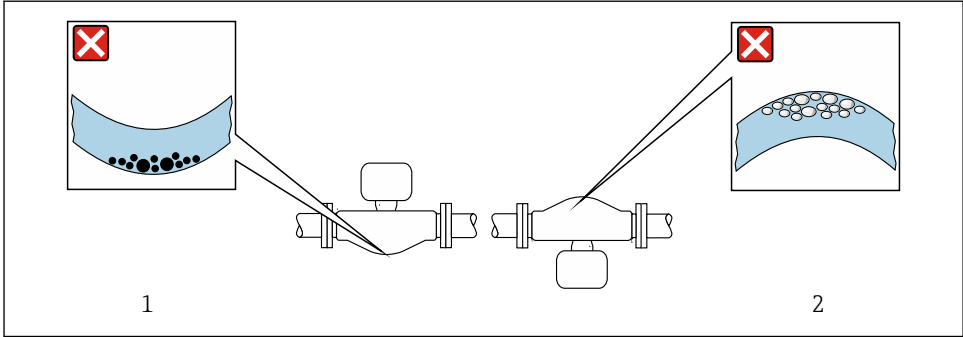

A0028774

**3** Orientation of sensor with curved measuring tube

- 1 Avoid this orientation for fluids with entrained solids: Risk of solids accumulating.
- 2 Avoid this orientation for outgassing fluids: Risk of gas accumulating.

**Inlet and outlet runs**

No special precautions need to be taken for fittings which create turbulence, such as valves, elbows or T-pieces, as long as no cavitation occurs → 17.

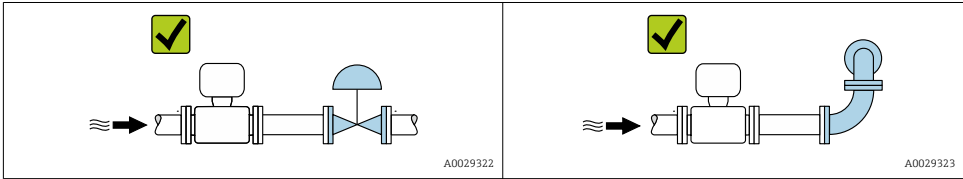

**1** For the dimensions and installation lengths of the device, see the "Technical Information" document, "Mechanical construction" section

**5.1.2 Requirements from environment and process**

**Ambient temperature range**

**1** For detailed information on the ambient temperature range, see the Operating Instructions for the device.

If operating outdoors:  
Avoid direct sunlight, particularly in warm climatic regions.

*Temperature tables*

**1** For detailed information on the temperature tables, see the separate document entitled "Safety Instructions" (XA) for the device.



## System pressure

For this reason, the following mounting locations are recommended:

- At the lowest point in a vertical pipe
- Downstream from pumps (no danger of vacuum)

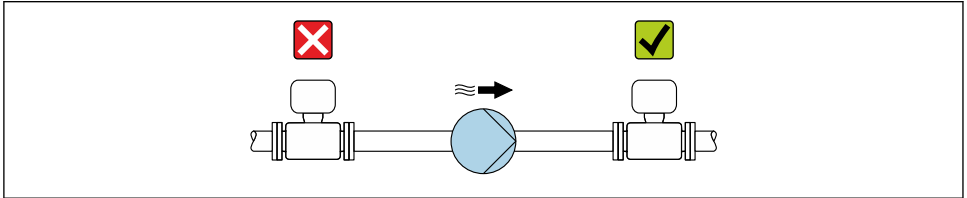

A002&amp;777

## Thermal insulation

In the case of some fluids, it is important that the heat radiated from the sensor to the transmitter is kept to a minimum. A wide range of materials can be used for the required insulation.

### NOTICE

#### Electronics overheating on account of thermal insulation!

- ▶ Observe maximum permitted insulation height of the transmitter neck so that the transmitter head is completely free.

### NOTICE

#### Danger of overheating with insulation

- ▶ Ensure that the temperature at the lower end of the transmitter housing sensor housing does not exceed 80 °C (176 °F)

### NOTICE

#### The insulation can also be thicker than the maximum recommended insulation thickness.

Prerequisite:

- ▶ Ensure that convection takes place on a sufficiently large scale at the transmitter neck.
- ▶ Ensure that a sufficiently large area of the housing support remains exposed. The uncovered part serves as a radiator and protects the electronics from overheating and excessive cooling.

Promass 100, 300, 500

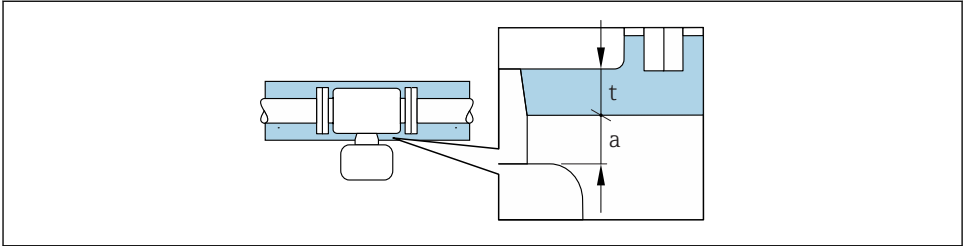

A0028853

- a Minimum distance to insulation
- t maximum Insulation thickness

The minimum distance a between the transmitter sensor connection housing and the insulation is 10 mm (0,39 in) 20 mm (0,79 in). This is to ensure that the transmitter sensor connection housing remains completely exposed.

Maximum recommended insulation thickness

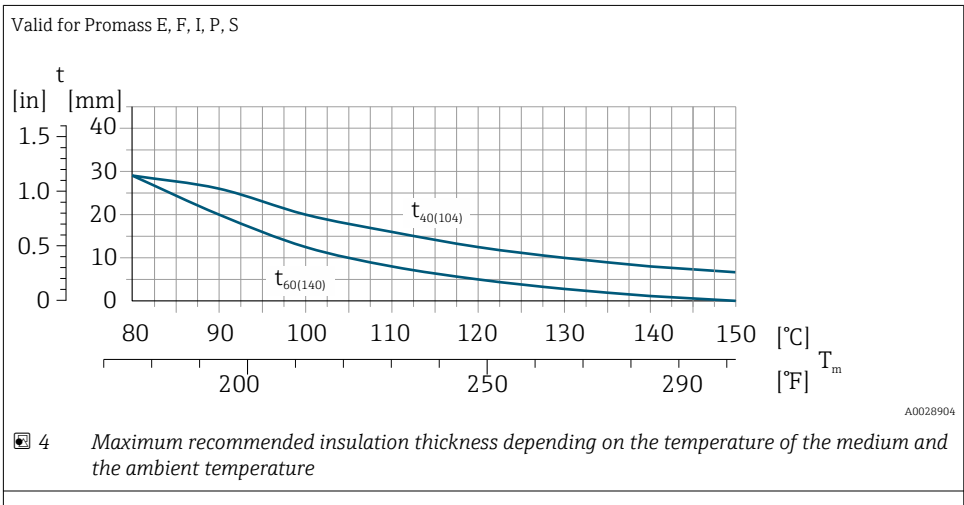

A0028904

Maximum recommended insulation thickness depending on the medium temperature and ambient temperature for the extended temperature range or insulation

Promass F: For the extended temperature range, version with long extension neck, order code for "Measuring tube material", option SD, SE, SF, TH or extension neck for insulation, order code for "Sensor option", option CG

Promass P: For the extended temperature range, version with long extension neck, order code for "Measuring tube material", option TD, TG or extension neck for insulation, order code for "Sensor option", option CG

Promass I and S: For the version extension neck for insulation order code for "Sensor option", option CG

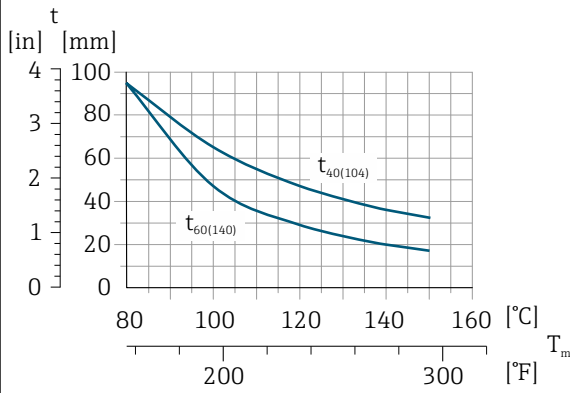

A0029981

5 Valid for Promass I, S

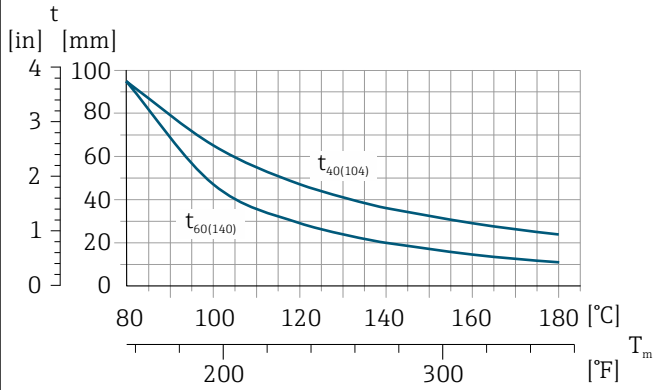

A0029990

6 Valid for Promass X

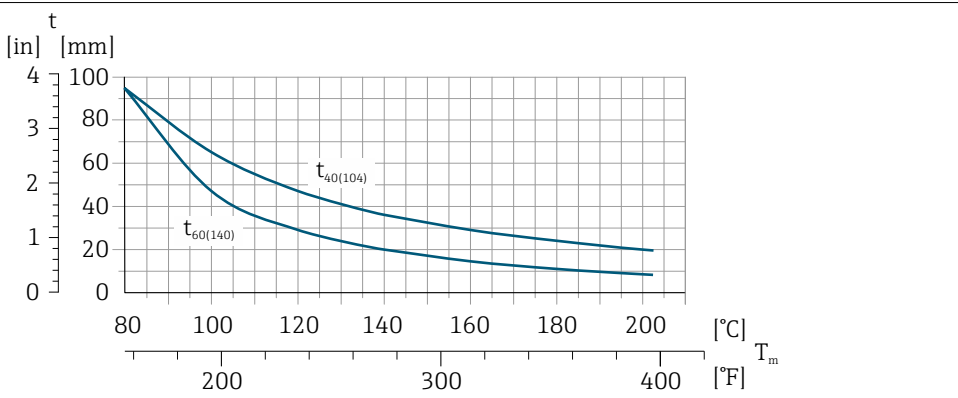

A0029921

7 Valid for Promass A, H, O, P, Q

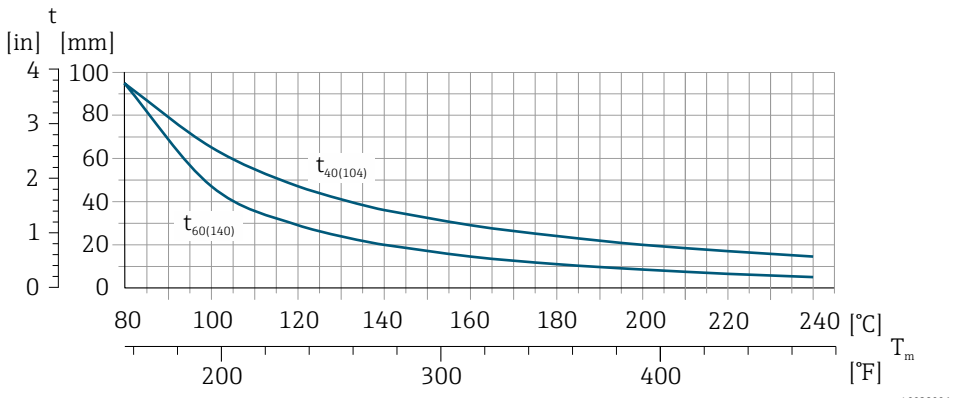

A0028906

8 Valid for Promass F

$t$  Insulation thickness

$T_m$  Medium temperature

$T_{40(104)}$  Maximum recommended insulation thickness at an ambient temperature of  $T_a = 40\text{ °C}$  (104 °F)

$T_{60(140)}$  Maximum recommended insulation thickness at an ambient temperature of  $T_a = 60\text{ °C}$  (140 °F)

Maximum recommended insulation thickness for the high-temperature range

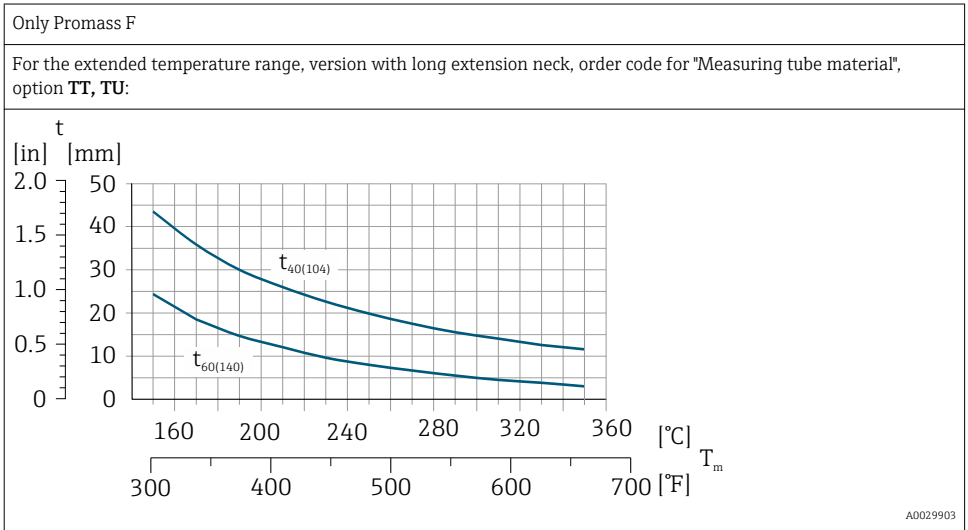

- $t$  Insulation thickness
- $T_m$  Medium temperature
- $t_{40(104)}$  Maximum recommended insulation thickness at an ambient temperature of  $T_a = 40\text{ °C}$  ( $104\text{ °F}$ )
- $t_{60(140)}$  Maximum recommended insulation thickness at an ambient temperature of  $T_a = 60\text{ °C}$  ( $140\text{ °F}$ )

Promass 200

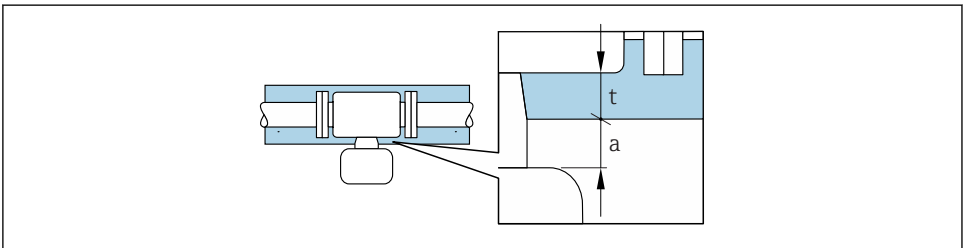

- $a$  Minimum distance to insulation
- $t$  maximum Insulation thickness

The minimum distance  $a$  between the transmitter sensor connection housing and the insulation is 10 mm (0,39 in) 20 mm (0,79 in). This is to ensure that the transmitter sensor connection housing remains completely exposed.

## Heating

### NOTICE

#### Electronics can overheat due to elevated ambient temperature!

- ▶ Observe maximum permitted ambient temperature for the transmitter .
- ▶ Depending on the fluid temperature, take the device orientation requirements into account .



Under critical climatic conditions, in particular, it is important to ensure that the temperature difference between the ambient temperature and the fluid temperature is not >100 K. Suitable measures must be taken, such as heating or insulation.

### NOTICE

#### Danger of overheating when heating

- ▶ Ensure that the temperature at the lower end of the transmitter housing does not exceed 80 °C (176 °F).
- ▶ Ensure that convection takes place on a sufficiently large scale at the transmitter neck.
- ▶ Ensure that a sufficiently large area of the housing support remains exposed. The uncovered part serves as a radiator and protects the electronics from overheating and excessive cooling.

#### Heating options

If a fluid requires that no heat loss should occur at the sensor, users can avail of the following heating options:

- Electrical heating, e.g. with electric band heaters
- Via pipes carrying hot water or steam
- Via heating jackets



For detailed information about heating with electrical band heaters, refer to the Operating Instructions for the device on the CD-ROM provided

## Vibrations

The high oscillation frequency of the measuring tubes ensures that the correct operation of the measuring system is not influenced by plant vibrations.

The operational reliability of the measuring system is not affected by plant vibrations.

### 5.1.3 Special mounting instructions

#### Rupture disk

- ▶ After the rupture disk is actuated, do not operate the measuring device any more.



For detailed information about using a rupture disk, refer to the Operating Instructions for the device on the CD-ROM provided

#### Promass A, F, O, Q

Make sure that the function and operation of the rupture disk is not impeded through the installation of the device. The position of the rupture disk is indicated on a sticker beside it.

The transportation guard must be removed.

The existing connecting nozzles are not intended for the purpose of rinsing or pressure monitoring, but instead serve as the mounting location for the rupture disk.

In the event of a failure of the rupture disk, a discharge device can be screwed onto the internal thread of the rupture disk in order to drain off any escaping medium.

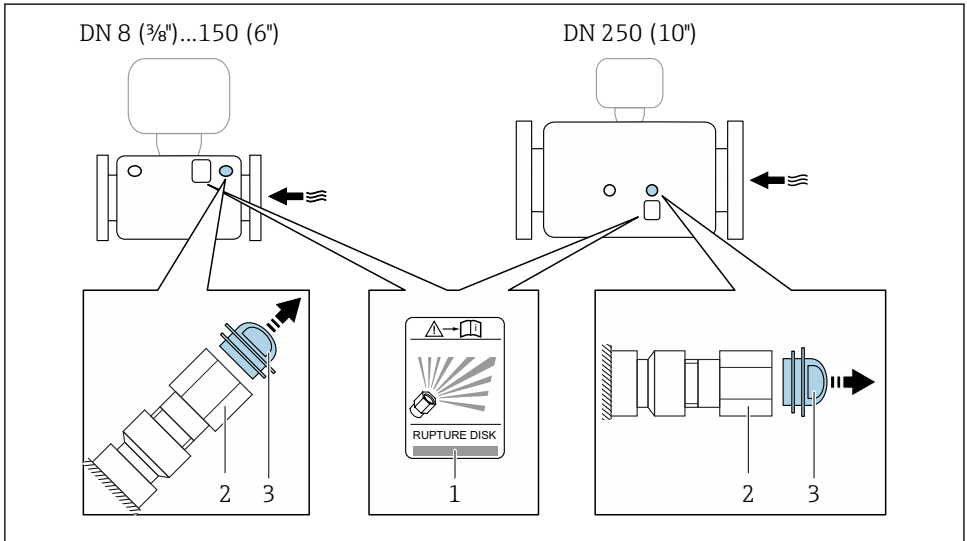

A0028903

- 1 Rupture disk label
- 2 Rupture disk with 1/2" NPT internal thread with 1" width across flat
- 3 Transport protection



For information on the dimensions: see the "Mechanical construction" section of the "Technical Information" document

### Promass E

Make sure that the function and operation of the rupture disk is not impeded through the installation of the device. The position of the rupture disk is indicated on a sticker applied over it. If the rupture disk is triggered, the sticker is destroyed. The disk can therefore be visually monitored.

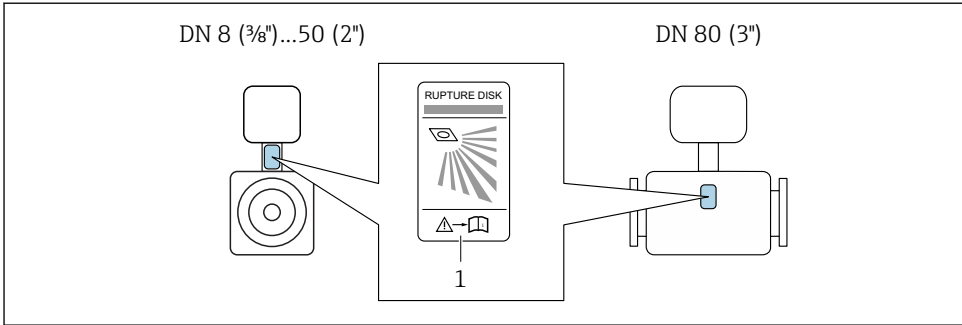

A0029956

### 9 Rupture disk label

#### PromassG

Make sure that the function and operation of the rupture disk is not impeded through the installation of the device. The position of the rupture disk is indicated on a sticker applied over it. If the rupture disk is triggered, the sticker is destroyed. The disk can therefore be visually monitored.

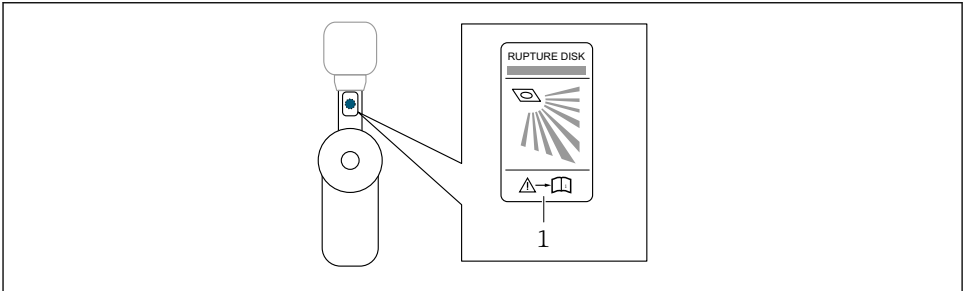

A0030005

#### Promass X

Make sure that the function and operation of the rupture disk is not impeded through the installation of the device. The position of the rupture disk is indicated on a sticker beside it.

The transportation guard must be removed.

The existing connecting nozzles are not intended for the purpose of rinsing or pressure monitoring, but instead serve as the mounting location for the rupture disk.

In the event of a failure of the rupture disk, a discharge device can be screwed onto the internal thread of the rupture disk in order to drain off any escaping medium.



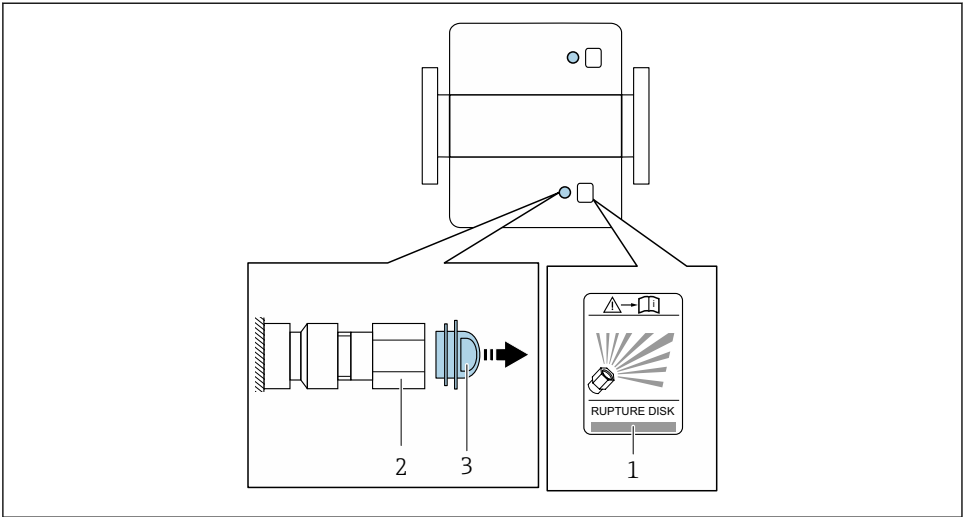

A0029944

- 1 Rupture disk label
- 2 Rupture disk with 1/2" NPT internal thread with 1" width across flat
- 3 Transport protection



For information on the dimensions: see the "Mechanical construction" section of the "Technical Information" document

**Securing with mounting clamps for hygiene connections(Promass I, P, S)**

It is not necessary to provide additional support for the sensor for operational performance purposes. If, however, additional support is required for installation purposes, the following dimensions must be observed.

Use mounting clamp with lining between clamp and measuring instrument.

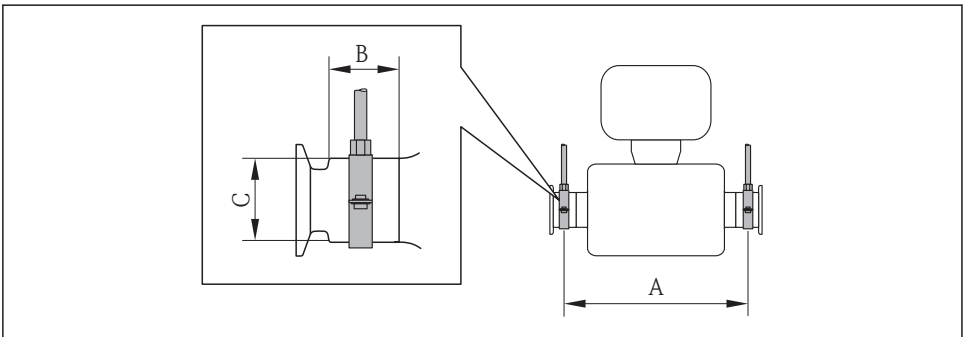

A0016588

*Promass P, S*

DN		A		B		C	
[mm]	[in]	[mm]	[in]	[mm]	[in]	[mm]	[in]
8	$\frac{3}{8}$	298	11,73	33	1,3	28	1,1
15	$\frac{1}{2}$	402	15,83	33	1,3	28	1,1
25	1	542	21,34	33	1,3	38	1,5
40	1 $\frac{1}{2}$	658	25,91	36,5	1,44	56	2,2
50	2	772	30,39	44,1	1,74	75	2,95

*Promass I*

DN		A		B		C	
[mm]	[in]	[mm]	[in]	[mm]	[in]	[mm]	[in]
8	8	373	14,69	20	0,79	40	1,57
15	15	409	16,1	20	0,79	40	1,57
15 FB	15 FB	539	21,22	30	1,18	44,5	1,75
25	25	539	21,22	30	1,18	44,5	1,75
25 FB	25 FB	668	26,3	28	1,1	60	2,36
40	40	668	26,3	28	1,1	60	2,36
40 FB	40 FB	780	30,71	35	1,38	80	3,15
50	50	780	30,71	35	1,38	80	3,15
50 FB	50 FB	1152	45,35	57	2,24	90	3,54
80	80	1152	45,35	57	2,24	90	3,54

**Complete drainability guaranteed (Promass I, P)**

When the sensor is installed in a horizontal line, eccentric clamps can be used to ensure complete drainability. When the system is pitched in a specific direction and at a specific slope, gravity can be used to achieve complete drainability. The sensor must be mounted in the correct position to ensure full drainability in the horizontal position. Markings on the sensor show the correct mounting position to optimize drainability.

*Promass I*

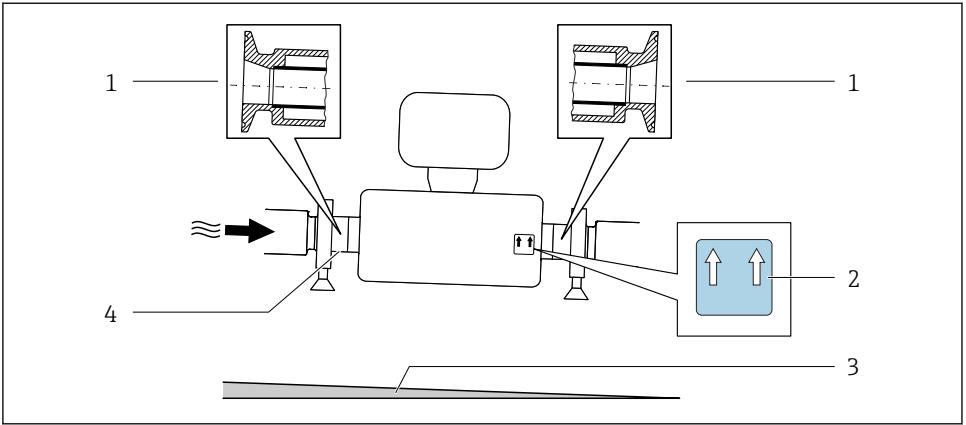

A0030297

- 1 Eccentric clamp connection
- 2 "This side up" label indicates which side is up
- 3 Slope the device in accordance with the hygiene guidelines. Slope: approx. 2 % or 21 mm/m (0.24 in/feet)
- 4 Line on the underside indicates the lowest point of the eccentric process connection.

Promass P

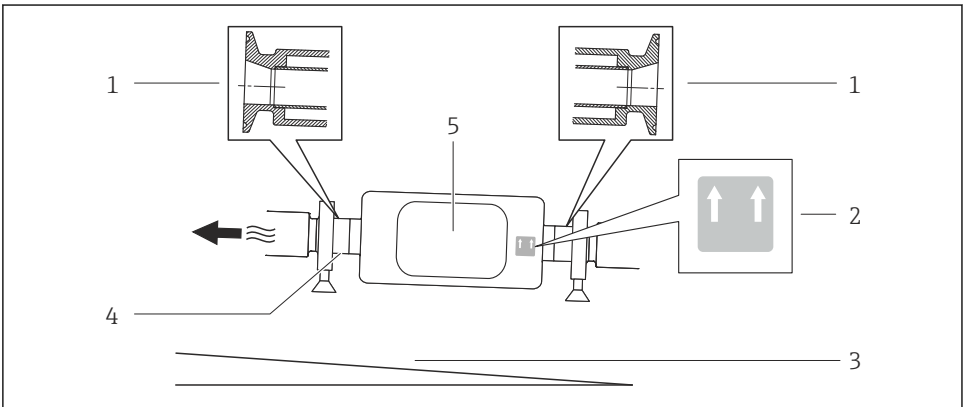

A0016583

- 1 Eccentric clamp connection
- 2 "This side up" label indicates which side is up
- 3 Slope the device in accordance with the hygiene guidelines. Slope: approx. 2 ° or 35 mm/m (0.42 in/feet)
- 4 Line on the underside indicates the lowest point of the eccentric process connection.
- 5 Transmitter

## Wall and floor mounting (Promass A)

### **⚠ WARNING**

#### **Incorrect sensor mounting**

Risk of injury if measuring tube breaks

- ▶ The sensor should never be installed in a pipe in a way that it is freely suspended
- ▶ Using the base plate, mount the sensor directly on the floor, wall or ceiling.
- ▶ Support the sensor on a securely mounted support base (e.g. angle bracket).

The following mounting versions are recommended for the installation.

#### Vertical

- Mounted directly on a wall using the base plate, or
- Device supported on an angle bracket mounted on the wall

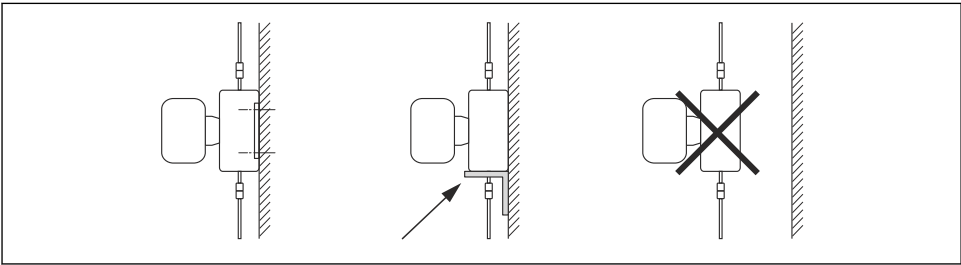

A0019631

#### Horizontal

Device standing on a solid support base

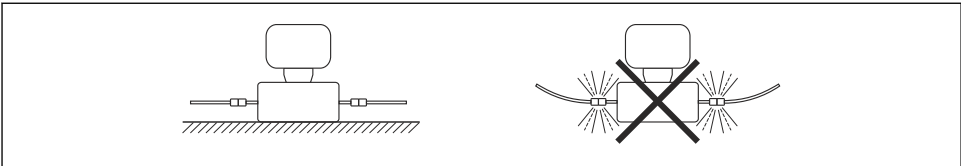

A0019632

## Post retainer (Promass A)

The post retainer mounting kit is used to secure the device to a pipe or post (order code for "Accessories", option PR).

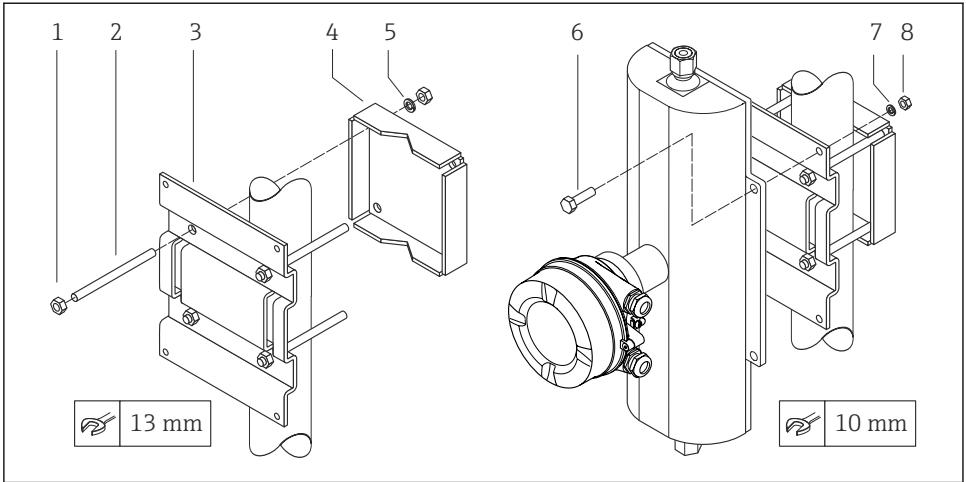

A0019746

#### 10 Post retainer mounting kit

- 1 8 x hexagonal nut M8 × 0.8
- 2 4 x threaded bolt M8 × 150
- 3 1 x post retaining plate
- 4 1 x post securing plate
- 5 4 x spring washer M8
- 6 4 x hexagon bolt M6 × 20
- 7 4 x spring washer M6
- 8 4 x hexagonal nut M6 × 0.8

### Zero point adjustment

All measuring devices are calibrated in accordance with state-of-the-art technology. Calibration takes place under reference conditions. Therefore, a zero point adjustment in the field is generally not required.

Experience shows that zero point adjustment is advisable only in special cases:

- To achieve maximum measuring accuracy even with low flow rates
- Under extreme process or operating conditions (e.g. very high process temperatures or very high-viscosity fluids).

## 5.2 Mounting the measuring device

### 5.2.1 Required tools

#### For transmitter

- For turning the transmitter housing: Open-ended wrench 8 mm
- For opening the securing clamps: Allen key 3 mm
- For turning the transmitter housing: Open-ended wrench 8 mm
- For opening the securing clamps: Allen key 3 mm

For mounting on a post:

- Proline 500 – digital transmitter
  - Open-ended wrench AF 10
  - Torx screwdriver TX 25
- Proline 500 transmitter
  - Open-ended wrench AF 13

For wall mounting:

Drill with drill bit  $\varnothing$  6.0 mm

### For sensor

For flanges and other process connections: Corresponding mounting tools

#### 5.2.2 Preparing the measuring device

1. Remove all remaining transport packaging.
2. Remove any protective covers or protective caps present from the sensor.
3. If present, remove transport protection of the rupture disk.
4. Remove stick-on label on the electronics compartment cover.

#### 5.2.3 Mounting the measuring device

##### **⚠ WARNING**

##### **Danger due to improper process sealing!**

- ▶ Ensure that the inside diameters of the gaskets are greater than or equal to that of the process connections and piping.
- ▶ Ensure that the gaskets are clean and undamaged.
- ▶ Install the gaskets correctly.

1. Ensure that the direction of the arrow on the nameplate of the sensor matches the flow direction of the fluid.
2. Install the measuring device or turn the transmitter housing so that the cable entries do not point upwards.

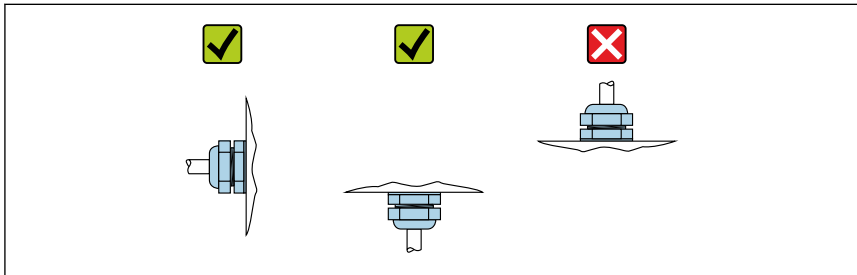

A0029263

## 5.3 Post-installation check

Is the device undamaged (visual inspection)?	<input type="checkbox"/>
Does the measuring device conform to the measuring point specifications? For example: <ul style="list-style-type: none"> <li>▪ Process temperature</li> <li>▪ Process pressure (refer to the chapter on "Pressure-temperature ratings" of the "Technical Information" document on the CD-ROM provided)</li> <li>▪ Ambient temperature</li> <li>▪ Measuring range</li> </ul>	<input type="checkbox"/>
Has the correct orientation for the sensor been selected ? <ul style="list-style-type: none"> <li>▪ According to sensor type</li> <li>▪ According to medium temperature</li> <li>▪ According to medium properties (outgassing, with entrained solids)</li> </ul>	<input type="checkbox"/>
Does the arrow on the sensor nameplate match the direction of flow of the fluid through the piping →  15?	<input type="checkbox"/>
Are the measuring point identification and labeling correct (visual inspection)?	<input type="checkbox"/>
Is the device adequately protected from precipitation and direct sunlight?	<input type="checkbox"/>
Are the securing screw and securing clamp tightened securely?	<input type="checkbox"/>

## 6 Disposal

### 6.1 Removing the measuring device

1. Switch off the device.

#### **WARNING**

#### **Danger to persons from process conditions.**

- ▶ Beware of hazardous process conditions such as pressure in the measuring device, high temperatures or aggressive fluids.

2. Carry out the mounting and connection steps from the "Mounting the measuring device" and "Connecting the measuring device" sections in reverse order. Observe the safety instructions.

### 6.2 Disposing of the measuring device

#### **WARNING**

#### **Danger to personnel and environment from fluids that are hazardous to health.**

- ▶ Ensure that the measuring device and all cavities are free of fluid residues that are hazardous to health or the environment, e.g. substances that have permeated into crevices or diffused through plastic.

Observe the following notes during disposal:

- ▶ Observe valid federal/national regulations.
- ▶ Ensure proper separation and reuse of the device components.

[www.addresses.endress.com](http://www.addresses.endress.com)

---