

Safety Instructions

Gammapilot M FMG60

4-20 mA HART

Ex de [ia Ga] IIC T6 Gb

Ex d [ia Ga] IIC T6 Gb

TÜV 13.0916



Document: XA01333F-A

Safety instructions for electrical apparatus for explosion-hazardous areas

Gammapilot M FMG60

4-20 mA HART

Associated Documentation

This document is an integral part of the following Operating Instructions:
BA00236F/00

The Operating Instructions which are supplied and correspond to the device type apply.

Supplementary Documentation

Explosion-protection brochure:
CP00021Z/11

Designation

Explanation of the labelling and type of protection can be found in the explosion protection brochure.

Designation of type of protection

Ex de [ia Ga] IIC T6 Gb
Ex d [ia Ga] IIC T6 Gb

Applied standards

ABNT NBR IEC 60079-0 :2008
ABNT NBR IEC 60079-1 :2009
ABNT NBR IEC 60079-7 :2008
ABNT NBR IEC 60079-11 :2009
ABNT NBR IEC 60079-26 :2008

Circuit 4...20 mA/HART (active) in type of protection Intrinsic Safety "ia"

Type:

FMG60-**B1*****, FMG60-**E1*****, FMG60-**J1*****, FMG60-**K1*****,
FMG60-**L1*****

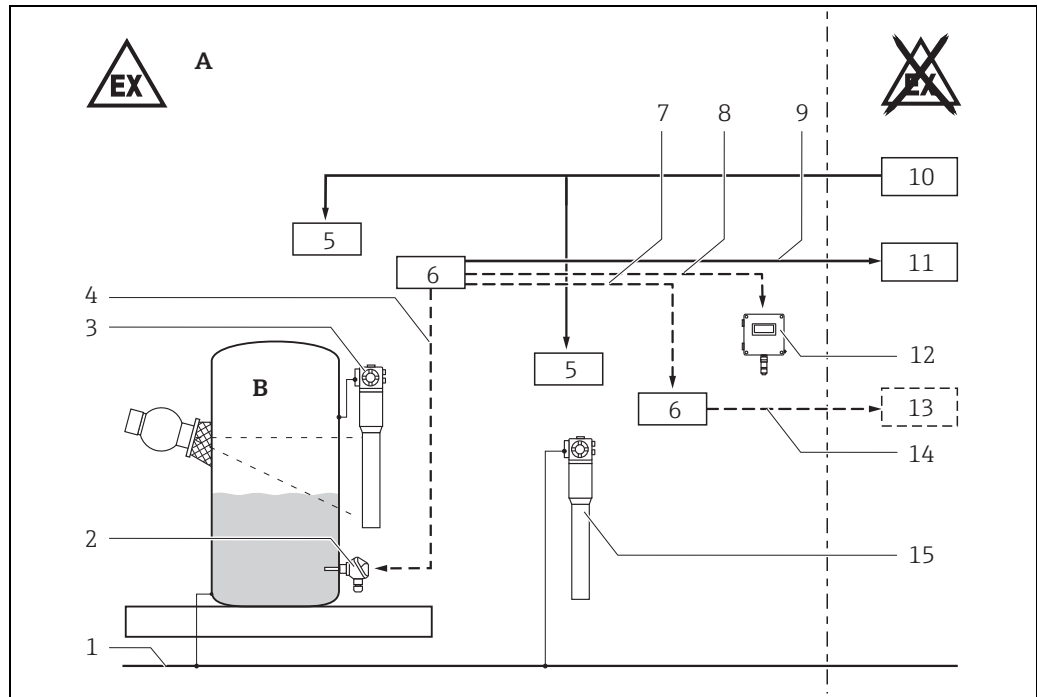

FMG60_03



- A** Zone 1 or Zone 2
- B** Zone 0 or Zone 1
- 1 Local potential equalization line
- 2 PT100; certified apparatus
- 3 Gammapilot with NaJ crystal scintillator, PVT plastic scintillator
- 4 [Ex ia] circuit
- 5 Terminal compartment A (Ex d or Ex e)
- 6 Terminal compartment B (Ex i)
- 7 [Ex ia] circuit; Cascade in, out
- 8 [Ex ia] circuit
- 9 Communication: 4...20 mA/HART active [Ex ia]
- 10 Power supply
- 11 Certified associated apparatus
- 12 Remote display FHX40
- 13 Certified associated apparatus
- 14 Communication: 4...20 mA/HART active [Ex ia]
- 15 Gammapilot with NaJ crystal scintillator, PVT plastic scintillator

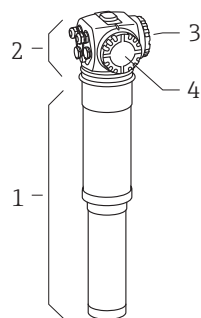

- 1 Pipe housing
- 2 Compartment housing
- 3 Terminal compartment A
- 4 Terminal compartment B

Circuit 4...20 mA/HART (active) in type of protection Increased Safety "e" or Flameproof Enclosure "d"

Type:

FMG60-**C1****, FMG60-**D1****, FMG60-**G1****, FMG60-**H1****

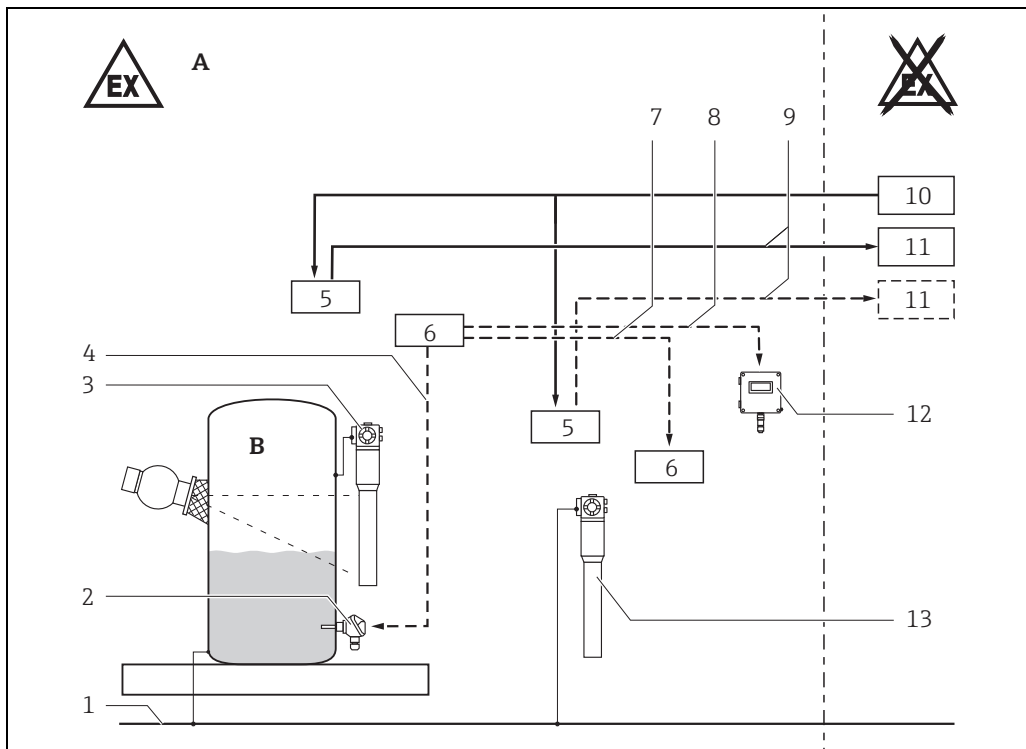

- A** Zone 1 or Zone 2
- B** Zone 0 or Zone 1
- 1 Local potential equalization line
- 2 PT100; certified apparatus
- 3 Gammapilot with NaJ crystal scintillator, PVT plastic scintillator
- 4 [Ex ia] circuit
- 5 Terminal compartment A (Ex d or Ex e)
- 6 Terminal compartment B (Ex i)
- 7 [Ex ia] circuit; Cascade in, out
- 8 [Ex ia] circuit
- 9 Communication: 4...20 mA/HART active
- 10 Power supply
- 11 E.g. transmitter
- 12 Remote display FHX40
- 13 Gammapilot with NaJ crystal scintillator, PVT plastic scintillator

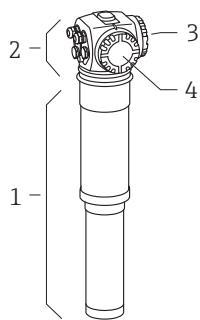

- 1 Pipe housing
- 2 Compartment housing
- 3 Terminal compartment A
- 4 Terminal compartment B

**Safety instructions:
Installation**

- Comply with the installation and safety instructions in the Operating Instructions.
- Install the device according to the manufacturer's instructions and any other valid standards and regulations.
- Do not operate the device outside the specified electrical, thermal and mechanical parameters.
- To maintain the ingress protection of the housing IP65/IP67, install the housing cover, cable glands and blind plugs correctly.
- Connect the apparatus to the on-site potential equalization line.
- Cable glands as well as sealing plugs of the terminal compartment A must not be exchanged with those of the terminal compartment B.
- Do not open the terminal compartment A when energized.
- In an explosive atmosphere: Minimum waiting time before opening the terminal compartment A after switching off the power supply: 3 minutes.
- During operation, the covers must be screwed all the way in and the safety catch of cover must be fastened.
- The safety screws at the pipe housing must not be loosened:

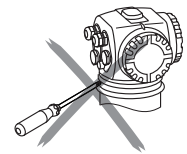

When using the water cooling

- Use connecting cables for continuous service temperature $T \geq T_a + 5 \text{ K}$.

Avoid electrostatic charging

- In case of additional or alternative special varnishing of the enclosure or other metallic parts:
 - Do not rub the surfaces dry.
 - Do not install in the vicinity of processes generating strong electrostatic charges.
- Avoid electrostatic charging:
 - Of plastic surfaces (e.g. housing, sensor element, special varnishing, attached additional plates, ..)
 - Of isolated capacities (e.g. isolated metallic plates)

**Power supply
in type of protection
Increased Safety "e"**

- Only use suitable certified Ex e cable glands providing an ingress protection rating of at least IP65/IP67, which are suitable for the intended ambient temperature range.
- Replace cable glands and sealing plugs only with identical parts.

**Power supply
in type of protection
Flameproof Enclosure "d"**

- Connect the device using suitable certified Ex d cable glands or using conduit systems of protection type Flameproof Enclosure "d".
- Close unused entry glands with approved Ex d sealing plugs.

**Signal circuit
in type of protection
Intrinsic Safety "ia"**

- The pertinent guidelines must be observed when intrinsically safe circuits are connected together (Proof of Intrinsic Safety).
- The intrinsically safe circuits are galvanically isolated from other circuits up to a peak value of the nominal voltage of 375 V.
- The intrinsically safe circuits of the device are isolated from ground potential and have a dielectric strength of at least $500 \text{ V}_{\text{rms}}$ with respect to it.
- When the device is connected to an intrinsically safe circuit Ex ib, the type of protection changes to Ex ib. Do not operate the temperature sensor in Zone 0 if the device is connected to an intrinsically safe circuit of Category Ex ib.
- Do not interconnect the 4...20 mA/HART signal circuits of the devices of a cascade set.

Temperature tables

Temperature class	
T6	

Gammapilot with NaJ crystal scintillator or PVT plastic scintillator:

Ambient temperature	
Detector without water cooling or detector with water cooling out of operation:	<ul style="list-style-type: none"> Devices with NaJ crystal scintillator: $-40\text{ °C} \leq T_a \leq +60\text{ °C}$ Devices with PVT plastic scintillator: $-40\text{ °C} \leq T_a \leq +60\text{ °C}$
Detector with water cooling in operation:	
At the pipe housing (within the water cooling):	
<ul style="list-style-type: none"> Devices with NaJ crystal scintillator: $-40\text{ °C} \leq T_a \leq +60\text{ °C}$ Devices with PVT plastic scintillator: $-40\text{ °C} \leq T_a \leq +60\text{ °C}$ 	
At the compartment housing:	$-40\text{ °C} \leq T_a \leq +80\text{ °C}$

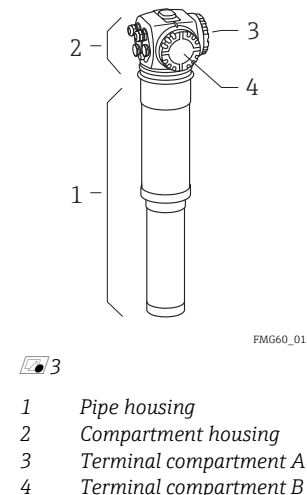

Type of protection	
Power supply circuit (Terminal compartment A)	Ex e or Ex d
Signal circuits (Terminal compartment B)	Ex ia

Connection data

Terminal compartment A

Increased Safety "e" or Flameproof Enclosure "d"

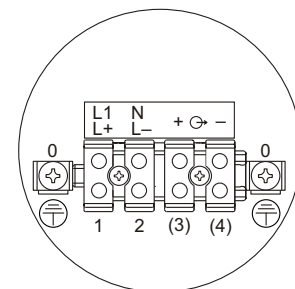

Power supply circuit		
Type AC-power supply FMG60-*1*****	L1 N	$U_e = 90...253\text{ VAC}, 50/60\text{ Hz}, 8.5\text{ VA}$
Type DC-power supply FMG60-*2*****	L+ L-	$U_e = 18...36\text{ VDC}, 3.5\text{ W}$ $U_m = 253\text{ VAC}$

Signal circuit		
FMG60-**B1***** FMG60-**E1***** FMG60-**J1***** FMG60-**K1***** FMG60-**L1*****	⊖ → + -	not connected
FMG60-**C1***** FMG60-**G1***** FMG60-**D1***** FMG60-**H1***** FMG60-**F1*****	⊖ → + -	$4...20\text{ mA/HART (active)}$ $U_m = 253\text{ VAC}$ The detector ensures galvanic isolation up to a maximum of 253 VAC between the signal circuit and any other circuit.

Terminal compartment B

Intrinsic Safety "ia"

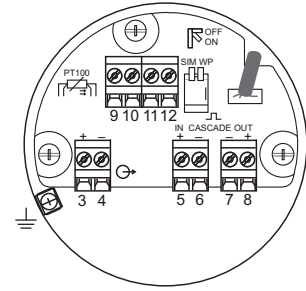

Signal circuit		Ex ia IIC	Ex ia IIB	Ex ib IIC	Ex ib IIB
4...20 mA/ HART (active) *1		$U_o = 21.2 \text{ V}$ $I_o = 92 \text{ mA}$ $P_o = 479 \text{ mW}$ $R_i = 235 \Omega$ $C_i = 13.4 \text{ nF}$ $L_i = 0$ Characteristic curve: linear $U_i = 30 \text{ V}$ $I_i = 13 \text{ mA}$ $P_i = 390 \text{ mW}$	$C_o = 150 \text{ nF}$ at $L_o = 0.15 \text{ mH}$ $C_o = 115 \text{ nF}$ at $L_o = 1 \text{ mH}$	$C_o = 886 \text{ nF}$ at $L_o = 0.15 \text{ mH}$ $C_o = 686 \text{ nF}$ at $L_o = 1 \text{ mH}$	$C_o = 169 \text{ nF}$ $L_o = 4 \text{ mH}$ $C_o = 1.2 \mu\text{F}$ $L_o = 15 \text{ mH}$
*1 only available at the versions: FMG60-**B1****, FMG60-**E1****, FMG60-**J1****, FMG60-**K1****, FMG60-**L1****.					
PT100		$U_o = 8.4 \text{ V}$ $I_o = 8.3 \text{ mA}$ $P_o = 17.5 \text{ mW}$ $R_i = 1012 \Omega$ $C_i = 0$ $L_i = 0$ Characteristic curve: linear	$C_o = 1200 \text{ nF}$ at $L_o = 1 \text{ mH}$ $C_o = 1800 \text{ nF}$ at $L_o = 0.15 \text{ mH}$	$C_o = 6 \mu\text{F}$ at $L_o = 1 \text{ mH}$ $C_o = 5.2 \mu\text{F}$ at $L_o = 2 \text{ mH}$	$C_o = 5.2 \mu\text{F}$ $L_o = 400 \text{ mH}$ $C_o = 43 \mu\text{F}$ $L_o = 400 \text{ mH}$
Cascade out		$U_o = 8.4 \text{ V}$ $I_o = 19.2 \text{ mA}$ $P_o = 40.3 \text{ mW}$ $R_i = 439 \Omega$ $C_i = 5.3 \text{ nF}$ $L_i = 67 \mu\text{H}$ Characteristic curve: linear	$C_o = 5.1 \mu\text{F}$ $L_o = 69 \text{ mH}$	$C_o = 42 \mu\text{F}$ $L_o = 199 \text{ mH}$	$C_o = 5.1 \mu\text{F}$ $L_o = 69 \text{ mH}$ $C_o = 42 \mu\text{F}$ $L_o = 199 \text{ mH}$
Only for connection to FMG60 signal circuit "Cascade in"					
Cascade in		$U_i = 8.4 \text{ V}$ $I_i = 19.2 \text{ mA}$ $P_i = 40.3 \text{ mW}$ $C_i = 0$ $L_i = 67 \mu\text{H}$			
Only for connection to FMG60 signal circuit "Cascade out"					
Connection for FHX40		$U_o = 4.7 \text{ V}$ $I_o = 37.7 \text{ mA}$ $P_o = 44.3 \text{ mW}$ $R_i = 125 \Omega$ $C_i = 12.7 \text{ nF}$ $L_i = 0$ Characteristic curve: linear	For connection to the approved display FHX40 with associated cable in type of protection Intrinsic Safety Ex ia IIC or IIB. Observe associated Safety Instructions! $C_o = 150 \mu\text{F}$ $L_o = 25 \text{ mH}$		



71261755

www.addresses.endress.com
