

Installation Instructions

Kit for Oxymax COS61/COS61D

For optical sensors for measuring dissolved oxygen



Table of contents

1 Overview of Oxymax COS61/COS61D 3

2 Intended use 3

3 Authorized installation personnel 4

4 Safety instructions 4

5 Scope of delivery 5

6 Additional documentation 6

7 Replacement of spare parts 7

8 Disposal 9

1 Overview of Oxymax COS61/COS61D

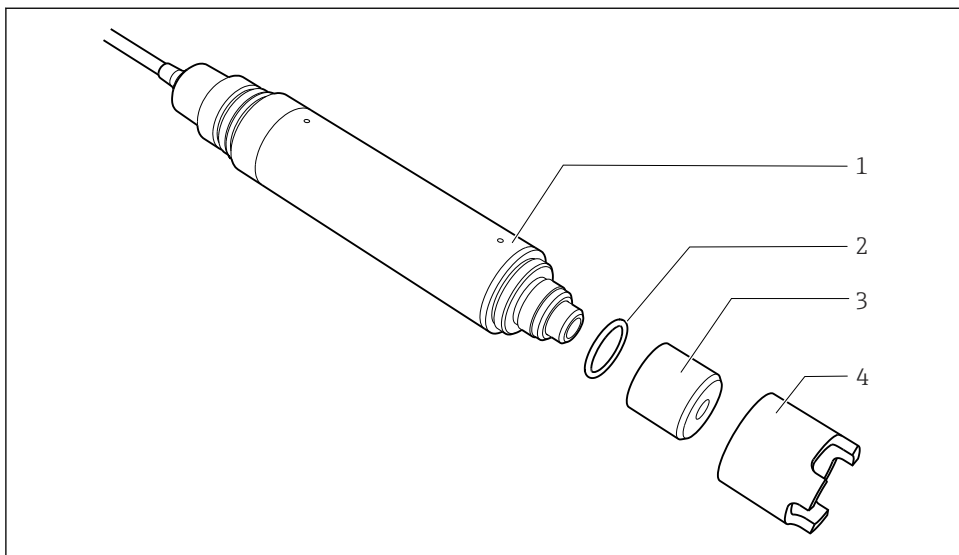

A0048705

1 Overview of Oxymax COS61/COS61D

- 1 Sensor shaft
- 2 O-ring
- 3 Optical spot cap
- 4 Protection cage

2 Intended use

- The components of the kit are to be used exclusively as retrofit or replacement parts for sensors COS61/COS61D. Any other use is not permitted!
- Use only original parts from Endress+Hauser.
- In the W@M Device Viewer, check if the spare part is suitable for the existing device.

3 Authorized installation personnel

- Installation, commissioning, operation and maintenance of the measuring system may be carried out only by specially trained technical personnel.
- The technical personnel must be authorized by the plant operator to carry out the specified activities.
- The electrical connection may be performed only by an electrical technician.
- The technical personnel must have read and understood these Installation Instructions and must follow the instructions they contain.
- Faults at the measuring point may only be rectified by authorized and specially trained personnel.

 Repairs not described in the Operating Instructions provided must only be carried out directly at the manufacturer's site or by the service organization.

4 Safety instructions

WARNING

Risk of injury from high pressure, high temperature or chemical hazards if process medium escapes!

- ▶ Before installing or removing an assembly, depressurize the system, drain the system and clean it.

CAUTION

Risk to health due to contact with the process medium

- ▶ Wear protective gloves, protective goggles and protective clothing, particularly when working with reagents, chemicals or process solutions.
- ▶ In case of contact with eyes or skin, rinse the affected area with plenty of water and then seek medical advice. Show the relevant safety data sheet to the physician.

NOTICE

Material damage due to solvents!



- ▶ Do not use any halogen-containing organic solvents or acetone. These solvents could destroy plastic components of the assembly.

 **Potential impact on the process**

Before decommissioning an active device, the potential impact on the overall process must be taken into account! This applies in particular when using the associated measuring device to control process variables.

5 Scope of delivery

5.1 Kit COV61

In terms of the quantity and version, the contents of your kit depend on the sensor version ordered (see the following order structure) →  2,  6:

COV61	For sensor	
	1	COS61
	2	COS61D
	Optical spot cap	
	A	COS61
	B	COS61D with serial number ending 000
	C	COS61D with serial number ending 001
	Number of optical spot caps	
	1	1 pieces
	3	3 pieces
	>> Maintenance parts	
	MA	Seal set



A0048706

2 Kit COV61

- 1 Seal set
- 2 Optical spot cap
- 3 Optical spot cap for COS61D with serial number ending 001 (gray)
- 4 Optical spot cap for COS61D with serial number ending 000 (black)
- 5 Optical spot cap for COS61

6 Additional documentation

Detailed information on the device can be found in the Operating Instructions for the sensor and in the other documentation available via:

- www.endress.com/device-viewer
- Smartphone / tablet: Endress+Hauser Operations App

7 Replacement of spare parts

- ▶ Replace the O-ring immediately if it is damaged.

i Recommendation: Always replace the O-ring each time you replace the sensor cap.

Replacing the O-ring

1. Clean the sensor before replacing the O-ring. A cleaning agent appropriate to the type of contamination should be used for this purpose. More information on this can be found in Operating Instructions BA00460C/07 and BA00387C/07, which can be found in the Downloads area at www.endress.com.
2. Remove the protection cage or cleaning unit.

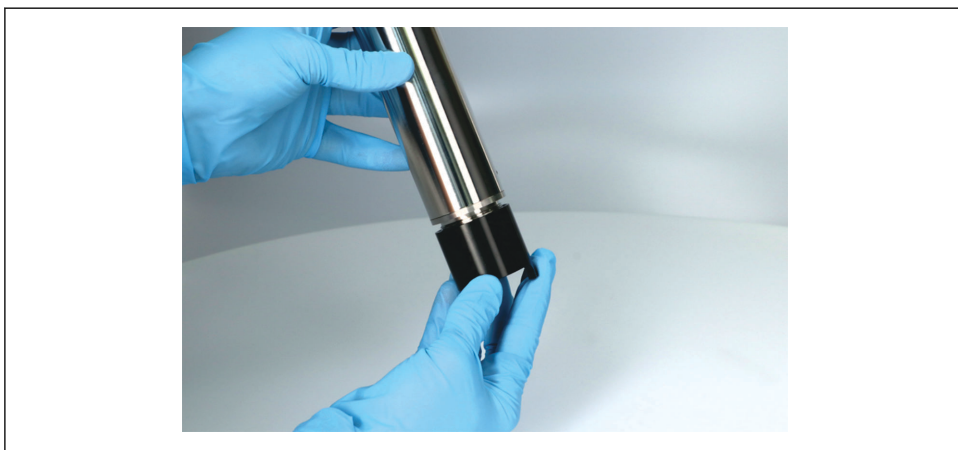

A0048707

3. Unscrew and remove the optical spot cap.

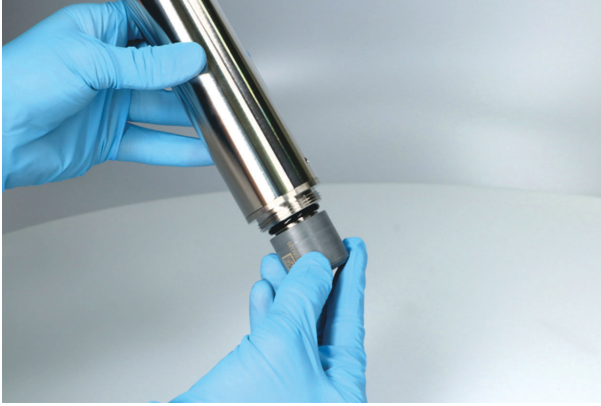

A0048708

NOTICE**Material damage caused by mechanical cleaning of optical components!**

Polishing or scratching can result in the impaired functionality or total failure of the sensor.

- ▶ Clean the optical components by dabbing them carefully with a soft cleaning cloth.
- 4. Carefully remove the existing O-ring from the sensor, e.g. with an O-ring picker. Do not use any sharp objects when installing, so as not to damage the sensor.
- 5. Carefully mount the new O-ring. When installing, make sure that the O-ring is not damaged by the thread.
- 6. Screw on the optical sensor cap.

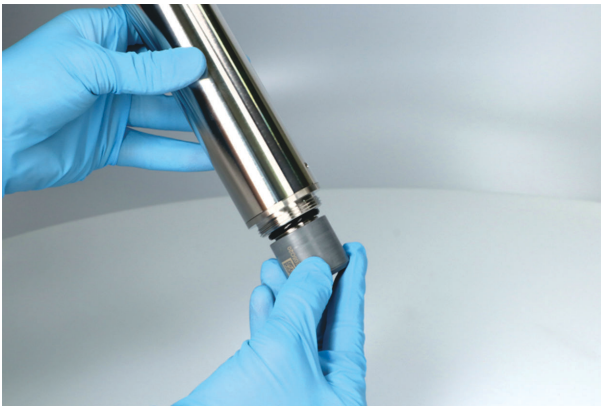

A0048708

7. Calibrate sensor.
8. Screw on the protection cage or cleaning unit.

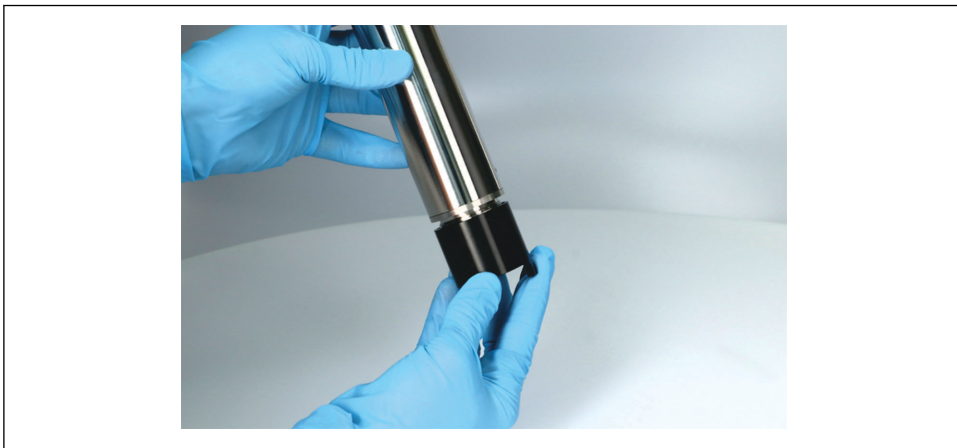

A0048707

8 Disposal

8.1 Sensors



If required by the Directive 2012/19/EU on waste electrical and electronic equipment (WEEE), the product is marked with the depicted symbol in order to minimize the disposal of WEEE as unsorted municipal waste. Do not dispose of products bearing this marking as unsorted municipal waste. Instead, return them to Endress+Hauser for disposal under the applicable conditions.



71570156

www.addresses.endress.com
