

Brief Operating Instructions

Rxn-45 Raman spectroscopic probe



Table of Contents

1	About this document.....	4
1.1	Disclaimer	4
1.2	Warnings	4
1.3	Symbols	5
1.4	U.S. export compliance.....	5
2	Basic safety instructions	6
2.1	Requirements for personnel.....	6
2.2	Designated use	6
2.3	Workplace safety.....	6
2.4	Operational safety.....	7
2.5	Laser safety.....	7
2.6	Service safety.....	8
2.7	Important safeguards.....	8
2.8	Product safety.....	8
3	Product description	10
3.1	Rxn-45 probe.....	10
4	Incoming product acceptance and product identification	11
4.1	Incoming acceptance.....	11
4.2	Product identification	11
4.3	Scope of delivery.....	12
5	Probe and fiber optic connection	13
6	Installation	14
6.1	Installation process.....	14
7	Commissioning.....	16
7.1	Receipt of probe.....	16
7.2	Probe calibration and verification.....	16
8	Operation.....	17
9	Diagnostics and troubleshooting.....	18

1 About this document

1.1 Disclaimer

These instructions are Brief Operating Instructions; they do not replace the Operating Instructions included in the scope of supply.

1.2 Warnings



Structure of Information	Meaning
<p> WARNING</p> <p>Causes (/consequences) If necessary, consequences of non-compliance (if applicable)</p> <ul style="list-style-type: none"> ▶ Corrective action 	<p>This symbol alerts you to a dangerous situation. Failure to avoid the dangerous situation can result in a fatal or serious injury.</p>
<p> CAUTION</p> <p>Causes (/consequences) If necessary, consequences of non-compliance (if applicable)</p> <ul style="list-style-type: none"> ▶ Corrective action 	<p>This symbol alerts you to a dangerous situation. Failure to avoid this situation can result in minor or more serious injuries.</p>
<p>NOTICE</p> <p>Cause/situation If necessary, consequences of non-compliance (if applicable)</p> <ul style="list-style-type: none"> ▶ Action/note 	<p>This symbol alerts you to situations which may result in damage to property.</p>

Table 1. Warnings

1.3 Symbols





Symbol	Description
	The Laser Radiation symbol is used to alert the user to the danger of exposure to hazardous visible laser radiation when using the system.
	The High Voltage symbol that alerts people to the presence of electric potential large enough to cause injury or damage. In certain industries, high voltage refers to voltage above a certain threshold. Equipment and conductors that carry high voltage warrant special safety requirements and procedures.
	The WEEE symbol indicates that the product should not be discarded as unsorted waste but must be sent to separate collection facilities for recovery and recycling.
	The CE Marking indicates conformity with health, safety, and environmental protection standards for products sold within the European Economic Area (EEA).

Table 2. Symbols

1.4 U.S. export compliance

The policy of Endress+Hauser is strict compliance with U.S. export control laws as detailed in the website of the [Bureau of Industry and Security](#) at the U.S. Department of Commerce.

2 Basic safety instructions

2.1 Requirements for personnel

- Installation, commissioning, operation, and maintenance of the measuring system may be carried out only by specially trained technical personnel.
- The technical personnel must be authorized by the plant operator to carry out the specified activities.
- The technical personnel must have read and understood these Operating Instructions and must follow the instructions contained herein.
- The facility must designate a laser safety officer who ensures staff are trained on all Class 3B laser operating and safety procedures.
- Faults at the measuring point may only be rectified by properly authorized and trained personnel. Repairs not described in this document must be carried out only directly at the manufacturer's site or by the service organization.

2.2 Designated use

The Rxn-45 Raman spectroscopic probe is designed for the needs of bioprocessing pilot and manufacturing sites.

Recommended applications include:

- **Cell culture:** Glucose, lactate, amino acids, cell density, titer, and more
- **Fermentation:** Glucose, glycerol, acetate, methanol, ethanol, biomass, and more

Use of the device for any purpose other than that described, poses a threat to the safety of people and of the entire measuring system and invalidates any warranty.

2.3 Workplace safety

As the user, you are responsible for complying with the following safety conditions:

- Installation guidelines
- Local standards and regulations for electromagnetic compatibility

The product has been tested for electromagnetic compatibility in accordance with the applicable international standards for industrial applications.

The electromagnetic compatibility indicated applies only to a product that has been properly connected to the analyzer.

2.4 Operational safety

Before commissioning the entire measuring point:

1. Verify that all connections are correct.
2. Ensure that electro-optical cables are undamaged.
3. Ensure fluid level is sufficient for probe/optics immersion (if applicable).
4. Do not operate damaged products, and protect them against unintentional operation.
5. Label damaged products as defective.

During operation:

1. If faults cannot be rectified, products must be taken out of service and protected against unintentional operation.
2. When working with laser devices, always follow all local laser safety protocols which may include the use of personal protective equipment and limiting device access to authorized users.

2.5 Laser safety

The Raman Rxn analyzers use Class 3B lasers as defined in the following:

- [American National Standards Institute](#) (ANSI) Z136.1, American National Standard for Safe Use of Lasers
- [International Electrotechnical Commission](#) (IEC) 60825-1, Safety of Laser Products – Part 1

WARNING

Direct eye contact with the output beam from the laser will cause severe damage and possible blindness.

CAUTION

Laser beams can cause ignition of certain substances such as volatile organic compounds.

The two possible mechanisms for ignition are direct heating of the sample to a point causing ignition and the heating of a contaminant (such as dusts) to a critical point leading to ignition of the sample.

The laser configuration presents further safety concerns because the radiation is nearly invisible. Always be aware of the initial direction and possible scattering paths of the laser. The use of laser safety glasses with OD3 (or greater) is highly recommended for 532 nm and 785 nm excitation wavelengths and OD4 (or greater) for a 993 nm excitation wavelength.

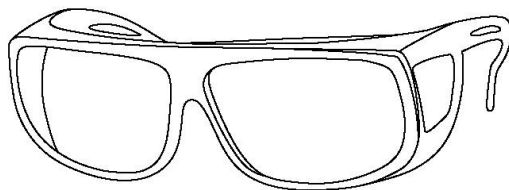

Figure 1. Laser safety glasses

For more assistance with taking appropriate precautions and setting the proper controls when dealing with lasers and their hazards, refer to the most current version of ANSI Z136.1 or IEC 60825-14.

2.6 Service safety

Follow your company's safety instructions when removing a process probe from the process interface for service. Always wear proper protective equipment when servicing the equipment.

2.7 Important safeguards

- Do not use the Rxn-45 probe for anything other than its intended use.
- Do not look directly into the laser beam.
- Do not point laser at a mirrored/shiny surface or a diffuse surface. The reflections from these may be harmful.
- Do not leave attached and unused probes uncapped or unblocked.
- Always use a laser beam block to avoid inadvertent scatter of laser radiation.

2.8 Product safety

This product is designed to meet all current safety requirements, has been tested, and shipped from the factory in a safe operating condition. The relevant regulations and international standards have been observed. Devices connected to an analyzer must also comply with the applicable analyzer safety standards.

Endress+Hauser Raman spectroscopy systems incorporate the following safety features to conform to the United States Government requirements 21 [Code of Federal Regulations](#) (CFR) Chapter 1, Subchapter J as administered by the [Center for Devices and Radiological Health](#) (CDRH) and IEC-60825-1 as administered by the [International Electrotechnical Commission](#).

2.8.1 CDRH and IEC compliance

Endress+Hauser Raman analyzers are certified by Endress+Hauser to meet CDRH requirements, as well as IEC-60825-1 safety standards for international use.

Endress+Hauser Raman analyzers have been registered with the CDRH. Any unauthorized modifications to an existing Raman Rxn analyzer or accessory may result in hazardous radiation exposure. Such modifications may result in the system being no longer in conformance with Federal requirements as certified by Endress+Hauser.

2.8.2 Laser safety interlock

The Rxn-45 probe, as installed, forms part of the interlock circuit. The interlock circuit is a low-current electrical loop. If the fiber cable is severed, the laser will turn off within 20 milliseconds of the breakage.

NOTICE

Handle probes and cables with care.

Fiber cables should NOT be kinked and should be routed to maintain the minimum bend radius of 6 inches (152.4 mm).

- ▶ Permanent damage may result if cables are not routed appropriately.

The Electro-Optical (EO) fiber cable with its embedded interlock loop must be plugged into the back of the Raman Rxn analyzer for the appropriate channel. The interlock loop is complete when the probe side of the EO fiber cable is plugged into the Rxn-45 probe.

When there is potential for the laser to be energized, the laser interlock indicator light on the probe body is illuminated.

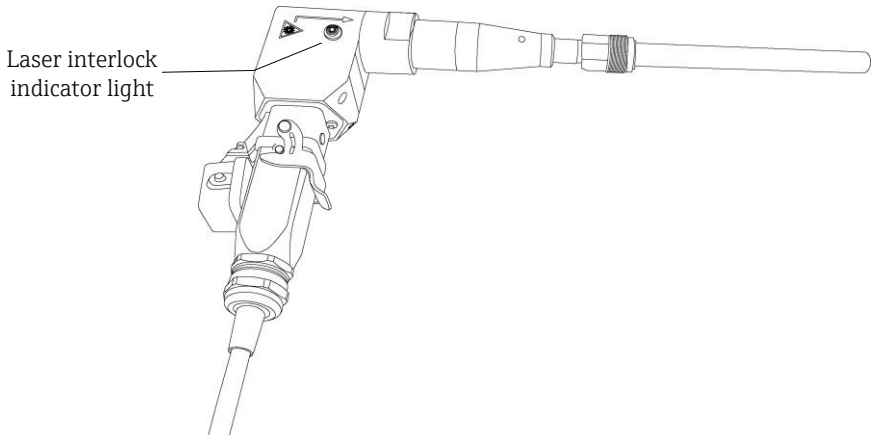

Figure 2. Location of laser interlock indicator light

3 Product description

3.1 Rxn-45 probe

The Rxn-45 Raman spectroscopic probe is a Clean-In-Place (CIP)/Steam-In-Place (SIP) compatible probe designed for *in situ* monitoring and control of bioprocess applications in development and manufacturing settings. This probe is ideally suited for side-port entry into a bioreactor or fermentor, and is compatible with Endress+Hauser Raman Rxn analyzers operating at 785 nm and 993 nm.

The Rxn-45 probe has a 120 mm immersion length with a 12 mm outer diameter and a surface finish of RA 15 or better. The PG13.5 thread connector allows for installation with multiple port types, using industry standard sensor housings for 25 mm side ports. Welded port connectors and flanges are also available in multiple brands and sizes.

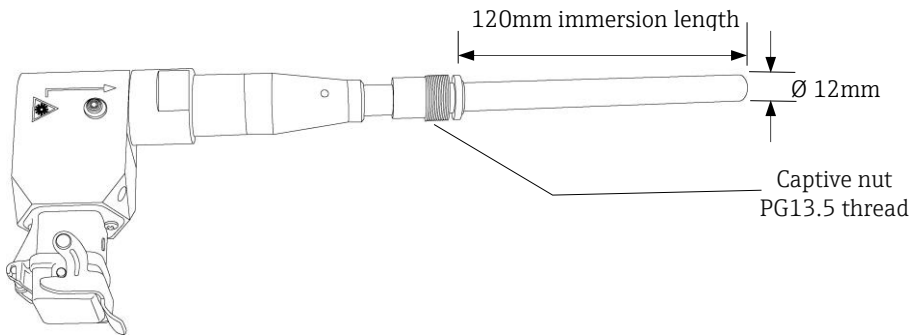

Figure 3. Rxn-45 probe

4 Incoming product acceptance and product identification

4.1 Incoming acceptance

1. Verify that the packaging is undamaged. Notify the supplier of any damage to the packaging. Keep the damaged packaging until the issue has been resolved.
2. Verify that the contents are undamaged. Notify the supplier of any damage to the delivery contents. Keep the damaged goods until the issue has been resolved.
3. Check that the delivery is complete and nothing is missing. Compare the shipping documents with your order.
4. Pack the product for storage and transportation in such a way that it is protected against impact and moisture. The original packaging offers the best protection. Make sure to comply with the permitted ambient conditions. If you have any questions, please contact your supplier or your local sales center.

NOTICE

Probe may be damaged during transport if packaged inadequately.

4.2 Product identification

4.2.1 Label

At a minimum, the probe/tag is labeled with the following information:

- Manufacturer Information
- Laser Radiation Notice
- Serial Number
- Patent Information
- Certification Information, as applicable

Compare the information on the label/tag with the order.

4.2.2 Manufacturer address

Endress+Hauser
371 Parkland Plaza
Ann Arbor, MI 48103 USA

4.3 Scope of delivery

The scope of delivery comprises:

- Rxn-45 probe
- Rxn-45 Raman spectroscopic probe Operating Instructions manual
- Certificate of Product Performance
- Local declarations of conformity, if applicable
- Rxn-45 probe optional accessories, if applicable
- Material certificates, if applicable

If you have any queries: Please contact your supplier or local sales center.

5 Probe and fiber optic connection

The Rxn-45 probe is compatible with Endress+Hauser Raman Rxn analyzers operating at 785 nm and 993 nm. The probe connects to the Raman Rxn analyzer via a user-removable Electro-Optical (EO) fiber cable. The EO fiber cable connects the Rxn-45 probe to the analyzer with a single, robust connector that contains the excitation and collection fiber-optics as well as an electrical laser interlock.

Refer to the applicable Raman Rxn analyzer operating instructions for analyzer connection details.

NOTICE

Connection of the probe to the fiber optic cable must be conducted by a qualified Endress+Hauser engineer or specially trained technical personnel.

- ▶ Unless trained by qualified personnel, customer attempts to connect the probe to the fiber optic cable can result in damage and may void the warranty.
- ▶ Contact your local Endress+Hauser service representative for additional support regarding the probe and fiber cable connection.

Standard cable length is five (5) meters. Custom lengths are available in ten (10) meter increments, starting at ten (10) meters.

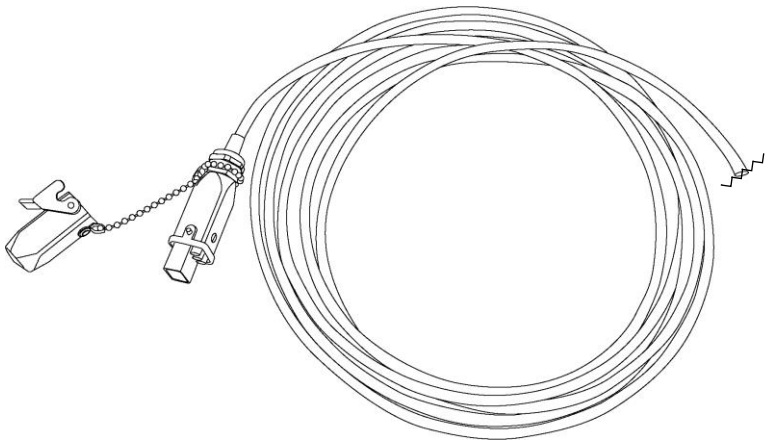

Figure 4. EO fiber cable showing connector for analyzer

6 Installation

During installation, standard eye and skin safety precautions for Class 3B laser products (as per EN-60825/IEC 60825-14) should be observed as described below.

<p>⚠ WARNING</p>	<p>Standard precautions for laser products should be observed.</p> <ul style="list-style-type: none"> ▶ Probes should always be capped and/or pointed away from people toward a diffuse target if not installed in a sample chamber.
<p>⚠ CAUTION</p>	<p>If stray light is allowed to enter an unused probe, it will interfere with data collected from a used probe and may cause calibration failure or measurement errors.</p> <ul style="list-style-type: none"> ▶ Unused probes should ALWAYS be capped to prevent stray light from entering the probe.
<p>NOTICE</p>	<p>When installing the probe <i>in situ</i>, the user must provide the strain relief to the fiber optic cable at the probe installation location.</p>

6.1 Installation process

NOTICE

When installing the probe *in situ*, the user must provide the strain relief to the fiber optic cable at the probe installation location.

To install a Rxn-45 probe, follow the steps below. Refer to the figure below to disconnect and re-connect the fiber-optic cable from the probe.

1. If the Rxn-45 probe is currently attached to a Raman Rxn analyzer, use the laser key on the front of the base unit to turn the laser OFF or power down the analyzer prior to probe installation.
2. Disconnect the fiber-optic cable from the Rxn-45 probe.
 - Unlatch the connector clip. **(A)**
 - Grasp the gray part of the EO connector and, with your other hand, pull straight down to disconnect the fiber-optic cable. **(B)**
3. Screw the appropriate adapter onto the Rxn-45 probe and secure in place using the PG13.5 thread process connector.
4. Insert the Rxn-45 probe into a side-port on the vessel.
5. Screw the adapter that is now attached to the Rxn-45 probe into a side-port on the vessel such that the fiber connector interface remains facing downward.

6. Re-connect the fiber-optic cable to the Rxn-45 probe.
 - Open the spring-loaded fiber connector cap at the base of the Rxn-45 probe. **(C)**
 - Insert the fiber cable EO connector into the base of the probe and push up until secure.
 - Re-latch the connector clip.
 7. When ready to use the analyzer and probe, power ON the laser and/or analyzer.
 8. After a minute, verify that the laser interlock indicator on the probe is illuminated.
- The Rxn-45 probe is now ready for CIP/SIP using standard bio-process water or steam cleaning processes prior to vessel filling.

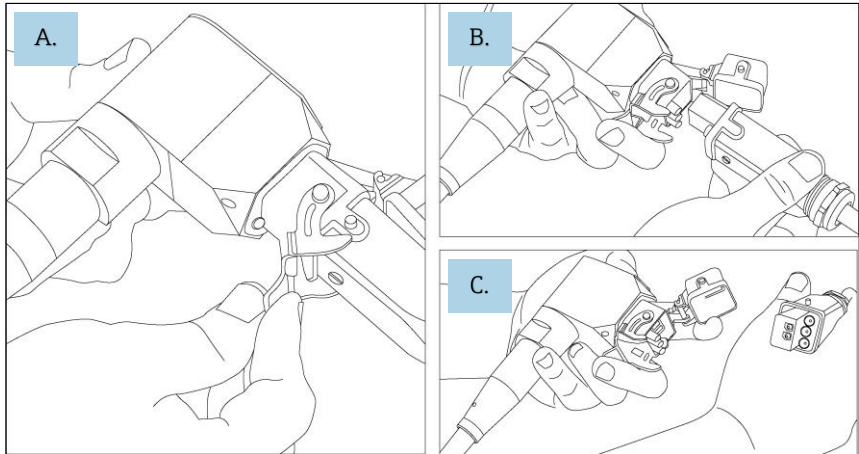

Figure 5. Disconnecting and re-connecting the fiber-optic cable

7 Commissioning

The Rxn-45 probe is delivered ready to connect to the Raman Rxn analyzer. No additional alignment or adjustment to the probe is required. Follow the instructions below to commission the probe for use.

7.1 Receipt of probe

Perform the steps for incoming product acceptance described in [Section 4.1](#).

7.2 Probe calibration and verification

The probe and the analyzer must be calibrated before use. Use the Raman Calibration Accessory (HCA) to perform an intensity calibration for the probe.

Refer to the applicable Raman Rxn analyzer operating instructions for steps to:

- Perform internal analyzer calibration; may include alignment calibration, full wavelength calibration and/or full laser wavelength calibration depending on status of analyzer
- Perform probe calibration; requires HCA
- Perform probe verification; verifies the calibration results using a standard reference sample
- View calibration and verification reports

The Raman RunTime software will not allow spectra to be collected without passing internal analyzer and probe calibrations. Passing the probe verification step is not required but highly recommended.

Raman Rxn analyzer operating instructions are available by searching the Downloads area of the Endress+Hauser web site: www.endress.com → Downloads

8 Operation

The Endress+Hauser Rxn-45 probe is a compact probe designed for the needs of bioprocessing pilot and manufacturing sites. The probe is compatible with Endress+Hauser Raman Rxn analyzers operating at 785 nm and 993 nm.

CAUTION

Do NOT use the Rxn-45 probe with hydrocarbon solvents, including ketones and aromatics.

These solvents can damage the window material, degrade probe performance and invalidate the warranty.

Refer to the applicable Raman Rxn analyzer operating instructions for additional instructions for use.

9 Diagnostics and troubleshooting

Refer to the table below when troubleshooting issues with the Rxn-45 probe. If the probe is damaged, isolate the probe from the process and turn off the laser prior to evaluation. Contact your service representative as needed for assistance.

Symptom		Possible cause	Action
1	Substantial reduction in signal or signal-to-noise ratio	Window fouling	<ol style="list-style-type: none"> Carefully remove probe from the process, decontaminate, and inspect optical window at tip of probe. If necessary, clean the window before returning it to service.
		Cracked but intact fiber	Verify condition of fiber and contact your service representative for replacement.
2	Complete loss of signal while laser is powered and laser interlock indicator is lit	Broken fiber without interlock wire breakage	Ensure all fiber connections are secure. Verify condition of fiber and contact your service representative for replacement.
3	Laser interlock indicator on probe is not lit	Damaged fiber assembly	Look for signs of breakage in fiber. Contact your service representative for replacement.
		Fiber cable EO connector not secured/latched	Ensure EO connector is properly connected and latched at the probe (if applicable) and at the analyzer.
		Remote interlock connector disconnected	Ensure the twist-lock remote interlock connector at the rear of analyzer (next to fiber EO connector) is connected.
4	Unstable signal and contamination visible behind window	Window seal failure	<ol style="list-style-type: none"> Examine the area inside the window for moisture or condensation. Examine the probe for fluid penetration or signs of sample fluid in the probe body (e.g., corrosion, residue). Look for any sign of spectral deviation. If any of the above are noted, contact your service representative to return the probe to the manufacturer.
5	Decreased laser power or collection efficiency	Contaminated fiber connection	Carefully clean the fiber ends at the probe. Refer to the applicable Raman Rxn analyzer operating instructions for cleaning instructions and steps for starting up a new probe.

Symptom		Possible cause	Action
6	Laser interlock on analyzer causes laser to shut down	Laser interlock activated	Check for fiber breakage on all connected fiber optic cable channels and ensure remote interlock connectors are in place on each channel.
7	Unrecognized bands or patterns in the spectra	Cracked but intact fiber	Verify possible causes and contact your service representative to return the damaged product.
		Contaminated probe tip	
8	Other unexplained negative performance of the probe	Physical damage to probe	Contact your service representative to return the damaged product.

Table 3. Troubleshooting

www.addresses.endress.com
