

Brief Operating Instructions

Memosens COS51E

Amperometric oxygen sensor with Memosens 2.0 technology



These instructions are Brief Operating Instructions; they are not a substitute for the Operating Instructions pertaining to the device.

Detailed information on the device can be found in the Operating Instructions and in the other documentation available at:

- www.endress.com/device-viewer
- Smart phone/tablet: Endress+Hauser Operations App

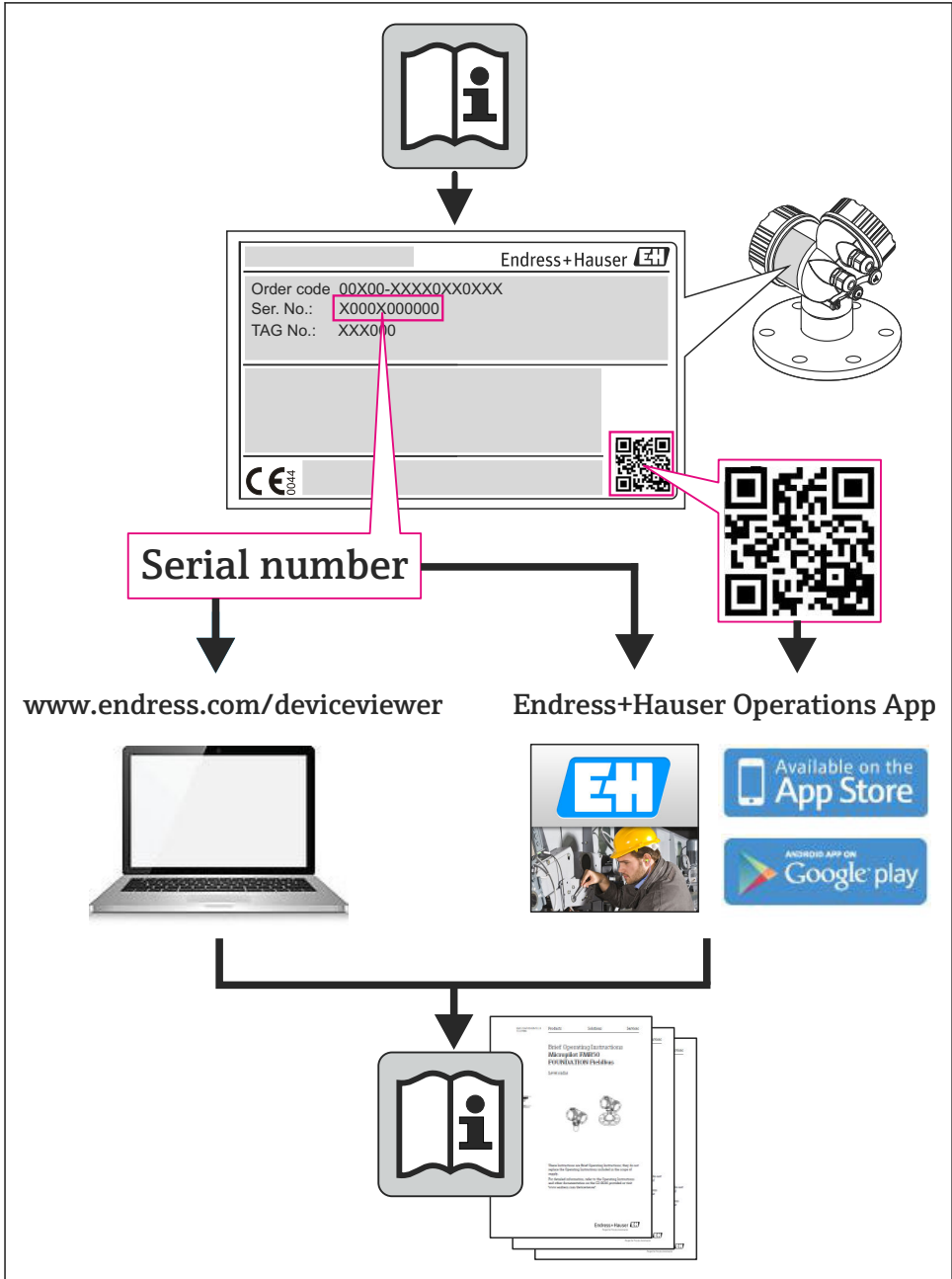



A0023555

Table of contents

- 1 Document information 3**
 - 1.1 Safety information 3
 - 1.2 Symbols used 4
 - 1.3 Documentation 4
- 2 Basic safety instructions 5**
 - 2.1 Requirements for personnel 5
 - 2.2 Intended use 5
 - 2.3 Occupational safety 5
 - 2.4 Operational safety 5
 - 2.5 Product safety 6
- 3 Installation 7**
 - 3.1 Installation conditions 7
 - 3.2 Mounting the sensor 9
 - 3.3 Post-installation check 10
- 4 Electrical connection 10**
 - 4.1 Connecting the sensor 10
 - 4.2 Ensuring the degree of protection 11
 - 4.3 Post-connection check 11
- 5 Commissioning 11**
 - 5.1 Function check 11







1 Document information

1.1 Safety information



Structure of information	Meaning
<p> DANGER</p> <p>Causes (/consequences) If necessary, Consequences of non-compliance (if applicable) ► Corrective action</p>	<p>This symbol alerts you to a dangerous situation. Failure to avoid the dangerous situation will result in a fatal or serious injury.</p>
<p> WARNING</p> <p>Causes (/consequences) If necessary, Consequences of non-compliance (if applicable) ► Corrective action</p>	<p>This symbol alerts you to a dangerous situation. Failure to avoid the dangerous situation can result in a fatal or serious injury.</p>

Structure of information	Meaning
<p>⚠ CAUTION</p> <p>Causes (/consequences) If necessary, Consequences of non-compliance (if applicable) ▶ Corrective action</p>	<p>This symbol alerts you to a dangerous situation. Failure to avoid this situation can result in minor or more serious injuries.</p>
<p>NOTICE</p> <p>Cause/situation If necessary, Consequences of non-compliance (if applicable) ▶ Action/note</p>	<p>This symbol alerts you to situations which may result in damage to property.</p>

1.2 Symbols used

-  Additional information, tips
-  Permitted or recommended
-  Not permitted or not recommended
-  Reference to device documentation
-  Reference to page
-  Reference to graphic
-  Result of a step

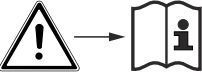
1.2.1 Symbols on the device

Symbol	Meaning
	<p>Reference to device documentation</p>
	<p>Do not dispose of products bearing this marking as unsorted municipal waste. Instead, return them to the manufacturer for disposal under the applicable conditions.</p>

1.3 Documentation

The following manuals which complement these Operating Instructions can be found on the product pages on the Internet:

- Operating Instructions for the relevant sensor
- Technical Information for the relevant sensor
- Operating Instructions for the transmitter used
- Operating Instructions for the cable used
- Safety data sheet for the relevant electrolyte solutions

In addition to these Operating Instructions, an XA with "Safety instructions for electrical apparatus in the hazardous area" is also included with sensors for use in the hazardous area.

- ▶ Please follow instructions on use in the hazardous area carefully.

2 Basic safety instructions

2.1 Requirements for personnel

- Installation, commissioning, operation and maintenance of the measuring system may be carried out only by specially trained technical personnel.
- The technical personnel must be authorized by the plant operator to carry out the specified activities.
- The electrical connection may be performed only by an electrical technician.
- The technical personnel must have read and understood these Operating Instructions and must follow the instructions contained therein.
- Faults at the measuring point may only be rectified by authorized and specially trained personnel.



Repairs not described in the Operating Instructions provided must be carried out only directly at the manufacturer's site or by the service organization.

2.2 Intended use

Use of the device for any purpose other than that described, poses a threat to the safety of people and of the entire measuring system and is therefore not permitted.

The manufacturer is not liable for damage caused by improper or non-designated use.

The sensor is suitable for continuous measurement of dissolved oxygen in aqueous solutions.

The sensor is particularly suitable for:

- Measuring, monitoring and regulating the oxygen content in activated sludge basins
- Monitoring the oxygen content in the wastewater treatment plant outlet
- Monitoring, measuring and regulating the oxygen content in public waters and fish farming water

2.3 Occupational safety

As the user, you are responsible for complying with the following safety conditions:

- Installation guidelines
- Local standards and regulations
- Regulations for explosion protection

Electromagnetic compatibility

- The product has been tested for electromagnetic compatibility in accordance with the applicable international standards for industrial applications.
- The electromagnetic compatibility indicated applies only to a product that has been connected in accordance with these Operating Instructions.

2.4 Operational safety

Before commissioning the entire measuring point:

1. Verify that all connections are correct.
2. Ensure that electrical cables and hose connections are undamaged.

3. Do not operate damaged products, and protect them against unintentional operation.
4. Label damaged products as defective.

During operation:

- ▶ If faults cannot be rectified:
products must be taken out of service and protected against unintentional operation.

⚠ CAUTION**Cleaning not switched off during calibration or maintenance activities**

Risk of injury due to medium or cleaning agent!

- ▶ If a cleaning system is connected, switch it off before removing a sensor from the medium.
- ▶ If you need to test the cleaning function while cleaning is in progress, wear protective clothing, goggles and gloves or take other suitable measures to protect yourself.

2.5 Product safety

2.5.1 State-of-the-art technology

The product is designed to meet state-of-the-art safety requirements, has been tested, and left the factory in a condition in which it is safe to operate. The relevant regulations and international standards have been observed.

3 Installation

3.1 Installation conditions

3.1.1 Dimensions

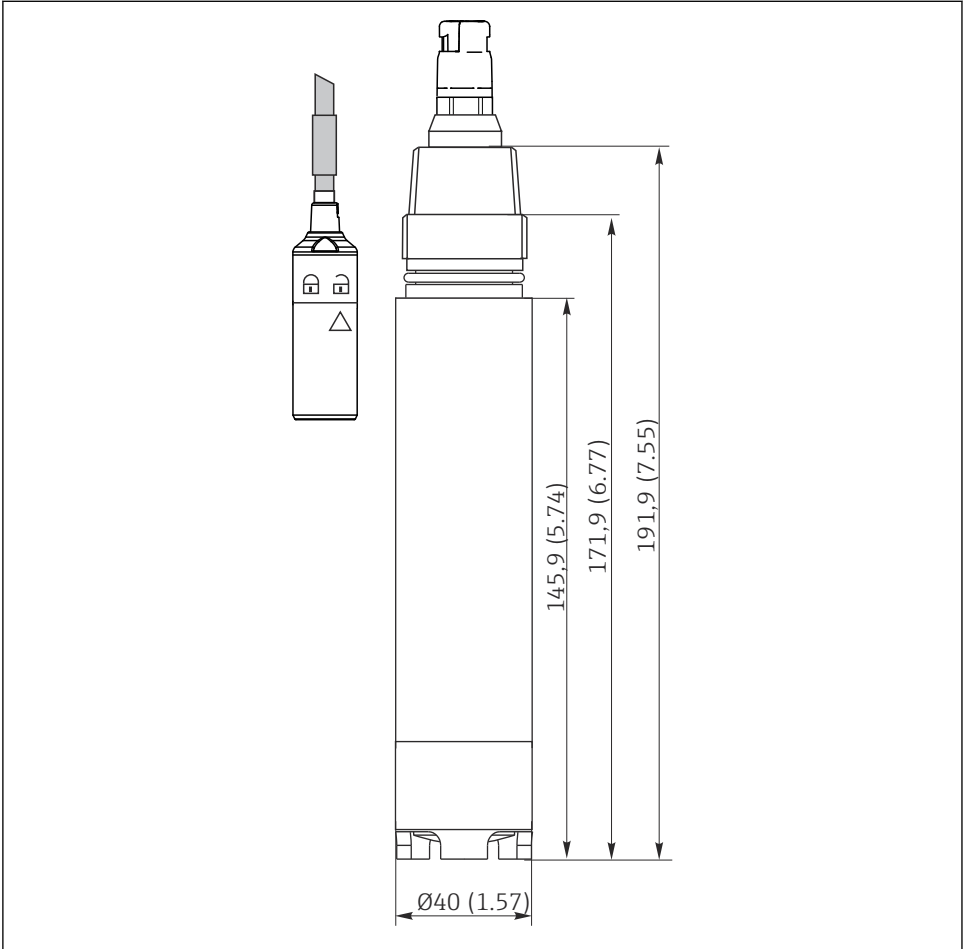



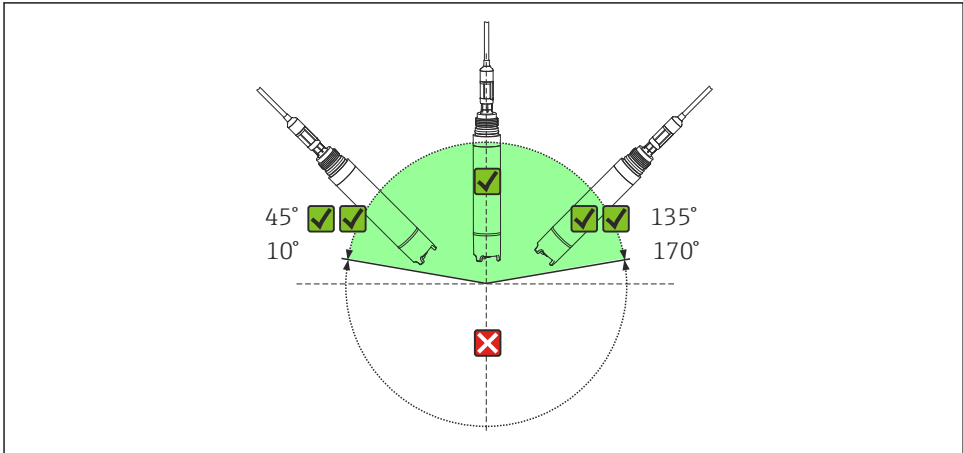

A0045976

1 Dimensions in mm (inch)

3.1.2 Orientation



A0030544

-  2 Permitted orientations
-  Recommended installation angle
-  Possible installation angle
-  Inadmissible installation angle

The sensor must be installed at an angle of inclination of 10° to 170° in an assembly, holder or suitable process connection. Recommended angle: 45° to prevent the attachment of air bubbles.

Inclination angles other than those mentioned are not permitted. Do **not** install the sensor upside down.

-  Follow the instructions for installing sensors in the Operating Instructions for the assembly used.

3.1.3 Mounting location

1. Choose a mounting location that is easy to access.
2. Ensure that upright posts and assemblies are fully secured and vibration-free.
3. Choose a mounting location with an oxygen concentration that is typical for the application.

3.2 Mounting the sensor

3.2.1 Measuring system

A complete measuring system comprises:

- a Memosens COS51E oxygen sensor
- a transmitter e.g. CM44x
- a measuring cable, e.g. CYK10
- optional: an assembly, e.g. immersion assembly CYA112 or retractable assembly COA451
- optional: a CYH112 assembly holder
- optional: a cleaning unit with compressed air system
- optional: other protection guards (71096199)

3.2.2 Installing at a measuring point



Install assemblies away from the basin on a solid base. Only the final stage of assembly should be performed at the intended mounting location. Choose a mounting location that ensures correct handling of the assembly (installation, operation, maintenance).

Must be installed in a suitable assembly (depending on the application).



Electrical voltage

In the event of a fault, non-grounded metallic assemblies may be live and as such are not safe to touch!

- ▶ When using metallic assemblies and installation equipment, national grounding provisions must be observed.

To fully install a measuring point with a flow assembly or retractable assembly, proceed in accordance with the following steps:

1. Install the retractable or flow assembly (if used) in the process.
2. Install the oxygen sensor in the assembly
3. Connect the cable to the sensor and transmitter
4. Connect the water supply to the rinsing nozzles provided (if using an assembly with cleaning function).
5. Supply power to the transmitter

To fully install a measuring point with a suspended or immersion assembly, proceed in accordance with the following steps:

1. Install the oxygen sensor in the assembly
2. Connect the cable to the sensor and transmitter
3. Install the suspended or immersion assembly in the process
4. Supply power to the transmitter

NOTICE**Installation fault**

Cable open circuit, loss of sensor due to cable separation, unscrewing of membrane cap in the assembly!

- ▶ For immersion operation, the sensor must be installed in an immersion assembly (such as CYA112). Do not install the sensor freely suspended from the cable!
- ▶ Avoid exerting excessive tensile force on the cable (e.g. through jerky pulling movements).
- ▶ Choose a mounting location that is easy to access for later calibrations.
- ▶ Follow the instructions for installing sensors in the Operating Instructions for the assembly used.

3.3 Post-installation check

1. Are the sensor and cable undamaged?
2. Is the orientation correct?
3. Is the sensor installed in an assembly and is not suspended from the cable?
4. Avoid the penetration of moisture.

4 Electrical connection**⚠ WARNING****Device is live!**

Incorrect connection may result in injury or death!

- ▶ The electrical connection may be performed only by an electrical technician.
- ▶ The electrical technician must have read and understood these Operating Instructions and must follow the instructions contained therein.
- ▶ **Prior** to commencing connection work, ensure that no voltage is present on any cable.

4.1 Connecting the sensor

The electrical connection of the sensor to the transmitter is established using the measuring cable CYK10.

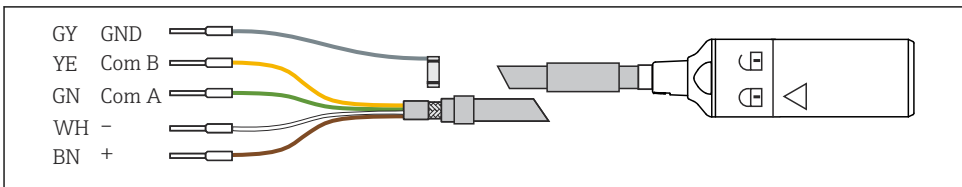

A0024019

3 Measuring cable CYK10

4.2 Ensuring the degree of protection

Only the mechanical and electrical connections which are described in these instructions and which are necessary for the required, designated use, may be carried out on the device delivered.

- ▶ Exercise care when carrying out the work.

Otherwise, the individual types of protection (Ingress Protection (IP), electrical safety, EMC interference immunity) agreed for this product can no longer be guaranteed due, for example to covers being left off or cable (ends) that are loose or insufficiently secured.

4.3 Post-connection check

Device health and specifications	Action
Is the outside of the sensor, assembly or cable free from damage?	▶ Perform a visual inspection.
Electrical connection	Action
Are the mounted cables strain-relieved and not twisted?	▶ Perform a visual inspection. ▶ Untwist the cables.
Is a sufficient length of the cable cores stripped, and are the cores positioned in the terminal correctly?	▶ Perform a visual inspection. ▶ Pull gently to check they are seated correctly.
Are all screw terminals tightened?	▶ Tighten the screw terminals.
Are all cable entries mounted, firmly tightened and leak-tight?	▶ Perform a visual inspection. In the case of lateral cable entries:
Are all cable entries mounted on the side or pointing downwards?	▶ Point cable loops downward so that water can drip off.

5 Commissioning

5.1 Function check

Prior to initial commissioning, ensure that:

- Is the sensor correctly installed?
- Is the electrical connection correct?

If using an assembly with automatic cleaning function:

- ▶ Check that the cleaning medium (water or air, for example) is connected correctly.

⚠ WARNING**Escaping process medium**

Risk of injury from high pressure, high temperatures or chemical hazards!

- ▶ Before applying pressure to an assembly with cleaning system, ensure that the system has been connected correctly.
- ▶ If you cannot reliably establish the correct connection, do not install the assembly in the process.

1. At the transmitter, enter all the settings specific to the parameters and measuring point. These include the air pressure during calibration and measurement or the salinity, for instance.
2. Check whether a calibration/adjustment is necessary.

The oxygen measuring point is then ready to measure.

 After commissioning, maintain the sensor at regular intervals to ensure reliable measurement. Further information on this can be found in the Operating Instructions for the sensor.

-  ■ Operating Instructions for Memosens COS51E, BA02146C
■ Operating Instructions for the transmitter used, such as BA01245C if using the Liquiline CM44x or Liquiline CM44xR.



71537424

www.addresses.endress.com
