

Safety Instructions

Soliphant M

FTM50, FTM51, FTM52

ATEX: II 1 G Ex ia IIC T6 Ga
II 1/2 G Ex ia IIC T6 Ga/Gb
II 1 D Ex ia IIIC Txx°C Da
II 1/2 D Ex ia IIIC Txx°C Da/Db
IECEX: Ex ia IIC T6 Ga, Ga/Gb
Ex ia IIIC Txx°C Da, Da/Db



Soliphant M FTM50, FTM51, FTM52

Table of contents

About this document	4
Associated documentation	4
Supplementary documentation	4
General notes: Combined approval	4
Manufacturer's certificates	5
Manufacturer address	5
Other standards	6
Extended order code	6
Safety instructions: General	8
Safety instructions: Special conditions	9
Safety instructions: Installation	10
Safety instructions: Zone 0	15
Safety instructions: Zone 0, Zone 20	15
Temperature tables	16
Connection data	19

About this document

 This document has been translated into several languages. Legally determined is solely the English source text.

The document translated into EU languages is available:

- In the download area of the Endress+Hauser website:
www.endress.com -> Downloads -> Manuals and Datasheets -> Type: Ex Safety Instruction (XA) -> Text Search: ...
- In the Device Viewer: www.endress.com -> Product tools -> Access device specific information -> Check device features

 If not yet available, the document can be ordered.

Associated documentation

This document is an integral part of the following Operating Instructions:

- KA00229F/00 (FTM50, FTM51)
- KA00230F/00 (FTM52)

Supplementary documentation

Explosion-protection brochure: CP00021Z/11

The Explosion-protection brochure is available:

- In the download area of the Endress+Hauser website:
www.endress.com -> Downloads -> Brochures and Catalogs -> Text Search: CP00021Z
- On the CD for devices with CD-based documentation

**General notes:
Combined approval**

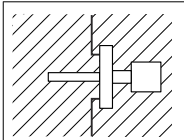
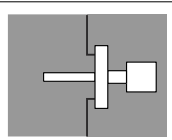
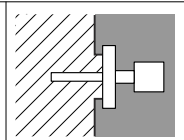
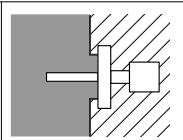
							
Ex ia IIC		Ex ia IIC		Ex ia IIC	Ex ia IIC	Ex ia IIC	Ex ia IIC
Zone 0	Zone 1	Zone 20	Zone 21	Zone 0	Zone 21	Zone 20	Zone 1
or		or		or		or	
Zone 1		Zone 21		Zone 1		Zone 21	

The device is designed for operation in explosive gas or explosive dust atmosphere as shown in the sketch above. In the event of potentially

explosive gas-air and dust-air mixtures occurring simultaneously:
Suitability requires further assessment.



A sequential change between gas and dust explosion protection is only possible if:

- A period with non-explosive atmosphere is realized during the transition or
- Special examinations are done which are not covered by the certificate

Manufacturer's certificates

EU Declaration of Conformity

Declaration Number:
EG05023

The EU Declaration of Conformity is available:
In the download area of the Endress+Hauser website:
www.endress.com -> Downloads -> Declaration ->
Type: EU Declaration -> Product Code: ...

EU type-examination certificate

Certificate number:
KEMA 05 ATEX 1019X

List of applied standards: See EU Declaration of Conformity.

IEC Declaration of Conformity

Certificate number:
IECEX DEK 15.0042 X

Affixing the certificate number certifies conformity with the following standards (depending on the device version):

- IEC 60079-0 : 2017
- IEC 60079-11 : 2011
- IEC 60079-26 : 2014

Manufacturer address

Endress+Hauser SE+Co. KG
Hauptstraße 1
79689 Maulburg, Germany

Address of the manufacturing plant: See nameplate.

- Other standards** Among other things, the following standards shall be observed in their current version for proper installation:
- IEC/EN 60079-14: "Explosive atmospheres - Part 14: Electrical installations design, selection and erection"
 - EN 1127-1: "Explosive atmospheres - Explosion prevention and protection - Part 1: Basic concepts and methodology"

Extended order code The extended order code is indicated on the nameplate, which is affixed to the device in such a way that it is clearly visible. Additional information about the nameplate is provided in the associated Operating Instructions.

Structure of the extended order code

FTM5x	–	*****	+	A*B*C*D*E*F*G*..
<i>(Device type)</i>		<i>(Basic specifications)</i>		<i>(Optional specifications)</i>

* = Placeholder

At this position, an option (number or letter) selected from the specification is displayed instead of the placeholders.

Basic specifications

The features that are absolutely essential for the device (mandatory features) are specified in the basic specifications. The number of positions depends on the number of features available.

The selected option of a feature can consist of several positions.

Optional specifications

The optional specifications describe additional features for the device (optional features). The number of positions depends on the number of features available. The features have a 2-digit structure to aid identification (e.g. JA). The first digit (ID) stands for the feature group and consists of a number or a letter (e.g. J = Test, Certificate). The second digit constitutes the value that stands for the feature within the group (e.g. A = 3.1 material (wetted parts), inspection certificate).

More detailed information about the device is provided in the following tables. These tables describe the individual positions and IDs in the extended order code which are relevant to hazardous locations.

Extended order code: Soliphant M



The following specifications reproduce an extract from the product structure and are used to assign:

- This documentation to the device (using the extended order code on the nameplate).
- The device options cited in the document.

Device type

FTM50, FTM51, FTM52

Basic specifications

Position 1 (Approval)		
Selected option		Description
FTM5x	1	ATEX II 1 D, 1/2 D Ex ia IIIC Txx°C, II 1 G, 1/2 G Ex ia IIC T6 ¹⁾
	E	IECEx Ex ia IIIC Txx°C, Ex ia IIC T6 ¹⁾

1) For detailed information see "Safety instructions: Installation" chapter

Position 6 (Electronics, Output)		
Selected option		Description
FTM5x	5	FEM55; 8/16 mA, 11-35 VDC
	7	FEM57; 2-wire PFM
	8	FEM58; NAMUR + test button (H-L signal)

Position 7 (Type of Probe)		
Selected option		Description
FTM5x	A	Compact
	D, E	Cable > separate enclosure
	G, H	Cable, armoured > separate enclosure

Position 8 (Housing)		
Selected option		Description
FTM5x	H	T13 Alu IP66/68 NEMA Type 4X/6P Encl., separate conn. compartment
	3	F17 Alu IP66/67 NEMA Type 4X Encl.
	5	F13 Alu IP66/68 NEMA Type 4X/6P Encl.
	6	F27 316L IP67/68 NEMA Type 4X/6P Encl.
	7	F15 316L hygiene IP66/67 NEMA Type 4X Encl.

Position 11 (Additional Option 2)		
Selected option		Description
FTM50 FTM51	A	Not selected
	C	EN10204-3.1 material (wetted parts), inspection certificate
	D, E	Temp. separator $\leq 150^{\circ}\text{C}$
	F, H	High temperature $\leq 280^{\circ}\text{C}$
	J, K	High temperature $\leq 230^{\circ}\text{C}$
	Y	Special version: High temperature $\leq 300^{\circ}\text{C}$
FTM52	A	Not selected

Optional specifications

No options specific to hazardous locations are available.

Safety instructions: General

- Staff must meet the following conditions for mounting, electrical installation, commissioning and maintenance of the device:
 - Be suitably qualified for their role and the tasks they perform
 - Be trained in explosion protection
 - Be familiar with national regulations
- Install the device according to the manufacturer's instructions and national regulations.
- Do not operate the device outside the specified electrical, thermal and mechanical parameters.
- Only use the device in media to which the wetted materials have sufficient durability.

- Avoid electrostatic charging:
 - Of plastic surfaces (e.g. enclosure, sensor element, special varnishing, attached additional plates, ..)
 - Of isolated capacities (e.g. isolated metallic plates)
- Refer to the temperature tables for the relationship between the permitted ambient temperature for the sensor and/or transmitter, depending on the range of application and the temperature class.
- Modifications to the device can affect the explosion protection and must be carried out by staff authorized to perform such work by Endress+Hauser.

**Safety
instructions:
Special conditions**

Permitted ambient temperature range at the electronics enclosure:
→  14, "Temperature tables".

- Observe the information in the temperature tables.
- To avoid electrostatic charging: Do not rub surfaces with a dry cloth.
- In the event of additional or alternative special varnishing on the enclosure or other metal parts or for adhesive plates:
 - Observe the danger of electrostatic charging and discharge.
 - Do not install in the vicinity of processes (≤ 0.5 m) generating strong electrostatic charges.

Basic specification, Position 7 = D, E, G, H

The probe version with separate enclosure is only suited for fixed installation.

Basic specification, Position 7 = D, E

Avoid electrostatic charging of the connecting cable between the separate enclosure and the sensor.

Basic specification, Position 7 = D, E and Basic specification, Position 8 = H, 3, 5

In Zone 0 not permitted.

Basic specification, Position 8 = H, 3, 5

Avoid sparks caused by impact and friction.

Safety instructions: Installation

Device type <i>Basic specification, Position 7 = A</i>	
FTM50, FTM51	II 1 D Ex ia IIIC Txx °C Da II 1 D Ex ia IIIC T ₂₀₀ Txx °C Da ¹⁾ II 1/2 D Ex ia IIIC Txx °C Da/Db II 1 G Ex ia IIC T6...T2 Ga ^{2) 3)} II 1 G Ex ia IIC T6...T3 Ga ^{2) 4)} II 1/2 G Ex ia IIC T6...T2 Ga/Gb ³⁾ II 1/2 G Ex ia IIC T6...T3 Ga/Gb ⁴⁾
FTM52	II 1 D Ex ia IIIC Txx °C Da II 1 D Ex ia IIIC T ₂₀₀ Txx °C Da ¹⁾ II 1/2 D Ex ia IIIC Txx °C Da/Db II 1 G Ex ia IIC T6 Ga ²⁾ II 1/2 G Ex ia IIC T6 Ga/Gb

- 1) Designation due to limited space only in this XA; not on the nameplate
- 2) Only in connection with Position 8 = 6, 7
- 3) Only in connection with Position 11 = F, H, J, K, Y
- 4) Only in connection with Position 11 = A, C, D, E

Device type <i>Basic specification, Position 7 = D, E</i>	
Electronics enclosure FTM5x	II 1 D (1) D Ex ia [ia Da] IIIC Txx °C Da II 1 D (1) D Ex ia [ia Da] IIIC T ₂₀₀ Txx °C Da ¹⁾ II 2 D (1) D Ex ia [ia Da] IIIC Txx °C Db II 2 D (2) D Ex ia [ia Db] IIIC Txx °C Db ¹⁾ II 2 D (2) G Ex ia [ia Gb] IIC T6 Gb ¹⁾ II 2 G (1) D Ex ia [ia Da] IIC T6 Gb ¹⁾ II 2 G (2) D Ex ia [ia Db] IIC T6 Gb ¹⁾ II 2 G (2) G Ex ia [ia Gb] IIC T6 Gb ¹⁾
Sensor enclosure FTM5x	II 1 D Ex ia IIIC Txx °C Da II 1 D Ex ia IIIC T ₂₀₀ Txx °C Da ¹⁾ II 1/2 D Ex ia IIIC Txx °C Da/Db ¹⁾
Sensor enclosure FTM50, FTM51	II 1/2 G Ex ia IIC T6...T2 Ga/Gb II 1/2 G Ex ia IIC T6...T3 Ga/Gb
Sensor enclosure FTM52	II 1/2 G Ex ia IIC T6 Ga/Gb

- 1) Designation due to limited space only in this XA; not on the nameplate

Device type <i>Basic specification, Position 7 = G, H</i>	
Electronics enclosure FTM5x	II 1 D (1) D Ex ia ia Da IIIC Txx °C Da II 1 D (1) D Ex ia ia Da IIIC T ₂₀₀ Txx °C Da ¹⁾ II 1 D (1) G Ex ia ia Ga IIIC Txx °C Da ¹⁾ II 2 D (1) D Ex ia ia Da IIIC Txx °C Db II 2 D (1) G Ex ia ia Ga IIIC Txx °C Db ¹⁾ II 2 D (2) D Ex ia ia Db IIIC Txx °C Db ¹⁾ II 2 D (2) G Ex ia ia Gb IIC T6 Gb ^{2) 1)} II 1 G (1) D Ex ia ia Da IIC T6 Ga ^{2) 1)} II 1 G (1) G Ex ia ia Ga IIC T6 Ga ²⁾ II 2 G (1) D Ex ia ia Da IIC T6 Gb ¹⁾ II 2 G (1) G Ex ia ia Ga IIC T6 Gb II 2 G (2) D Ex ia ia Db IIC T6 Gb ¹⁾ II 2 G (2) G Ex ia ia Gb IIC T6 Gb ¹⁾
Sensor enclosure FTM5x	II 1 D Ex ia IIIC Txx °C Da II 1 D Ex ia IIIC T ₂₀₀ Txx °C Da ¹⁾ II 1/2 D Ex ia IIIC Txx °C Da/Db ¹⁾
Sensor enclosure FTM50, FTM51	II 1 G Ex ia IIC T6...T2 Ga ³⁾ II 1 G Ex ia IIC T6...T3 Ga ⁴⁾ II 1/2 G Ex ia IIC T6...T2 Ga/Gb ^{1) 3)} II 1/2 G Ex ia IIC T6...T3 Ga/Gb ^{1) 4)}
Sensor enclosure FTM52	II 1 G Ex ia IIC T6 Ga II 1/2 G Ex ia IIC T6 Ga/Gb ¹⁾

- 1) Designation due to limited space only in this XA; not on the nameplate
- 2) Only in connection with Position 8 = 6, 7
- 3) Only in connection with Position 11 = F, H, J, K, Y
- 4) Only in connection with Position 11 = A, C

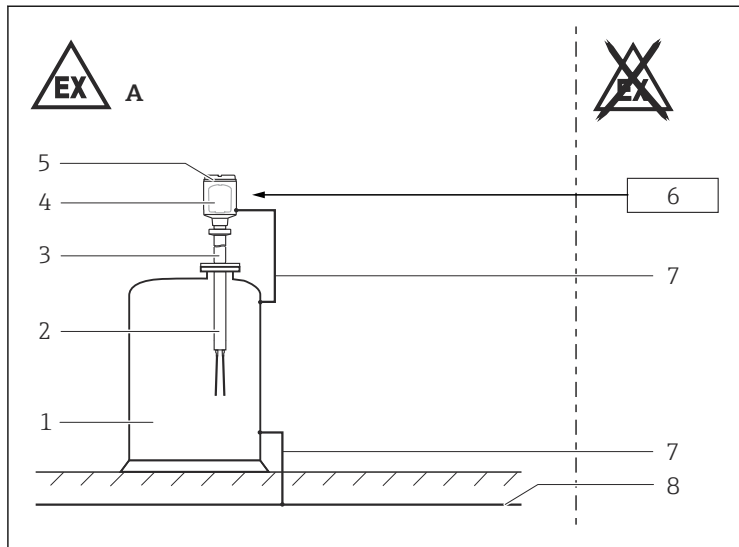

A0027391

1

- A Basic specification, Position 8 = 6, 7 and Position 7 = A:
 Zone 0, Zone 1, Zone 20 or Zone 21
 Basic specification, Position 8 = H, 3, 5 and Position 7 = A:
 Zone 1, Zone 20 or Zone 21
- 1 Tank, Hazardous area Zone 0, Zone 1, Zone 20 or Zone 21
 2 Version
 3 Temperature separator (optional at 150 °C)
 4 Electronic insert; Electronic compartment Ex ia
 5 Enclosure
 6 Power supply
 7 Potential equalization line
 8 Potential equalization

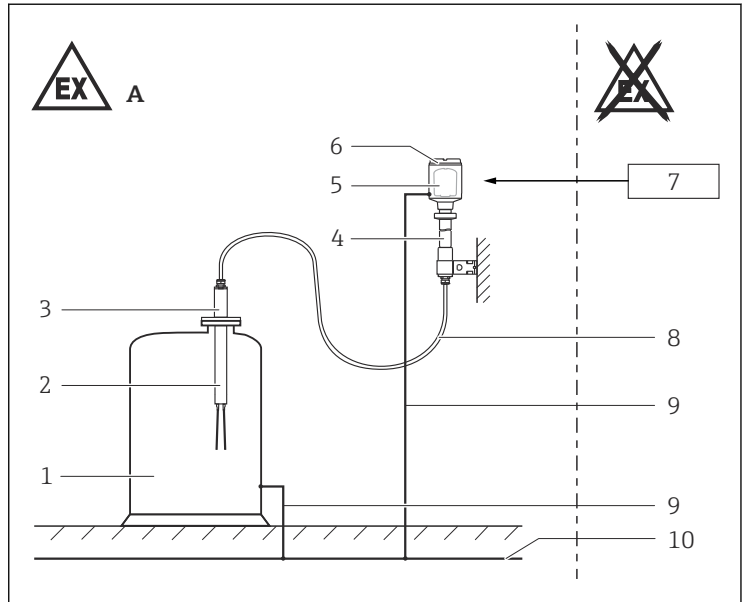

A0027407

2

- A** *Basic specification, Position 8 = 6, 7 and Position 7 = G, H:
Zone 0, Zone 1, Zone 20 or Zone 21
Basic specification, Position 8 = H, 3, 5 and Position 7 = D, E, G, H:
Zone 1, Zone 20 or Zone 21*
- 1 Tank, Hazardous area Zone 0, Zone 1, Zone 20 or Zone 21
 - 2 Version
 - 3 Sensor enclosure
 - 4 Temperature separator (optional at 150 °C)
 - 5 Electronic insert; Electronic compartment Ex ia
 - 6 Electronics enclosure
 - 7 Power supply
 - 8 Connecting cable
 - 9 Potential equalization line
 - 10 Potential equalization

- Connect the device using suitable cable and wire entries of protection type "Intrinsic safety (Ex i)".
- Seal unused entry glands with approved sealing plugs that correspond to the type of protection.
- Observe the maximum process conditions according to the manufacturer's Operating Instructions.
- At high medium temperatures, note flange pressure load capacity as a factor of temperature.

- Install the device to exclude any mechanical damage or friction during the application. Pay particular attention to flow conditions and tank fittings.
- Protect the connecting cable between the separate enclosure and the level sensor from tension and friction (e.g. due to electrostatic charge from medium flow).
- Use a process connection seal that meets the materials compatibility and temperature requirements.
- Support extension tube of the device if a dynamic load is expected.
- Continuous service temperature of the connecting cable:
–40 °C to $\geq +85$ °C; in accordance with the range of service temperature taking into account additional influences of the process conditions. For Zone 20 applications with complete immersion
 $T_{a,max} + 35$ K.

Basic specification, Position 8 = 3, 6, 7

Perform the following to achieve the degree of protection IP66/67:

- Screw the cover tight.
- Mount the cable entry correctly.

Basic specification, Position 8 = H, 5

Perform the following to achieve the degree of protection IP66/68:

- Screw the cover tight.
- Mount the cable entry correctly.

Accessory high pressure sliding sleeve

The high pressure sliding sleeve can be used for a continuous setting of the switch point and is suited for zone separation if mounted properly (see Operating Instructions).

Application in gas

- When using under non-atmospheric pressures and non-atmospheric temperatures: The sensor part of the device approved for Zone 0 does not cause any ignition hazards.
- For operation in accordance with manufacturer's specifications:
 - Permissible medium temperatures: dependent on ambient temperature
 - Permissible pressures: –1 to +25 bar (FTM50/51), –1 to +2 bar (FTM52), dependent on process connection (see Operating Instructions).

Intrinsic safety

- The device is only suitable for connection to certified, intrinsically safe equipment with explosion protection Ex ia.
- The intrinsically safe input power circuit of the device is isolated from ground. The dielectric strength is at least 500 V_{rms}.
- Observe the pertinent guidelines when interconnecting intrinsically safe circuits.

Potential equalization

Integrate the device into the local potential equalization.

Safety instructions: Zone 0

- In the event of potentially explosive vapor/air mixtures, only operate the device under atmospheric conditions.
 - Temperature: -20 to +60 °C
 - Pressure: 80 to 110 kPa (0.8 to 1.1 bar)
 - Air with normal oxygen content, usually 21 % (V/V)
- If no potentially explosive mixtures are present, or if additional protective measures have been taken, the device may also be operated under non-atmospheric conditions in accordance with the manufacturer's specifications.
- Associated devices with galvanic isolation between the intrinsically safe and non-intrinsically safe circuits are preferred.
- Only use the device in media to which the silicone rubber potting compound of the electronic insert and the enclosure made of 316L have sufficient durability.
- Only use the device in media to which the wetted materials have sufficient durability (e.g. process connection seal).
- If used under non-atmospheric conditions and if the manufacturer's specifications are observed: The sensor approved for the pressure vessel (Zone 0) does not cause any ignition hazards.

Safety instructions: Zone 0, Zone 20

The device is designed for operation in Zone 0 or Zone 20. In the event of potentially explosive gas-air and dust-air mixtures occurring simultaneously: Suitability requires further assessment.

Temperature tables

Description notes

Column P1 to P5: Position (temperature value) on the axes of the derating

- T_a : Ambient temperature in °C
- T_p : Process temperature in °C

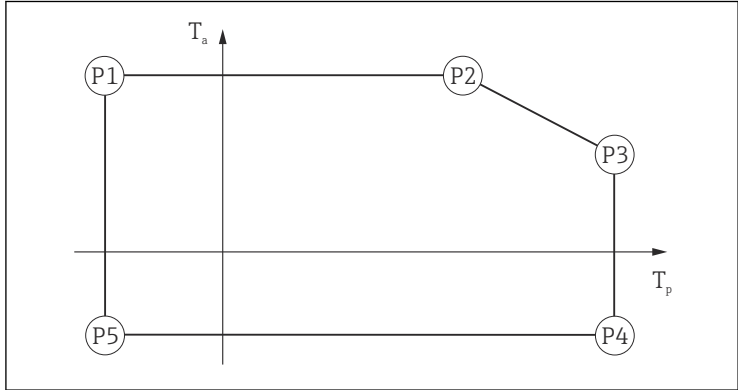

A0033052

Application in gas

Device type FTM50, FTM51

Basic specification, Position 7 = A

Temperature class	P1		P2		P3		P4		P5	
	T_p	T_a	T_p	T_a	T_p	T_a	T_p	T_a	T_p	T_a
T6	-50	55	55	55	80	40	80	-40 ¹⁾	-50	-40 ¹⁾
T5...T1	-50	55	55	55	85	40	85	-40 ¹⁾	-50	-40 ¹⁾

- 1) Basic specification, Position 8 = H, 5, 6: -50 °C

Basic specification, Position 11 = D, E

Temperature class	P1		P2		P3		P4		P5	
	T_p	T_a	T_p	T_a	T_p	T_a	T_p	T_a	T_p	T_a
T6	-50	55	55	55	80	50	80	-40 ¹⁾	-50	-40 ¹⁾
T5	-50	55	55	55	95	50	95	-40 ¹⁾	-50	-40 ¹⁾
T4	-50	55	55	55	130	45	130	-40 ¹⁾	-50	-40 ¹⁾
T3...T1	-50	55	55	55	150	45	150	-40 ¹⁾	-50	-40 ¹⁾

- 1) Basic specification, Position 8 = H, 5, 6: -50 °C

Basic specification, Position 11 = J, K

Temperature class	P1		P2		P3		P4		P5	
	T _p	T _a	T _p	T _a	T _p	T _a	T _p	T _a	T _p	T _a
T6	-50	55	55	55	80	50	80	-40 ¹⁾	-50	-40 ¹⁾
T5	-50	55	55	55	95	50	95	-40 ¹⁾	-50	-40 ¹⁾
T4	-50	55	55	55	130	50	130	-40 ¹⁾	-50	-40 ¹⁾
T3	-50	55	55	55	195	45	195	-40 ¹⁾	-50	-40 ¹⁾
T2...T1	-50	55	55	55	230	40	130	-40 ¹⁾	-50	-40 ¹⁾

1) Basic specification, Position 8 = H, 5, 6: -50 °C

Basic specification, Position 11 = F, H, Y

Temperature class	P1		P2		P3		P4		P5	
	T _p	T _a	T _p	T _a	T _p	T _a	T _p	T _a	T _p	T _a
T6	-50	55	55	55	80	50	80	-40 ¹⁾	-50	-40 ¹⁾
T5	-50	55	55	55	95	50	95	-40 ¹⁾	-50	-40 ¹⁾
T4	-50	55	55	55	130	50	130	-40 ¹⁾	-50	-40 ¹⁾
T3	-50	55	55	55	195	45	195	-40 ¹⁾	-50	-40 ¹⁾
T2	-50	55	55	55	280	45	280	-40 ¹⁾	-50	-40 ¹⁾
T1	-50	55	55	55	300	45	300	-40 ¹⁾	-50	-40 ¹⁾

1) Basic specification, Position 8 = H, 5, 6: -50 °C

Device type FTM52

Temperature class	P1		P2		P3		P4		P5	
	T _p	T _a	T _p	T _a	T _p	T _a	T _p	T _a	T _p	T _a
T6...T1	-40	55	55	55	80	40	80	-40	-40	-40

Application in dust

Device type	Basic specification, Position	P1		P2		P3		P4		P5	
		T _p	T _a	T _p	T _a	T _p	T _a	T _p	T _a	T _p	T _a
FTM50, FTM51	7 = A	-50	55	60	55	100	40	100	-40 ¹⁾	-50	-40 ¹⁾
FTM50, FTM51	11 = D, E	-50	55	95	55	150	50	150	-40 ¹⁾	-50	-40 ¹⁾
FTM50, FTM51	11 = J, K	-50	55	110	55	230	45	230	-40 ¹⁾	-50	-40 ¹⁾
FTM50, FTM51	11 = F, H	-50	55	135	55	280	45	280	-40 ¹⁾	-50	-40 ¹⁾
FTM50, FTM51	11 = Y	-50	55	135	55	300	45	300	-40 ¹⁾	-50	-40 ¹⁾
FTM52		-40	55	65	55	80	45	80	-40	-40	-40

1) Basic specification, Position 8 = H, 5, 6: -50 °C

Temperatures with dust layer

Deposited material with a layer up to 5 mm

Device type	Surface temperature T	Ambient temperature: probe with Basic specification, Position 7 = D, E, G, H
FTM50, FTM51	Sensor: T _{p,max} +5 K	max. 120 °C
FTM52	Enclosure: T _{a,max} +5 K	max. 80 °C

Device type	Basic specification, Position	P1		P2		P3		P4		P5	
		T _p	T _a	T _p	T _a	T _p	T _a	T _p	T _a	T _p	T _a
FTM50, FTM51	7 = A	-50	55	60	55	100	35	100	-40 ¹⁾	-50	-40 ¹⁾
FTM50, FTM51	11 = D, E	-50	55	85	55	150	45	150	-40 ¹⁾	-50	-40 ¹⁾
FTM50, FTM51	11 = J, K	-50	55	100	55	230	45	230	-40 ¹⁾	-50	-40 ¹⁾
FTM50, FTM51	11 = F, H	-50	55	120	55	280	45	280	-40 ¹⁾	-50	-40 ¹⁾
FTM50, FTM51	11 = Y	-50	55	120	55	300	45	300	-40 ¹⁾	-50	-40 ¹⁾
FTM52		-40	55	60	55	80	45	80	-40	-40	-40

1) Basic specification, Position 8 = H, 5, 6: -50 °C

Deposited material with a layer of 200 nm

Device type	Surface temperature T_{200}	Ambient temperature: probe with Basic specification, Position 7 = D, E, G, H
FTM50, FTM51	T 70 °C	max. 120 °C
FTM52		max. 80 °C

Device type	Basic specification, Position	P1		P2		P3		P4		P5	
		T_p	T_a	T_p	T_a	T_p	T_a	T_p	T_a	T_p	T_a
FTM50, FTM51	7 = A	-40 ¹⁾	33	33	33	33	33	33	-40 ¹⁾	-40 ¹⁾	-40 ¹⁾
FTM50, FTM51	11 = D, E, J, K, F, H, Y	-40 ¹⁾	33	33	33	33	33	33	-40 ¹⁾	-40 ¹⁾	-40 ¹⁾
FTM52		-40	33	33	33	33	33	33	-40	-40	-40

1) Basic specification, Position 8 = H, 5, 6: -50 °C

Connection data

Basic specification, Position 6	Power supply
= 5	$U_i = 35 \text{ V}$ $I_i = 100 \text{ mA}$ $P_i = 1 \text{ W}$ $L_i = 0$ $C_i = 0$
= 7	$U_i = 16.7 \text{ V}$ $I_i = 150 \text{ mA}$ $P_i = 1 \text{ W}$ $L_i = 0$ $C_i = 0$
= 8	$U_i = 18 \text{ V}$ $I_i = 52 \text{ mA}$ $P_i = 170 \text{ mW}$ $L_i = 0$ $C_i = 30 \text{ nF}$



71530072

www.addresses.endress.com
