

Brief Operating Instructions

RNO22

1- or 2-channel output isolating amplifier 24 V DC,
HART transparent



These Instructions are Brief Operating Instructions; they are not a substitute for the Operating Instructions pertaining to the device.

For detailed information, refer to the Operating Instructions and other documentation.





Available for all device versions via:

- Internet: www.endress.com/deviceviewer
- Smart phone/Tablet: Endress+Hauser Operations App











1 About this document

1.1 Symbols





1.1.1 Safety symbols

 DANGER This symbol alerts you to a dangerous situation. Failure to avoid this situation will result in serious or fatal injury.	 WARNING This symbol alerts you to a dangerous situation. Failure to avoid this situation can result in serious or fatal injury.
 CAUTION This symbol alerts you to a dangerous situation. Failure to avoid this situation can result in minor or medium injury.	 NOTICE This symbol contains information on procedures and other facts which do not result in personal injury.

1.1.2 Symbols for certain types of information

Symbol	Meaning	Symbol	Meaning
	Permitted Procedures, processes or actions that are permitted.		Preferred Procedures, processes or actions that are preferred.
	Forbidden Procedures, processes or actions that are forbidden.		Tip Indicates additional information.
	Reference to documentation		Reference to page
	Reference to graphic		Series of steps
	Result of a step		Visual inspection

1.1.3 Electrical symbols

	Direct current		Alternating current
	Direct current and alternating current		Ground connection A grounded terminal which, as far as the operator is concerned, is grounded via a grounding system.

1.1.4 Symbols in graphics

	Item numbers		Views
--	--------------	---	-------

1.1.5 Symbols at the device

	<p>Warning Observe the safety instructions contained in the associated Operating Instructions</p>
---	--

1.2 Registered trademarks

HART®

Registered trademark of the FieldComm Group, Austin, Texas, USA

2 Basic safety instructions

2.1 Requirements for the personnel

The personnel must fulfill the following requirements for its tasks:

- ▶ Trained, qualified specialists must have a relevant qualification for this specific function and task.
- ▶ Are authorized by the plant owner/operator.
- ▶ Are familiar with federal/national regulations.
- ▶ Before starting work, read and understand the instructions in the manual and supplementary documentation as well as the certificates (depending on the application).
- ▶ Follow instructions and comply with basic conditions.

2.2 Designated use

2.2.1 Output isolating amplifier

The output isolating amplifier is used to control I/P transducers, control valves and display units. The device separates and transmits 0/4 to 20 mA signals. For operating the SMART actuators, the analog measuring value can be overlaid with digital communication signals (HART) and transmitted bidirectionally in an electrically isolated manner. The device enables open-circuit and short-circuit monitoring. An intrinsically safe version is optionally available for operation in Zone 2. The device is designed for installation on DIN rails in accordance with IEC 60715.

2.2.2 Product liability

The manufacturer does not accept any responsibility for damage that results from non-designated use and from failure to comply with the instructions in this manual.

2.3 Workplace safety

For work on and with the device:

- ▶ Wear the required personal protective equipment according to federal/national regulations.

2.4 Operational safety

Risk of injury!

- ▶ Operate the device only if it is in proper technical condition, free from errors and faults.
- ▶ The operator is responsible for interference-free operation of the device.

Hazardous area

To eliminate danger to persons or the facility when the device is used in the hazardous area (e.g. explosion protection):

- ▶ Check the nameplate to verify if the device ordered can be put to its intended use in the hazardous area.
- ▶ Observe the specifications in the separate supplementary documentation that is an integral part of these instructions.

2.5 Product safety

This device is designed in accordance with good engineering practice to meet state-of-the-art safety requirements, has been tested, and left the factory in a condition in which it is safe to operate.

2.6 Installation instructions

- The device's IP20 degree of protection is intended for a clean and dry environment.
- Do not expose the device to mechanical and/or thermal stress that exceeds the specified limits.
- The device is intended for installation in a cabinet or similar housing. The device may only be operated as an installed device.
The cabinet must meet the fire protection housing requirements according to safety standard UL/IEC 61010-1 and provide adequate protection against electric shock or burns.
- To protect against mechanical or electrical damage, the device must be installed in an appropriate housing with a suitable degree of protection according to IEC/EN 60529.
- During installation, repair and maintenance work, the device must be disconnected from all effective power sources if the power sources are not SELV or PELV circuits.
- Only use copper cables as the connection cable.
- A SELV/PELV power unit with a nominal voltage of $24 V_{DC}$ (max. $30 V_{DC}$) is required for the external device power supply.

3 Product description

3.1 Product design

3.1.1 Output isolating amplifier, 1-channel

- With the "1-channel" option, the output isolating amplifier is used to control I/P converters, control valves and indicators. The device separates and transmits 0/4 to 20 mA signals. For operating the SMART actuators, the analog measuring value can be overlaid with digital communication signals (HART) and transmitted bidirectionally in an electrically isolated manner.
- Sockets for the connection of HART communicators are integrated in the plug-in connectors. The device enables open-circuit and short-circuit monitoring. Short-circuit monitoring can be switched off or on using the DIP switches. An open or shorted field circuit causes a high input impedance on the controller side. This enables open-circuit and short-circuit monitoring by the control system. A green LED indicates that the device is ready for operation.
- The device is optionally available with Ex approvals for the intrinsically safe operation of I/P converters, control valves and indicators installed in the hazardous area. Separate Ex documentation (XA) is supplied with these devices. Compliance with the installation instructions and connection data in this documentation is mandatory!

3.1.2 Output isolating amplifier, 2-channel

With the "2-channel" option, the device has a second channel, which is galvanically isolated from channel 1, while maintaining the same width. In the 2-channel version, short-circuit monitoring **cannot** be switched off or on using the DIP switches. Otherwise, the function corresponds to the 1-channel device.

4 Incoming acceptance and product identification

4.1 Incoming acceptance

Check the following during incoming acceptance:

- Are the order codes on the delivery note and the product sticker identical?
- Are the goods undamaged?
- Do the nameplate data match the ordering information on the delivery note?



If one of these conditions is not met, please contact the manufacturer's sales office.

4.2 Product identification

The following options are available for identification of the device:

- Nameplate specifications
- Extended order code with breakdown of the device features on the delivery note

4.2.1 Name and address of manufacturer

Name of manufacturer:	Endress+Hauser Wetzer GmbH + Co. KG
Address of manufacturer:	Obere Wank 1, D-87484 Nesselwang
Model/type reference:	RNO22

4.3 Certificates and approvals



For certificates and approvals valid for the device: see the data on the nameplate



Approval-related data and documents: www.endress.com/deviceviewer → (enter the serial number)

4.3.1 Functional safety

A SIL version of the device is optionally available. It can be used in safety equipment in accordance with IEC 61508 up to SIL 2 (SC 3).



Please refer to Safety Manual FY01037K for the use of the device in safety instrumented systems according to IEC 61508.



Protection against modifications:

As it is not possible to disengage the operating elements (keys and DIP switches), a lockable control cabinet is required for use in SIL applications. The cabinet must be locked by key. A normal electrical cabinet key does not suffice for this purpose.

5 Installation

5.1 Installation conditions

5.1.1 Mounting location

The device is designed for installation on 35 mm (1.38 in) DIN rails in accordance with IEC 60715 (TH35).

The device's housing provides basic insulation from neighboring devices for 300 Veff. If several devices are installed side by side, this must be taken into consideration and additional insulation must be provided if necessary. If the adjacent device also offers basic insulation, no additional insulation is required.

NOTICE

- ▶ When using in hazardous areas, the limit values of the certificates and approvals must be observed.

5.2 Important ambient conditions

Ambient temperature range	-40 to 70 °C (-40 to 158 °F)	Storage temperature	-40 to 85 °C (-40 to 185 °F)
Degree of protection	IP 20	Overvoltage category	II
Pollution degree	2	Humidity	10 to 95 % No condensation
Altitude	≤ 2 000 m (6 562 ft)		

5.3 Installing the DIN rail bus connector

i If using the DIN rail bus connector for the power supply, clip it onto the DIN rail BEFORE mounting the device. Pay attention to the orientation of the module and DIN rail bus connector when doing so: the snap-on clip should be at the bottom and the connector piece on the left!

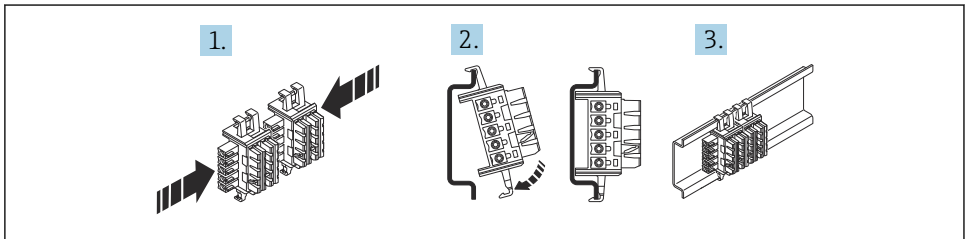

A0041738

i 1 *Installing the DIN rail bus connector 12.5 mm (0.5 in)*

5.4 Installing a DIN rail device

The device can be installed in any position (horizontal or vertical) on the DIN rail without lateral clearance from neighboring devices. No tools are required for installation. The use of end brackets (type "WEW 35/1" or similar) on the DIN rail is recommended to fix the device.

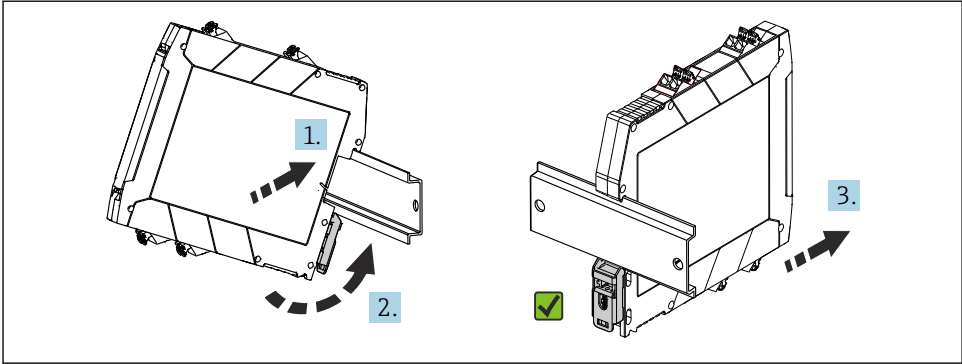

A0041736

2 Installing on DIN rail

6 Electrical connection

6.1 Connection conditions

A flat-blade screwdriver is required to establish an electrical connection to screw or push-in terminals.

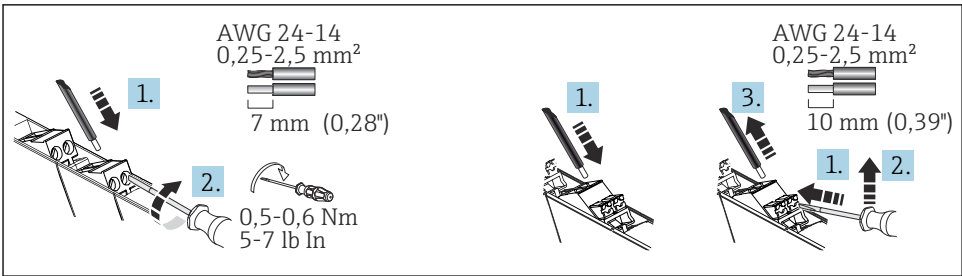

A0040201

3 Electrical connection using screw terminals (left) and push-in terminals (right)

CAUTION

Destruction of parts of the electronics

- Switch off power supply before installing or connecting the device.

NOTICE

Destruction or malfunction of parts of the electronics

- ⚡ ESD - electrostatic discharge. Protect the terminals from electrostatic discharge.

6.1.1 Special connection instructions

- Disconnecting units and auxiliary circuit protective systems with suitable AC or DC values must be provided in the building installation.
- A switch/power circuit breaker must be provided close to the device and clearly marked as a disconnecting unit for this device.
- An overcurrent protection unit ($I \leq 16 \text{ A}$) must be provided in the installation.
- The voltages applied at the input and power supply are all extra-low voltages (ELV). Depending on the application, the switching voltage at the relay output can be a dangerous voltage ($>30 V_{AV} / >60 V_{DC}$). Safe galvanic isolation between the input and output side is provided for this scenario.

6.2 Important connection data

Power supply

Supply voltage	$24 V_{DC} (-20\% / +25\%)$	Maximum current consumption at $24 V_{DC} / 20 \text{ mA}$	1-channel: $<45 \text{ mA}$ 2-channel: $<85 \text{ mA}$
Supply current to the DIN rail bus connector	max. 400 mA	Maximum power consumption at $24 V_{DC} / 20 \text{ mA}$	1-channel: $\leq 1.1 \text{ W}$ 2-channel: $<2 \text{ W}$
		Power loss at $24 V_{DC} / 20 \text{ mA}$	1-channel: $<0.8 \text{ W}$ 2-channel: $<1.4 \text{ W}$

Input data

Current input signal: Function (short-circuit detection off; 1-channel only) Function (short-circuit detection on; 1-channel only) Safety Underload/overload range	0 to 20 mA 0.2 to 20 mA 4 to 20 mA 0 to 24 mA
Line fault detection: input current response threshold	$> 0.2 \text{ mA}$

Output data

Current output signal: Function (short-circuit detection off; 1-channel only) Function (short-circuit detection on; 1-channel only) Safety Underload/overload range	0 to 20 mA 0.2 to 20 mA 4 to 20 mA 0 to 24 mA
Open-circuit voltage	$\leq 27 \text{ V}$
Transmission behavior	1:1 to input signal
Load: Short-circuit detection on ($20 / 24 \text{ mA}$) Short-circuit detection off ($20 / 24 \text{ mA}$)	100 to $700 \Omega / 500 \Omega$ 0 to $700 \Omega / 500 \Omega$
Transmissible communication protocols	HART

Accuracies

Transmission error (typical / maximum)	0.05 % / 0.1 % of full scale value
Temperature coefficient (typical / maximum)	≤0.005 % / 0.01 %/K

Galvanic isolation

Output / input; output / power supply (peak value according to EN 60079-11)	375 V
Output 1 / output 2 (2-channel devices)	60 V



For detailed technical data, see the Operating Instructions

6.3 Quick wiring guide

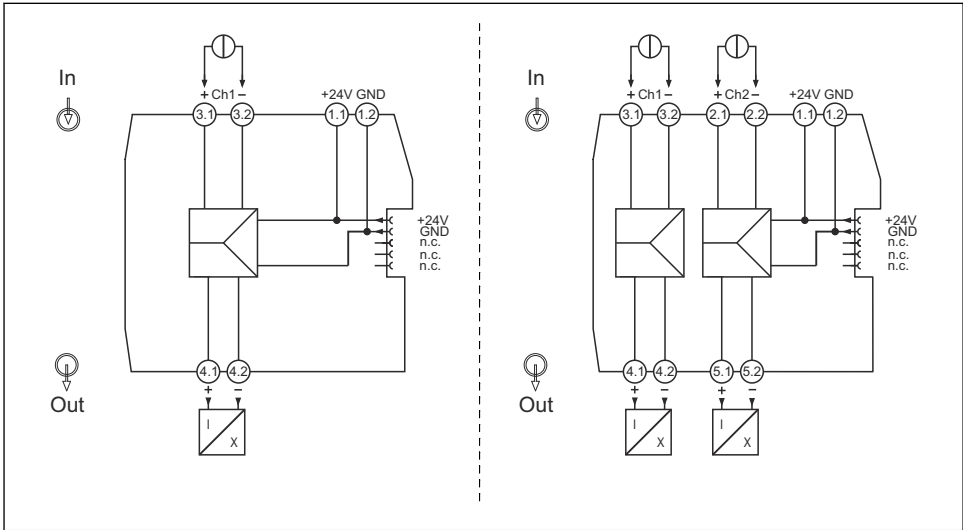

A0043882

4 Terminal assignment of RNO22: 1-channel version (left), 2-channel version (right)

6.4 Power supply

Power can be supplied via terminals 1.1 and 1.2 or via the DIN rail bus connector.

NOTICE

The simultaneous use of terminals and DIN rail bus connectors to supply power is not permitted! The tapping of energy from the DIN rail bus connector for further distribution is not permitted.

- The supply voltage must never be connected directly to the DIN rail bus connector!

6.4.1 Supply to the DIN rail bus connector via terminals

Devices installed side by side can be powered via the terminals of the device up to a total current consumption of 400 mA. The connection is via the DIN rail bus connector. The installation of a 630 mA fuse (semi-delay or slow-blow) upstream is recommended.

6.4.2 Using the power and error message module to supply power

It is recommended to use the RNF22 power and error message module to provide the supply voltage to the DIN rail bus connector.

6.5 Post-connection check

Device condition and specifications	Notes
Are the device or cables free from damage (visual check)?	--
Do the ambient conditions match the device specification (e.g. ambient temperature, measuring range, etc.)?	See "Technical data"
Electrical connection	Notes
Does the supply voltage match the information on the nameplate?	U = e.g. 19.2 to 30 V _{DC}  The device may only be powered by a power unit with an energy-limited circuit.
Are the power supply and signal cables connected correctly?	--
Are all the screw terminals well tightened and have the connections of the push-in terminals been checked?	--

7 Display and operating elements

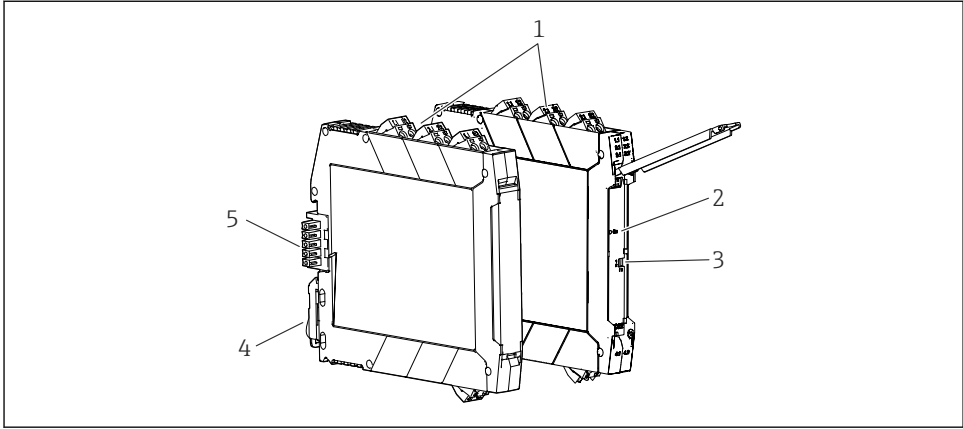

A0043926

5 Display and operating elements

- 1 Plug-in screw or push-in terminal with integrated test socket
- 2 Green LED "PWR" power supply
- 3 DIP switches (only on 1-channel version)
- 4 DIN rail clip for DIN rail mounting
- 5 DIN rail bus connector (optional)

7.1 Local operation

7.1.1 Hardware settings / configuration

 Any device settings using the DIP switch must be made when the device is de-energized.

 For details refer to the Operating Instructions

7.1.2 Short-circuit detection

In the 1-channel version, short-circuit monitoring can be switched off or on using the DIP switches.

DIP switch	Short-circuit detection Off	Short-circuit detection On
1	I	II
2	I	II

 Short-circuit detection must be disabled for 0 to 20 mA signal transmission.

Otherwise, the signal range can only be used as of the line fault detection response threshold of >0.2 mA.

8 Commissioning

8.1 Post-installation check

Before commissioning the device, ensure that all installation and post-connection checks have been carried out.

NOTICE

- ▶ Before commissioning the device, make sure that the supply voltage matches the voltage specifications on the nameplate. Failure to perform these checks may result in damage to the device caused by the incorrect supply voltage.

8.2 Switching on the device

Switch on supply voltage. The green LED display on the front of the device indicates that the device is operational.

9 Maintenance

No special maintenance work is required for the device.

Cleaning

A clean, dry cloth can be used to clean the device.



71501875

www.addresses.endress.com
