

Safety Instructions

Gammapilot M FMG60

4-20 mA HART

Ex db eb [ia Ga] IIC T6...T5 Gb

Ex db eb [ia Ga] IIC T6 Gb

Ex db [ia Ga] IIC T6...T5 Gb

Ex db [ia Ga] IIC T6 Gb



Gammapilot M FMG60

4-20 mA HART

Table of contents

Associated documentation	4
Supplementary documentation	4
Manufacturer's certificates	4
Manufacturer address	4
Other standards	4
Extended order code	4
Safety instructions: General	7
Safety instructions: Special conditions	7
Safety instructions: Installation	7
Temperature tables	11
Connection data	12

Associated documentation	<p>This document is an integral part of the following Operating Instructions: BA00236F/00</p>
Supplementary documentation	<p>Explosion-protection brochure: CP00021Z/11 The Explosion-protection brochure is available:</p> <ul style="list-style-type: none">▪ In the download area of the Endress+Hauser website: www.endress.com -> Downloads -> Brochures and Catalogs -> Text Search: CP00021Z▪ On the CD for devices with CD-based documentation
Manufacturer's certificates	<p>IEC Declaration of Conformity</p> <p>Certificate number: IECEX DEK 13.0071X</p> <p>Affixing the certificate number certifies conformity with the following standards (depending on the device version):</p> <ul style="list-style-type: none">▪ IEC 60079-0 : 2017▪ IEC 60079-1 : 2014▪ IEC 60079-7 : 2017▪ IEC 60079-11 : 2011
Manufacturer address	<p>Endress+Hauser SE+Co. KG Hauptstraße 1 79689 Maulburg, Germany Address of the manufacturing plant: See nameplate.</p>
Other standards	<p>Among other things, the following standards shall be observed in their current version for proper installation:</p> <ul style="list-style-type: none">▪ IEC/EN 60079-14: "Explosive atmospheres - Part 14: Electrical installations design, selection and erection"▪ EN 1127-1: "Explosive atmospheres - Explosion prevention and protection - Part 1: Basic concepts and methodology"
Extended order code	<p>The extended order code is indicated on the nameplate, which is affixed to the device in such a way that it is clearly visible. Additional information about the nameplate is provided in the associated Operating Instructions.</p>

Structure of the extended order code

FMG60	–	*****	+	A*B*C*D*E*F*G*..
<i>(Device type)</i>		<i>(Basic specifications)</i>		<i>(Optional specifications)</i>

* = Placeholder

At this position, an option (number or letter) selected from the specification is displayed instead of the placeholders.

Basic specifications

The features that are absolutely essential for the device (mandatory features) are specified in the basic specifications. The number of positions depends on the number of features available.

The selected option of a feature can consist of several positions.

Optional specifications

The optional specifications describe additional features for the device (optional features). The number of positions depends on the number of features available. The features have a 2-digit structure to aid identification (e.g. JA). The first digit (ID) stands for the feature group and consists of a number or a letter (e.g. J = Test, Certificate). The second digit constitutes the value that stands for the feature within the group (e.g. A = 3.1 material (wetted parts), inspection certificate).

More detailed information about the device is provided in the following tables. These tables describe the individual positions and IDs in the extended order code which are relevant to hazardous locations.

Extended order code: Gammapilot M



The following specifications reproduce an extract from the product structure and are used to assign:

- This documentation to the device (using the extended order code on the nameplate).
- The device options cited in the document.

Device type

FMG60

Basic specifications

Position 1 (Approval)		
Selected option		Description
FMG60	G	IECEX Ex db eb [ia Ga] IIC T6 Gb
	H	IECEX Ex db [ia Ga] IIC T6 Gb

Position 2 (Power Supply)		
Selected option		Description
FMG60	1	90-253 VAC
	2	18-35 VDC

Position 3 (Connect. Power Supply; Connect. Output)		
Selected option		Description
FMG60	B	Ex eb; Ex ia
	C	Ex eb; Ex eb
	D	Ex db (XP); Ex db (XP)
	E	Ex db (XP); Ex ia (IS)

Position 4 (Output)		
Selected option		Description
FMG60	1	4-20 mA HART

Position 5 (Scintillator; Measuring Range)		
Selected option		Description
FMG60	A-D	NaJ-Crystal
	G-T	PVT

Optional specifications

No options specific to hazardous locations are available.

Safety instructions:
General

- Comply with the installation and safety instructions in the Operating Instructions.
- Staff must meet the following conditions for mounting, electrical installation, commissioning and maintenance of the device:
 - Be suitably qualified for their role and the tasks they perform
 - Be trained in explosion protection
 - Be familiar with national regulations
- Install the device according to the manufacturer's instructions and national regulations.
- Do not operate the device outside the specified electrical, thermal and mechanical parameters.
- Avoid electrostatic charging:
 - Of plastic surfaces (e.g. housing, sensor element, special varnishing, attached additional plates, ..)
 - Of isolated capacities (e.g. isolated metallic plates)

Safety instructions:
Special conditions

In the event of additional or alternative special varnishing on the housing or other metal parts:

- Observe the danger of electrostatic charging and discharge.
- Do not rub surfaces with a dry cloth.
- Do not install in the vicinity of processes generating strong electrostatic charges.

Safety instructions:
Installation

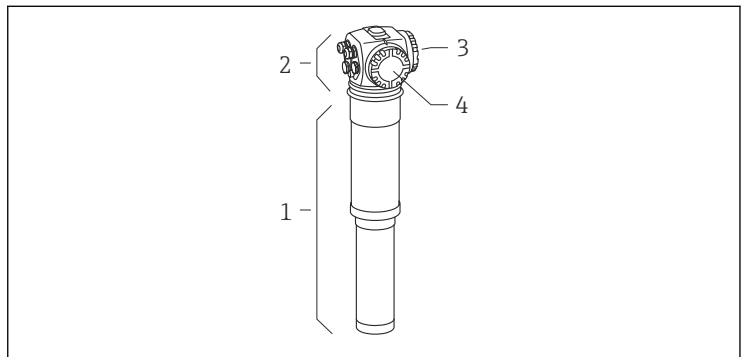

A0031753

- 1 Pipe housing
- 2 Compartment housing
- 3 Terminal compartment A
- 4 Terminal compartment B

**Circuit 4...20 mA/HART (active) in type of protection
Intrinsic safety (Ex ia)**

Basic specification, Position 3 = B, E

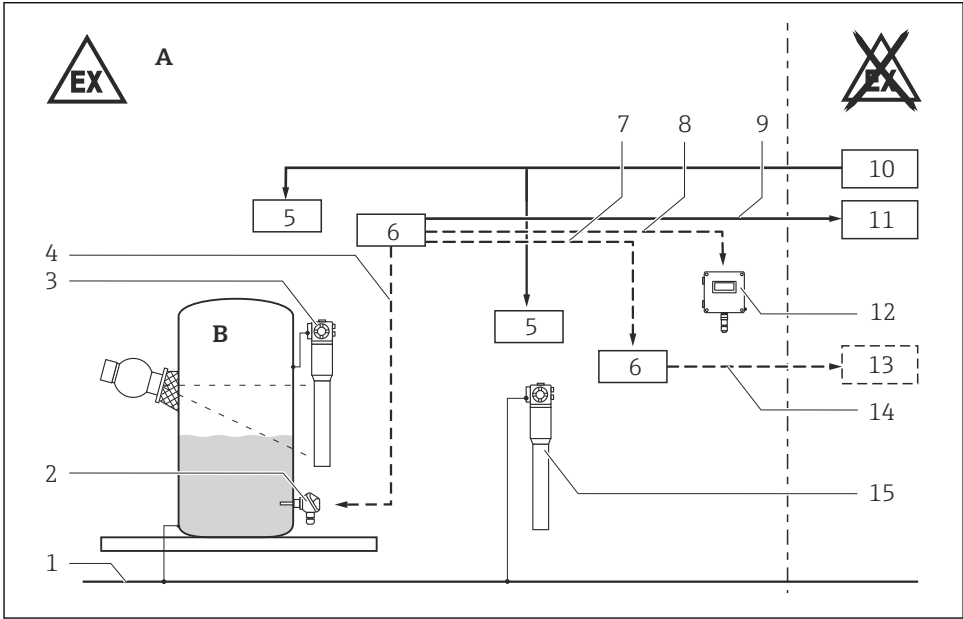

A0031754

- A Zone 1 or Zone 2
- B Zone 0, Zone 1 or Zone 2
- 1 Local potential equalization line
- 2 PT100; approved Ex ia equipment
- 3 FMG60 with NaJ crystal scintillator, PVT plastic scintillator
- 4 [Ex ia] circuit
- 5 Terminal compartment A (Ex db or Ex eb)
- 6 Terminal compartment B (Ex i)
- 7 [Ex ia] circuit; Cascade in, out
- 8 [Ex ia] circuit
- 9 Communication: 4...20 mA/HART active [Ex ia]
- 10 Power supply
- 11 Certified associated apparatus
- 12 Remote display FHX40
- 13 Certified associated apparatus
- 14 Communication: 4...20 mA/HART active [Ex ia]
- 15 FMG60 with NaJ crystal scintillator, PVT plastic scintillator

**Circuit 4...20 mA/HART (active) in type of protection
Increased safety (Ex eb) or Flameproof enclosure (Ex db)**
Basic specification, Position 3 = C, D

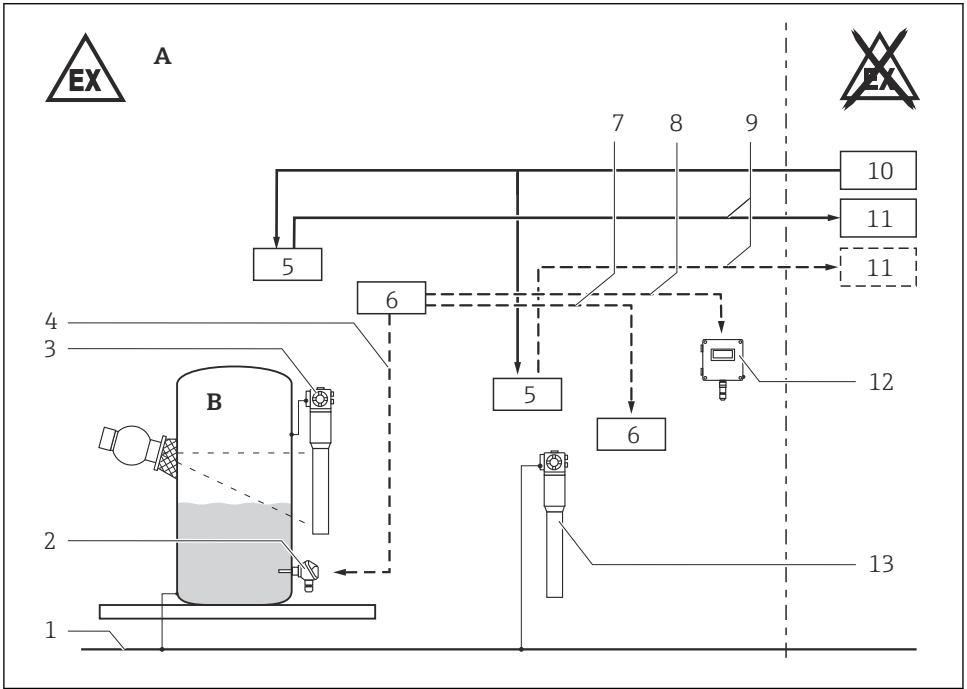

A0031755

- A Zone 1 or Zone 2
- B Zone 0, Zone 1 or Zone 2
- 1 Local potential equalization line
- 2 PT100; approved Ex ia equipment
- 3 FMG60 with NaJ crystal scintillator, PVT plastic scintillator
- 4 [Ex ia] circuit
- 5 Terminal compartment A (Ex db or Ex eb)
- 6 Terminal compartment B (Ex i)
- 7 [Ex ia] circuit; Cascade in, out
- 8 [Ex ia] circuit
- 9 Communication: 4...20 mA/HART active
- 10 Power supply
- 11 E.g. transmitter
- 12 Remote display FHX40
- 13 FMG60 with NaJ crystal scintillator, PVT plastic scintillator

- To maintain the ingress protection of the housing IP65/67: Install the housing cover, cable glands and blind plugs correctly.
- Cable glands as well as sealing plugs of the terminal compartment A must not be exchanged with those of the terminal compartment B.
- Do not open the terminal compartment A when energized.
- In an explosive atmosphere: Minimum waiting time before opening the terminal compartment A after switching off the power supply: 3 minutes.
- Before operation:
 - Screw in the cover all the way.
 - Tighten the securing clamp on the cover.
- Continuous service temperature of the connecting cable: $\geq T_a + 20 \text{ K}$.

The safety screws at the pipe housing must not be loosened:

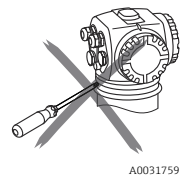

When using the water cooling

To avoid damages at the detector or at the cooling jacket if the cooling water freezes: Empty cooling jacket or protect against freezing.

Intrinsic safety

- Observe the pertinent guidelines when interconnecting intrinsically safe circuits.
- The intrinsically-safe input circuits are galvanically isolated from other circuits up to a peak value of the nominal voltage of 375 V.
- The intrinsically safe circuits of the device are isolated from ground and have a dielectric strength of at least $500 V_{\text{rms}}$.
- When the device is connected to an intrinsically safe circuit Ex ib, the type of protection changes to Ex ib. Do not operate the temperature sensor in Zone 0 if the device is connected to an intrinsically safe circuit of Category Ex ib.
- When the device is connected to an intrinsically safe circuit Ex ic, the type of protection changes to Ex ic. Do not operate the temperature sensor in Zone 0 or Zone 1 if the device is connected to an intrinsically safe circuit of Category Ex ic.
- Do not interconnect the 4...20 mA/HART signal circuits of the devices of a cascade set.

Increased safety (Ex eb)

- Only use suitable certified Ex eb cable glands providing an ingress protection of at least IP65/67. The cable glands must be suitable for the intended ambient temperature range.
- Replace cable glands and sealing plugs only with identical parts.

Flameproof enclosure (Ex db)

- Connect the device:
 - Using suitable cable and wire entries of protection type "Flameproof Enclosure (Ex db)".
 - Using piping systems of protection type "Flameproof Enclosure (Ex db)".
- Seal unused entry glands with approved Ex db sealing plugs.

Safety instructions: Ex db joints

If required or if in doubt: ask manufacturer for specifications.

Potential equalization

Integrate the device into the local potential equalization.

Temperature tables

Temperature class
T6 or T5

Basic specification, Position 5 = A-D, G-T

Ambient temperature T_a (ambient)	
Without water cooling or water cooling out of operation. <ul style="list-style-type: none"> ▪ Devices with NaJ crystal scintillator: ▪ Devices with PVT plastic scintillator: 	Temperature class T6 $-40\text{ °C} \leq T_a \leq +60\text{ °C}$ $-40\text{ °C} \leq T_a \leq +60\text{ °C}$
With water cooling in operation. At the pipe housing (within the water cooling): <ul style="list-style-type: none"> ▪ Devices with NaJ crystal scintillator: ▪ Devices with PVT plastic scintillator: At the compartment housing:	Temperature class T6 or T5 $-40\text{ °C} \leq T_a \leq +60\text{ °C}$ $-40\text{ °C} \leq T_a \leq +60\text{ °C}$ $-40\text{ °C} \leq T_a \leq +75\text{ °C}$ (T6) $-40\text{ °C} \leq T_a \leq +80\text{ °C}$ (T5)

Type of protection	
Power supply circuit (Terminal compartment A)	Ex eb or Ex db
Signal circuits (Terminal compartment B)	Ex ia

Connection data

- Tightening torque of the terminal screws: max. 0.4 Nm.
- Strip the insulation of the connection wires with suitable length. Bare parts of the wires must not emerge from the terminal.
- Ensure that the wires are securely clamped.

Terminal compartment A

Increased safety (Ex eb) or Flameproof enclosure (Ex db)

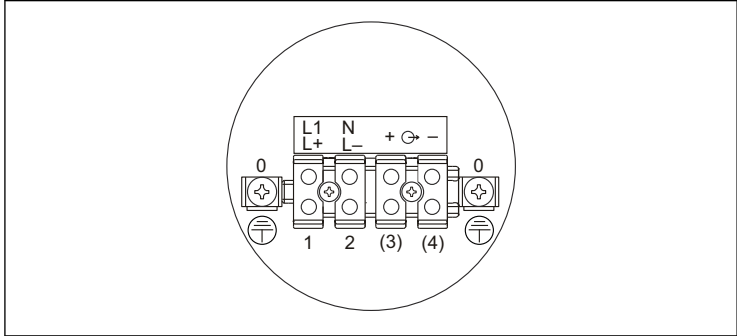

A0031763

Power supply circuit		
Basic specification, Position 2 = 1	L1 N	$U_e = 90 \text{ to } 253 \text{ V}_{AC}, 50/60 \text{ Hz}, 8.5 \text{ VA}$
Basic specification, Position 2 = 2	L+ L-	$U_e = 18 \text{ to } 35 \text{ V}_{DC}, 3.5 \text{ W}$ $U_m = 253 \text{ V}_{AC}$

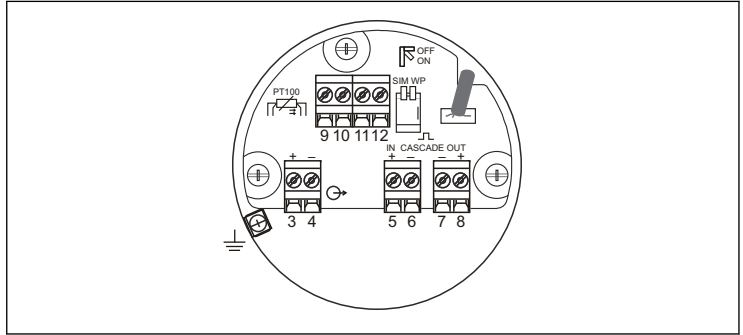

Signal circuit		
Basic specification, Position 3 = B, E	⊖ → + -	not connected
Basic specification, Position 3 = C, D	⊖ → + -	4...20 mA/HART (active) $U_m = 253 \text{ V}_{AC}$ The detector ensures galvanic isolation up to a maximum of 253 V_{AC} between the signal circuit and any other circuit.

Terminal compartment B Intrinsic safety (Ex ia)



A0031764

Signal circuit		Ex ia IIC	Ex ia IIB	Ex ib IIC	Ex ib IIB	
4...20 mA/ HART (active) ¹⁾	 + -	$U_o = 2.1.2 \text{ V}$ $I_o = 92 \text{ mA}$ $P_o = 479 \text{ mW}$ $R_i = 235 \text{ } \Omega$ $C_i = 13.4 \text{ nF}$ $L_i = 0$ Characteristic curve: linear $U_i = 30 \text{ V}$ $I_i = 13 \text{ mA}$ $P_i = 390 \text{ mW}$	$C_o = 156 \text{ nF}$ at $L_o = 0.15 \text{ mH}$ $C_o = 116 \text{ nF}$ at $L_o = 1 \text{ mH}$	$C_o = 886 \text{ nF}$ at $L_o = 0.15 \text{ mH}$ $C_o = 686 \text{ nF}$ at $L_o = 1 \text{ mH}$	$C_o = 169 \text{ nF}$ $L_o = 4 \text{ mH}$	$C_o = 1.2 \text{ } \mu\text{F}$ $L_o = 15 \text{ mH}$
PT100		$U_o = 8.4 \text{ V}$ $I_o = 8.3 \text{ mA}$ $P_o = 17.5 \text{ mW}$ $R_i = 1012 \text{ } \Omega$ $C_i = 0$ $L_i = 0$ Characteristic curve: linear	$C_o = 1200 \text{ nF}$ at $L_o = 1 \text{ mH}$ $C_o = 1800 \text{ nF}$ at $L_o = 0.15 \text{ mH}$	$C_o = 6 \text{ } \mu\text{F}$ at $L_o = 1 \text{ mH}$ $C_o = 5.2 \text{ } \mu\text{F}$ at $L_o = 2 \text{ mH}$	$C_o = 5.2 \text{ } \mu\text{F}$ $L_o = 400 \text{ mH}$	$C_o = 43 \text{ } \mu\text{F}$ $L_o = 400 \text{ mH}$
Cascade out ²⁾	 - +	$U_o = 8.4 \text{ V}$ $I_o = 19.2 \text{ mA}$ $P_o = 40.3 \text{ mW}$ $R_i = 439 \text{ } \Omega$ $C_i = 5.3 \text{ nF}$ $L_i = 67 \text{ } \mu\text{H}$ Characteristic curve: linear	$C_o = 5.1 \text{ } \mu\text{F}$ $L_o = 69 \text{ mH}$	$C_o = 42 \text{ } \mu\text{F}$ $L_o = 199 \text{ mH}$	$C_o = 5.1 \text{ } \mu\text{F}$ $L_o = 69 \text{ mH}$	$C_o = 42 \text{ } \mu\text{F}$ $L_o = 199 \text{ mH}$

Signal circuit			Ex ia IIC	Ex ia IIB	Ex ib IIC	Ex ib IIB
Cascade in ³⁾	 + -	$U_i = 8.4 \text{ V}$ $I_i = 19.2 \text{ mA}$ $P_i = 40.3 \text{ mW}$ $C_i = 0$ $L_i = 67 \text{ }\mu\text{H}$				
Connection for FHX40		$U_o = 4.7 \text{ V}$ $I_o = 37.7 \text{ mA}$ $P_o = 44.3 \text{ mW}$ $R_i = 125 \text{ }\Omega$ $C_i = 12.7 \text{ nF}$ $L_i = 0$ Characteristic curve: linear	For connection to the approved display FHX40 with associated cable (IECEX TUN 04.0011) in type of protection intrinsic safety Ex ia IIC. Observe associated Safety Instructions! $C_o = 150 \text{ }\mu\text{F}$ $L_o = 25 \text{ mH}$			

- 1) Only available at Basic specification, Position 3 = B, E
- 2) Only for connection to FMG60 signal circuit Cascade in
- 3) Only for connection to FMG60 signal circuit Cascade out



71523866

www.addresses.endress.com
