

# Installation Instructions

## **Electronic insert FEL6x**

Liquiphant FTL51B, FTL62, FTL64

# Table of contents

1	Designated use .....	3
2	Personnel authorized to carry out repairs .....	3
3	Safety instructions .....	3
4	Tools list .....	4
5	Removing the electronic insert .....	5
6	Installing the electronic insert .....	6
7	Disposal .....	7

## 1 Designated use

- A defective unit can only be replaced with a functioning unit of the same type.
- Only use original parts from Endress+Hauser.
- Check in the W@M Device Viewer if the spare part is suitable for the existing measuring device.

 A spare parts overview is located in the interior of some measuring devices. If the spare parts kit is specified on this list, no inspection is required.

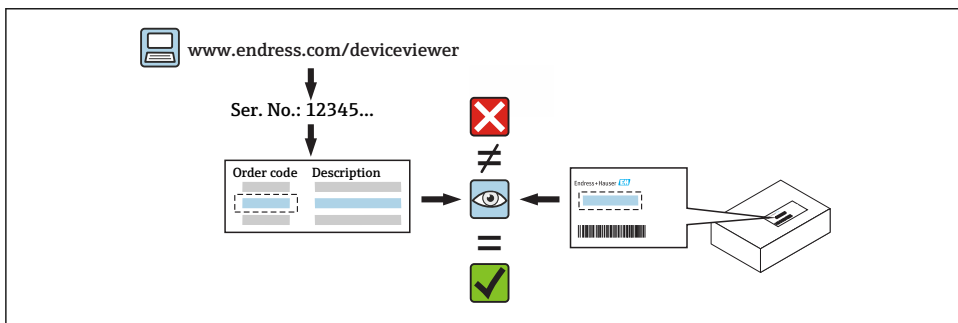

## 2 Personnel authorized to carry out repairs

Technical staff must comply with the following requirements for repair, mounting, electrical installation and commissioning of the measuring devices:

- Specialized technical staff must be trained in instrument safety.
- They must be familiar with the individual operating conditions of the devices.
- In the case of Ex-certified measuring devices, they must also be trained in explosion protection.

 Technical staff carrying out work are responsible for ensuring that the work is carried out safely and to the required quality standard. They must also guarantee the safety of the device following repair.

## 3 Safety instructions

- Comply with national regulations governing mounting, electrical installation, commissioning, maintenance and repair procedures.
- The device is energized! Risk of fatal injury from electric shock. Open the device only when the device is de-energized.
- For devices intended for use in hazardous locations, please observe the guidelines in the Ex documentation (XA).

- In the case of devices in safety-related applications in accordance with IEC 61508 or IEC 61511: Commission in accordance with Operating Instructions after repair. Document the repair procedure.
- Before removing the device: set the process to a safe state and purge the pipe of dangerous process substances.
- Hot surfaces! Risk of injury! Before commencing work: allow the system and device to cool down to a touchable temperature.
- In the case of devices in custody transfer, the custody transfer status no longer applies once the seal has been removed.
- Follow the Operating Instructions for the device.
- Risk of damaging the electronic components! Ensure you have a working environment protected from electrostatic discharge.
- After removing the electronics compartment cover: risk of electrical shock due to missing touch protection!  
Turn the device off before removing internal covers.
- Modifications to the device are not permitted.
- Only open the housing for a brief period. Avoid the penetration of foreign bodies, moisture or contaminants.
- Replace defective seals only with original seals from Endress+Hauser.
- If threads are damaged or defective, the device must be repaired.
- Do not lubricate threads (e.g. of electronics compartment cover or connection compartment cover).
- If spacing is reduced or the dielectric strength of the device is not guaranteed during repair work, perform a test on completion of the work (e.g. high-voltage test in accordance with the manufacturer's instructions).
- Service plug:
  - Do not connect in explosive atmospheres.
  - Only connect to Endress+Hauser service devices.
- Observe the instructions for transporting and returning the device outlined in the Operating Instructions.

 In case of questions, please contact the local [Endress+Hauser service organization](#).

## 4 Tools list

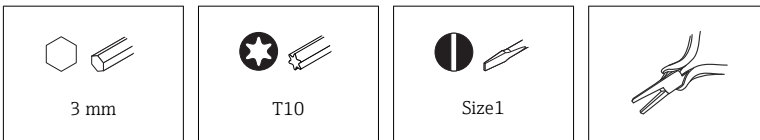

## 5 Removing the electronic insert

Cover locking, LED module and Bluetooth module: optional

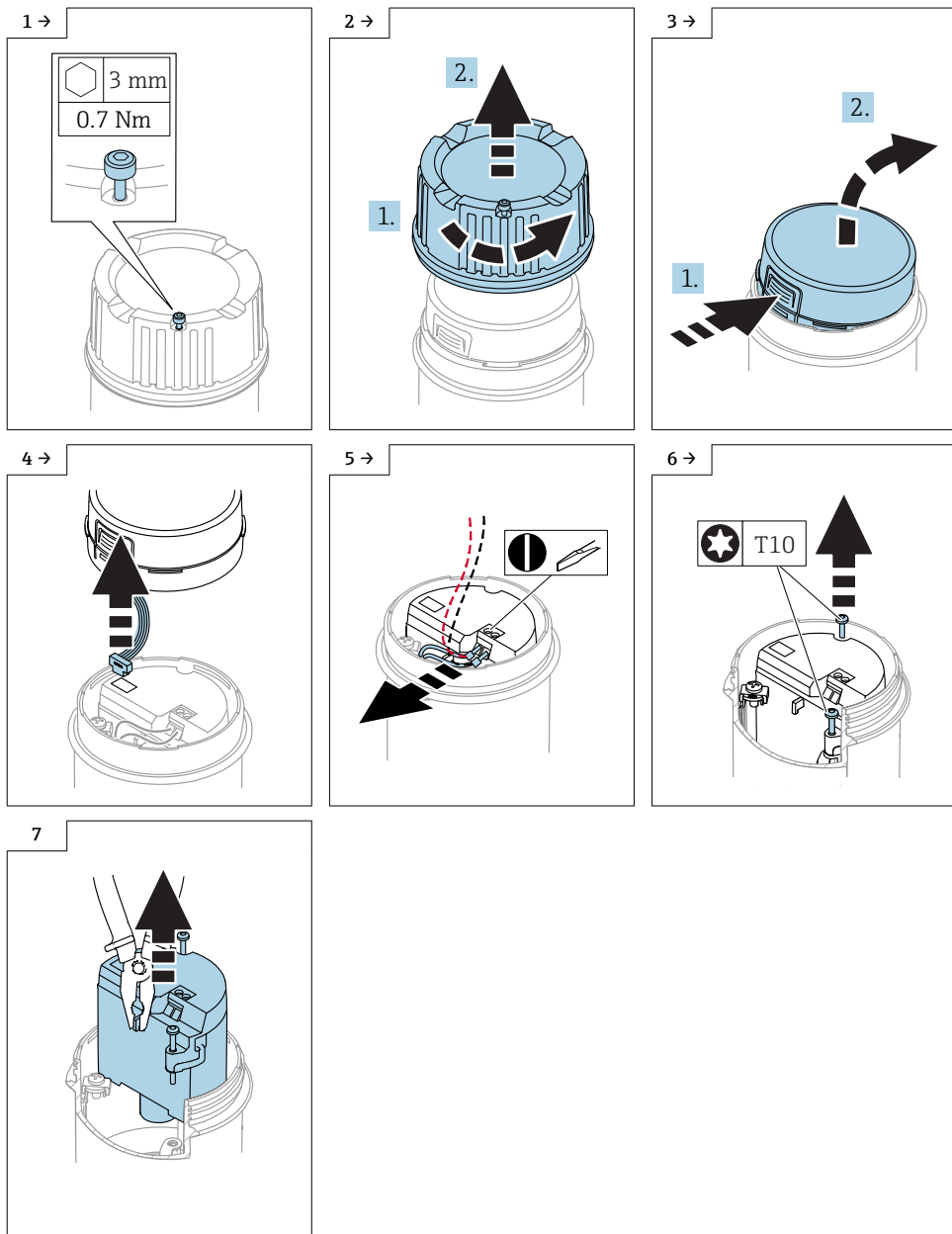

## 6 Installing the electronic insert

Installation is performed by following the removal procedure in reverse order.

 Please note the following:

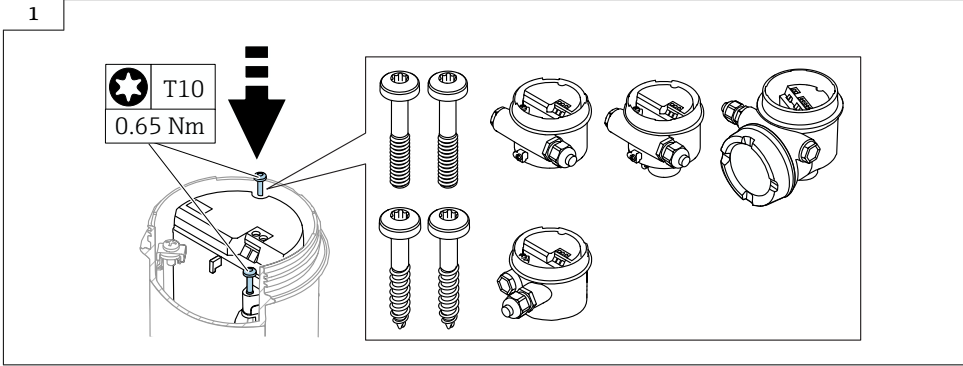

 In the case of the LED module/Bluetooth module, please also note the following:

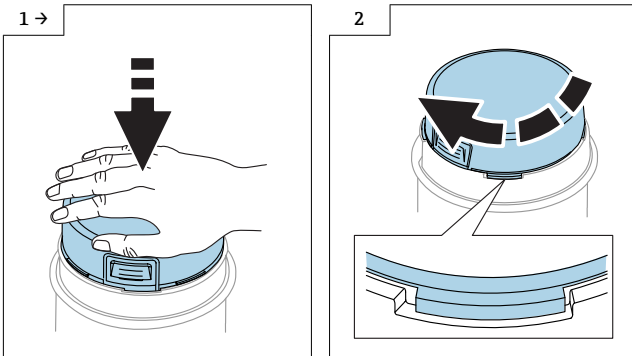

## 7 Disposal



If required by the Directive 2012/19/EU on waste electrical and electronic equipment (WEEE), our products are marked with the depicted symbol in order to minimize the disposal of WEEE as unsorted municipal waste. Such products may not be disposed of as unsorted municipal waste and can be returned to Endress+Hauser for disposal at conditions stipulated in our General Terms and Conditions or as individually agreed.



71467627

[www.addresses.endress.com](http://www.addresses.endress.com)

---