

# Safety Instructions

## **Micropilot FMR67**

4-20 mA HART

Ex ta/tb IIIC T85°C Da/Db X



Document: XA01619F-B

Safety instructions for electrical apparatus for explosion-hazardous areas →  3

Document: XA01619F-B

Temperature tables →  13

---

# Micropilot FMR67

4-20 mA HART

## Table of contents

Associated documentation . . . . .	4
Supplementary documentation . . . . .	4
Manufacturer's certificates . . . . .	4
Manufacturer address . . . . .	4
Extended order code . . . . .	4
Safety instructions: General . . . . .	7
Safety instructions: Special conditions . . . . .	7
Safety instructions: Installation . . . . .	8
Temperature tables . . . . .	8
Connection data . . . . .	9

<b>Associated documentation</b>	This document is an integral part of the following Operating Instructions: BA01620F/00 (FMR67)										
<b>Supplementary documentation</b>	Explosion-protection brochure: CP00021Z/11 The Explosion-protection brochure is available: <ul style="list-style-type: none"> <li>■ In the download area of the Endress+Hauser website: <a href="http://www.endress.com">www.endress.com</a> -&gt; Downloads -&gt; Media Type: Documentation -&gt; Documentation Type: Brochures and catalogs -&gt; Text Search: CP00021Z</li> <li>■ On the CD for devices with CD-based documentation</li> </ul>										
<b>Manufacturer's certificates</b>	<b>Certificate of Conformity TP TC 012/2011</b>  Inspection authority: LLC NANIO CCVE (ООО «НАНИО ЦСВЭ»)  Certificate number: EAЭC RU C-DE.AA87.B.00240/19  Affixing the certificate number certifies conformity with the following standards (depending on the device version): <ul style="list-style-type: none"> <li>■ GOST 31610.0-2014 (IEC 60079-0:2011)</li> <li>■ GOST 31610.11-2014 (IEC 60079-11:2011)</li> <li>■ GOST IEC 60079-31-2013</li> </ul>										
<b>Manufacturer address</b>	Endress+Hauser SE+Co. KG Hauptstraße 1 79689 Maulburg, Germany Address of the manufacturing plant: See nameplate.										
<b>Extended order code</b>	The extended order code is indicated on the nameplate, which is affixed to the device in such a way that it is clearly visible. Additional information about the nameplate is provided in the associated Operating Instructions.  <b>Structure of the extended order code</b>  <table border="0" style="margin-left: 40px;"> <tr> <td style="text-align: center;">FMR67</td> <td style="text-align: center;">–</td> <td style="text-align: center;">*****</td> <td style="text-align: center;">+</td> <td style="text-align: center;">A*B*C*D*E*F*G*..</td> </tr> <tr> <td style="text-align: center;"><i>(Device type)</i></td> <td></td> <td style="text-align: center;"><i>(Basic specifications)</i></td> <td></td> <td style="text-align: center;"><i>(Optional specifications)</i></td> </tr> </table> <p>* = Placeholder At this position, an option (number or letter) selected from the specification is displayed instead of the placeholders.</p>  <i>Basic specifications</i> The features that are absolutely essential for the device (mandatory features) are specified in the basic specifications. The number of positions depends on the number of features available. The selected option of a feature can consist of several positions.  <i>Optional specifications</i> The optional specifications describe additional features for the device (optional features). The number of positions depends on the number of features available. The features have a 2-digit structure to aid identification (e.g. JA). The first digit (ID) stands for the feature group and consists of a number or a letter (e.g. J = Test, Certificate). The second digit constitutes the value that stands for the feature within the group (e.g. A = 3.1 material (wetted parts), inspection certificate).	FMR67	–	*****	+	A*B*C*D*E*F*G*..	<i>(Device type)</i>		<i>(Basic specifications)</i>		<i>(Optional specifications)</i>
FMR67	–	*****	+	A*B*C*D*E*F*G*..							
<i>(Device type)</i>		<i>(Basic specifications)</i>		<i>(Optional specifications)</i>							

More detailed information about the device is provided in the following tables. These tables describe the individual positions and IDs in the extended order code which are relevant to hazardous locations.

**Extended order code: Micropilot**



The following specifications reproduce an extract from the product structure and are used to assign:

- This documentation to the device (using the extended order code on the nameplate).
- The device options cited in the document.

*Device type*

FMR67

*Basic specifications*

Position 1, 2 (Approval)		
Selected option		Description
FMR67	GF <sup>1)</sup>	EAC Ex ta/tb IIIC T85°C Da/Db X

- 1) The designation changes in connection with Position 4 (Display, Operation) = L, M, N:  
Ex ta/tb [ia Da] IIIC T85°C Da/Db X

Position 3 (Power Supply, Output)		
Selected option		Description
FMR67	A	2-wire, 4-20 mA HART
	B	2-wire, 4-20 mA HART, switch output (PFS)
	C	2-wire, 4-20 mA HART, 4 to 20 mA

Position 4 (Display, Operation)		
Selected option		Description
FMR67	A	Without, via communication
	C	SD02, 4-line, push buttons + data backup function
	E	SD03, 4-line, illum., touch control + data backup function
	L	Prepared for display FHX50 + M12 connection
	M	Prepared for display FHX50 + custom connection
	N	Prepared for display FHX50 + NPT1/2"

Position 5 (Housing)		
Selected option		Description
FMR67	B	GT18 dual compartment, 316L
	C	GT20 dual compartment, Alu, coated

Position 6 (Electrical Connection)		
Selected option		Description
FMR6x	A	Gland M20, IP66/68 NEMA4X/6P
	B	Thread M20, IP66/68 NEMA4X/6P
	C	Thread G1/2, IP66/68 NEMA4X/6P
	D	Thread NPT1/2, IP66/68 NEMA4X/6P

Position 7, 8 (Antenna)		
Selected option		Description
FMR67	GA	Drip-off, PTFE DN50
	GP	PTFE flush mount DN80

Position 9, 10 (Seal)		
Selected option		Description
FMR67	A3	FKM Viton GLT, -40...80°C/-40...176°F
	A5	FKM Viton GLT, -40...150°C/-40...302°F
	A6	FKM Viton GLT, -40...200°C/-40...392°F

Position 11-13 (Process Connection)		
Selected option		Description
FMR67	Axj	Flange (different sizes), 316/316L
	Cxj	Flange (different sizes), 316L
	GGj	Thread ISO228 G1-1/2, 316L
	Kxj	Flange (different sizes), 316L
	RGj	Thread ANSI MNPT1-1/2, 316L
	XxA	Align. device (different sizes)
	XxG	Flange (different sizes), PP
	Xxj	Flange (different sizes), 316L

Position 14 (Air Purge Connection)		
Selected option		Description
FMR67	A <sup>1)</sup>	W/o
	1 <sup>2)</sup>	G1/4
	2 <sup>2)</sup>	NPT1/4
	3 <sup>1)</sup>	Adapter G1/4
	4 <sup>1)</sup>	Adapter NPT1/4

1) Only in connection with Position 7, 8 (Antenna) = GA

2) Only in connection with Position 7, 8 (Antenna) = GP

*Optional specifications*

ID Nx (Accessory Mounted)		
Selected option		Description
FMR6x	NF <sup>1)</sup>	Bluetooth

1) Only in connection with Position 4 (Display, Operation) = C, E

**Safety instructions: General**

- Staff must meet the following conditions for mounting, electrical installation, commissioning and maintenance of the device:
  - Be suitably qualified for their role and the tasks they perform
  - Be trained in explosion protection
  - Be familiar with national regulations
- Install the device according to the manufacturer's instructions and national regulations.
- Do not operate the device outside the specified electrical, thermal and mechanical parameters.
- Only use the device in media to which the wetted materials have sufficient durability.
- Avoid electrostatic charging:
  - Of plastic surfaces (e.g. housing, sensor element, special varnishing, attached additional plates, ..)
  - Of isolated capacities (e.g. isolated metallic plates)
- Modifications to the device can affect the explosion protection and must be carried out by staff authorized to perform such work by Endress+Hauser.
- Refer to the temperature tables for the relationship between the permitted ambient temperature for the sensor and/or transmitter, depending on the range of application and the temperature class.

**Safety instructions: Special conditions**

Permitted ambient temperature range at the electronics housing:  
 $-40\text{ °C} \leq T_a \leq +80\text{ °C}$

- Observe the information in the temperature tables.
- In the case of process connections made of polymeric material or with polymeric coatings, avoid electrostatic charging of the plastic surfaces.
- To avoid electrostatic charging: Do not rub surfaces with a dry cloth.
- In the event of additional or alternative special varnishing on the housing or other metal parts or for adhesive plates:
  - Observe the danger of electrostatic charging and discharge.
  - Do not install in the vicinity of processes ( $\leq 0.5\text{ m}$ ) generating strong electrostatic charges.
- Avoid electrostatic charging of the sensor (e.g. do not rub dry and install outside the filling flow).

*Device type FMR67 and Basic specification, Position 11-13 (Process Connection) = XxA*

- Changing the position of the alignment device must be impossible:
  - After the alignment of the antenna via the pivot bracket
  - After tightening of the clamping flange
  - After setting the damping ring (torque 10 to 11 Nm)
- Degree of protection IP67 must be fulfilled.

*Device type FMR67 and Basic specification, Position 14 (Air Purge Connection) = 1, 2*

- If equipment with Ga/Gb or Da/Db is required: In the closed state the minimum degree of protection of the installation must be IP67.
- After removing the air purge connection: Lock the opening with a suitable plug.
  - Torque: 6-7 Nm
  - For Da/Db: thread engagement > 5 turns
- Degree of protection IP67 must be fulfilled.

## Safety instructions: Installation

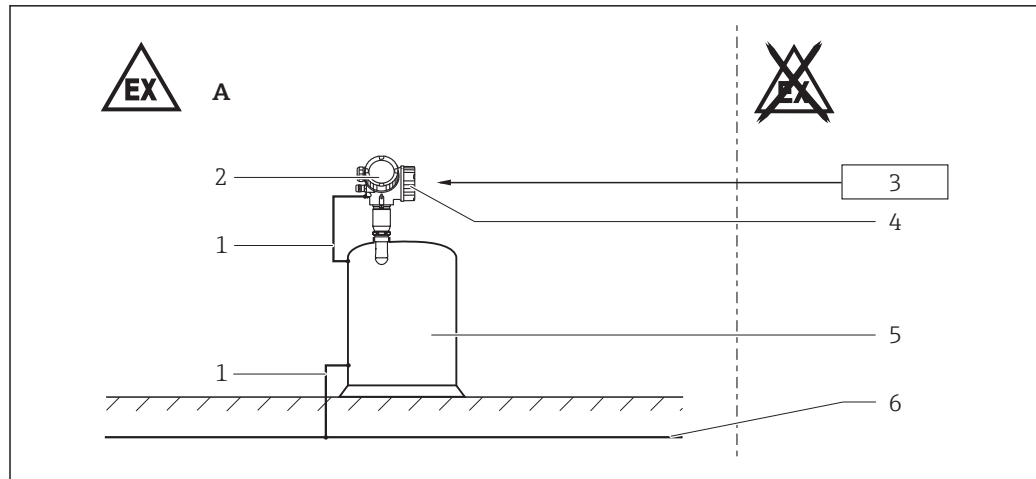

A0031947

### 1

- A Zone 20, Zone 21  
 1 Potential equalization line  
 2 Electronics compartment Ex ia; Electronic insert  
 3 Power supply  
 4 Connection compartment Ex tb  
 5 Tank; Zone 20, Zone 21  
 6 Potential equalization

- After aligning (rotating) the housing, retighten the fixing screw (see Operating Instructions).
- Install the device to exclude any mechanical damage or friction during the application. Pay particular attention to flow conditions and tank fittings.
- Only use certified cable entries or sealing plugs. The metal sealing plugs supplied meet this requirement.
- Before operation:
  - Screw in the cover all the way.
  - Tighten the securing clamp on the cover.
- After mounting and connecting the antenna, ingress protection of the housing must be at least IP65.
- Perform the following to achieve the degree of protection:
  - Screw the cover tight.
  - Mount the cable entry correctly.
- Continuous service temperature of the connecting cable:  $-40\text{ °C}$  to  $\geq +85\text{ °C}$ ; in accordance with the range of service temperature taking into account additional influences of the process conditions ( $T_{a,\min}$ ), ( $T_{a,\max} + 20\text{ K}$ ).

Basic specification, Position 4 (Display, Operation) = N

Observe the requirements according to IEC/EN 60079-14 for conduit systems and the wiring- and installation instructions of the suitable Safety Instructions (XA). In addition, observe national regulations and standards for conduit systems.

### Intrinsic safety

- The device can be connected to the Endress+Hauser FXA291 service tool: refer to the Operating Instructions.
- The device can be equipped with the Bluetooth® module: refer to the Operating Instructions and specifications in the "Bluetooth® module" chapter.

### Bluetooth® module

Optional specification, ID Nx (Accessory Mounted) = NF

- With Bluetooth® module installed: Use of external hardware not allowed (e.g. external display, service interface).
- The intrinsically safe input power circuit of the Bluetooth® module is isolated from ground.

## Temperature tables

→ 14



## Connection data

## Cable entry: Connection compartment

## Ex tb

Cable gland: *Basic specification, Position 6 (Electrical Connection) = A*

*Basic specification, Position 5 (Housing) = B, C*

*preferably for Position 5 (Housing) = B*

Thread	Clamping range	Material	Sealing insert	O-ring
M20x1,5	ø 7 to 12 mm	1.4404	NBR	EPDM (ø 17x2)

*preferably for Position 5 (Housing) = C*

Thread	Clamping range	Material	Sealing insert	O-ring
M20x1,5	ø 8 to 10.5 mm <sup>1)</sup> (ø 6.5 to 13 mm) <sup>2)</sup>	Ms, nickel-plated	LSR (Silicone)	EPDM (ø 17x2)

1) Standard

2) Separate clamping inserts available

- Only suitable for fixed installation. The operator must pay attention to a suitable strain relief of the cable.
- The cable glands are suitable for a low risk of mechanical danger (4 Joule) and must be mounted in a protected position if larger impact energy levels are expected.
- To maintain the ingress protection of the housing: Install the housing cover, cable glands and blind plugs correctly.

## Cable entry: Electronics compartment

Cable gland: *Basic specification, Position 4 (Display, Operation) = M*

*Basic specification, Position 5 (Housing) = B, C*

*preferably for Position 5 (Housing) = B*

Thread	Clamping range	Material	Sealing insert	O-ring
M16x1,5	ø 5 to 10 mm	1.4404	PA/NBR	NBR

*preferably for Position 5 (Housing) = C*

Thread	Clamping range	Material	Sealing insert	O-ring
M16x1,5	ø 5 to 10 mm	Ms, nickel-plated	PA/NBR	NBR

- Only suitable for fixed installation. The operator must pay attention to a suitable strain relief of the cable.
- The cable glands are suitable for a low risk of mechanical danger (4 Joule) and must be mounted in a protected position if larger impact energy levels are expected.
- To maintain the ingress protection of the housing: Install the housing cover, cable glands and blind plugs correctly.

**Terminals: Connection compartment**

Optional specification, ID Nx (Accessory Mounted) = NF

When using the Bluetooth® module: No changes to the connection values.

**Ex tb**

Basic specification, Position 3 (Power Supply, Output) = A

Terminal 1 (+), 2 (-)
Power supply: $U_N = 35 V_{DC}$ $U_m = 250 V$ $I_N = 4 \text{ to } 20 \text{ mA}$ $I_{max} = 22 \text{ mA}$ $P_N = 0.7 W$

Basic specification, Position 3 (Power Supply, Output) = B

The power consumption of I/O modules with passive PFS output can be limited for certain applications.

- Recommended: Power consumption = 1 W. This is obtained for a supply voltage at the terminals of 27 V<sub>DC</sub>.
- For higher supply voltages ( $U_{max}$ ): Insert a serial resistance ( $R_V$ ) in order to limit the power consumption, see table below.

**Table for the PFS serial resistance ( $R_V$ ):**

Power consumption	1.0 W
Total power consumption	1.88 W
Internal resistance $R_i$	760 $\Omega$

$U_{max}$ [V]	$R_V$ min
35	205 $\Omega$
34	177 $\Omega$
33	150 $\Omega$
32	122 $\Omega$
31	95 $\Omega$
30	67 $\Omega$
29	39 $\Omega$
28	12 $\Omega$
27	0 $\Omega$

 For values associated with a higher or lower internal power consumption please contact Endress+Hauser.

Terminal 1 (+), 2 (-)	Terminal 3 (+), 4 (-)
Power supply: $U_N = 35 V_{DC}$ $U_m = 250 V$ $I_N = 4 \text{ to } 20 \text{ mA}$ $I_{max} = 22 \text{ mA}$ $P_N = 0.7 W$	Switch output (PFS): $U_N = 35 V_{DC}$ $U_m = 250 V$ $P_N = 0.7 W$

Basic specification, Position 3 (Power Supply, Output) = C

Terminal 1 (+), 2 (-)	Terminal 3 (+), 4 (-)
Power supply: $U_N = 30 V_{DC}$ $U_m = 250 V$ $I_N = 4 \text{ to } 20 \text{ mA}$ $I_{max} = 22 \text{ mA}$ $P_N = 0.7 W$	Output 4 to 20 mA: $U_N = 30 V_{DC}$ $U_m = 250 V$ $I_N = 4 \text{ to } 20 \text{ mA}$ $I_{max} = 22 \text{ mA}$ $P_N = 0.7 W$

**Terminals: Electronics compartment**

**Ex ia**

**Service interface (CDI)**

Taking the following values into consideration, the device can be connected to the certified Endress+Hauser FXA291 service tool or a similar interface:

Service interface														
$U_i = 7.3 V$ effective inner inductance $L_i = \text{negligible}$ effective inner capacitance $C_i = \text{negligible}$														
$U_o = 7.3 V$ $I_o = 60 \text{ mA}$ $P_o = 110 \text{ mW}$														
$L_o \text{ (mH)} =$	5.00	2.00	1.00	0.50	0.20	0.15	0.10	0.05	0.02	0.01	0.005	0.002	0.001	
$C_o \text{ (}\mu\text{F)}^{1) =}$	0.73	1.20	1.60	2.00	2.60	-	3.20	4.00	5.50	7.30	10.00	12.70	12.70	
$C_o \text{ (}\mu\text{F)}^{2) =}$	-	0.49	0.90	1.40	-	2.00	-	-	-	-	-	-	-	

- 1) Values according to PTB "ispark" program
- 2) Values according to IEC/EN 60079-25, Annex C



# Micropilot FMR67

4-20 mA HART

## Table of contents

Notes on the structure .....	14
Example diagrams of possible deratings .....	16
Zone 20, Zone 21 .....	17
Zone 21 .....	19

## Notes on the structure

## Extract from the extended order code

Device type

FMR67

Basic specifications

Position 1, 2 (Approval)		
Selected option		Description
FMR67	GF <sup>1)</sup>	EAC Ex ta/tb IIIC T85°C Da/Db X

- 1) The designation changes in connection with Position 4 (Display, Operation) = L, M, N:  
Ex ta/tb [ia Da] IIIC T85°C Da/Db X

Position 5 (Housing)		
Selected option		Description
FMR67	B	GT18 dual compartment, 316L
	C	GT20 dual compartment, Alu, coated

Position 7, 8 (Antenna)		
Selected option		Description
FMR67	GA	Drip-off, PTFE DN50
	GP	PTFE flush mount DN80

 Shown in the temperature tables exemplary as follows:

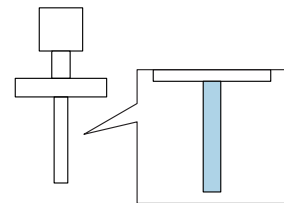

Position 9, 10 (Seal)		
Selected option		Description
FMR67	A3	FKM Viton GLT, -40...80°C/-40...176°F
	A5	FKM Viton GLT, -40...150°C/-40...302°F
	A6	FKM Viton GLT, -40...200°C/-40...392°F

 Shown in the temperature tables exemplary as follows:

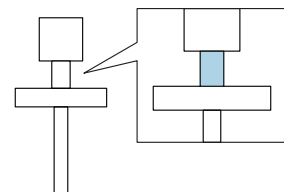

## Description notes

 Unless otherwise indicated, the positions always refer to the basic specification.

Zone 20, Zone 21

1st column: Position 5 (Housing) = A, B, ...

2nd column: Process temperature

Column P1 to P5: Position (temperature value) on the axes of the derating

- $T_a$ : Ambient temperature in °C
- $T_p$ : Process temperature in °C

 Column P2+ is only relevant for version B of the derating.

→  16

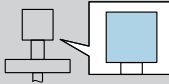
 = C		P1		P2		P2+		P3		P4		P5	
		$T_p$	$T_a$	$T_p$	$T_a$	$T_p$	$T_a$	$T_p$	$T_a$	$T_p$	$T_a$	$T_p$	$T_a$
	100	-40	75	75	75	-	-	100	58	100	-40	-40	-40
	135	-40	75	75	75	-	-	135	52	135	-40	-40	-40
	150	-40	75	75	75	-	-	150	47	150	-40	-40	-40

A0032556-EN

Zone 21

1st column: Position 5 (Housing) = A, B, ...

2nd column: Calculation of temperature values and maximum permissible ambient temperature in °C

3rd column: Maximum surface temperature in °C

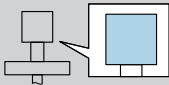
 = C		
	$T = T_a + 5 \text{ K}$	$T_a = 80$
		119

A0032555-EN

  $T_a$ : Ambient temperature in °C

Example diagrams  
of possible deratings

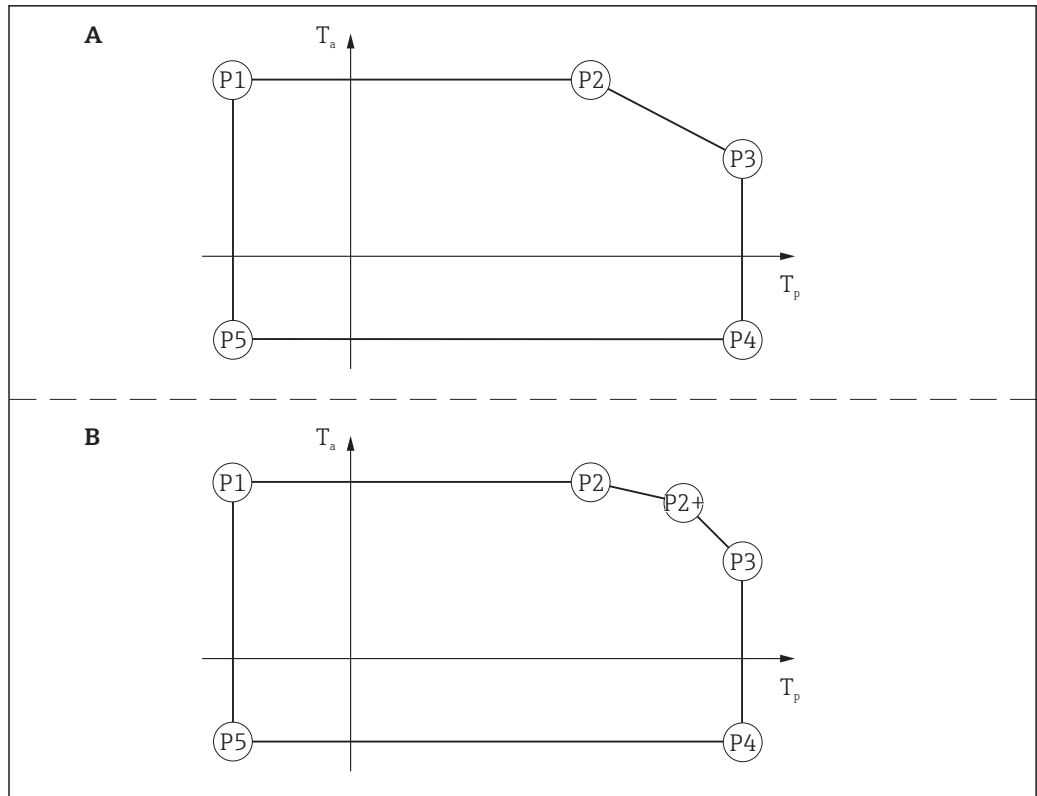

2



Zone 20, Zone 21

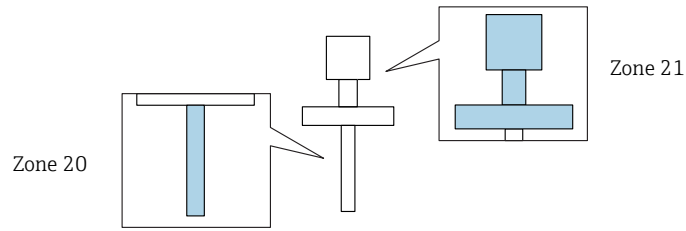

FMR67

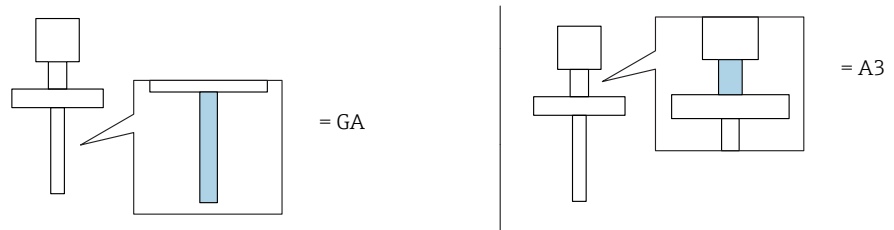

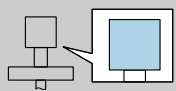
 = B, C		P1		P2		P2+		P3		P4		P5	
		T <sub>p</sub>	T <sub>a</sub>	T <sub>p</sub>	T <sub>a</sub>	T <sub>p</sub>	T <sub>a</sub>	T <sub>p</sub>	T <sub>a</sub>	T <sub>p</sub>	T <sub>a</sub>	T <sub>p</sub>	T <sub>a</sub>
	75	-40	75	75	75	-	-	75	75	75	-40	-40	-40

FMR67

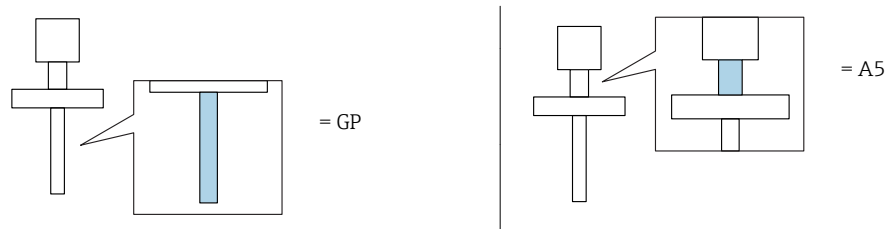

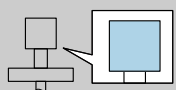
 = B		P1		P2		P2+		P3		P4		P5	
		T <sub>p</sub>	T <sub>a</sub>	T <sub>p</sub>	T <sub>a</sub>	T <sub>p</sub>	T <sub>a</sub>	T <sub>p</sub>	T <sub>a</sub>	T <sub>p</sub>	T <sub>a</sub>	T <sub>p</sub>	T <sub>a</sub>
	100	-40	75	75	75	-	-	100	58	100	-40	-40	-40
	135	-40	75	75	75	-	-	135	52	135	-40	-40	-40
	150	-40	75	75	75	-	-	150	47	150	-40	-40	-40

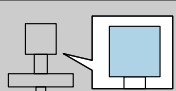
 = C		P1		P2		P2+		P3		P4		P5	
		T <sub>p</sub>	T <sub>a</sub>	T <sub>p</sub>	T <sub>a</sub>	T <sub>p</sub>	T <sub>a</sub>	T <sub>p</sub>	T <sub>a</sub>	T <sub>p</sub>	T <sub>a</sub>	T <sub>p</sub>	T <sub>a</sub>
	100	-40	75	75	75	-	-	100	60	100	-40	-40	-40
	135	-40	75	75	75	-	-	135	56	135	-40	-40	-40
	150	-40	75	75	75	-	-	150	54	150	-40	-40	-40

**FMR67**

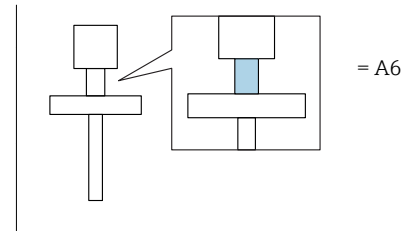
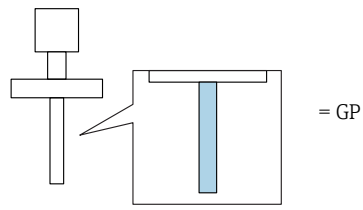

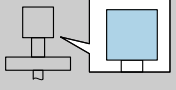
 = B, C		P1		P2		P2+		P3		P4		P5	
		T <sub>p</sub>	T <sub>a</sub>	T <sub>p</sub>	T <sub>a</sub>	T <sub>p</sub>	T <sub>a</sub>	T <sub>p</sub>	T <sub>a</sub>	T <sub>p</sub>	T <sub>a</sub>	T <sub>p</sub>	T <sub>a</sub>
	100	-40	75	75	75	-	-	100	61	100	-40	-40	-40
	135	-40	75	75	75	-	-	135	58	135	-40	-40	-40
	200	-40	75	75	75	-	-	200	53	200	-40	-40	-40

Zone 21

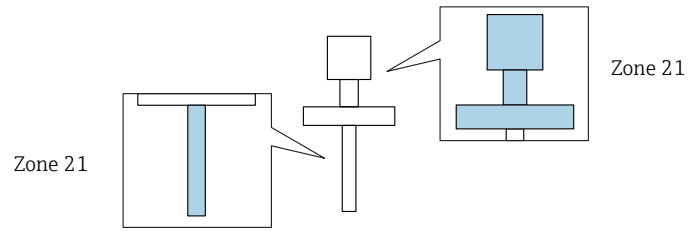

FMR67

	$T = T_a + 10 K$	$T_a = 75$
		85



71458762

[www.addresses.endress.com](http://www.addresses.endress.com)

---