



Special Documentation

Mounting hints for weld-in adapter

Level and pressure measurement

TI00426F

QR-Code

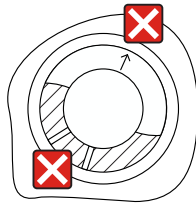
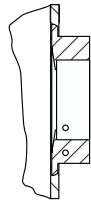
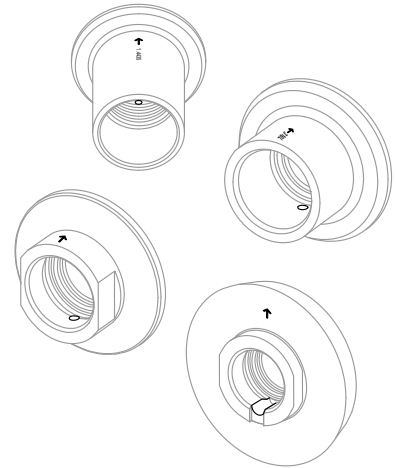
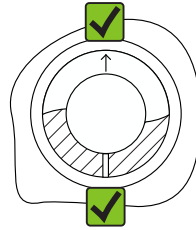
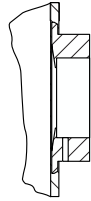

1.

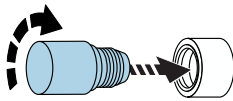

2.

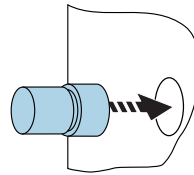

3.

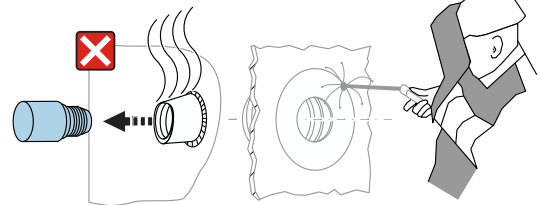
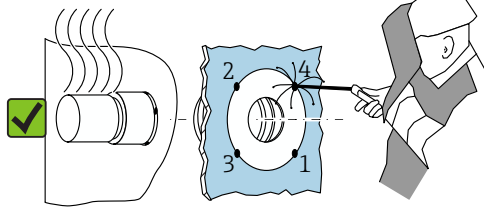

4.

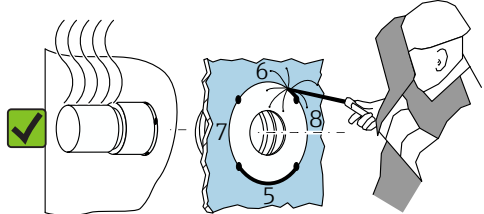

5.

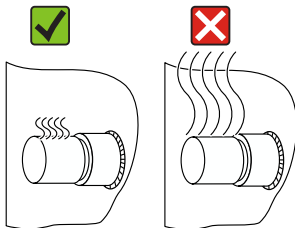

6.

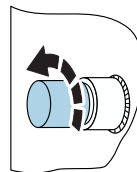

7.

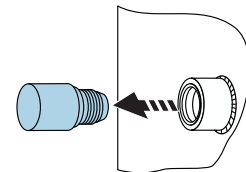

A0036469

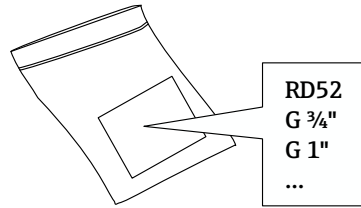
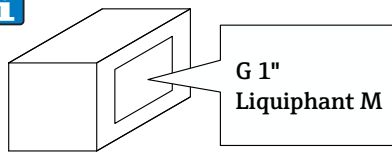

G 1" Liquiphant M

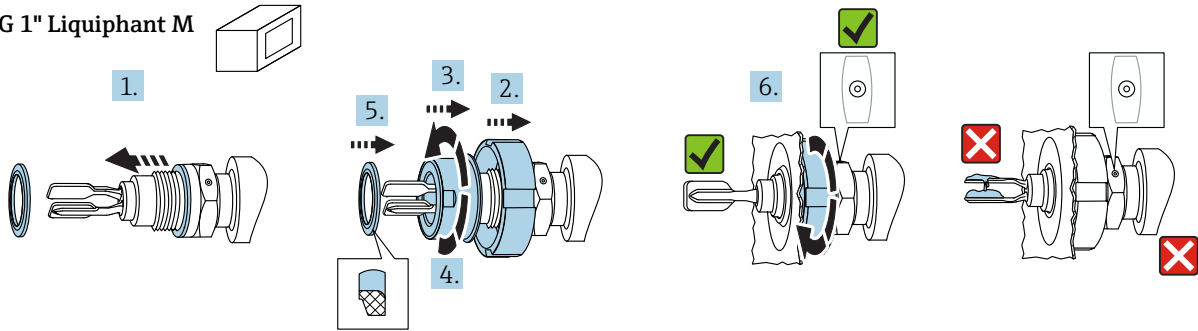

RD52

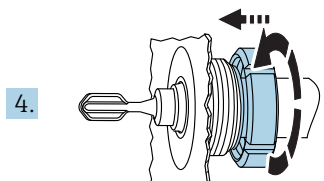
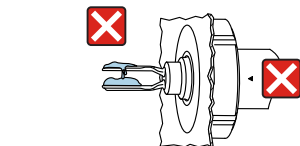
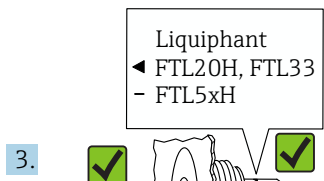
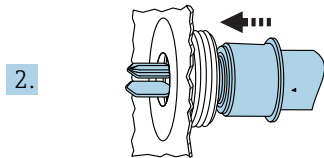
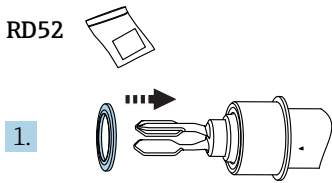

G 3/4" d55
G 1" d53
G 1" d60
G 3/4" d50
G 3/4" d29

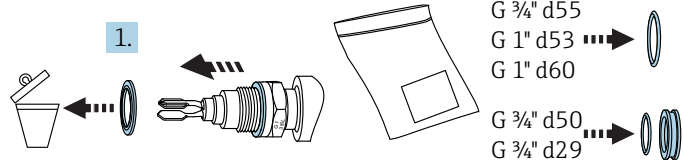

G 3/4" d55
G 1" d53
G 1" d60

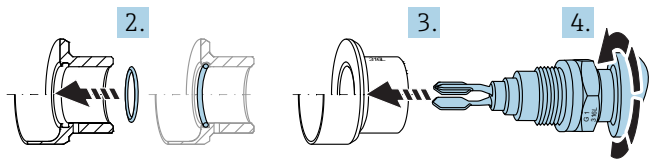

G 3/4" d50
G 3/4" d29

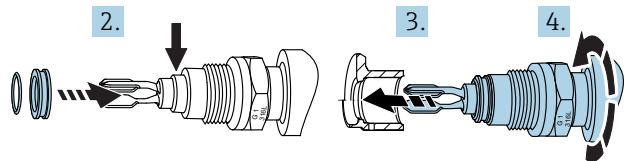

5.

