

Brief Operating Instructions **Overfill Prevention System SOP300**

For reliable and secure tank overfill prevention



Table of contents





1	About this document	2
1.1	Symbols used	3
1.2	Text emphasis	4
1.3	Acronyms used	4
1.4	Valid versions	5
1.5	Registered trademarks	5
2	Basic safety instructions	5
2.1	Requirements for personnel	5
2.2	Designated use	5
2.3	Occupational safety	6
2.4	Operational safety	6
2.5	Product safety	6
2.6	IT security	6
3	Product description	7
3.1	Product design	7
4	Incoming acceptance and product identification	13
4.1	Incoming acceptance	13
4.2	Product identification	13
4.3	Storage and transport	14
5	Installation	14
5.1	Installation conditions	14
5.2	Mounting the control cabinet	15
5.3	Mounting the field signalization system	18
5.4	Post-installation check	18
6	Electrical connection	19
6.1	Connection conditions	19
6.2	Connecting the system	20
6.3	Ensuring the degree of protection	25
6.4	Post-connection check	26
7	Operation options	26
8	Commissioning	27
8.1	Function check	27
8.2	Switching on the Overfill Prevention System	27
8.3	Configuring the Overfill Prevention System	28
8.4	Configuring sensors	28
8.5	Performing the functional test	28

1 About this document











These Brief Operating Instructions describe the commissioning of Overfill Prevention System SOP300 in conjunction with the listed documents.

1.1 Symbols used







1.1.1 Safety symbols

Symbol	Meaning
	DANGER! This symbol alerts you to a dangerous situation. Failure to avoid this situation will result in serious or fatal injury.
	WARNING! This symbol alerts you to a dangerous situation. Failure to avoid this situation can result in serious or fatal injury.
	CAUTION! This symbol alerts you to a dangerous situation. Failure to avoid this situation can result in minor or medium injury.
	NOTE! This symbol contains information on procedures and other facts which do not result in personal injury.

1.1.2 Symbols for certain types of information

Symbol	Meaning	Symbol	Meaning
	Permitted Procedures, processes or actions that are permitted.		Preferred Procedures, processes or actions that are preferred.
	Forbidden Procedures, processes or actions that are forbidden.		Tip Indicates additional information.
	Reference to documentation		Reference to page
	Reference to graphic		Series of steps
	Result of a step		Visual inspection

1.1.3 Electrical symbols

Symbol	Meaning	Symbol	Meaning
	Direct current		Alternating current
	Direct current and alternating current		Ground connection A grounded terminal which, as far as the operator is concerned, is grounded via a grounding system.
	Protective ground connection A terminal which must be connected to ground prior to establishing any other connections.		Equipotential connection A connection that has to be connected to the plant grounding system: This may be a potential equalization line or a star grounding system depending on national or company codes of practice.

1.2 Text emphasis

Emphasis	Meaning	Example
Bold	Keys, buttons, program icons, tabs, menus, commands	Start → Programs → Endress+Hauser In the File menu, select the Print option.
Angle brackets	Variables	<DVD drive>

1.3 Acronyms used

Acronyms	Meaning
AC	Alternating Current
AOPS	Automated Overfill Prevention System
CPU	Central Processing Unit
DC	Direct Current
DHCP	Dynamic Host Configuration Protocol
H	High-Limit (upper warning limit)
HH	HighHigh Limit (upper alarm limit)
HMI	Human Machine Interface (e.g. operating panel)
L	Low-Limit (lower warning limit)
LL	LowLow-Limit (lower alarm limit)
NC	Normally Closed
OPS	Overfill Prevention System
MOPS	Manual Overfill Prevention System
PLC	Programmable logic controller (PLC)

Acronyms	Meaning
UPS	Uninterruptible power supply
VNC	Virtual Network Computing (software for the transmission of the screen content)
WAN	Wide Area Network (possible communication channel for remote maintenance modem)
3G	Wireless data transmission standard (possible communication channel for remote maintenance modem)
I/O (E/A)	Inputs/Outputs

1.4 Valid versions

Component	Version
Software	V1.00.xx
Hardware platform	V1.00.xx

1.5 Registered trademarks

All brand and product names are trademarks or registered trademarks of the respective companies and organizations.

2 Basic safety instructions

2.1 Requirements for personnel

Personnel must meet the following requirements to perform its tasks:

- ▶ Trained, qualified specialists: must have a relevant qualification for this specific role and task and have been trained by Endress+Hauser. Experts at the Endress+Hauser service organization.
- ▶ Personnel must be authorized by the plant owner/operator.
- ▶ Personnel must be familiar with regional and national regulations.
- ▶ Before starting work: personnel must read and understand the instructions in the manual and supplementary documentation as well as the certificates (depending on the application).
- ▶ Personnel must follow instructions and comply with general policies.

2.2 Designated use

The Overfill Prevention System has been designed as a safety function for the monitoring of critical levels (HH, H, L, LL) in tanks. It is also possible to monitor leaks in tanks and tank pipes in the tank basin. Appropriate sensors must be used for monitoring.



For more information on "sensors", see the Technical Information

Any other use is considered to be non-designated use. Designated use entails compliance with the operating and maintenance requirements specified by the manufacturer. The Overfill Prevention System must be installed in a safe environment (not in hazardous areas or Ex zones). We recommend that you install the Overfill Prevention System in a dry, air-conditioned room.



Dangers

It is the responsibility of the owner/operator to assess any dangers for the systems. These dangers must be assessed by the owner/operator and the measures resulting from the assessment must be implemented. While the Overfill Prevention System can form part of such a measure, responsibility for the entire safety function always rests with the owner/operator, particularly the taking of suitable measures if the Overfill Prevention System signals an alarm. We also specifically state that relevant measures must also be assessed from a process engineering perspective.



Incorrect use

Non-designated use can compromise safety. The manufacturer is not liable for damage caused by improper or non-designated use.

2.3 Occupational safety

Personnel must meet the following conditions when working on and with the system:

- ▶ Wear the required personal protective equipment according to regional/national regulations.
- ▶ When welding, do not ground the welding unit via the system.
- ▶ If hands are wet, wear gloves on account of the higher risk of electric shock.

2.4 Operational safety

Operate the system only if it is in proper technical condition, free from errors and faults.

The operator is responsible for the interference-free operation of the system.

2.5 Product safety

This device is designed in accordance with industry practice to meet state-of-the-art safety requirements, has been tested, and left the factory in a condition in which it is safe to operate. It meets general safety standards and legal requirements. It also complies with the EC directives listed in the product-specific EC Declaration of Conformity. Endress+Hauser confirms this by affixing the CE mark to the device.

2.6 IT security

We only provide a warranty if the system is installed and used as described in the Operating Instructions. The system is equipped with security mechanisms to protect it against any inadvertent changes to the device settings.

IT security measures in line with operators' security standards and designed to provide additional protection for the system and system data transfer must be implemented by the operators themselves.



The operator is responsible for data backup.

3 Product description

3.1 Product design

This solution package offers a reliable solution to monitor the level of fluids in tanks (H and HH as overfill prevention, L and LL to prevent the system from running dry) and to detect leaks in the tank basin. This product is primarily designed for the oil, gas chemical, primaries and metal industries but can also be used in other sectors. The system measures the level using sensors and transmitters and, in the event of an alarm, switches safety relays or activates the relevant alarm signalization devices in the field. Thanks to the flexible system configuration, a wide range of tank configurations can be monitored in a single system. A maximum of five different states can be detected per tank (HH, H, L, LL and leaks). A safety relay can be assigned to each of these alarm and warning states, and responses that correspond to these states can be initiated automatically. Similarly, in the event of an alarm condition in the system overall, a collective relay can be switched or corresponding field signalization can be enabled. Depending on the configuration, the system can be used as either an automatic tank monitoring system (a floating changeover switch switches in the event of an alarm/warning) or as a manual tank monitoring system (strobe and/or siren is activated in the event of an alarm).



The actuator connected to the floating contacts is not part of this product. They are plant-specific and are therefore the responsibility of the plant owner/operator.

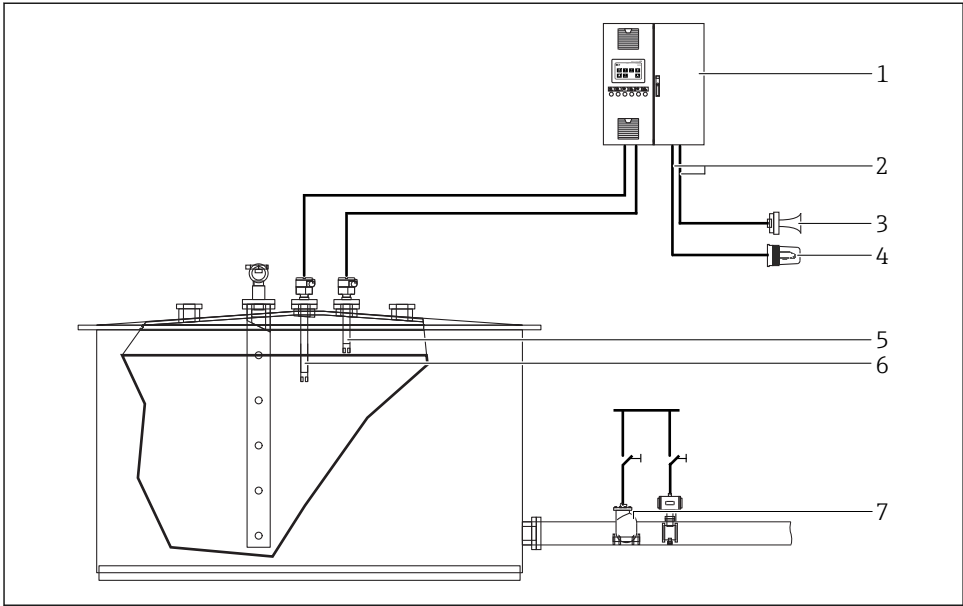

1 Overview of Manual Overfill Prevention System (MOPS), example

- 1 Control cabinet for Overfill Prevention System
- 2 Safety relay output
- 3 Field signaling siren
- 4 Field signaling strobe
- 5 Sensor for High-High alarm
- 6 Sensor for High warning
- 7 Actuator to be disabled manually

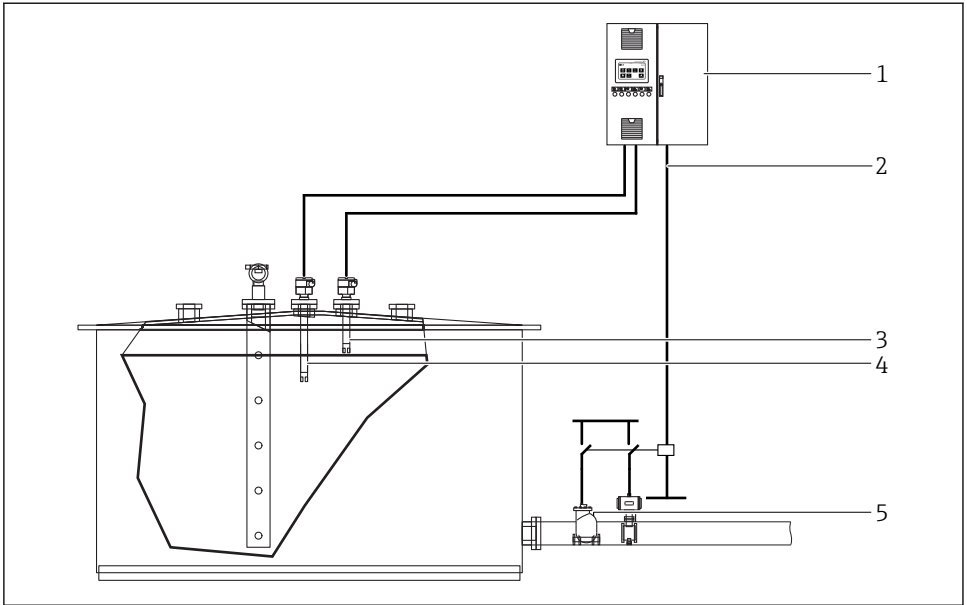

2 Overview of Automated Overfill Prevention System (AOPS), example

- 1 Control cabinet for Overfill Prevention System
- 2 Safety relay output
- 3 Sensor for High-High alarm
- 4 Sensor for High warning
- 5 Automatically disabled actuator

3.1.1 System overview

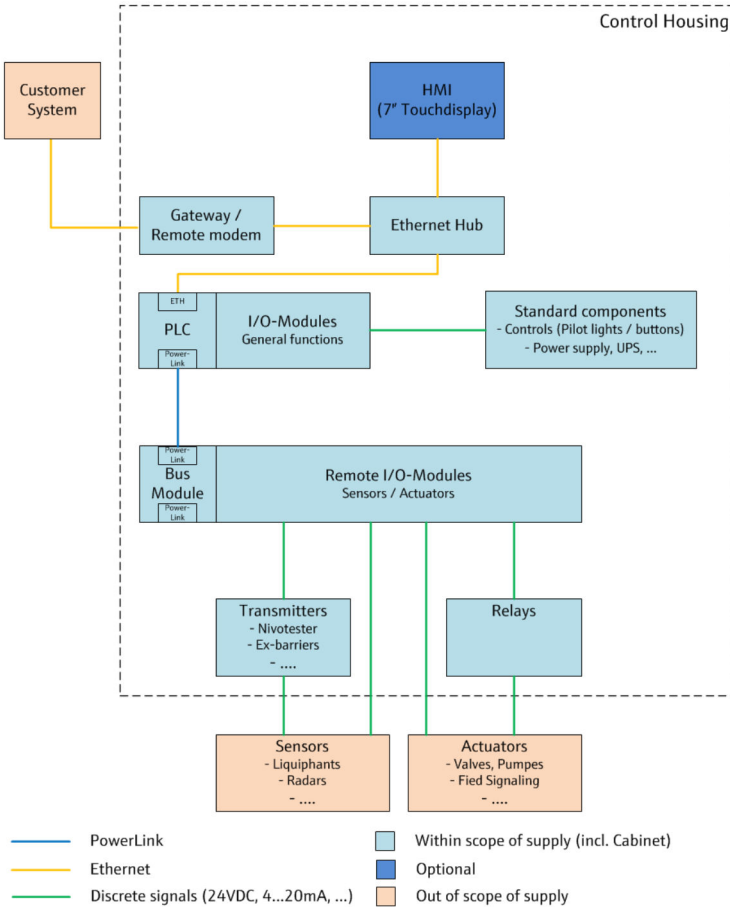

3 System overview with integrated operating elements (standard)

The operating panel is optionally available to order as a separate housing (380 mm x 380 mm x 210 mm). A maximum distance of 100 m is possible between the control cabinet and operating panel.

The following elements are installed in the separate housing:

- 7" touch display as the HMI (optional)
- Built-in door elements

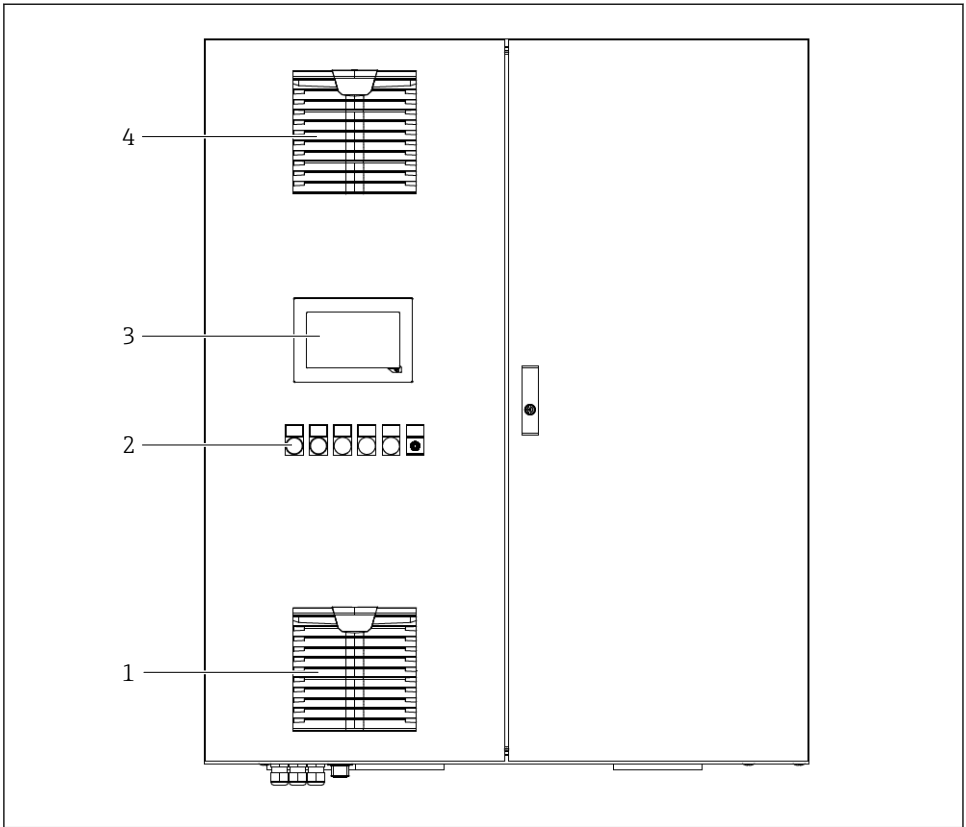

4 Example of control cabinet, exterior view (wall cabinet 1000 mm x 1200 mm x 300 mm)

- 1 Filter fan
- 2 Built-in door elements
- 3 7" touch display (optional)
- 4 Air filter

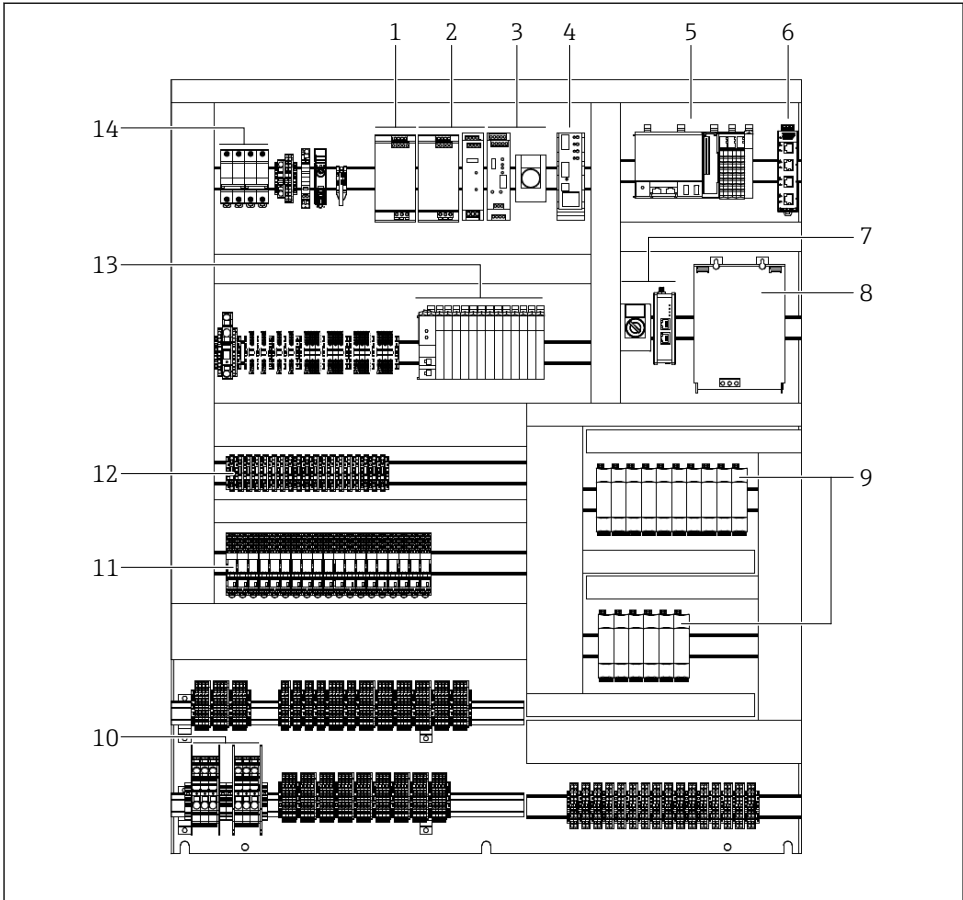

5 Example of control cabinet, interior view (wall cabinet 1000 mm x 1200 mm x 300 mm)

- 1 Power supply
- 2 Redundant power supply including redundancy module (optional)
- 3 Optional UPS including button to deactivate battery if no supply voltage is present
- 4 Electronic fuse
- 5 Controller
- 6 Network switch
- 7 Remote modem / gateway (SiteManager)
- 8 Battery for optional UPS
- 9 Nivotester
- 10 Power terminals for mains connection
- 11 Safety relay

- 12 *Fuse terminals*
- 13 *Remote I/Os*
- 14 *Power supply circuit-breakers*



The arrangement varies depending on the configuration.

4 Incoming acceptance and product identification

4.1 Incoming acceptance

- Check the packaging for visible damage arising from transportation.
- To avoid damage, remove the packaging with care.
- Retain all the accompanying documents.

The system may not be put into operation if the contents are found to be damaged beforehand. Contact your Endress+Hauser Sales Center if this happens. Return the device to Endress+Hauser in the original packaging where possible.





4.2 Product identification

The system can be identified by the nameplate, which is fitted on every cabinet.

4.2.1 Endress+Hauser products

You can identify the components in the following ways:

- Enter the serial number indicated on the nameplate in W@M Device Viewer (www.endress.com → About us → W@M Life Cycle Management → Operations → The right device information always at hand (find spare part) → Access device-specific information → Enter serial number): all the information relating to the system/device is then displayed.
- Enter the serial number indicated on the nameplate into the Endress+Hauser Operations App, or scan the 2-D matrix code (QR code) on the nameplate using the Endress+Hauser Operations App: all the information relating to the measuring device is then displayed.

Endress+Hauser Process Solutions AG CH-4153 Reinach	Endress+Hauser 
Overfill Prevention System	
Order code:	SOP300-12P7/0
Serial number:	M9000424450
Ext. order code:	SOP300-1AA1A+#
Power (nom.):	100...240 V AC 45...65 Hz, 264 VA
SW:	01.00.00 <input type="text"/>
HW:	01.00.00
Ta:	+5...+30 °C
 → 	
	
Made in Switzerland	Year of manufacturing: 2017

4.3 Storage and transport

- The cabinet is packed in such a way that it is fully protected against shock when in storage and during transportation. The original packaging offers the best protection.
- The permitted storage temperature is 0 to 40 °C (32 to 104 °F).
- When transporting the cabinet protect it from direct sunshine to avoid excessively high surface temperatures
- Store the cabinet packaged in a dry place
- Transport the cabinet to its final destination in the transportation box in which it was delivered

5 Installation

5.1 Installation conditions



Non-designated installation: control cabinet and/or field signalization system are installed in a hazardous area!

If the device is not installed as designated, this can cause an explosion.

- ▶ Install the control cabinet and field signalization system in non-hazardous areas only.



Noise from alarm siren (105 dB up to one meter)!

The alarm siren can cause temporary hearing impairment and stress.

- ▶ Only install alarm siren outdoors.

⚠ CAUTION**Leaking battery fluid!**

Leaking battery fluid can cause skin lesions and poisoning.

- ▶ Avoid contact with leaking battery fluid.
- ▶ Do not inhale battery fluid vapors.
- ▶ Replace faulty batteries immediately.

5.1.1 Control cabinet

The following conditions must be met:

- Dry and air-conditioned indoor area
- Non-hazardous area
- Ambient temperature: 5 to 30 °C
- Humidity: maximum 85 %

5.1.2 Field signalization (cables and components)

The following conditions must be met:

- Non-hazardous area
- Ambient temperature: -25 to 55 °C
- Humidity: maximum 90%
- The strobe light and alarm siren must be protected from direct sunlight

5.2 Mounting the control cabinet**⚠ CAUTION****Loose wires!**

Loose wires can cause people to trip, slip or fall.

- ▶ Always lay cables into and out of the control cabinet correctly, e.g. in cable ducts.

The cable entries are located on the bottom of all control cabinets.

5.2.1 Control cabinet for wall mounting**⚠ WARNING****The control cabinet can fall down if it is not installed correctly!**

Danger of crushing!

- ▶ Mount the control cabinet on a stable wall using all the cabinet holders.
- ▶ The wall must be designed to hold the weight of the cabinet.
- ▶ The securing screws must be designed to hold the weight of the cabinet.
- ▶ Ensure that all the securing screws are securely tightened.
- ▶ Observe the mounting instructions and technical aids.

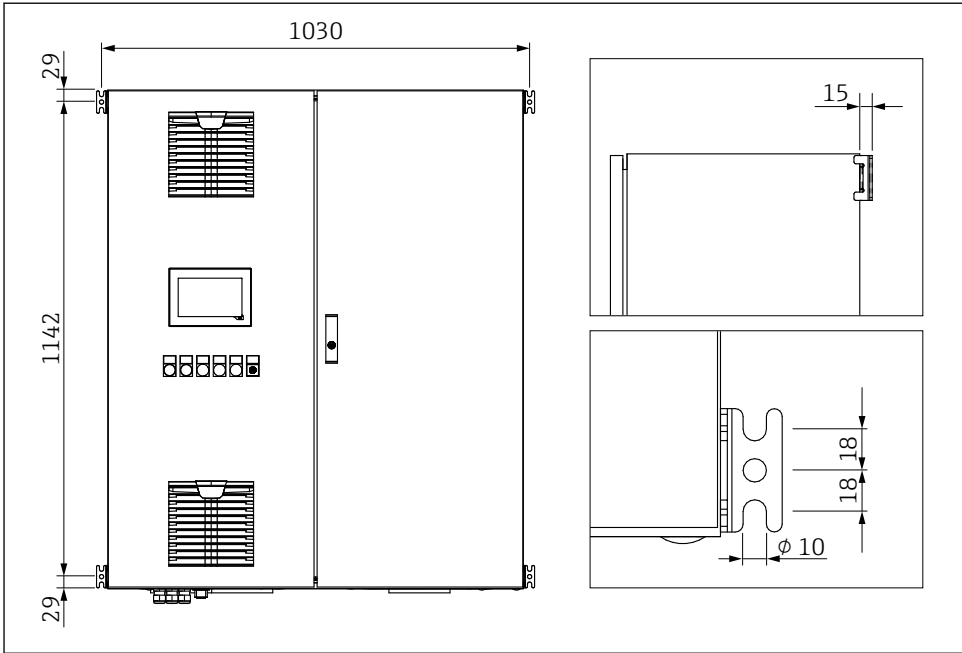

6 Example: control cabinet for wall mounting

Cabinets for wall mounting are supplied with holders.

- ▶ Mount the control cabinet on a stable wall using the cabinet holders.

5.2.2 Cabinet for free-standing installation

⚠ WARNING

The control cabinet can topple over if it is not installed correctly!

Danger of crushing!

- ▶ Screw the control cabinet to the floor.
- ▶ The floor must be even.
- ▶ The floor must be designed to hold the weight of the cabinet.
- ▶ The securing screws must be designed for the cabinet.
- ▶ Observe the mounting instructions and technical aids.

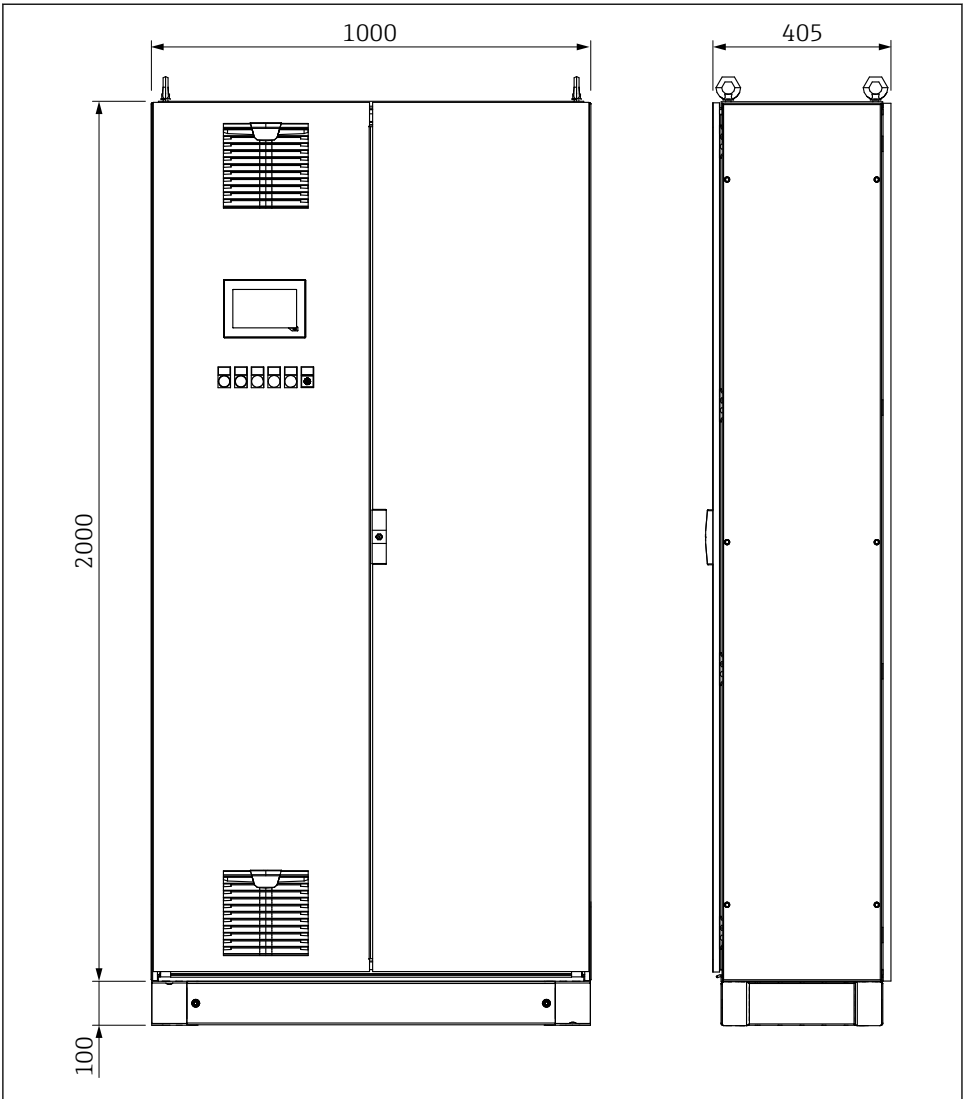

7 Example: free-standing cabinet

Free-standing cabinets are supplied with a 100 mm base.

- ▶ Screw the control cabinet onto a secure and even floor.

5.3 Mounting the field signalization system

The strobe light and siren must be mounted on a stable and even apparatus using the dimensioned drawings provided below. If possible, the devices should be mounted with the cable glands pointing downwards.

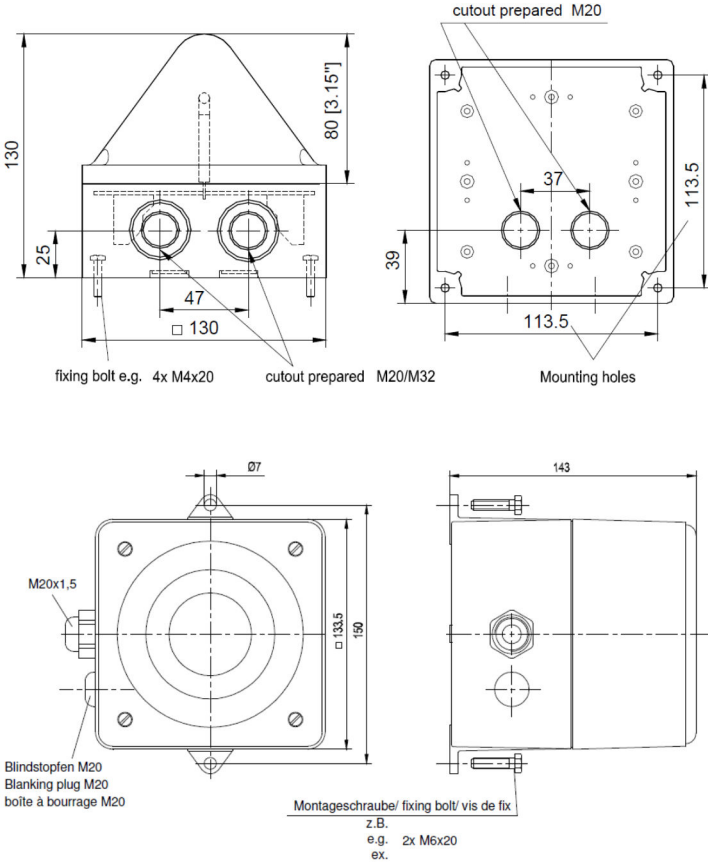

5.4 Post-installation check

Are the mounted components undamaged (visual inspection)?	<input type="checkbox"/>
Do all the components meet the required specifications? For example: <ul style="list-style-type: none"> ■ Ambient temperature ■ Humidity ■ Explosion protection 	<input type="checkbox"/>
Is the correct orientation selected?	<input type="checkbox"/>
Are the measuring point identification and labeling correct (visual inspection)?	<input type="checkbox"/>

Is the device adequately protected from precipitation and direct sunlight?	<input type="checkbox"/>
Are the securing screws tightened securely?	<input type="checkbox"/>

6 Electrical connection

6.1 Connection conditions

DANGER

Electrical voltage!

Severe or life-threatening injuries!

- ▶ Electrical work may only be performed by electrical technicians.
- ▶ The electrical connection must be performed when the device is de-energized. Make sure the device is de-energized.
- ▶ Connect the protective ground.

DANGER

Risk of electric shock from faulty cables and components!

Faulty cables and components can cause an electric shock and life-threatening injuries.

- ▶ Check cables and components regularly.
- ▶ Avoid moisture on the cabinet interior.

CAUTION

Leaking battery fluid!

Leaking battery fluid can cause skin lesions and poisoning.

- ▶ Avoid contact with leaking battery fluid.
- ▶ Do not inhale battery fluid vapors.
- ▶ Replace faulty batteries immediately.

NOTICE

Unsuitable cable types!

High temperatures can put a strain on cables.

- ▶ Use cables that suit the temperature range. The cables must be suitable for temperatures of 5 °C (9 °F) above the ambient temperature.

NOTICE

Electrical overloading, incorrect supply voltage and incorrect wiring!

Possible malfunction or destruction of the system.

- ▶ Before commissioning the device, check that the supply voltage matches the information on the nameplate.
- ▶ Install an overload protection element for the power cable. Observe the nominal current in accordance with the wiring diagram.
- ▶ Establish the connection as per the wiring diagram.

6.2 Connecting the system

6.2.1 Supply voltage electrical connection

The supply voltage must meet the following requirements:

- L / N / PE
- 100 to 240 V AC
- 45 to 65 Hz
- Wire cross-section: min. 2.5 mm², observe country-specific standards

If the control cabinet of the Overfill Prevention System is fitted with an optional, redundant power supply, the supply voltage can be redundant. If a redundant supply voltage is not available, you can bridge the existing supply voltage in the control cabinet. Refer to the separate wiring diagram.

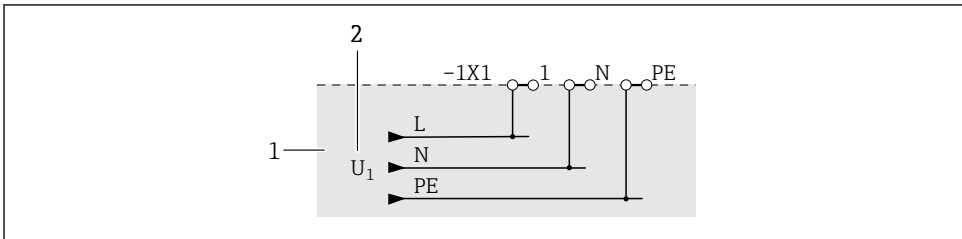

8 Supply voltage connection without a redundant power supply in the control cabinet SOP300

- 1 Customer side
2 Supply voltage U_1

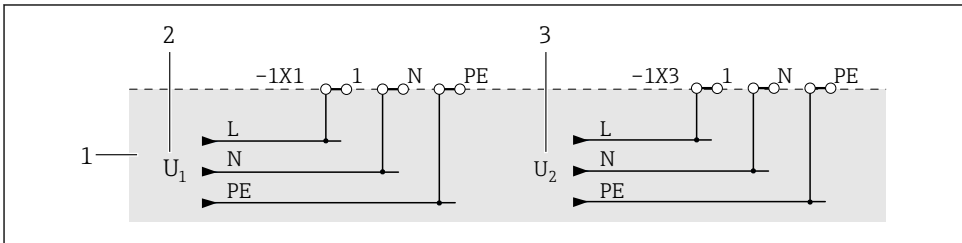

9 Supply voltage connection with a redundant power supply in the control cabinet SOP300 – with a redundant supply voltage

- 1 Customer side
2 Supply voltage U_1
3 Supply voltage U_2

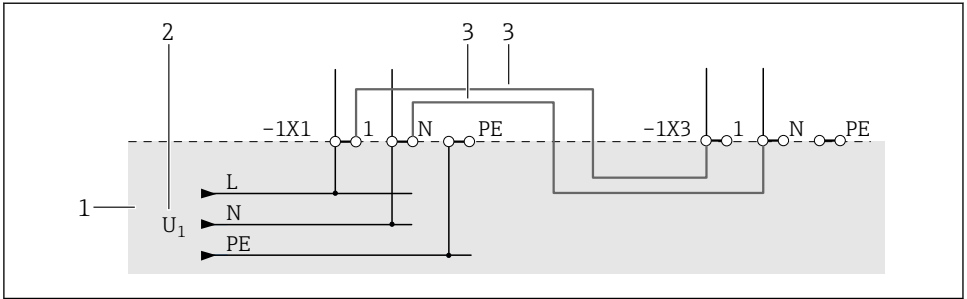

10 Supply voltage connection with a redundant power supply in the control cabinet SOP300 – without a redundant supply voltage

- 1 Customer side
- 2 Supply voltage U_1
- 3 Bridge at least 2.5 mm², provided by the customer onsite

6.2.2 Electrical connection of the input signals

Input signal: Nivotester FTL325P-#1E1

Connectable point level switches:

- Liquiphant M FTL50 (H), FTL51 (H) and FTL51C with FEL57 electronic insert
- Liquiphant S FTL70 and FTL71 with FEL57 electronic insert

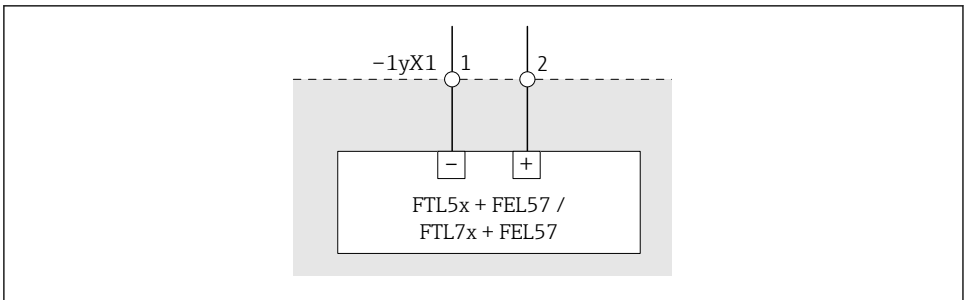

11 Connection example Liquiphant FTL5x / FTL7x with FEL57 electronic insert

y 1 = HH, 2 = H, 3 = L, 4 = LL

Input signal: point level switch

Connectable point level switches:

Every sensor that activates a floating contact (NEx/Ex(d)) if a point level is exceeded or undershot

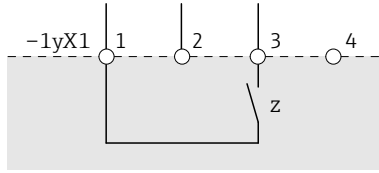

▣ 12 Connection example for point level switches

y 1 = HH, 2 = H, 3 = L, 4 = LL, 5 = Leak

z NC or NO contact, depending on the sensor

1 24 V DC

2 0 V DC

3 Point level "OK" or "Not OK" with 24 V DC signal, depends on sensor, point level "OK" is recommended as a wire break is reliably detected and the relay adopts a safe state

4 NA

Input signal: point level switch with device error

Connectable point level switches:

Every sensor that has two floating contacts (NEx/Ex(d)). One contact is used for point level detection and the second contact for the device error.

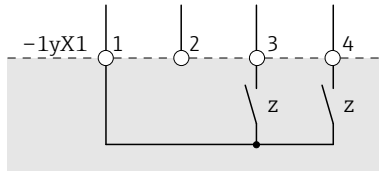

▣ 13 Connection example of point level switch with device error

y 1 = HH, 2 = H, 3 = L, 4 = LL, 5 = Leak

z NC or NO contact, depending on the sensor

1 24 V DC

2 0 V DC

3 Point level "OK" or "Not OK" with 24 V DC signal, depends on sensor, point level "OK" is recommended as a wire break is reliably detected and the relay adopts a safe state

4 "Device error" or "No device error" with 24 V DC signal, depends on sensor, "No device error" is recommended as a wire break is reliably detected and the relay adopts a safe state

Input signal: continuous level

The sensor must meet the following requirements:

- Output signal: 4 to 20 mA for 0 % to 100 % level
- NEx/Ex(d)
- 2-wire sensors (passive) or 4-wire sensors (active)

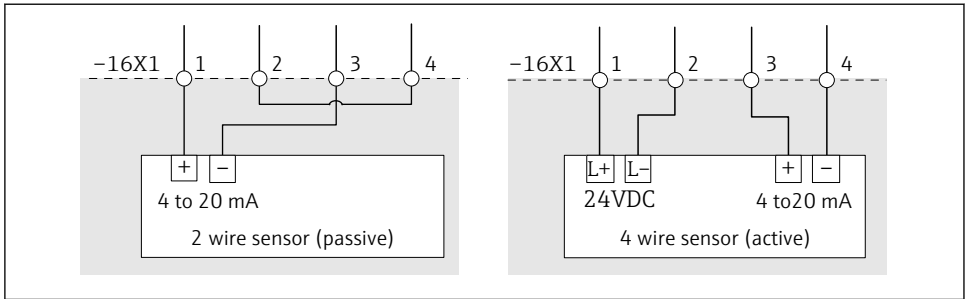

14 Left: connection example for 2-wire sensor with 4 to 20 mA signal, right: connection example for 4-wire sensor with 4 to 20 mA signal

- 1 24 VDC
- 2 0 VDC
- 3 4 to 20 mA signal (+)
- 4 4 to 20 mA signal (-)

6.2.3 Electrical connection of the output signals

Output signal: alarm relay (changeover contact)

Function relay

Actuators can be connected via the floating changeover contact. The functions per tank that are assigned a relay depends on the order configuration. Possible functions are: HH, H, L, LL and Leak.



The actuators are not included in the scope of supply.

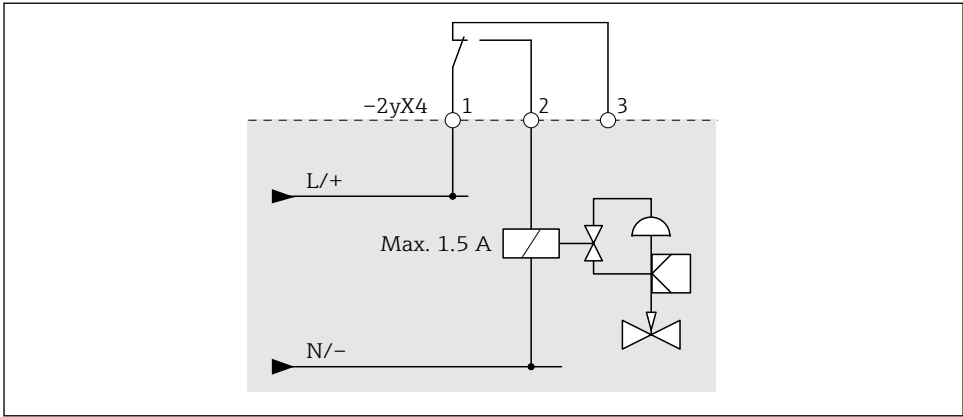

15 Connection example for valve control, valve closed without current; alarm relay activated in the "Good" state, change-over contact (1) and NO contact (2) closed

- y 1 = HH, 2 = H, 3 = L, 4 = LL, 5 = Leak
- 1 Changeover contact
- 2 NO contact
- 3 NC contact

System alarm relay

You can signalize the system status or relay it to another system via the existing floating changeover contact.

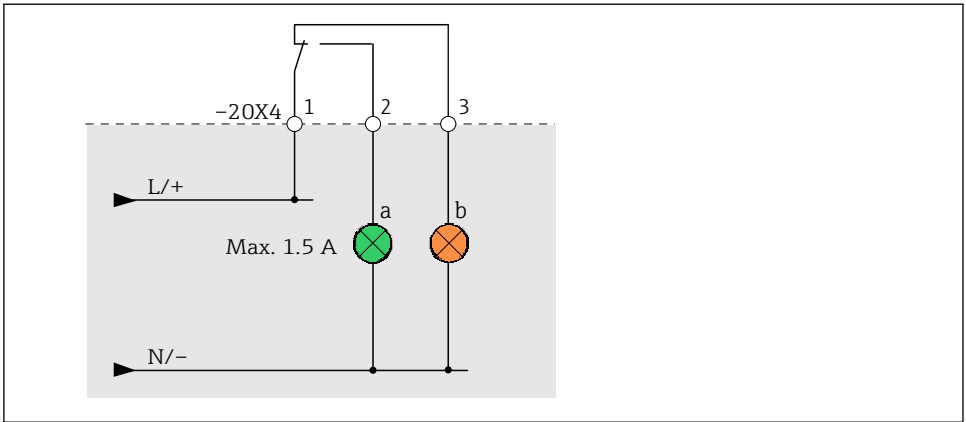

16 Connection example for signalization of the system status; system alarm relay activated in the "Good" state, change-over contact (1) and NO contact (2) closed

- a System status is "Good": OK or WARNING
- b System status is ERROR
- 1 Changeover contact
- 2 NO contact
- 3 NC contact

Output signal: alarm siren with activation feedback

Please refer to the separate wiring diagram for the electrical connection.

Output signal: alarm strobe with activation feedback

Please refer to the separate wiring diagram for the electrical connection.

6.3 Ensuring the degree of protection

- The cabinet is only approved for indoor use (IP54)
 - The field signalization system meets all the requirements of IP66/67 protection
 - Please refer to the relevant documentation for the degree of protection of the sensors and actuators
1. Ensure that the housing seals are clean and mounted correctly. Dry, clean or replace the seals if necessary.
 2. Tighten all housing screws and screw covers.
 3. Tighten cable glands.

- 4. Ensure that moisture cannot penetrate the cable entry by laying the cable in such a way that it forms a U shape in front of the cable entry (**water trap**).

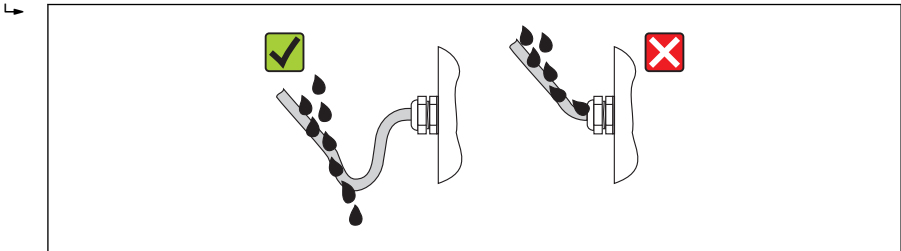

- 5. Seal off any unused cable entries using dummy plugs.

6.4 Post-connection check

Are the system, devices and cables undamaged (visual check)?	<input type="checkbox"/>
Do the cables comply with the requirements ?	<input type="checkbox"/>
Do the cables have adequate strain relief?	<input type="checkbox"/>
Are all cable glands installed, securely tightened and leak-tight? Cable run with water trap?	<input type="checkbox"/>
Does the supply voltage match the specifications on the nameplate?	<input type="checkbox"/>
Is the terminal assignment correct?	<input type="checkbox"/>
Are all housing covers installed and securely tightened?	<input type="checkbox"/>
Are all unused cable entries sealed with a dummy plug?	<input type="checkbox"/>
Are the cables of the field signalization system routed separately?	<input type="checkbox"/>

7 Operation options

The device is generally operated using the optional touch display integrated in the door of the control cabinet. If the touch display was not ordered, it is possible to connect to the system via a VNC client and operate the system via this client.

There is also a button for acknowledging alarms and an illuminated pushbutton to reset components, such as the alarm output relay and electronic device protective switches, to an operational state. The light of the illuminated pushbutton flashes to alert the user to the fact that a reset is necessary. There are built-in signal lamps in the cabinet door which signalize the state of the system (green: system status OK, orange: system status WARNING, red: system status ERROR).

Safety-oriented field signalization units, such as strobes and sirens, are also optionally available for order. Furthermore, users also have the option of making data available to a higher-level system (e.g. Modbus TCP).

8 Commissioning

8.1 Function check

Before commissioning the Overfill Prevention System:

Make sure that the post-installation and post-connection checks have been performed:

- "Post-installation" checklist, **Section 5.3** →  18
- "Post-connection" checklist, **Section 6.2** →  26

8.2 Switching on the Overfill Prevention System

Prerequisites:

- The system has been installed correctly.
- The electrical connection has been established correctly.

8.2.1 Switching on the Overfill Prevention System with an optional UPS



Damaged battery connection cable!

Risk of fatal injury from electric shock.

- ▶ When closing the front cover for the battery, do not pinch or damage the insulation of the battery connection cable.

In the case of a non-redundant power supply

1. Insert the fuse of the UPS battery →  27. See wiring diagram "+PS1-14G3".
2. Switch on the circuit breaker. See wiring diagram "+PS1-11F1".

In the case of a redundant power supply

1. Insert the fuse of the UPS battery →  27. See wiring diagram "+PS1-14G3".
2. Switch on the first circuit breaker. See wiring diagram "+PS1-11F1".
3. Switch on the second circuit breaker. See wiring diagram "+PS1-12F1".

Inserting the fuse of the UPS battery (+PS1-14G3)

1. Press the two locking lugs at the top of the battery housing simultaneously and swivel the front cover down.
2. Insert the fuse into the fuse holder.
3. Close the front cover. The locking lugs must snap into the attachment on the housing top.

8.2.2 Switching on the Overfill Prevention System without an optional UPS

In the case of a non-redundant power supply

- ▶ Switch on the circuit breaker. See wiring diagram "+PS1-11F1".

In the case of a redundant power supply

1. Switch on the first circuit breaker. See wiring diagram "+PS1-11F1".
2. Switch on the second circuit breaker. See wiring diagram "+PS1-12F1".

8.3 Configuring the Overfill Prevention System

1. Log an operator onto the system. The operator must at least have the "Operator" access level.
2. Acknowledge all the alarms and warnings via the **Acknowledge** built-in door button.
3. Reset the safety relays via the **Reset** built-in door button.
4. Assign a password for all users .
5. Set the correct local time .
6. Set the desired proof-test interval.
7. Perform an automated proof-test.
8. Perform a signaling proof-test.

 For detailed information on the individual steps, see Operating Instructions BA01787S.

8.4 Configuring sensors

- ▶ Configure the sensors as described in the relevant sensor documentation.

8.5 Performing the functional test

- ▶ Perform suitable tests to guarantee the safety function.

www.addresses.endress.com
