



Certificate of Compliance

Certificate: 2541184

Master Contract: 160686

Project: 70157647

Date Issued: October 13, 2017

Issued to: Endress + Hauser Flowtec AG
Kaegenstrasse 7
CH-4153 Reinach
SWITZERLAND
Attention: Frank Bonshab

The products listed below are eligible to bear the CSA Mark shown



Issued by:

E. Giusti
E. Giusti

PRODUCTS

CLASS 2258 02 - PROCESS CONTROL EQUIPMENT - For Hazardous Locations

CLASS 2258 82 - PROCESS CONTROL EQUIPMENT - For Hazardous Locations - Certified to US Standards

Class I, Division 1, Groups A, B, C and D

Prosonic Flow B 200 Types 9B2B**-C3*****+###, 9B2B**-CC*****+###, O9B2B**-C3*****+###, O9B2B**-CC*****+###, explosionproof with non intrinsically safe I/Os, integral intrinsically safe sensor and remote display when connected per installation drawing FES0191, which also specifies the maximum temperature code T6-T1 function of maximum ambient temperature -50°C to 60°C and maximum process temperature up to 80°C.

Class I, Division 2, Groups A, B, C and D

Prosonic Flow B 200 Types 9B2B**-C4*****+###, O9B2B**-C4*****+### FES0192, which also specifies the maximum temperature code T6-T1 function of maximum ambient temperature -60°C to 60°C and maximum process temperature up to 80°C.

Class I, Division 1, Groups A, B, C and D

Class II, Division 1, Groups E, F and G; Class III

Ex d[ia] IIC and AEx d[ia] IIC, Class I, Zone 1



Certificate: 2541184
Project: 70157647

Master Contract: 160686
Date Issued: October 13, 2017

Proline Promass A/E/F Types 8A2B**-C3*****+###, 8A2B**-C6*****+###, 8A2B**-CC*****+###, 8E2B**-C3*****+###, 8E2B**-C6*****+###, 8E2B**-CC*****+###, O8E2B**-C3*****+###, O8E2B**-C6*****+###, O8E2B**-CC*****+###, 8F2B**-C3*****+###, 8F2B**-C6*****+###, 8F2B**-CC*****+###, O8F2B**-C3*****+###, O8F2B**-C6*****+###, O8F2B**-CC*****+###, 8E2C**-C3*****+###, 8E2C**-CC*****+###, O8E2C**-C6*****+###, O8E2C**-CC*****+###, explosionproof with non intrinsically safe I/Os, integral intrinsically safe sensor and remote display when connected per installation drawing FES0169, which also specifies the maximum temperature code T6-T1 function of maximum ambient temperature -50°C to 60°C and maximum process temperature -50°C to 205°C; Enclosure Type 4X; Dual Seal.

Promag E/H/P/W 200 Types 5H2B**-C3*****+###, 5H2B**-C6*****+###, 5H2B**-CC*****+###, 5P2B**-C3*****+###, 5P2B**-C6*****+###, 5P2B**-CC*****+###, 5W2B**-C3*****+###, 5W2B**-C6*****+###, 5W2B**-CC*****+###, O5H2B**-C3*****+###, O5H2B**-C6*****+###, O5H2B**-CC*****+###, O5P2B**-C3*****+###, O5P2B**-C6*****+###, O5P2B**-CC*****+###, O5W2B**-C3*****+###, O5W2B**-C6*****+###, O5W2B**-CC*****+###, 5E2B**-C3*****+###, O5E2B**-C6*****+###, 5E2B**-CC*****+###, explosionproof with non intrinsically safe I/Os, integral intrinsically safe sensor and remote display when connected per installation drawing FES0206, which also specifies the maximum temperature code T6-T1 function of maximum ambient temperature -40°C to 60°C and maximum process temperature -40°C to 150°C; Enclosure Type 4X.

Prowirl C/D/F/R/O 200 Types 7*2B**-C3*****+###, 7*2B**-C6*****+###, 7*2B**-CC*****+###, O7*2B**-C3*****+###, O7*2B**-C6*****+###, O7*2B**-CC*****+###, and Prowirl D 200 Types 7D2C**-C3*****+###, 7D2C**-C6*****+###, 7D2C**-CC*****+###, O7D2C**-C3*****+###, O7D2C**-C6*****+###, O7D2C**-CC*****+###, and Prowirl F/R/O 200 Types 7*2C**-C3*****+###, 7*2C**-C6*****+###, 7*2C**-CC*****+###, O7*2C**-C3*****+###, O7*2C**-C6*****+###, O7*2C**-CC*****+###, explosionproof with non intrinsically safe I/Os, integral intrinsically safe sensor and remote display when connected per installation drawing FES0228, which also specifies the maximum temperature code T6-T1 function of maximum ambient temperature -50°C to 85°C and maximum process temperature up to 440°C. Enclosure Type 4X; Dual Seal.

Class I, Division 2, Groups A, B, C and D
Class II, Division 1, Groups E, F and G; Class III
Ex nA IIC and AEx nA IIC, Class I, Zone 2
Ex ec IIC and AEx nA IIC, Class I, Zone 2

Proline Promass A/E/F 200 Types 8A2B**-C4*****+###, 8A2B**-C7*****+###, O8A2B**-C4*****+###, O8A2B**-C7*****+###, 8E2B**-C4*****+###, 8E2B**-C7*****+###, O8E2B**-C4*****+###, O8E2B**-C7*****+###, 8F2B**-C4*****+###, 8F2B**-C7*****+###, O8F2B**-C4*****+###, O8F2B**-C7*****+###, 8E2C**-C4*****+###, O8E2C**-C7*****+###, non incensive



Certificate: 2541184
Project: 70157647

Master Contract: 160686
Date Issued: October 13, 2017

sensor and remote display when connected per installation drawing FES0170, which also specifies the maximum temperature code T6-T1 function of maximum ambient temperature -60°C to 60°C and maximum process temperature -50°C to 205°C; Enclosure Type 4X; Dual Seal.

Promag E/H/P/W 200 Types 5H2B**-C4*****+###, 5H2B**-C7*****+###, 5P2B**-C4*****+###, 5P2B**-C7*****+###, 5W2B**-C4*****+###, 5W2B**-C7*****+###, O5H2B**-C4*****+###, O5H2B**-C7*****+###, O5P2B**-C4*****+###, O5P2B**-C7*****+###, O5W2B**-C4*****+###, O5W2B**-C7*****+###, 5E2B**-C4*****+###, O5E2B**-C7*****+###, non incensive sensor and remote display when connected per installation drawing FES0207, which also specifies the maximum temperature code T6-T1 function of maximum ambient temperature -40°C to 60°C and maximum process temperature -40°C to 150°C; Enclosure Type 4X.

Prowirl C/D/F/R/O 200 Types 7*2B**-C4*****+###, 7*2B**-C7*****+###, O7*2B**-C4*****+###, O7*2B**-C7*****+###, and Prowirl D 200 Types 7*2C**-C4*****+###, 7*2C**-C7*****+###, O7*2C**-C4*****+###, O7*2C**-C7*****+###, and Prowirl F/R/O 200 Types 7*2C**-C4*****+###, 7*2C**-C7*****+###, O7*2C**-C4*****+###, O7*2C**-C7*****+###, non incensive sensor and remote display when connected per installation drawing FES0229, which also specifies the maximum temperature code T6-T1 function of maximum ambient temperature -60°C to 85°C and maximum process temperature up to 450°C. Enclosure Type 4X; Dual Seal

CLASS 2258 03 - PROCESS CONTROL EQUIPMENT - Intrinsically Safe and Non-Incensive Systems - For Hazardous Locations

CLASS 2258 83 - PROCESS CONTROL EQUIPMENT - Intrinsically Safe and Non-Incensive Systems - For Hazardous Locations - Certified to US Standards

Class I, Division 2, Groups A, B, C and D
Class II, Division 1, Groups E, F and G; Class III
Ex nL IIC and AEx nC IIC T6-T1, Class I, Zone 2
Ex ic IIC and AEx ic IIC T6-T1, Class I, Zone 2

Proline Promass A/E/F 200 Types 8A2B**-C4*****+###, 8A2B**-C7*****+###, O8A2B**-C4*****+###, O8A2B**-C7*****+###, 8E2B**-C4*****+###, 8E2B**-C7*****+###, O8E2B**-C4*****+###, O8E2B**-C7*****+###, 8F2B**-C4*****+###, 8F2B**-C7*****+###, O8F2B**-C4*****+###, O8F2B**-C7*****+###, 8E2C**-C4*****+###, O8E2C**-C7*****+###, non-incensive when connected per installation drawing FES0170, which also specifies the entity parameters and the maximum temperature code T6-T1 function of maximum ambient temperature -60°C to 60°C and maximum process temperature -50°C to 205°C; Enclosure Type 4X; Dual Seal.

Promag E/H/P/W 200 Types 5H2B**-C4*****+###, 5H2B**-C7*****+###, 5P2B**-C4*****+###, 5P2B**-C7*****+###, 5W2B**-C4*****+###, 5W2B**-C7*****+###, O5H2B**-C4*****+###, O5H2B**-C7*****+###, O5P2B**-C4*****+###, O5P2B**-C7*****+###, O5W2B**-C4*****+###, O5W2B**-C7*****+###, 5E2B**-C4*****+###, O5E2B**-C7*****+###, non-incensive when



Certificate: 2541184
Project: 70157647

Master Contract: 160686
Date Issued: October 13, 2017

connected per installation drawing FES0207, which also specifies the entity parameters and the maximum temperature code T6-T1 function of maximum ambient temperature -40°C to 60°C and maximum process temperature -40°C to 150°C; Enclosure Type 4X; Dual Seal.

Prowirl C/D/F/R/O 200 Types 7*2B**-C4*****+###, 7*2B**-C7*****+###, O7*2B**-C4*****+###, O7*2B**-C7*****+###, and Prowirl D 200 Types 7*2C**-C4*****+###, 7*2C**-C7*****+###, O7*2C**-C4*****+###, O7*2C**-C7*****+###, and Prowirl F/R/O 200 Types 7*2C**-C4*****+###, 7*2C**-C7*****+###, O7*2C**-C4*****+###, O7*2C**-C7*****+###, non incensive when connected per installation drawing FES0229, which also specifies the maximum temperature code T6-T1 function of maximum ambient temperature -60°C to 85°C and maximum process temperature up to 450°C. Enclosure Type 4X; Dual Seal.

CLASS 2258 04 - PROCESS CONTROL EQUIPMENT - Intrinsically Safe Entity - For Hazardous Locations
CLASS 2258 84 - PROCESS CONTROL EQUIPMENT - Intrinsically Safe Entity - For Hazardous Locations - Certified to US Standards

Class I, Division 1, Groups A, B, C and D

Prosonic Flow B 200 Types 9B2B**-C2*****+###, 9B2B**-CB*****+###, O9B2B**-C2*****+###, O9B2B**-CB*****+###, intrinsically safe with entity parameters Ui, Umax =30V, Ii, Imax = 300mA, Pi, Pmax = 1W, Ci = 5nF and 30nF depending on the models, Li = 0 when connected per installation drawing FES0190, which also specifies the maximum temperature code T6-T1 function of maximum ambient temperature -50°C to 60°C and maximum process temperature 0°C to 80°C.

Class I, Division 1, Groups A, B, C and D
Class II, Division 1, Groups E, F and G; Class III
Ex ia IIC and AEx ia IIC, Class I, Zone 1

Proline Promass A/E/F 200 Types 8A2B**-C2*****+###, 8A2B**-C5*****+###, 8A2B**-CB*****+###, O8A2B**-C2*****+###, O8A2B**-C5*****+###, O8A2B**-CB*****+###, 8E2B**-C2*****+###, 8E2B**-C5*****+###, 8E2B**-CB*****+###, O8E2B**-C2*****+###, O8E2B**-C5*****+###, O8E2B**-CB*****+###, 8F2B**-C2*****+###, 8F2B**-C5*****+###, 8F2B**-CB*****+###, O8F2B**-C2*****+###, O8F2B**-C5*****+###, O8F2B**-CB*****+###, 8E2C**-C2*****+###, 8E2C**-CB*****+###, O8E2C**-C5*****+###, O8E2C**-CB*****+###, intrinsically safe when connected per installation drawing FES0166, which also specifies the entity parameters the maximum temperature code T6-T1 function of maximum ambient temperature -50°C to 60°C and maximum process temperature -50°C to 205°C; Enclosure Type 4X; Dual Seal.

Promag E/H/P/W 200 Types 5H2B**-C2*****+###, 5H2B**-C5*****+###, 5H2B**-CB*****+###, 5P2B**-C2*****+###, 5P2B**-C5*****+###, 5P2B**-CB*****+###, 5W2B**-C2*****+###, 5W2B**-C5*****+###, 5W2B**-CB*****+###, 5E2B**-C2*****+###, 5E2B**-CB*****+###, O5H2B**-C2*****+###, O5H2B**-C5*****+###, O5H2B**-CB*****+###, O5P2B**-C2*****+###, O5P2B**-C5*****+###, O5P2B**-CB*****+###, intrinsically safe when connected per installation drawing FES0166, which also specifies the entity parameters the maximum temperature code T6-T1 function of maximum ambient temperature -50°C to 60°C and maximum process temperature -50°C to 205°C; Enclosure Type 4X; Dual Seal.



Certificate: 2541184
Project: 70157647

Master Contract: 160686
Date Issued: October 13, 2017

C5*****+###, O5P2B**-CB*****+###, O5W2B**-C2*****+###, O5W2B**-
C5*****+###, O5W2B**-CB*****+###, O5E2B**-C5*****+###, O5E2B**-
CB*****+###, intrinsically safe when connected per installation drawing FES0205, which also specifies
the maximum temperature code T6-T1 function of maximum ambient temperature -40°C to 60°C and maximum
process temperature -40°C to 150°C; Enclosure Type 4X, Dual Seal.

Class I, Division 1, Groups A, B, C and D
Class II, Division 1, Groups E, F and G; Class III
Ex ia IIC and AEx ia IIC, Class I, Zone 0

Prowirl C/D/F/R/O 200 Types 7*2B**-C2*****+###, 7*2B**-C5*****+###, 7*2B**-
CB*****+###, O7*2B**-C2*****+###, O7*2B**-C5*****+###, O7*2B**-
CB*****+###, and Prowirl D 200 Types 7D2C**-C2*****+###, 7D2C**-
C5*****+###, 7D2C**-CB*****+###, O7D2C**-C2*****+###,
O7D2C**-C5*****+###, O7D2C**-CB*****+###, and Prowirl F/R/O 200 Types
7*2C**-C2*****+###, 7*2C**-C5*****+###, 7*2C**-CB*****+###,
O7*2C**-C2*****+###, O7*2C**-C5*****+###, O7*2C**-
CB*****+###, intrinsically safe when connected per installation drawing FES0227, which also
specifies the entity parameters the maximum temperature code T6-T1 function of maximum ambient temperature
-50°C to 85°C and maximum process temperature from -50°C to 450°C; Enclosure Type 4X, dual seal.

APPLICABLE REQUIREMENTS

- CSA C22.2 No. 0-10 -General Requirements - Canadian Electrical Code, Part II
- CAN/CSA C22.2 No. 61010-1-12 - Safety Requirements for Electrical Equipment for Measurement, Control, and Laboratory Use - Part 1: General Requirements - Second Edition
- CSA C22.2 No. 25-1966 - Enclosures for Use in Class II, Groups E, F & G Hazardous Locations
- CAN/CSA C22.2 No. 94-M91 – Special Purpose Enclosures
- CSA C22.2 No. 213-2016 - Nonincendive electrical equipment for use in Class I and II, Division 2 and Class III, Divisions 1 and 2 hazardous (classified) locations
- CSA C22.2 No 60079-0: 15 - Explosive atmospheres - Part 0: Equipment - General requirements
- CSA C22.2 No 60079-11:14 - Explosive atmospheres - Part 11: Equipment protection by intrinsic safety “i”
- CSA C22.2 No 60079-15:16- Explosive atmospheres - Part 15: Equipment protection by type of protection “n”
- CSA C22.2 No 60079-1:16 - Explosive atmospheres - Part 1: Equipment protection by flameproof enclosures “d”
- CSA C22.2 No 60079-7:16 - Explosive atmospheres - Part 7: Equipment protection by Increased Safety “e”
- CSA C22.2 No 60079-26:16 - Explosive atmospheres - Part 26: Equipment with Equipment Protection Level (EPL) Ga
- FM 3810: 2005 - Approval Standard for Electrical Equipment for Measurement, Control, and Laboratory Use
- ANSI/ ISA-61010-1 (82.02.01): 2012 - Safety Requirements for Electrical Equipment for Measurement, Control, and Laboratory Use - Part 1 General Requirements
- FM 3600:2011 - Approval Standard for Electrical Equipment for use in Hazardous (Classified) Locations General Requirements



Certificate: 2541184
Project: 70157647

Master Contract: 160686
Date Issued: October 13, 2017

FM 3610:2015 - Approval Standard for Intrinsically Safe Apparatus and Associated Apparatus for Use in Class I, II, III, Division 1, Hazardous (Classified) Locations

FM 3611:2004 - Approval Standard for Nonincendive Electrical Equipment for Use in Class I and II, Division 2, and Class III Divisions 1 and 2, Hazardous (Classified) Locations

FM 3615: 2006 - Approval Standard for Explosionproof Electrical Equipment General Requirements

FM 3616:2011 - Approval Standard for Dust Ignitionproof Electrical Equipment for Use in Hazardous (Classified) Locations General Requirements

NEMA 250:2014 - Enclosures for Electrical Equipment (1,000 Volts Maximum)

ANSI/IEC 60529:2004 - Degrees of Protection Provided by Enclosures (IP Code) (identical national adoption)

ISA 60079-0 (12.00.01): 2013 - Explosive atmospheres – Part 0: Equipment – General Requirements

ISA 60079-11 (12.02.01): 2014 - Explosive atmospheres - Part 11: Equipment protection by intrinsic safety “i”

ISA 60079-15 (12.12.02): 2013 - Explosive atmospheres – Part 15: Equipment protection by type of protection “n”

ISA-60079-26 (12.00.03)-2011 Explosive atmospheres - Part 26: Equipment for Use in Class I, Zone 0 Hazardous (Classified) Locations

ISA 12.27.01-2011 - Requirements for Process Sealing Between Electrical Systems and Flammable or Combustible Process Fluids

MARKINGS

The manufacturer is required to apply the following markings:

- Products shall be marked with the markings specified by the particular product standard.
- Products certified for Canada shall have all Caution and Warning markings in both English and French.

Additional bilingual markings not covered by the product standard(s) may be required by the Authorities Having Jurisdiction. It is the responsibility of the manufacturer to provide and apply these additional markings, where applicable, in accordance with the requirements of those authorities.

The products listed are eligible to bear the CSA Mark shown with adjacent indicators 'C' and 'US' for Canada and US (indicating that products have been manufactured to the requirements of both Canadian and U.S. Standards) or with adjacent indicator 'US' for US only or without either indicator for Canada only.

Compliance of nameplates are covered under Letter of Attestation (CSA File 2095429) where a marking may be used such as one of the following plates

- Wölco Type 3105 2008 or
- Eltex Type LAZRetch PM-200 (Top-Script 101 720) or
- 3M Type 7847 or
- stainless steel

Surface material:

- powder coated aluminum IGP Type Durapol 6403A or
- stainless steel

Nameplates are as per drawing FEK2508-0001, FEK2509-0001, FEK3066-0001, FEK3067-0000, FEK3321-0001 and FEK3117-0001. Applicable installation drawings FES0166, FES0169, FES0170, FES 190, FES191, FES192, FES204 are shipped with each product.

Notes:

This page applies to versions with extended order code:
 approval option: C2, C5
 IO option: A, B, C, D, E, G

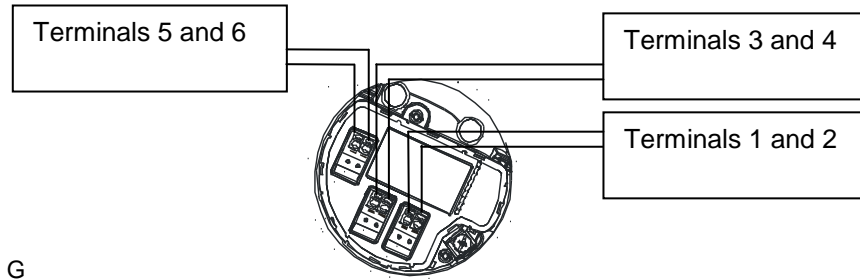

IS / Ex ia / AEx ia installation:

1. IO option: A

Terminals 1 and 2:

Ui	Ii	Pi	Ci	Li
30 V	300 mA	1 W	5 nF	0

2. IO option: B

Terminals 1 and 2:

Ui	Ii	Pi	Ci	Li
30 V	300 mA	1 W	5 nF	0

Terminals 3 and 4:

Ui	Ii	Pi	Ci	Li
30 V	300 mA	1 W	6 nF	0

3. IO option: C

Terminals 1 and 2:

Ui	Ii	Pi	Ci	Li
30 V	300 mA	1 W	30 nF	0

Terminals 3 and 4:

Ui	Ii	Pi	Ci	Li
30 V	300 mA	1 W	30 nF	0

4. IO option: D

Terminals 1 and 2:

Ui	Ii	Pi	Ci	Li
30 V	300 mA	1 W	5 nF	0

Terminals 3 and 4:

Ui	Ii	Pi	Ci	Li
30 V	300 mA	1 W	6 nF	0

Terminals 5 and 6:

Ui	Ii	Pi	Ci	Li
30 V	300 mA	1 W	5 nF	0

5. IO option: E, G

Terminals 1 and 2:

Ui	Ii	Pi	Ci	Li
17.5 V	550 mA	5.5 W	5 nF	10 µH

or

Ui	Ii	Pi	Ci	Li
30 V	300 mA	1.2 W	5 nF	10 µH

Terminals 3 and 4:

Ui	Ii	Pi	Ci	Li
30 V	300 mA	1 W	6 nF	0

Installation Remote Display:

6. IO option: A, B, C, D, E, G
 Display option: L, M

Circuit to remote display in type of protection intrinsic safety IS / Ex ia / AEx ia

Prepared for FHX50:

Uo	Io	Po	Co	Lo
7.3 V	157 mA	362 W	388 nF	149 µH

- 7. All circuits can be installed in hazardous areas requiring equipment certified for Class I Division 1
- 8. Only for connection of an E+H Service Interface with $U_o \leq 7.3V$, e.g. FXA291.
- 9. Entity parameters remain to be unchanged if OVP module or TRM module is used

Aenderungen:	A	04.05.2012 / Bn	F	Alle gesetzlichen Urheberrechte. vorbehalten. Diese Zeichnung darf ohne unsere Genehmigung weder vervielfältigt werden noch dritten Personen und Konkurrenzfirmen zugänglich gemacht werden.	Ersetzt durch: Ersatz für: Ersteller: FES / Bn FILE: FES0204E.doc
	B	05.09.2012 / BIF	G		
	C	24.05.2013 / Bn	H		
	D	16.09.2013 / Bn	J		
	E	28.07.2017 / Bn	K		

Amendment to Control Drawing CSA, cCSA_{US}
 Class I Division 1, Class I Division 2
 Electrical Parameter
 Promass 200, Prosonic 200, Promag 200, Prowirl 200

Massstab	Gezeichnet	04.05.2012	Bn
	Geprüft		
	Ex-geprüft	28.07.2017	Bn
	Gesehen		



Flowtec AG, Kägenstrasse 7, CH-4153 Reinach BL1, Postfach

FES0204E

1/4

Notes:

This page applies to versions with extended order code covering:
 approval option: C4, C7
 IO option: A, B, C, D, E, G

NIFW / Ex nL / Ex ic / AEx nC / AEx ic installation:

1. IO option: A

Terminals 1 and 2:

Ui	Ii	Pi	Ci	Li
35 V	n.a.	1 W	5 nF	0

2. IO option: B

Terminals 1 and 2:

Ui	Ii	Pi	Ci	Li
35 V	n.a.	1 W	5 nF	0

Terminals 3 and 4:

Ui	Ii	Pi	Ci	Li
35 V	n.a.	1 W	6 nF	0

3. IO option: C

Terminals 1 and 2:

Ui	Ii	Pi	Ci	Li
30 V	n.a.	1 W	30 nF	0

Terminals 3 and 4:

Ui	Ii	Pi	Ci	Li
30 V	n.a.	1 W	30 nF	0

4. IO option: D

Terminals 1 and 2:

Ui	Ii	Pi	Ci	Li
35 V	n.a.	1 W	5 nF	0

Terminals 3 and 4:

Ui	Ii	Pi	Ci	Li
35 V	n.a.	1 W	6 nF	0

Terminals 5 and 6:

Ui	Ii	Pi	Ci	Li
35 V	n.a.	1 W	5 nF	0

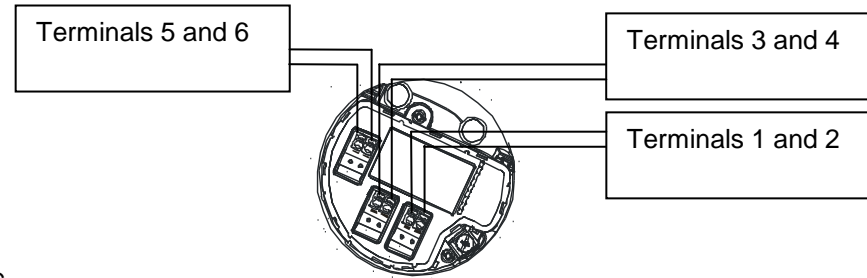

5. IO option: E, G

Terminals 1 and 2:

Ui	Ii	Pi	Ci	Li
17.5 V	n.a.	n.a.	5 nF	10 µH

or

Ui	Ii	Pi	Ci	Li
32 V	n.a.	n.a.	5 nF	10 µH

Terminals 3 and 4:

Ui	Ii	Pi	Ci	Li
35 V	300 mA	1 W	6 nF	0

Installation Remote Display:

6. IO option: A, B, C, D, E, G
 Display option: L, M

Circuit to remote display in type of protection intrinsic safety IS / Ex ia / AEx ia

Prepared for FHX50:

Uo	Io	Po	Co	Lo
7.3 V	157 mA	362 W	388 nF	149 µH

- 7. All circuits can be installed in hazardous areas requiring equipment certified for Class I Division 1
- 8. Only for connection of an E+H Service Interface with $U_o \leq 7.3V$, e.g. FXA291.
- 9. Entity parameters remain to be unchanged if OVP module or TRM module is used

Aenderungen:	A	04.05.2012 / Bn	F	Alle gesetzlichen Urheberrechte. vorbehalten. Diese Zeichnung darf ohne unsere Genehmigung weder vervielfältigt werden noch dritten Personen und Konkurrenzfirmen zugänglich gemacht werden.	Ersetzt durch: Ersatz für: Ersteller: FES / Bn FILE: FES0204E.doc
	B	05.09.2012 / BIF	G		
	C	24.05.2013 / Bn	H		
	D	16.09.2013 / Bn	J		
	E	28.07.2017 / Bn	K		

Amendment to Control Drawing CSA, cCSA_{US}
 Class I Division 1, Class I Division 2
 Electrical Parameter
 Promass 200, Prosonic 200, Promag 200, Prowirl 200

Massstab	Gezeichnet	04.05.2012	Bn
	Geprüft		
	Ex-geprüft	28.07.2017	Bn
	Gesehen		



Notes:

This page applies to versions with extended order code covering:

XP / Ex d / AEx d version :

approval option: C3, C6

IO option: A, B, C, D, E, G

NI / Ex nA / Ex ec / AEx nA version:

approval option: C4, C7

IO option: A, B, C, D, E, G

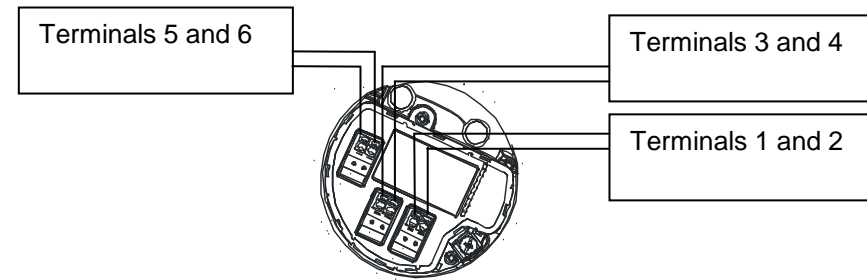

	<u>XP / Ex d / AEx d installation</u>	<u>NI / Ex nA / Ex ec / AEx nA installation</u>
IO option: A	Terminals 1 and 2: $U_m = 250 \text{ Vac}, U_N = 35 \text{ Vdc}$	Terminals 1 and 2: $U_m = 250 \text{ Vac}, U_N = 35 \text{ Vdc}$
IO option: B	Terminals 1 and 2, Terminals 3 and 4: $U_m = 250 \text{ Vac}, U_N = 35 \text{ Vdc}, P_{max} = 1W$	Terminals 1 and 2, Terminals 3 and 4: $U_m = 250 \text{ Vac}, U_N = 35 \text{ Vdc}, P_{max} = 1W$
IO option: C	Terminals 1 and 2, Terminals 3 and 4: $U_m = 250 \text{ Vac}, U_N = 30 \text{ Vdc}$	Terminals 1 and 2, Terminals 3 and 4: $U_m = 250 \text{ Vac}, U_N = 30 \text{ Vdc}$
IO option: D	Terminals 1 and 2, 3 and 4, 5 and 6: $U_m = 250 \text{ Vac}, U_N = 35 \text{ Vdc}$	Terminals 1 and 2, 3 and 4, 5 and 6: $U_m = 250 \text{ Vac}, U_N = 35 \text{ Vdc}$
IO option: E, G	Terminals 1 and 2: $U_m = 250 \text{ Vac}, U_N = 32 \text{ Vdc}, P_{max} = 0.88W$ Terminals 3 and 4: $U_m = 250 \text{ Vac}, U_{NI} = 35 \text{ Vdc}, P_{max} = 1W$	Terminals 1 and 2: $U_m = 250 \text{ Vac}, U_N = 32 \text{ Vdc}, P_{max} = 0.88W$ Terminals 3 and 4: $U_m = 250 \text{ Vac}, U_{NI} = 35 \text{ Vdc}, P_{max} = 1W$

Only for connection of an E+H Service Interface with $U_o \leq 7.3V$, e.g. FXA291.

Installation Remote Display:

IO option: A, B, C, D, E, G

Display option: L, M

XP / Ex d / AEx d version :

Circuit to remote display in type of protection intrinsic safety
IS / Ex ia / AEx ia

Prepared for FHX50:

U_o	I_o	P_o	C_o	L_o
7.3 V	157 mA	362 W	388 nF	149 μ H

NI / Ex nA / AEx nA version:

$U_N = 5 \text{ Vdc}$

Änderungen:	A	04.05.2012 / Bn	F		Alle gesetzlichen Urheberrechte vorbehalten. Diese Zeichnung darf ohne unsere Genehmigung weder vervielfältigt werden noch dritten Personen und Konkurrenzfirmen zugänglich gemacht werden.	Ersetzt durch: Ersatz für: Ersteller: FES / Bn FILE: FES0204E.doc
	B	05.09.2012 / BIF	G			
	C	24.05.2013 / Bn	H			
	D	16.09.2013 / Bn	J			
	E	28.07.2017 / Bn	K			

Amendment to Control Drawing CSA, cCSA _{US} Class I Division 1, Class I Division 2 Electrical Parameter Promass 200, Prosonic 200, Promag 200, Prowirl 200	Massstab	Gezeichnet	04.05.2012	Bn
		Geprüft		
		Ex-geprüft	28.07.2017	Bn
		Gesehen		



Flowtec AG, Kägenstrasse 7, CH-4153 Reinach BL1, Postfach

FES0204E

3/4

Notes:

This page applies to versions with extended order code covering:
 approval option: C2, C5 and C4, C7 if installed as non-incendive fieldwiring
 IO option: A, B, C, D, E, G

Profibus PA connector

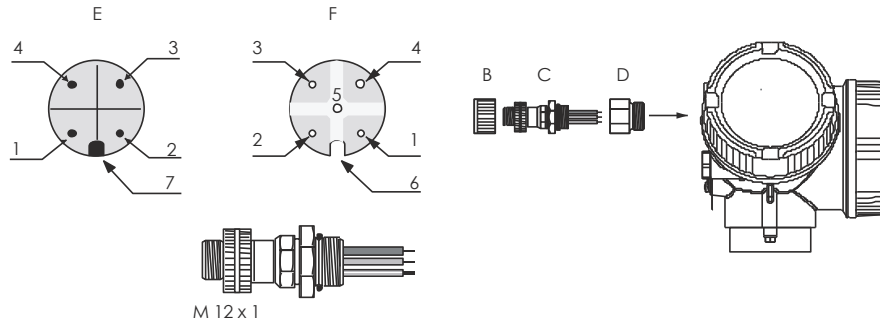

B = Protection cap for connector, C = Fieldbus connector,
 D = Thread adapter E = Connector on housing (male),
 F = Connector (female)

Pin assignment:
 Profibus PA
 1 = Brown wire, PA+ (terminal 26)
 2 = Not connected
 3 = Blue wire, PA- (terminal 27)
 4 = Black wire, ground
 5 = Female connector not assigned
 6 = Positioning groove
 7 = Positioning key

Fieldbus Foundation connector

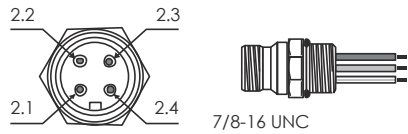

Fieldbus Foundation
 2.1 = Brown wire, FF+ (terminal 26)
 2.2 = Blue wire, FF- (terminal 27)
 2.3 = Grey wire, ground
 2.4 = Not assigned

Aenderungen:	A	04.05.2012 / Bn	F	Alle gesetzlichen Urheberrechte. vorbehalten. Diese Zeichnung darf ohne unsere Genehmigung weder vervielfältigt werden noch dritten Personen und Konkurrenzfirmen zugänglich gemacht werden.	Ersetzt durch: Ersatz für: Ersteller: FES / Bn FILE: FES0204E.doc
	B	05.09.2012 / BIF	G		
	C	24.05.2013 / Bn	H		
	D	16.09.2013 / Bn	J		
	E	28.07.2017 / Bn	K		

Amendment to Control Drawing CSA, cCSA_{US}
 Class I Division 1, Class I Division 2
 Electrical Parameter
 Promass 200, Prosonic 200, Promag 200, Prowirl 200

Massstab	Gezeichnet	04.05.2012	Bn
	Geprüft		
	Ex-geprüft	28.07.2017	Bn
	Gesehen		



Flowtec AG, Kägenstrasse 7, CH-4153 Reinach BL1, Postfach

FES0204E

4/4

Promag E/H/P/W 200

Hazardous Locations: Class I Division 1 Groups ABCD;
 Class II Division 1 Groups EFG and Class III;
 Class I Zone 1 Group IIC T6-T1;
 Ex ia IIC T6-T1; AEx ia IIC T6-T1

This control drawing applies to ext. order code:

5E2B**-C2*****+###, 5E2B**-C5*****+###,
 O5E2B**-C2*****+###, O5E2B**-C5*****+###,
 5H2B**-C2*****+###, 5H2B**-C5*****+###,
 O5H2B**-C2*****+###, O5H2B**-C5*****+###,
 5P2B**-C2*****+###, 5P2B**-C5*****+###,
 O5P2B**-C2*****+###, O5P2B**-C5*****+###,
 5W2B**-C2*****+###, 5W2B**-C5*****+###,
 O5W2B**-C2*****+###, O5W2B**-C5*****+###

Notes:

- FOR DATA OF SUPPLY VOLTAGE SEE ADDITIONAL DRAWING "FES0204" FOR APPROVAL OPTION "C2" AND "C5" AS AMENDMENT TO THIS CONTROL DRAWING
- Control room equipment shall not use or generate more than 250 V rms.
- Caution: Use supply wires suitable for 20 °C above ambient temperature
- Installation of transmitter circuit wiring according to Canadian Electrical Code (CEC) resp. National Electrical Code (NEC) using threaded conduit or other wiring methods in accordance with articles 500 to 510.
- Install all Intrinsically Safe Circuits per Canadian Electrical Code (CEC) Part I Section 18 and Appendix F resp. per National Electrical Code (NEC) ANSI/NFPA 70 and ISA RP 12.6 respecting the Explosionproof Integrity of the enclosure.
- Class II Group G: The surface temperature of the apparatus cannot exceed 165 °C / 329°F.
- The service interface FXA 291 can be connected to the transmitter when explosive atmosphere is present.
- Warning: SUBSTITUTION OF COMPONENTS MAY IMPAIR INTRINSIC SAFETY

Additional Notes to Remote Display type FHX50:

- Observe additional documentation for Remote Display type FHX50 if used.
- The connection circuit for Remote Display provides an intrinsically safe circuit with type of protection IS, Ex ia, AEx ia. For data of supply voltage see additional drawing "FES0204" as amendment to this control drawing.
- Cable parameter for Remote Display type FHX50 (Transmitter to Remote Display) for type of protection NIFW, Ex nL or AEx nC: max. length 60m, C_c ≤ 0.2nF/m, L_c ≤ 1µH/m or C_c ≤ 125nF, L_c ≤ 149µH

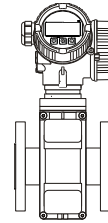

Promag P 200
Promag E 200

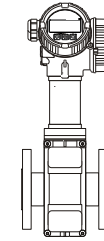

Promag *200
with neck extension

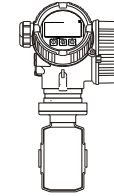

Promag H 200

Ambient temperature: -40 °C ... +60 °C
 Fluid temperature: -20 °C ... +130 °C for PTFE liner or
 -40 °C ... +130 °C for PTFE liner, depending product version
 -20 °C ... +150 °C for PFA liner or
 -40 °C ... +150 °C for PFA liner, depending product version

The liner limits the temperature range for fluid temperature of the flow meter (see marking on the product). The following table gives the general limits for the relation of max. ambient temperature and max. fluid temperature dependent the temperature class required:

T _a ³⁾	T _{Fluid}					
	T6 (85°C)	T5 (100°C)	T4 (135°C)	T3 (200°C)	T2 (300°C)	T1 (450°C)
40°C ¹⁾	80°C	95°C	130°C	150°C	150°C	150°C
55°C	--	95°C	130°C	150°C	150°C	150°C
60°C ²⁾	--	95°C	130°C	150°C	150°C	150°C

¹⁾ T_a = 35°C for I/O code D
²⁾ Only for I/O code A, E, G and I/O code B with pulse/frequ input limited to 0.85 W.
³⁾ For installation with OVP or TRM in T5 or T6: T_a = T_a - 2°C

Aenderungen:	A	09.05.2012 / UD	F	Alle gesetzlichen Urheberrechte vorbehalten. Diese Zeichnung darf ohne unsere Genehmigung weder vervielfältigt werden noch dritten Personen und Konkurrenzfirmen zugänglich gemacht werden.	Ersetzt durch: Ersatz für: Ersteller: FES / UD FILE: FES0205C.doc
	B	24.05.2013 / Bn	G		
	C	04.02.2014 / Bn	H		
	D		J		
	E		K		

Installation Drawing CSA and cCSA _{US} Cl.I Div.1, Zone 1 IS, Ex i version Promag E/H/P/W 200	Massstab	Gezeichnet	09.05.2012	UD
		Geprüft		
		Ex-geprüft	04.02.2014	Bn
		Gesehen		