

Brief Operating Instructions

Cerabar PMC71B

Process pressure measurement
HART



These Instructions are Brief Operating Instructions; they are not a substitute for the Operating Instructions pertaining to the device.

Detailed information about the device can be found in the Operating Instructions and the other documentation:

Available for all device versions via:

- Internet: www.endress.com/deviceviewer
- Smart phone/tablet: *Endress+Hauser Operations App*

1 Associated documentation



A0023555

2 About this document

2.1 Document function

The Brief Operating Instructions contain all the essential information from incoming acceptance to initial commissioning.

2.2 Symbols

2.2.1 Safety symbols



This symbol alerts you to a dangerous situation. Failure to avoid this situation will result in serious or fatal injury.

⚠ WARNING

This symbol alerts you to a dangerous situation. Failure to avoid this situation can result in serious or fatal injury.

⚠ CAUTION

This symbol alerts you to a dangerous situation. Failure to avoid this situation can result in minor or medium injury.

ℹ NOTICE

This symbol contains information on procedures and other facts which do not result in personal injury.

2.2.2 Electrical symbols

Ground connection: \perp

Terminal for connection to the grounding system.

2.2.3 Symbols for certain types of information

Permitted: 

Procedures, processes or actions that are permitted.

Forbidden: 

Procedures, processes or actions that are forbidden.

Additional information: 

Reference to documentation: 

Reference to page: 

Series of steps: 1, 2, 3

Result of an individual step: 



2.2.4 Symbols in graphics

Item numbers: 1, 2, 3 ...

Series of steps: 1, 2, 3

Views: A, B, C, ...

2.2.5 Symbols on the device

Safety instructions:  → 

Observe the safety instructions contained in the associated Operating Instructions.

2.2.6 Communication symbols

2.3 Registered trademarks

HART®

Registered trademark of the FieldComm Group, Austin, Texas, USA

Bluetooth®

The Bluetooth® wordmark and logos are registered trademarks of Bluetooth SIG, Inc. and any use of these trademarks by Endress+Hauser is licensed. Other trademarks and trade names are those of their respective owners.

Apple®

Apple, the Apple logo, iPhone, and iPod touch are trademarks of Apple Inc., registered in the U.S. and other countries. App Store is a service mark of Apple Inc.

Android®

Android, Google Play and the Google Play logo are trademarks of Google Inc.

KALREZ®

Registered trademark of DuPont Performance Elastomers L.L.C., Wilmington, USA

3 Basic safety instructions

3.1 Requirements for the personnel

The personnel for installation, commissioning, diagnostics and maintenance must fulfill the following requirements:

- ▶ Trained, qualified specialists must have a relevant qualification for this specific function and task
- ▶ Are authorized by the plant owner/operator
- ▶ Are familiar with federal/national regulations
- ▶ Before beginning work, the specialist staff must have read and understood the instructions in the Operating Instructions and supplementary documentation as well as in the certificates (depending on the application)
- ▶ Follow instructions and comply with conditions

The operating personnel must fulfill the following requirements:

- ▶ Being instructed and authorized according to the requirements of the task by the facility's owner-operator
- ▶ Following the instructions in these Operating Instructions

3.2 Intended use

The Cerabar is a pressure transmitter for measuring level and pressure.

3.2.1 Incorrect use

The manufacturer is not liable for damage caused by improper or non-intended use.

Verification for borderline cases:

- ▶ For special fluids and fluids for cleaning, Endress+Hauser is glad to provide assistance in verifying the corrosion resistance of fluid-wetted materials, but does not accept any warranty or liability.

3.3 Workplace safety

When working on and with the device:

- ▶ Wear the required personal protective equipment according to federal/national regulations.
- ▶ Switch off the supply voltage before connecting the device.

3.4 Operational safety

Risk of injury!

- ▶ Operate the device only if it is in proper technical condition, free from errors and faults.
- ▶ The operator is responsible for the interference-free operation of the device.

Modifications to the device

Unauthorized modifications to the device are not permitted and can lead to unforeseeable dangers:

- ▶ If, despite this, modifications are required, consult with Endress+Hauser.

Repair

To ensure continued operational safety and reliability:

- ▶ Carry out repairs on the device only if they are expressly permitted.
- ▶ Observe federal/national regulations pertaining to the repair of an electrical device.
- ▶ Use original spare parts and accessories from Endress+Hauser only.

Hazardous area

To eliminate the risk of danger to persons or the facility when the device is used in the approval-related area (e.g. explosion protection, pressure equipment safety):

- ▶ Check the nameplate to verify if the device ordered can be put to its intended use in the approval-related area.
- ▶ Observe the specifications in the separate supplementary documentation that is an integral part of these Instructions.

3.5 Product safety

This device is designed in accordance with good engineering practice to meet state-of-the-art safety requirements, has been tested, and left the factory in a condition in which it is safe to operate.

It meets general safety standards and legal requirements. It also complies with the EC directives listed in the device-specific EC Declaration of Conformity. Endress+Hauser confirms this by affixing the CE mark to the device.

3.6 Functional Safety SIL (optional)

The Functional Safety Manual must be strictly observed for devices that are used in functional safety applications.

3.7 IT security

Endress+Hauser can only provide a warranty if the device is installed and used as described in the Operating Instructions. The device is equipped with security mechanisms to protect it against any inadvertent changes to the device settings. IT security measures in line with operators' security standards and designed to provide additional protection for the device and device data transfer must be implemented by the operators themselves.

3.8 Device-specific IT security

The device offers specific functions to support protective measures by the operator. These functions can be configured by the user and guarantee greater in-operation safety if used correctly. An overview of the most important functions is provided in the following section:

- Write protection via hardware write protection switch
- Access code to change the user role (applies for operation via display, Bluetooth, or FieldCare, DeviceCare, Asset Management Tools (e.g. AMS, PDM)

4 Incoming acceptance and product identification

4.1 Incoming acceptance

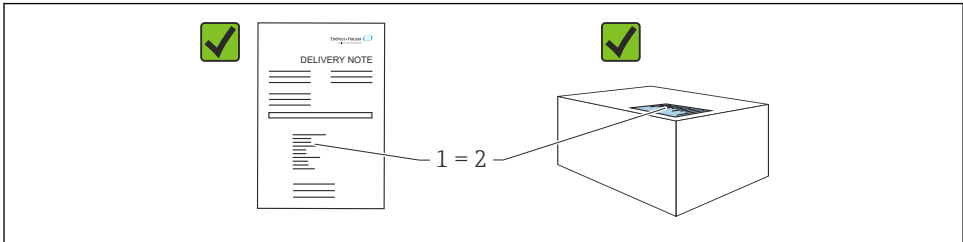

A0016870

- Is the order code on the delivery note (1) identical to the order code on the product sticker (2)?
- Are the goods undamaged?
- Do the data on the nameplate correspond to the order specifications and the delivery note?
- Is the documentation available?
- If required (see nameplate): are the Safety Instructions (XA) provided?



If you can answer "no" to any of these questions, please contact Endress+Hauser.

4.2 Storage and transport

4.2.1 Storage conditions

- Use the original packaging
- Store the device in clean and dry conditions and protect from damage caused by shocks

Storage temperature range

See Technical Information.

4.2.2 Transporting the product to the measuring point

WARNING

Incorrect transport!

Housing and membrane may become damaged, and there is a risk of injury!

- ▶ Transport the device to the measuring point in the original packaging.

5 Mounting

5.1 Mounting requirements

5.1.1 General instructions

- Do not clean or touch the membrane with hard and/or pointed objects.
- Do not remove the protection on the membrane until just before installation.

Always firmly tighten the housing cover and the cable entries.

1. Counter-tighten the cable entries.
2. Tighten the coupling nut.

5.1.2 Installation instructions

- The devices are mounted according to the same guidelines as pressure gauges (DIN EN837-2)
- To ensure optimal readability of the local display, adjust the housing and local display
- Endress+Hauser offers a mounting bracket to mount the device on pipes or walls
- Use flushing rings for flanges if there is a risk of medium buildup or clogging at the process connection
 - The flushing ring is clamped between the process connection and process
 - Material buildup in front of the membrane is flushed away, and the pressure chamber is vented, via the two lateral flushing holes
- When measuring in media containing solids (e.g. dirty liquids), installing separators and drain valves is useful for capturing and removing sediment

- Using a valve manifold allows for easy commissioning, installation and maintenance without interrupting the process
- When mounting the device, establishing the electrical connection and during operation: prevent the penetration of moisture into the housing
- Point the cable and plug downwards as much as possible to prevent moisture from entering (e.g. rainwater or condensation)

5.1.3 Installation instructions for thread

- Device with G 1 ½" thread:
 - Place the flat seal on the sealing surface of the process connection
 - Avoid additional strain on the membrane: do not seal the thread with hemp or similar materials
- Device with NPT thread:
 - Wrap Teflon tape around the thread to seal it
 - Tighten the device at the hexagon bolt only; do not turn it by the housing
 - When screwing in, do not overtighten the thread; tighten the NPT thread to the required depth according to the standard
- For the following process connections, a tightening torque of max. 40 Nm (29.50 lbf ft) is specified:
 - Thread ISO228 G ½" with flush membrane
 - Thread DIN13 M20 x 1.5 with flush membrane
 - NPT ¾" with flush membrane

Mounting devices with PVDF thread

WARNING

Risk of damage to process connection!

Risk of injury!

- ▶ Devices with a PVDF thread must be installed with the mounting bracket provided!
- ▶ PVDF is only intended for metal-free applications!

WARNING

Material fatigue from pressure and temperature!

Risk of injury if parts burst! The thread can become loose if exposed to high pressure and temperature loads.

- ▶ Check the leak-tight integrity of the thread regularly.
- ▶ Use Teflon tape to seal the ½" NPT thread.

5.1.4 Orientation

NOTICE

Damage to the device!

If a heated device is cooled during a cleaning process (e.g. by cold water), a vacuum develops for a short time. As a result of this, moisture can enter the measuring cell via the pressure compensation element (1).

- ▶ Mount the device as follows.

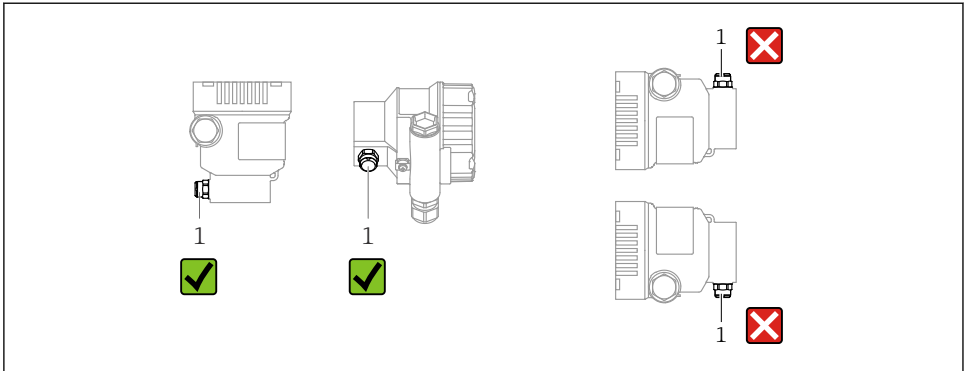

A0038723

- Keep the pressure compensation element (1) free from contamination
- A position-dependent zero point shift (when the vessel is empty the measured value does not display zero) can be corrected
- The use of shutoff devices and/or water pocket pipes is recommended for mounting
- The orientation depends on the measuring application

5.2 Mounting the device

5.2.1 Pressure measurement in gases

Mount the device with the shutoff device above the tapping point so that any condensate can flow into the process.

5.2.2 Pressure measurement in vapors

A water pocket pipe reduces the temperature to almost the ambient temperature. The defined water column only causes minimal (negligible) measured errors and minimal (negligible) thermal effects on the device.

Observe the maximum permitted ambient temperature of the transmitter!

- Ideally, mount the device with the O-shaped water pocket pipe below the tapping point
The device may also be mounted above the tapping point
- Fill the water pocket pipe with liquid before commissioning

5.2.3 Pressure measurement in liquids

Mount the device with the shutoff device below or at the same level as the tapping point.

5.2.4 Level measurement

- Always mount the device below the lowest measuring point
- Do not install the device at the following positions:
 - In the filling curtain
 - In the tank outlet
 - In the suction area of a pump
 - At a point in the tank which could be affected by pressure pulses from the agitator
- Mount the device downstream from a shutoff device: the calibration and function check can be carried out more easily

5.2.5 Closing the housing cover

NOTICE

Thread and housing cover damaged from dirt and fouling!

- ▶ Remove fouling (e.g. sand.) on the thread of the cover and housing.
- ▶ If you continue to encounter resistance when closing the cover, check the thread again for fouling.



Housing thread

The thread of the electronics and connection compartment is coated with lubricant varnish.

- ✘ Avoid additional lubrication.

6 Electrical connection

6.1 Connecting requirements

6.1.1 Potential equalization

The protective ground on the device must not be connected. If necessary, the potential matching line can be connected to the outer ground terminal of the device before the device is connected.

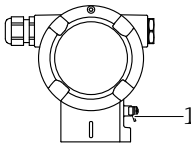

A0045412

- 1 Ground terminal for connecting the potential matching line

⚠ WARNING

Explosion Hazard!

- ▶ Please refer to the separate documentation on applications in hazardous areas for the safety instructions.



For optimum electromagnetic compatibility:

- Keep the potential matching line as short as possible
- Maintain a cross-section of at least 2.5 mm² (14 AWG)

6.2 Connecting the device

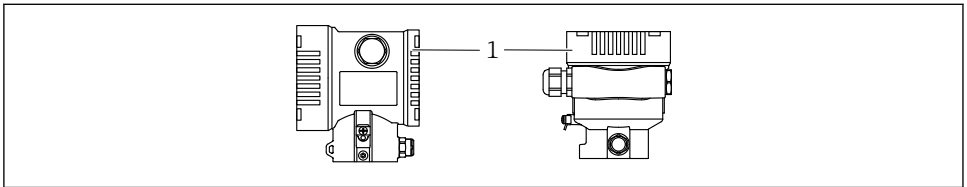

A0043806

- 1 Connection compartment cover



Housing thread

The thread of the electronics and connection compartment is coated with lubricant varnish.

- ⊗ Avoid additional lubrication.

6.2.1 Supply voltage

- Ex d, Ex e, non-Ex: supply voltage: 10.5 to 35 V_{DC}
- Ex i: supply voltage: 10.5 to 30 V_{DC}
- Nominal current: 4 to 20 mA HART



The power unit must be tested to ensure it meets safety requirements (e.g., PELV, SELV, Class 2) and must comply with the relevant protocol specifications. The requirements for 4 to 20 mA are the same as those for HART.

Depending on the supply voltage and the current consumption, background lighting is switched on or off. For the dependency, see the diagram:

Depending on the supply voltage and the current consumption, Bluetooth can optionally be switched on or off. For the dependency, see the diagram:

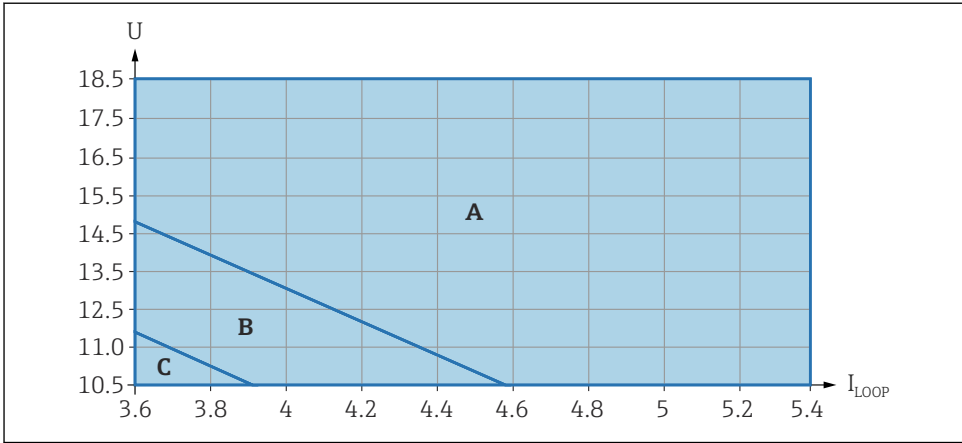

A0047056

- A *Display lighting switched on, Bluetooth can be switched on optionally*
- B *Display lighting switched off and Bluetooth can be switched on optionally*
- C *Display lighting switched off and Bluetooth not active*

6.2.2 Terminals

- Supply voltage and internal ground terminal: 0.5 to 2.5 mm² (20 to 14 AWG)
- External ground terminal: 0.5 to 4 mm² (20 to 12 AWG)

6.2.3 Cable specification

- Protective ground or grounding of the cable shield: rated cross-section > 1 mm² (17 AWG)
Rated cross-section of 0.5 mm² (20 AWG) to 2.5 mm² (13 AWG)
- Cable outer diameter: Ø5 to 12 mm (0.2 to 0.47 in) depends on the cable gland used (see Technical Information)

6.2.4 4-20 mA HART



A0028908

 1 Block diagram of HART connection

- 1 Device with HART communication
- 2 HART communication resistor
- 3 Power supply
- 4 Multimeter



The HART communication resistor of 250 Ω in the signal line is always necessary in the case of a low-impedance power supply.

Take the voltage drop into consideration:

Maximum 6 V with a communication resistor of 250 Ω

6.2.5 Overvoltage protection

Devices without optional overvoltage protection

Equipment from Endress+Hauser fulfills the requirements of the product standard IEC / DIN EN 61326-1 (Table 2 Industrial Environment).

Depending on the type of port (DC power supply, input/output port) different testing levels according to IEC / DIN EN 61326-1 against transient overvoltages (Surge) are applied (IEC / DIN EN 61000-4-5 Surge):

Test level on DC power ports and input / output ports is 1000 V line to earth

Devices with optional overvoltage protection

- Spark-over voltage: min. 400 V DC
- Tested according to IEC / DIN EN 60079-14 sub chapter 12.3 (IEC / DIN EN 60060-1 chapter 7)
- Nominal discharge current: 10 kA

Overvoltage category

Overvoltage category II

6.2.6 Wiring

WARNING

Supply voltage might be connected!

Risk of electric shock and/or explosion!

- ▶ If the device is used in hazardous areas, comply with national standards and the specifications in the Safety Instructions (XAs). Use the specified cable gland.
- ▶ The supply voltage must match the specifications on the nameplate.
- ▶ Switch off the supply voltage before connecting the device.
- ▶ If necessary, the potential matching line can be connected to the outer ground terminal of the transmitter before the device is connected.
- ▶ A suitable circuit breaker should be provided for the device in accordance with IEC/EN 61010.
- ▶ The cables must be adequately insulated, with due consideration given to the supply voltage and the overvoltage category.
- ▶ The connecting cables must offer adequate temperature stability, with due consideration given to the ambient temperature.
- ▶ Only operate the device with the covers closed.

Connect the device in the following order:

1. Release the cover lock (if provided).
2. Unscrew the cover.
3. Guide the cables into the cable glands or cable entries.
4. Connect the cable.
5. Tighten the cable glands or cable entries so that they are leak-tight. Counter-tighten the housing entry. Use a suitable tool with width across flats AF24/25 8 Nm (5.9 lbf ft) for the M20 cable gland.
6. Screw the cover securely back onto the connection compartment.
7. If fitted: tighten the screw of the cover lock using the Allen key 0.7 Nm (0.52 lbf ft) ± 0.2 Nm (0.15 lbf ft).

6.2.7 Terminal assignment

Single compartment housing

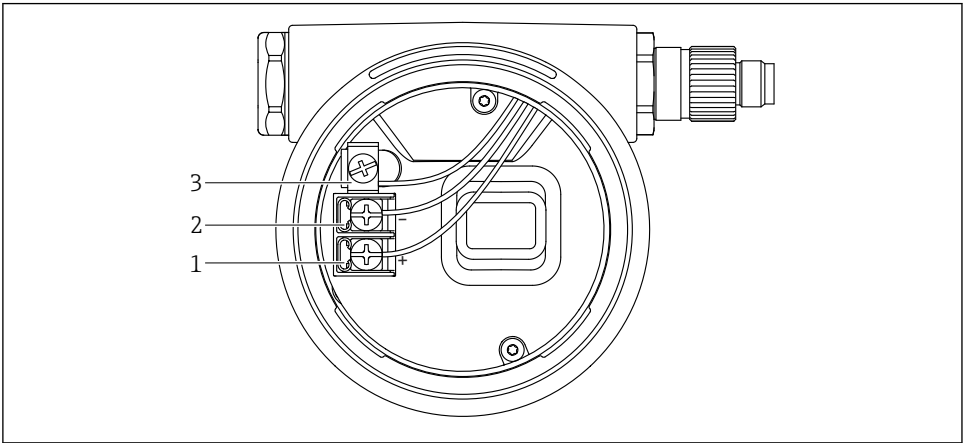

A0042594

2 Connection terminals and ground terminal in the connection compartment

1 Positive terminal

2 Negative terminal

3 Internal ground terminal

Dual compartment housing

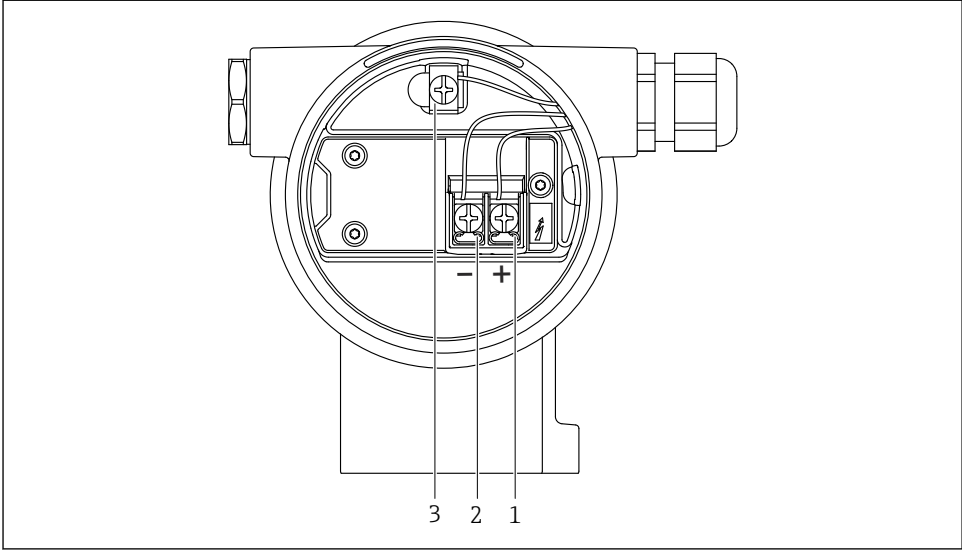

A0042803

3 Connection terminals and ground terminal in the connection compartment

- 1 Positive terminal
- 2 Negative terminal
- 3 Internal ground terminal

6.2.8 Cable entries

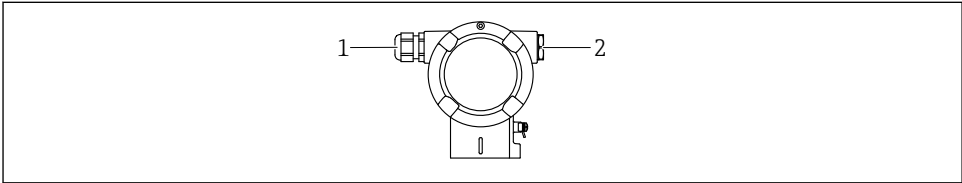

A0045414

- 1 Cable entry
- 2 Dummy plug

The type of cable entry depends on the device version ordered.

i Always route connecting cables downwards so that moisture cannot penetrate the connection compartment.

If necessary, create a drip loop or use a weather protection cover.

6.2.9 Available device plugs



In the case of devices with a plug, it is not necessary to open the housing for connection purposes.

Use the enclosed seals to prevent the penetration of moisture into the device.

Devices with a Harting plug Han7D

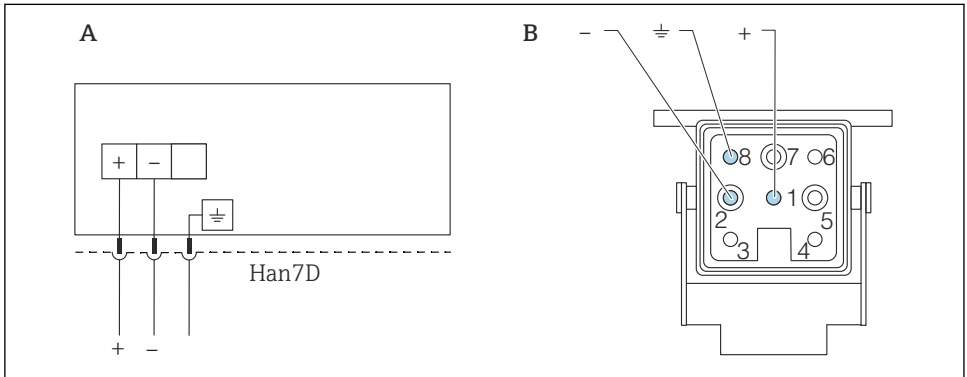

A0041011

A Electrical connection for devices with Harting plug Han7D

B View of the plug-in connection on the device

- Brown

≡ Green/yellow

+ Blue

6.3 Ensuring the degree of protection

6.3.1 Cable entries

- Gland M20, plastic, IP66/68 TYPE 4X/6P
- Gland M20, brass nickel plated, IP66/68 TYPE 4X/6P
- Gland M20, 316L, IP66/68 TYPE 4X/6P
- Thread M20, IP66/68 TYPE 4X/6P
- Thread G1/2, IP66/68 TYPE 4X/6P

If the G1/2 thread is selected, the device is delivered with an M20 thread as standard and a G1/2 adapter is included with the delivery, along with the corresponding documentation

- Thread NPT1/2, IP66/68 TYPE 4X/6P
- Dummy plug transport protection: IP22, TYPE 2
- HAN7D plug, 90 degrees, IP65 NEMA Type 4X
- M12 plug

When housing is closed and connecting cable is plugged in: IP66/67, NEMA Type 4X

When housing is open or connecting cable is not plugged in: IP20, NEMA Type 1

NOTICE**M12 plug and HAN7D plug: incorrect mounting can invalidate the IP protection class!**

- ▶ The degree of protection only applies if the connecting cable used is plugged in and screwed tight.
- ▶ The degree of protection only applies if the connecting cable used is specified according to IP67, NEMA Type 4X.
- ▶ The IP protection classes are only maintained if the dummy cap is used or the cable is connected.

7 Operation options

7.1 Operating keys and DIP switches on the electronic insert

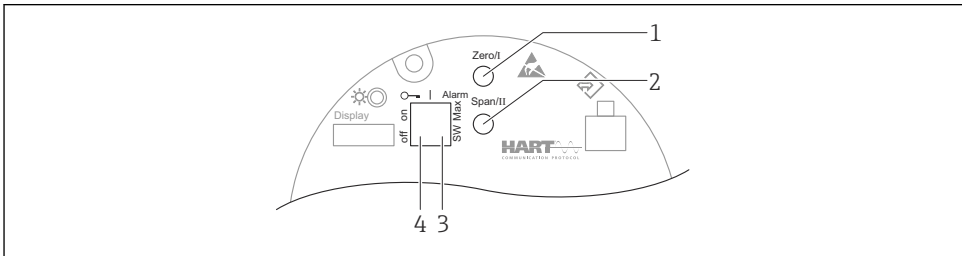

A0039285

- 1 Operating key for lower range value (Zero)
- 2 Operating key for upper range value (Span)
- 3 DIP switch for alarm current
- 4 DIP switch for locking and unlocking the device



The setting of the DIP switches has priority over the settings made via other operation methods (e.g. FieldCare/DeviceCare).

7.2 Access to the operating menu via the local display

7.2.1 Device display (optional)

Functions:

- Display of measured values and fault and notice messages
- Background lighting, which switches from green to red in the event of an error
- The device display can be removed for easier operation



The device displays are available with the additional option of Bluetooth® wireless technology.



Depending on the supply voltage and the current consumption, background lighting is switched on or off.

Depending on the supply voltage and the current consumption, Bluetooth can optionally be switched on or off.

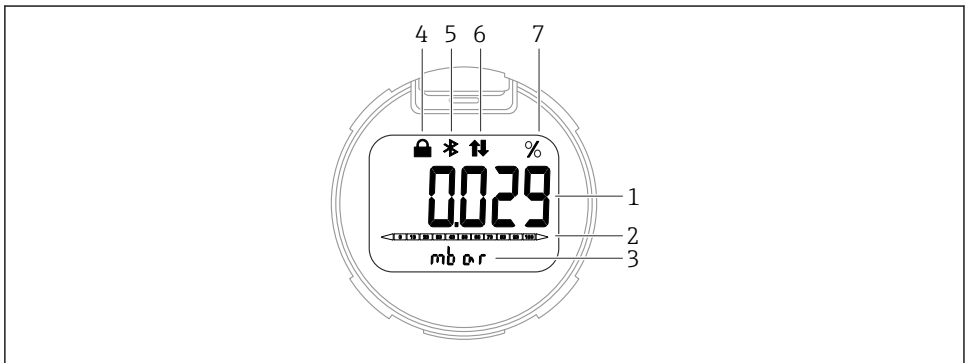

A0043599

4 Segment display

- 1 Measured value
- 2 Bar graph proportional to the current output
- 3 Unit of measured value
- 4 Locked (symbol appears when the device is locked)
- 5 Bluetooth (symbol flashes if Bluetooth connection is active)
- 6 HART communication (symbol is displayed if HART communication is active)
- 7 Measured value output in %

The following graphics are examples. The display depends on the display settings.

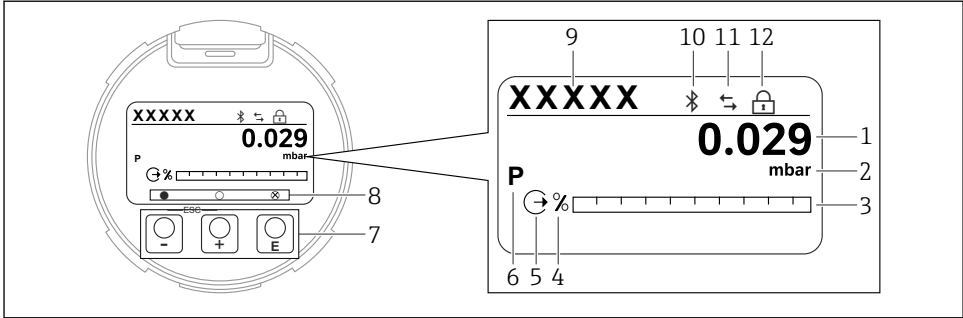

A0047142

5 Graphic display with optical operating keys.

- 1 Measured value
- 2 Unit of measured value
- 3 Bar graph proportional to the current output
- 4 Bar graph unit
- 5 Symbol for current output
- 6 Symbol for displayed measured value (e.g. p = pressure)
- 7 Optical operating keys
- 8 Symbols for key feedback. Different display symbols are possible: circle (not filled in) = key pressed briefly; circle (filled in) = key pressed for longer; circle (with X) = no operation possible due to Bluetooth connection
- 9 Device Tag
- 10 Bluetooth (symbol flashes if Bluetooth connection is active)
- 11 HART communication (symbol is displayed if HART communication is active)
- 12 Locked (symbol appears when the device is locked)

- **+** key
 - Navigate down in the picklist
 - Edit the numerical values or characters within a function
- **-** key
 - Navigate up in the picklist
 - Edit the numerical values or characters within a function
- **E** key
 - Confirm entry
 - Jump to the next item
 - Select a menu item and activate edit mode
 - Unlock/lock the display operation
 - Press and hold the **E** key to display a short description of the selected parameter (if available)
- **+** key and **-** key (ESC function)
 - Exit the edit mode for a parameter without saving the changed value
 - Menu at a selection level: pressing the keys simultaneously takes the user back up a level in the menu
 - Press and hold the keys simultaneously to return to the upper level

8 Commissioning

8.1 Preliminaries

The measuring range and the unit in which the measured value is transmitted correspond to the data on the nameplate.

WARNING

The settings of the current output are relevant for safety!

This situation can result in product overflow.

- ▶ The setting of the current output depends on the setting in the **Assign PV** parameter.
- ▶ After changing the **Assign PV** parameter, check the settings for the range (LRV and URV) and reconfigure them if necessary.

WARNING

Process pressure above or below permitted maximum/minimum!

Risk of injury if parts burst! Warnings are displayed if the pressure is too high.

- ▶ If a pressure smaller than the minimum permitted pressure or greater than the maximum permitted pressure is present at the device, a message is output.
- ▶ Only use the device within the measuring range limits!

8.1.1 As-delivered state

If no customized settings were ordered:

- **Assign PV** parameter **Pressure** option
- Calibration values defined by defined measuring cell nominal value
- The alarm current is set to min. (3.6 mA), (only if no other option was selected when ordering)
- DIP switch to Off position
- If Bluetooth is ordered, then Bluetooth is switched on

8.2 Function check

Perform a function check before putting the measuring point into operation:

- "Post-installation check" checklist (see the "Installation" section)
- "Post-connection check" checklist (see the "Electrical connection" section)

8.3 Switching on the device









All configuration tools offer a commissioning wizard that helps the user to configure the most important configuration parameters (**Guidance** menu **Commissioning** wizard).

8.4 Setting the operating language

8.4.1 Local display

Setting the operating language

 To set the operating language, the display first needs to be unlocked:

1. Press the  key for at least 2 s.
 - ↳ A dialog box appears.
2. Unlock the display operation.
3. Select the **Language** parameter in the main menu.
4. Press the  key.
5. Select the desired language with the  or  key.
6. Press the  key.

 Display operation locks automatically:

- after 1 min on the main page if no key has been pressed
- after 10 min within the operating menu if no key has been pressed

Display operation - locking or unlocking

The  key must be pressed for at least 2 seconds in order to lock or unlock the optical keys. Display operation can be locked or unlocked in the dialog that appears.

Display operation locks automatically (except in the SIL wizard):

- After 1 minute on the main page if no key has been pressed
- After 10 minutes within the operating menu if no key has been pressed

8.4.2 Operating tool

See the description of the operating tool.

8.5 Configuring the measuring device

8.5.1 Commissioning with keys on the electronic insert

The following functions are possible via the keys on the electronic insert:

- Position adjustment (zero point correction)
 - The orientation of the device may cause a pressure shift
 - This pressure shift can be corrected by a position adjustment
- Setting the lower range value and upper range value
 - The pressure applied must be within the nominal pressure limits of the sensor (see the specifications on the nameplate)
- Resetting the device

Carrying out position adjustment

1. Device installed in desired position and no pressure applied.

2. Press the "Zero" and "Span" keys simultaneously for at least 3 s.
3. When the LED lights up briefly, the pressure present has been accepted for position adjustment.

Setting the lower range value (pressure or scaled variable)

1. The desired pressure for the lower range value is present at the device.
2. Press the "Zero" key for at least 3 s.
3. When the LED lights up briefly, the pressure present has been accepted for the lower range value.

Setting the upper range value (pressure or scaled variable)

1. The desired pressure for the upper range value is present at the device.
2. Press the "Span" key for at least 3 s.
3. When the LED lights up briefly, the pressure present has been accepted for the upper range value.
4. Does the LED on the electronic insert not light up?
 - ↳ Applied pressure has not been accepted for upper range value.
Wet calibration is not possible if the **Scaled variable** option has been selected in the **Assign PV** parameter and the **Table** option has been selected in the **Scaled variable transfer function** parameter.

Checking the settings (pressure or scaled variable)

1. Press the "Zero" key briefly in order to display the lower range value.
2. Press the "Span" key briefly in order to display the upper range value.
3. Press the "Zero" and "Span" keys simultaneously in order to display the calibration offset.

Resetting the device

- ▶ Press and hold the "Zero" and "Span" keys simultaneously for at least 12 s.

8.5.2 Commissioning with the commissioning wizard

In FieldCare, DeviceCare ¹⁾, SmartBlue and on the display, the **Commissioning** wizard is available to guide the user through the initial commissioning steps. Commissioning is also possible via AMS or PDM.

1. Connect the device with FieldCare or DeviceCare.
2. Open the device in FieldCare or DeviceCare.
 - ↳ The dashboard (homepage) of the device is displayed:
3. In the **Guidance** menu, click the **Commissioning** wizard to open the wizard.

1) DeviceCare is available for download at www.software-products.endress.com. You must register in the Endress+Hauser software portal to download the product.

4. Enter the appropriate value in each parameter or select the appropriate option. These values are written directly to the device.
5. Click "Next" to go to the next page.
6. Once all the pages have been completed, click "End" to close the **Commissioning** wizard.

i If the **Commissioning** wizard is cancelled before all the necessary parameters have been configured, the device may be in an undefined state. In such situations, it is advisable to reset the device to the factory default settings.

Example: Outputting of the pressure value at the current output

i Pressure and temperature units are converted automatically. Other units are not converted.

In the following example, the pressure value should be measured in a tank and output on the current output. The maximum pressure of 450 mbar (6.75 psi) corresponds to the 20 mA current. The 4 mA current corresponds to a pressure of 50 mbar (0.75 psi).

Prerequisites:

- Measured variable in direct proportion to the pressure
- Due to the orientation of the device, there may be pressure shifts in the measured value (when the vessel is empty or partly filled, the measured value is not zero)
Perform a position adjustment if necessary
- In the **Assign PV** parameter, the **Pressure** option must be selected (factory setting)
Display: In the **Guidance** menu **Commissioning** wizard, keep pressing the \oplus key until you reach the **Assign PV** parameter. Press the \boxtimes key to confirm, select the **Pressure** option and press \boxtimes to confirm.

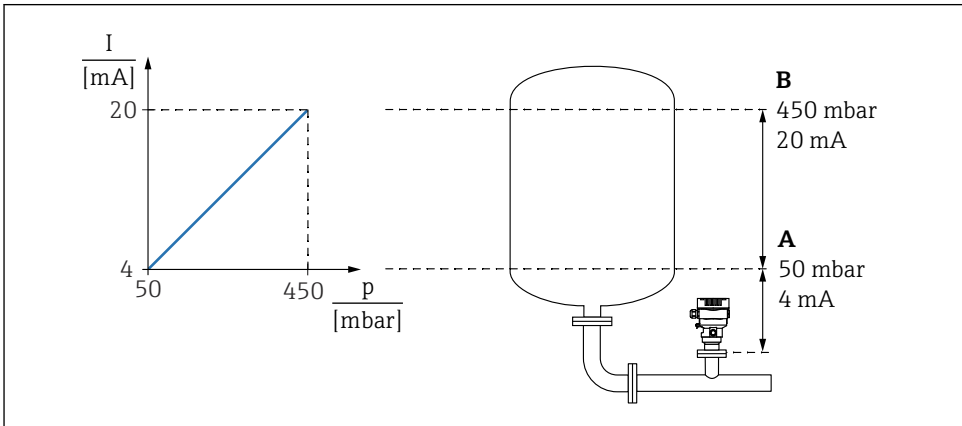

A0039009

- A Lower range value output
B Upper range value output

Adjustment:

1. Enter the pressure value for the 4 mA current via the **Lower range value output** parameter (50 mbar (0.75 psi)).
2. Enter the pressure value for the 20 mA current via the **Upper range value output** parameter (450 mbar (6.75 psi))

Result: The measuring range is set to 4 to 20 mA.

8.5.3 Commissioning without the commissioning wizard

Example: Commissioning a volume measurement in the tank

i Pressure and temperature units are converted automatically. Other units are not converted.

In the following example, the volume in a tank should be measured in liters. The maximum volume of 1 000 l (264 gal) corresponds to a pressure of 450 mbar (6.75 psi).

The minimum volume of 0 liters corresponds to a pressure of 50 mbar (0.75 psi).

Prerequisites:

- Measured variable in direct proportion to the pressure
- Due to the orientation of the device, there may be pressure shifts in the measured value (when the vessel is empty or partly filled, the measured value is not zero)
Perform position adjustment if necessary

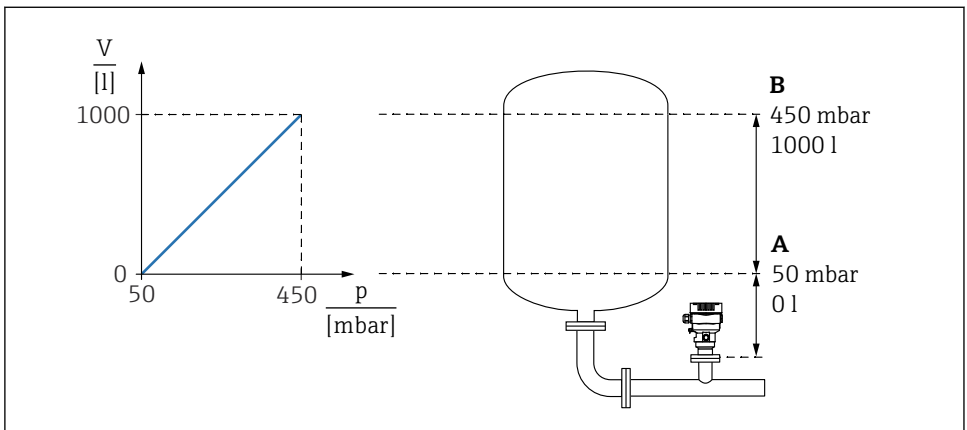

A0039010

A "Pressure value 1" parameter and "Scaled variable value 1" parameter

B "Pressure value 2" parameter and "Scaled variable value 2" parameter

i The pressure present is displayed in the operating tool on the same settings page in the "Pressure" field.

1. Enter the pressure value for the lower calibration point via the **Pressure value 1** parameter: 50 mbar (0.75 psi)
 - ↳ Menu path: Application → Sensor → Scaled variable → Pressure value 1
2. Enter the volume value for the lower calibration point via the **Scaled variable value 1** parameter: 0 l (0 gal)
 - ↳ Menu path: Application → Sensor → Scaled variable → Scaled variable value 1
3. Enter the pressure value for the upper calibration point via the **Pressure value 2** parameter: 450 mbar (6.75 psi)
 - ↳ Menu path: Application → Sensor → Scaled variable → Pressure value 2
4. Enter the volume value for the upper calibration point via the **Scaled variable value 2** parameter: 1 000 l (264 gal)
 - ↳ Menu path: Application → Sensor → Scaled variable → Scaled variable value 2

Result: The measuring range is set for 0 to 1 000 l (0 to 264 gal). Only the **Scaled variable value 1** parameter and **Scaled variable value 2** parameter are set with this setting. This setting has no effect on the current output.



71582828

www.addresses.endress.com
