

# Special Documentation

## **NMR8x, NMS8x, NRF8x**

# **Modbus Communication Protocol**

### Tank Gauging





## Table of contents

<b>1</b>	<b>Introduction</b> .....	<b>4</b>
<b>2</b>	<b>Configuration</b> .....	<b>5</b>
2.1	Modbus configuration .....	5
2.2	Communication .....	5
2.3	Supported MODBUS RTU function codes .....	6
2.4	Exception response .....	6
<b>3</b>	<b>Data mapping and format</b> .....	<b>7</b>
3.1	Data format .....	7
3.2	Data mapping .....	8
3.3	Error values .....	22
<b>4</b>	<b>Modbus telegram example</b> .....	<b>23</b>
<b>5</b>	<b>Modbus register assignment</b> .....	<b>24</b>
5.1	Platform Modbus map (recommended) .....	24
5.2	NMS5x map (compatibility) .....	31
5.3	NRF590 SW2.x map (compatibility) .....	34
5.4	NRF590 SW1.x map (compatibility) .....	36

# 1 Introduction

This protocol guide explains the operation of the MODBUS protocol per Modicon document PI-MBUS-300 Rev J implemented in the Endress+Hauser Tank Gauging Devices NRF81, NMR8x and NMS8x. The MODBUS protocol defines the data format and the techniques used to control the data flow. In MODBUS, the flow of data between two devices uses a master/slave type arrangement. Tank Gauging Devices act as a MODBUS slave and use the EIA (RS)-485 as a physical layer.

For details on the configuration and operation of the devices, refer to the Operating Instructions as specified in the following table.

Device	Operating Instructions
Micropilot NMR81	BA01450G
Micropilot NMR84	BA01453G
Proservo NMS80	BA01456G
Proservo NMS81	BA01459G
Proservo NMS83	BA01462G
Tankside Monitor NRF81	BA01465G

## 2 Configuration

### 2.1 Modbus configuration



Bold type marks the default settings.

Configuration item	Valid entries	Remarks
Modbus address	1 to 247	
Baud rate	<ul style="list-style-type: none"> <li>▪ 300</li> <li>▪ 1200</li> <li>▪ 2400</li> <li>▪ 4800</li> <li>▪ <b>9600</b></li> <li>▪ 19200</li> </ul>	Setup the baud rate for communication speed.
Parity	<ul style="list-style-type: none"> <li>▪ Odd</li> <li>▪ <b>Even</b></li> <li>▪ None/1 stop bit</li> <li>▪ None/2 stop bits</li> </ul>	
Float swap mode	<ul style="list-style-type: none"> <li>▪ Normal 3-2-1-0</li> <li>▪ <b>Swap 0-1-2-3</b></li> <li>▪ WWswap 1-0-3-2</li> </ul>	Set the format of the floating point value.
Bus termination	<ul style="list-style-type: none"> <li>▪ <b>Off</b></li> <li>▪ On</li> </ul>	Activate bus termination. Termination resistors should be placed at each end of the communication bus to minimize reflections on the line. If multiple devices are connected using MODBUS communication, then an adjustment must be made on the MODBUS communication board. For the last device connected on the MODBUS, the bus termination must be activated.
CRC seed	<ul style="list-style-type: none"> <li>▪ 0x0000</li> <li>▪ <b>0xFFFF</b></li> </ul>	This section sets the start value of the CRC register. The default value is 0xFFFF but some Modbus Masters work with 0x0000.
Invalid data	<ul style="list-style-type: none"> <li>▪ <b>0x00</b></li> <li>▪ 0xFF</li> </ul>	The data value that is filled in if an error occurred during data transfer.
Word type	<ul style="list-style-type: none"> <li>▪ Unsigned</li> <li>▪ Signed</li> </ul>	The floating point value must also be converted to an integer (unsigned or signed 16-bit) value, based on the 0% and 100% scaling factors for each input and the configuration of signed or unsigned.
Old TSMmode	<ul style="list-style-type: none"> <li>▪ Float values</li> <li>▪ Integer values</li> </ul>	The Old NRF590 SW1.x registers provide a float or integer values to the user → 36.
Compatibility mode	<ul style="list-style-type: none"> <li>▪ NMS5x</li> <li>▪ <b>NMS8x</b></li> </ul>	Affects content of registers <ul style="list-style-type: none"> <li>▪ Gauge status</li> <li>▪ Balance flag</li> <li>▪ Gauge command</li> </ul>

### 2.2 Communication

To establish communication with the Master device the MODBUS settings in the Tank Gauging device NMS, NRF and NMR have to match the settings of the master device. The configuration is described in the appropriate user manual of the device (see table above). The MODBUS address of the device provides unique identification for the host. The address is configurable in the range from 1 to 247 and must be unique for each MODBUS device on a loop. The Tank gauging devices only respond when a query has been sent to their unique address by the host. The MODBUS protocol defines two modes of transmission, Remote Terminal Unit (RTU) or ASCII (American Standard Code for Information Interchange). The choice between these two modes is dependent on the preference of the host. RTU is often the preferred protocol because of its improved error

detection capabilities and higher throughput. The ASCII mode uses ASCII printable characters to represent hexadecimal values, this mode of transmission requires almost twice as many characters to pass information compared with the RTU transmission mode.

 The Tank gauging devices Nxx8 only support the RTU mode of communication.

## 2.3 Supported MODBUS RTU function codes

The MODBUS functions implemented in the Tank Gauging Devices are listed in the following table.

Function code	Function code	Data type	MODBUS nomenclature
03	Read	Word, code, status word, floating point	Read holding registers
04	Read	Word, code, status word, floating point	Read input registers
06	Write	Word, code, status word	Preset single register
16	Write	Word, code, status word, floating point	Force multiple registers

## 2.4 Exception response

The exception responses returned by the Tank Gauging devices are listed below:

Exception	Response	Reason/Remedy measures
01	Illegal function	Try to use functions that are not supported.
02	Illegal data address	Data address (bit or register) is not defined.
03	Illegal data value.	Data value being written is out of range.
10	Value read only	Data address being written is read only.

## 3 Data mapping and format

The MODBUS data in the Tank gauging devices are arranged in word, floating point, timestamp, unit and and status bit registers. The assignment for these registers is found in →  24. Floating point data and timestamp data need two 16 bit registers for their data.

### 3.1 Data format

#### 3.1.1 Word registers

Word registers hold 16 bits of data. Following formats are used:

- Word Data (unsigned) - a scaled number from 0 to 65535
- Integer Data (signed) - a scaled number from -32768 to 32767
- Coded Data - multiple choice configuration data chosen from a coded list (→  8).
- Packed Bit Data - represent 16 individual status bits packed into one register.

#### 3.1.2 Floating point and timestamp data (two 16 bit registers)

Floating point numbers have been implemented using the IEEE 754 standard 32-bit representation.

The Nxx8 devices make these values available through a pair of 16-bit MODBUS registers. Function codes 03 or 04 are used to read a floating point register pair. Function code 16 is used to write floating point register pairs. The pair of registers holding the floating point MUST ALWAYS be read and written with a single command.

The timestamp needs also two 16 bit Modbus registers to represent year, month, day, hour, minutes and seconds. The detailed data format is described at →  14.

## 3.2 Data mapping

This chapter describes how coded data and packed bit data are represented in the word registers. Coded data respond to a look-up table value. Data written to these registers must be a valid table entry. Otherwise the value is rejected by an exception answer telegram. Packed bits represent up to 16 individual status bits packed into one register. The status bits have been packed this way for systems that prefer handling only register information. The bits within the packed registers are grouped by data or function type.

### 3.2.1 Gauge command

 Gauge command is only available in NMS8x devices. For all other devices this parameter will return zero.

Gauge command	Code [decimal]
Level	0
Up	1
Stop	2
Bottom level	3
Upper I/F level	4
Lower I/F level	5
Upper density	6
Middle density	7
Lower density	8
Repeatability	9
Water dip	10
Release overtension	11
Tank profile	12
Interface profile	13
Manual profile	14
Level standby	15
Offset standby	16



### 3.2.2 Gauge status

Depending on the **Protocol mode** parameter, the content of the **Gauge status** parameter is adjusted. In the **NMS5x mode**, only values which also existed in the NMS5x Gauge status are output to the bus. In the **NMS8x mode** all Gauge status values are available in this parameter.

 Gauge status is only available in NMS8x devices. For all other devices this parameter will return zero.

Gauge status of device	Protocol mode			
	NMS8x		NMS5x	
	Code [decimal]	NMS8x naming	Code [decimal]	NMS5x naming
Displacer at reference position	1	Displacer at reference position	1	Displacer at reference position
Displacer hoisting up	2	Displacer hoisting up	2	Displacer hoisting up
Displacer stop	4	Displacer stop	4	Displacer stop
Level measurement balanced	5	Level measurement balanced	5	Level measurement, balanced
Upper interface level balanced	6	Upper interface level balanced	6	Upp. I/F level, balanced
Lower Interface level balanced	7	Lower Interface level balanced	7	Midd. I/F level, balanced
Bottom measurement balanced	8	Bottom measurement balanced	8	Bottom meas. balanced
Upper density done	9	Upper density done	9	Upper Dens, finished
Middle density done	10	Middle density done	10	Middle Dens, finished
Lower density done	11	Lower density done	11	Bottom Dens, finished
Release overtension	12	Release overtension	12	Release over tension
Calibration activated	13	Calibration activated	13	Calibration activated
Seek level	14	Seek level	14	Seek level
Follow level	15	Follow level	15	Follow level
Seek upper interface level	19	Seek upper interface level	19	Seek Upper I/F level
Follow upper interface level	20	Follow upper interface level	20	Follow up. I/F level
Seek lower interface level	21	Seek lower interface level	21	Seek Mid. I/F level
Follow lower interface level	22	Follow lower interface level	22	Follow Mid. I/F level
Seek bottom level	23	Seek bottom level	23	Seek Bottom Level
Stopped at high stop	25	Stopped at high stop	25	Stopped at High Stop.
Stopped at low stop	26	Stopped at low stop	26	Stopped at Low Stop
Repeatability testing	27	Repeatability testing	27	Repeatability testing
Seek water level	28	Seek water level	28	Seek water level
Water dip finished	29	Water dip finished	29	Water level, balanced
Proof test done	32	Maintenance Mode	32	Maintenance Mode
Dip displacer	32	Maintenance Mode	32	Maintenance Mode
Verify weight	32	Maintenance Mode	32	Maintenance Mode
Verify dist	32	Maintenance Mode	32	Maintenance Mode
Start detector update	32	Maintenance Mode	32	Maintenance Mode
Detector update running	32	Maintenance Mode	32	Maintenance Mode
Verify updated detector software	32	Maintenance Mode	32	Maintenance Mode
Finish detector update	32	Maintenance Mode	32	Maintenance Mode
Startup	33	Startup	4	Displacer stop

Gauge status of device	Protocol mode			
	NMS8x		NMS5x	
	Code [decimal]	NMS8x naming	Code [decimal]	NMS5x naming
Check detector software version	33	Startup	4	Displacer stop
Water level error	34	Water level error	28	Seeking water level
Slow hoist up	35	Slow hoist up	2	Displacer hoisting up
Level found	36	Level found	15	Follow level
Bottom done	37	Bottom done	8	Bottom meas. balanced
Profile done	38	Profile done	9	Upper Dens, finished
Above liquid	39	Above liquid	27	Repeatability testing
Overtension released	40	Overtension released	12	Release over tension
Temporary balanced	41	Temporary balanced	5	Level measurement, balanced
Lower density error	42	Lower density error	11	Bottom Dens, finished
Middle density error	43	Middle density error	10	Middle Dens, finished
Profile error	44	Profile error	9	Upper Dens, finished
Upper density error	45	Upper density error	9	Upper Dens, finished
Wait for level	46	Wait for level	14	Seek level
Seek standby position	47	Seek standby position	14	Seek level
Move to target	48	Move to target	16	Seek Upper Density
Measure density	49	Measure density	16	Seek Upper Density
Measure in air	50	Measure in air	16	Seek Upper Density
Bottom error	51	Bottom error	23	Seek Bottom Lev

### 3.2.3 Balance flag

Depending on **Protocol mode** parameter, the contents of parameter **Balance flag** parameter is adjusted.

 Balance flag is only available in NMS8x devices. For all other devices this parameter will return zero.

Balance flag	Mode			
	NMS8x		NMS5x	
	Code [decimal]	NMS8x Name	Code [decimal]	NMS5x Name
Unbalanced	0	Unbalanced	0	OFF
Level balanced	1	Level balanced	1	ON
Upper IF balanced	2	Upper IF balanced	1	ON
Lower IF balanced	3	Lower IF balanced	1	ON
Bottom balanced	4	Bottom balanced	1	ON

### 3.2.4 One time command status

One time command status shows the status of non-continuous gauge commands (e.g. tank profile, water dip, etc).

 One time command status is only available in NMS8x devices. For all other devices this parameter will return zero.

One time command status	Code [decimal]
None (default)	0
In progress	2
Finished	3
Failed	4

### 3.2.5 Signal quality

Shows the quality of the evaluated level signal.

Signal quality	Code [decimal]
no signal	0
weak	1
medium	2
strong	3

 Signal quality is only available in NMR8x devices. For all other devices this parameter will return zero.

### 3.2.6 Discrete values

The table below shows how discrete values (e.g. Alarms) are coded.

State	Description
0	Unknown
1	Inactive

State	Description
2	Active
3	Invalid

### 3.2.7 Alarms



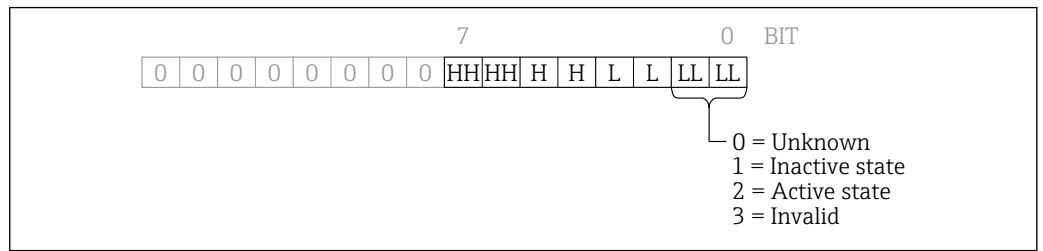

Alarms (Alarm 1...4) are coded into the modbus registers according to the following figure.



A003827

### 3.2.8 Status values

Status values are only available on NRF590 and new TGP map. All reserved bits are read as 0.

Bits	Value	Reset (0)	Set (1)	Home screen	Info
0	W&M Status	W&M invalid	W&M valid	 A0031169	W&M valid only if device is locked
1	reserved	/	/		
2	Error	No error	error	 A0012102	Status <b>Alarm</b> The measurement is interrupted. A diagnostic code is shown.
3...11	reserved	/	/		
12	Known or unknown	Unknown	known	 A0012103	Value has not been updated since startup.
13	reserved	0	1		
14	Warning	No warning	Warning	 A0012103	Status <b>Warning</b> The device continues measuring.
15	reserved	/	/		

If no errors/warnings are present this leads to the following Status value:

- Devices that are not W&M sealed: 4096<sub>dec</sub> (0x1000)
- Devices that are W&M sealed: 4097<sub>dec</sub> (0x1001)

### 3.2.9 Diagnostic information

The diagnostic information of the device is provided on the modbus register. All device diagnostic codes have a number between 0...999 and an additional preceding letter describing the kind of status. For the codes refer to the Operating Instructions of the device, chapter "Diagnostics and troubleshooting" (→  4). The preceding letter is coded according to below table and added to the diagnostic code:

Status Signal	Value
F	3000
C	2000
S	1000
M	0000

Example: F270 → 3270

### 3.2.10 Timestamp

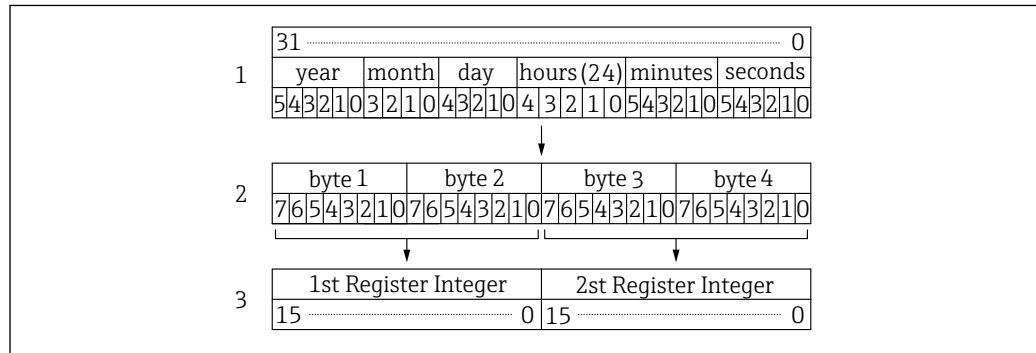

 1 Mapping of time and date to the two Modbus registers

To obtain the complete year, the value in the time stamp needs to be added to the system "Base Year".

### 3.2.11 Units

Units are coded using the HART standard. The highlighted units are supported by the tank parameters of the NMR8x, NMS8x or NRF8x. Other generic HART devices may provide any of these values.

HART unit code	Unit	Symbol
<b>Temperature</b>		
32	Degrees Celsius	°C
33	Degrees Fahrenheit	°F
34	Degrees Rankin	°R
35	Degrees Kelvin	Kelvin
<b>Pressure</b>		
1	Inches of Water (68°F)	InH <sub>2</sub> O
2	Inches of Mercury (0°C)	InHg
3	Feet of Water (68°F)	FtH <sub>2</sub> O
4	Millimeters of Water (68°F)	mmH <sub>2</sub> O
5	Millimeters of Mercury (0°C)	mmHg
6	Pounds per Square Inch	PSI
7	Bars	bar
8	Millibars	mbar
9	Grams per Square Centimeter	g/cm <sup>2</sup>
10	Kilograms per Square Centimeter	kg/cm <sup>2</sup>
11	Pascals	PA
12	Kilopascals	kPA
13	Torr	torr
14	Atmospheres	ATM
237	Megapascals	MPA
238	Inches of Water (4°C)	inH <sub>2</sub> O 4°C
239	Millimeters of Water (4°C)	mmH <sub>2</sub> O 4°C

HART unit code	Unit	Symbol
<b>Volumetric flow</b>		
15	Cubic Feet per Minute	ft <sup>3</sup> /min
16	Gallons per Minute (US)	gal/min
17	Liters per Minute	l/min
18	Imperial Galons per Minute	ImpGal/min
19	Cubic Meters per Hour	m <sup>3</sup> /hr
22	Gallons per Second (US)	gal/sec
23	Million Gallons per Day	MilGal/day
24	Liters per Second	lt/sec
25	Million Liters per Day	MilL/day
26	Cubic Feet per Second	ft <sup>3</sup> /sec
27	Cubic Feet per Day	ft <sup>3</sup> /day
28	Cubic Meters per Second	m <sup>3</sup> /sec
29	Cubic Meters per Day	m <sup>3</sup> /day
30	Imperial Gallons per Hour	ImpGal/hr
31	Imperial Gallons per Day	ImpGal/day
121	Normal Cubic Meters per Hour "MKS System"	m <sup>3</sup> /hr
122	Normal Liters per Hour "MKS System"	l/hr
123	Standard Cubic Feet per Minute "US System"	ft <sup>3</sup> /min
130	Cubic Feet per Hour	ft <sup>3</sup> /hr
131	Cubic Meters per Minute	m <sup>3</sup> /min
132	Barrels per Second (1 barrel = 42 US gallons)	bbl/s
133	Barrels per Minute (1 barrel = 42 US gallons)	bbl/min
134	Barrels per Hour (1 barrel = 42 US gallons)	bbl/hr
135	Barrels per Day (1 barrel = 42 US gallons)	bbl/day
136	Gallons per Hour (US)	gal/hr
137	Imperial Gallons per Second	ImpGal/s
138	Liters per Hour	l/hr
235	Gallons per Day (US)	gal/day
<b>Velocity</b>		
20	Feet per Second	ft/s
21	Meters per Second	mtr/s
114	Inches per Second	in/s
115	Inches per Minute	in/min
116	Feet per Minute	ft/min
120	Meters per Hour	mtr/hr



HART unit code	Unit	Symbol
<b>Volume</b>		
40	Gallon	gal
41	Liters	lt
42	Imperial Gallons	ImpGal
43	Cubic Meters	m <sup>3</sup>
46	Barrels (1 barrel = 42 US gallons)	bbl
110	Bushels	Bushels
111	Cubic Yards	yd <sup>3</sup>
112	Cubic Feet	ft <sup>3</sup>
113	Cubic Inches	in <sup>3</sup>
124	Liquid Barrel (= 31.5 US gallons)	bbLiq
166	Normal Cubic Meter "MKS System"	m <sup>3</sup>
167	Normal Liter "MKS System"	lt
168	Standard Cubic Feet "US System"	ft <sup>3</sup>
236	Hectoliters	hecto lt
<b>Length</b>		
<b>44</b>	<b>Feet</b>	<b>ft</b>
<b>45</b>	<b>Meters</b>	<b>m</b>
<b>47</b>	<b>Inches</b>	<b>in</b>
<b>48</b>	<b>Centimeters</b>	<b>cm</b>
<b>49</b>	<b>Millimeters</b>	<b>mm</b>
<b>Time</b>		
50	Minutes	min
51	SEconds	sec
52	Hours	hr
53	Days	day
<b>Mass</b>		
60	Grams	g
61	Kilograms	kg
62	Metric Tons	MetTon
63	Pounds	lb
64	Short Tons	ShTon
65	Long Ton	LTon
125	Ounce	Ounce

HART unit code	Unit	Symbol
<b>Mass flow</b>		
70	Grams per Second	g/s
71	Grams per Minute	g/min
72	Grams per Hour	g/hr
73	Kilograms per Second	kg/s
74	Kilograms per Minute	kg/min
75	Kilograms per Hour	kg/hr
76	Kilograms per Day	kg/day
77	Metric Tons per Minute	MetTon/min
78	Metric Tons per Hour	MetTon/hr
79	Metric Tons per Day	MetTon/day
80	Pounds per Second	lb/s
81	Pounds per Minute	lb/min
82	Pounds per Hour	lb/hr
83	Pounds per Day	lb/day
84	Short Tons per Minute	ShTon/min
85	Short Tons per Hour	ShTon/hr
86	Short Tons per Day	ShTon/day
87	Long Tons per Hour	LTon/hr
88	Long Tons per Day	LTon/day
<b>Mass per volume</b>		
90	<b>Specific Gravity Units</b>	<b>SGU</b>
91	<b>Grams per Cubic Centimeter</b>	<b>g/cm<sup>3</sup></b>
92	<b>Kilograms per Cubic Meter</b>	<b>kg/m<sup>3</sup></b>
93	<b>Pounds per Gallon (US)</b>	<b>lb/gal</b>
94	<b>Pounds per Cubic Feet</b>	<b>lb/ft<sup>3</sup></b>
95	<b>Grams per Milliliter</b>	<b>g/ml</b>
96	<b>Kilograms per Liter</b>	<b>kg/l</b>
97	<b>Grams per Liter</b>	<b>g/l</b>
98	<b>Pounds per Cubic inch</b>	<b>lb/in<sup>3</sup></b>
99	<b>Short Tons per Cubic Yard</b>	<b>ShTon/CuYd</b>
100	Degrees Twaddell	°Twad
102	Degrees Baume Heavy	°BaumHv
103	Degrees Baume Light	°BaumLt
104	<b>Degrees API</b>	<b>°API</b>
<b>Viscosity</b>		
54	Centistokes	centi stoke
55	Centipoise	cpoise
<b>Electromagnetic Unit of Electric Potential</b>		
36	Millivolts	mV
58	Volts	V
<b>Electrostatic Unit of Current</b>		
39	Milliamperes	mA

HART unit code	Unit	Symbol
<b>Electromagnetic Unit of Resistance</b>		
37	Ohms	Ohm
163	Kiloohms	kOhm
<b>Energy (includes Work)</b>		
69	Newton Meter	NM
89	Deka Therm	
126	Foot Pounds Force	
128	Kilo Watt Hour	kWh
164	Mega Joule	MJ
165	British Thermal Unit	BTU
162	Mega Calorie	MCal
<b>Power</b>		
127	Kilo Watt	kW
129	Horsepower	HP
140	Mega Calories per Hour	
141	Mega Joule per Hour	kWh
142	British Thermal Unit per Hour	BTU/hr
<b>Radial Velocity</b>		
117	Degrees per Second	deg/s
118	Revolutions per Second	rev/s
119	Revolutions per Minute	rpm
<b>Miscellaneous</b>		
38	Hertz	Hz
56	Microsiemens	μS
57	<b>Percent</b>	<b>%</b>
59	pH	pH
66	Milli Siemens per Centimeter	mSiemen/cm
67	Micro Siemens per Centimeter	μSiemen/cm
68	Newton	N
101	Degree Brix	°Brix
105	Percent Solids per Weight	%Sol/wt
106	Percent Solids per Volume	%Sol/vol
107	Degrees Balling	°Ball
108	Proof per Volume	proof/vol
109	Proof per Mass	proof/mass
139	Parts per Million	ppm
143	Degrees	°
150	Percent Steam Quality	%StmQual
151	Feet-Inch-1/16ths	ft-in-16
152	Cubic Feet per Pound	ft <sup>3</sup> /lb
153	Picofarads	pF
160	Percent Plato	%Plato

HART unit code	Unit	Symbol
<b>Special</b>		
250	Not Used	
251	No Units (Unitless Value)	
252 & 0	Unknown Units	
253	Special	
<b>Manufacturer specific definitions</b>		
240	1/16th Inch	1/16in
<b>241</b>	<b>Feet-Inch-1/16ths (stored as ft)</b>	<b>ft-in-16</b>
242	Meters per second per second	m/s <sup>2</sup>
<b>243</b>	<b>Feet-Inch-1/8ths (stoued as ft)</b>	<b>ft-in-8</b>
244	Cubic decimeter	dm <sup>3</sup>
245	Cubic decimeter	dm <sup>3</sup>
246		
247		
248		

### 3.2.12 Integer scaling

Scaling of a value is handled by a pair of parameters (**0% value** and **100% value**). Each type of measured value (Level, Temperature, Density, Pressure, etc) has its own set of scaling parameters due to the different value ranges each data type uses.

In most cases, 0% will have a value 0; here the integer value is simply calculated as follows:

$$\text{Integer} = \frac{\text{„Maximum Integer Value“}}{\text{„100% Value“}} \text{ Value}$$

A0033434-EN

In cases where 0% is not 0, the integer value is calculated as follows:

$$\text{Integer} = \frac{\text{„Maximum Integer Value“}}{\text{„100% Value“} - \text{„0% Value“}} (\text{Value} - \text{„0% Value“})$$

A0033435-EN

Here, **Maximum integer value** is:

- for unsigned integers: 65535
- for signed integers: 32767

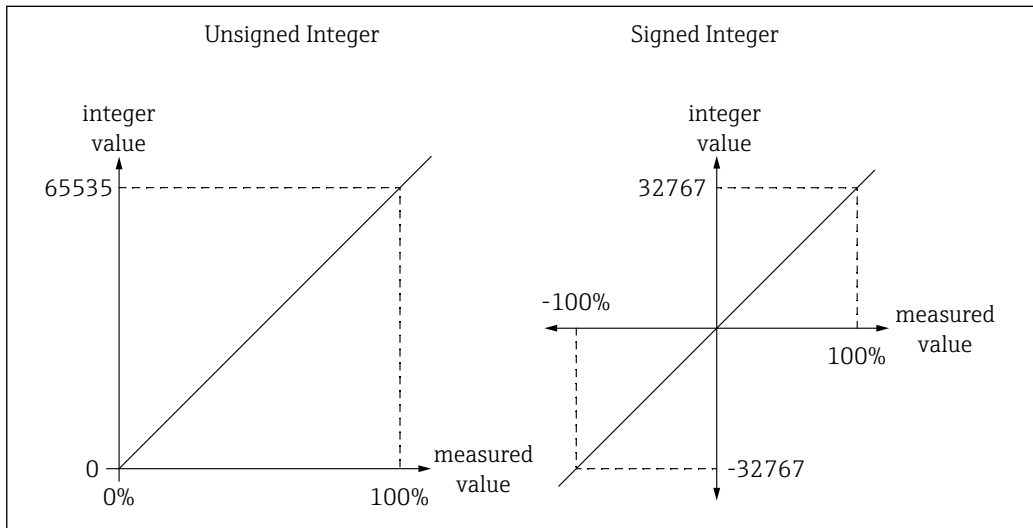



A0033437-EN

2 Integer scaling for unsigned and signed integers

### 3.3 Error values

If an input value has an error (e.g. due to a malfunction in the sensor), the measured value is indicated with a **bad** status. The status is shown on the Modbus output in different ways:

- Error status on the related status register of the affected value(s) →  13
- Diagnostic information →  14
- Setting of the measured value to its maximum. See table below:

System Unit	Modbus Float	Modbus Unsigned Integer	Modbus Signed Integer
Meters	≥ 99.999 m	65535	32767
Millimeters	≥ 99999.9 mm	65535	32767
Feet	≥ 999.99 ft	65535	32767
Celsius	≥ 999.9 °C	65535	32767
Percent	≥ 999.9 %	65535	32767
Inch	≥ 99999.9 in	65535	32767
ft-16-in, ft-8-in	≥ 999.9 ft	65535	32767
Centimeters	≥ 999.9 cm	65535	32767

## 4 Modbus telegram example

Reading the tank level (207.8818mm) as a float value:

Device ID	Function	Adress	Number of requests	CRC
0x01	0x04	0x15FA	0x0002	0x55F6

A0033825

3 Master → Slave request

Device ID	Function	Byte count	value	CRC
0x01	0x04	0x04	0x434FE1BE	0x17F7

A0033826

4 Slave → Master response

## 5 Modbus register assignment

The Tank gauging devices Nxx8 support different Modbus maps for compatibility reasons with old devices. Below figure provides an overview:

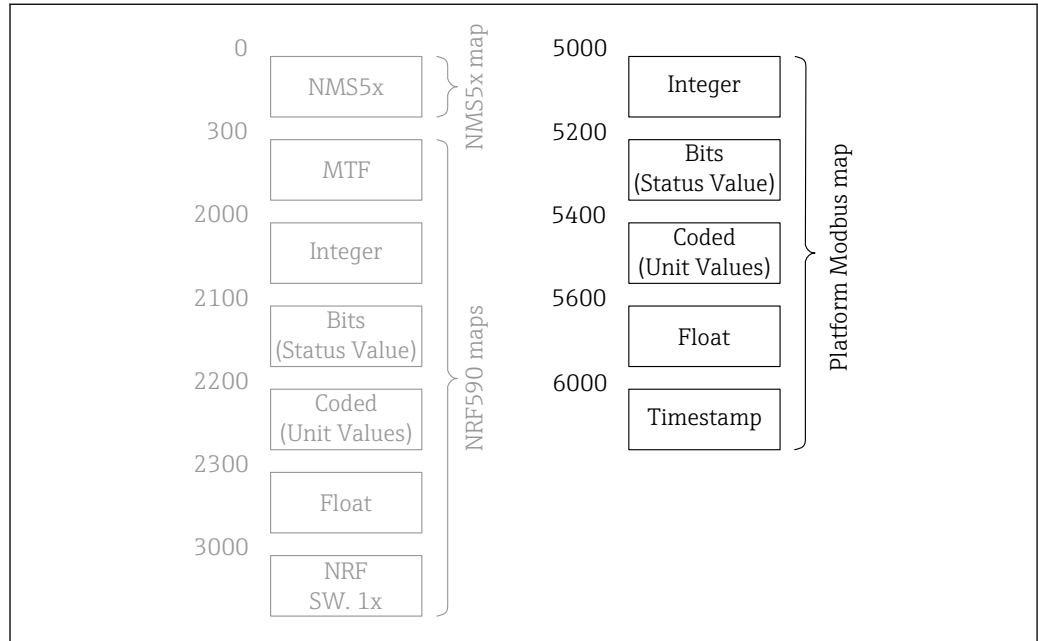

A0033436-EN

- i** For new implementations it is strongly recommended to use the Platform Modbus map (starting @5000) since this map provides the full functionality.
- On the Platform Modbus map the same parameter is available in different data formats (integer and float) with additional information (status, unit, timestamp). The scaling of integer values can be set in the device for each unit.
- For compatibility, the maps of NMS5 and NRF590 devices have also been implemented. However, these maps do not support the full functionality of the new Tank Gauging devices.

### 5.1 Platform Modbus map (recommended)

Parameter Name	Access	Device			Unit	Integer	Status	Unit	IEEE32 Float		Timestamp	
		NMS	NMR	NRF		Data Addr	Data Addr	Data Addr	Data Addr #1	Data Addr #2	Data Addr #1	Data Addr #2
User value 8	r	x	x	x	Customer Unit	5000	5200	5400	5600	5601	6000	6001
User value 7	r	x	x	x	Customer Unit	5001	5201	5401	5602	5603	6002	6003
User value 6	r	x	x	x	Customer Unit	5002	5202	5402	5604	5605	6004	6005
User value 5	r	x	x	x	Customer Unit	5003	5203	5403	5606	5607	6006	6007
User value 4	r	x	x	x	Customer Unit	5004	5204	5404	5608	5609	6008	6009
User value 3	r	x	x	x	Customer Unit	5005	5205	5405	5610	5611	6010	6011
User value 2	r	x	x	x	Customer Unit	5006	5206	5406	5612	5613	6012	6013
User value 1	r	x	x	x	Customer Unit	5007	5207	5407	5614	5615	6014	6015
One-time command status	r	x			no unit	5008	-	-	-	-	-	-
Gauge command	r w	x			no unit	5009	-	-	-	-	-	-
Gauge status	r	x			no unit	5010	-	-	-	-	-	-



Parameter Name	Access	Device			Unit	Integer	Status	Unit	IEEE32 Float		Timestamp	
		NMS	NMR	NRF		Data Addr	Data Addr	Data Addr	Data Addr #1	Data Addr #2	Data Addr #1	Data Addr #2
Balance flag	r	x			no unit	5011	-	-	-	-	-	-
Displacer position	r	x			Customer Unit	5012	5212	5412	5624	5625	6024	6025
Tank level	r	x	x	x	Customer Unit	5013	5213	5413	5626	5627	6026	6027
Liquid temperature	r	x	x	x	Customer Unit	5014	5214	5414	5628	5629	6028	6029
Water level	r	x	x	x	Customer Unit	5015	5215	5415	5630	5631	6030	6031
Observed density	r	x	x	x	Customer Unit	5016	5216	5416	5632	5633	6032	6033
P1 (bottom)	r	x	x	x	Customer Unit	5017	5217	5417	5634	5635	6034	6035
P2 (middle)	r	x	x	x	Customer Unit	5018	5218	5418	5636	5637	6036	6037
P3 (top)	r	x	x	x	Customer Unit	5019	5219	5419	5638	5639	6038	6039
Vapor temperature	r	x	x	x	Customer Unit	5020	5220	5420	5640	5641	6040	6041
Actual diagnostics	r	x	x	x	no unit	5021	-	-	-	-	-	-
Filtered distance	r		x		Customer Unit	5022	5222	5422	5644	5645	6044	6045
Signal quality	r		x		no unit	5023	-	-	-	-	-	-
Air temperature	r	x	x	x	Customer Unit	5024	5224	5424	5648	5649	6048	6049
Tank level %	r	x	x	x	Customer Unit	5025	5225	5425	5650	5651	6050	6051
Measured level	r	x	x	x	Customer Unit	5026	5226	5426	5652	5653	6052	6053
Bottom level	r	x			Customer Unit	5027	5227	5427	5654	5655	6054	6055
Upper interface level	r	x	x	x	Customer Unit	5028	5228	5428	5656	5657	6056	6057
Lower interface level	r	x	x	x	Customer Unit	5029	5229	5429	5658	5659	6058	6059
Measured upper density	r	x	x	x	Customer Unit	5030	5230	5430	5660	5561	6060	6061
Measured middle density	r	x	x	x	Customer Unit	5031	5231	5431	5662	5663	6062	6063
Measured lower density	r	x	x	x	Customer Unit	5032	5232	5432	5664	5665	6064	6065
Upper density	r	x			Customer Unit	5033	5233	5433	5666	5667	6066	6067
Middle density	r	x			Customer Unit	5034	5234	5434	5668	5669	6068	6069
Lower density	r	x			Customer Unit	5035	5235	5435	5670	5671	6070	6071
Upper density offset	r	x			Customer Unit	5036	5236	5436	5672	5673	6072	6073
Middle density offset	r	x			Customer Unit	5037	5237	5437	5674	5675	6074	6075
Lower density offset	r	x			Customer Unit	5038	5238	5438	5676	5677	6076	6077
Element temperature 1	r	x	x	x	Customer Unit	5039	5239	5439	5678	5679	6078	6079
Element temperature 2	r	x	x	x	Customer Unit	5040	5240	5440	5680	5681	6080	6081
Element temperature 3	r	x	x	x	Customer Unit	5041	5241	5441	5682	5683	6082	6083
Element temperature 4	r	x	x	x	Customer Unit	5042	5242	5442	5684	5685	6084	6085
Element temperature 5	r	x	x	x	Customer Unit	5043	5243	5443	5686	5687	6086	6087
Element temperature 6	r	x	x	x	Customer Unit	5044	5244	5444	5688	5689	6088	6089
Element temperature 7	r	x	x	x	Customer Unit	5045	5245	5445	5690	5691	6090	6091
Element temperature 8	r	x	x	x	Customer Unit	5046	5246	5446	5692	5693	6092	6093
Element temperature 9	r	x	x	x	Customer Unit	5047	5247	5447	5694	5695	6094	6095
Element temperature 10	r	x	x	x	Customer Unit	5048	5248	5448	5696	5697	6096	6097

Parameter Name	Access	Device			Unit	Integer	Status	Unit	IEEE32 Float		Timestamp	
		NMS	NMR	NRF		Data Addr	Data Addr	Data Addr	Data Addr #1	Data Addr #2	Data Addr #1	Data Addr #2
Element temperature 11	r	x	x	x	Customer Unit	5049	5249	5449	5698	5699	6098	6099
Element temperature 12	r	x	x	x	Customer Unit	5050	5250	5450	5700	5701	6100	6101
Element temperature 13	r	x	x	x	Customer Unit	5051	5251	5451	5702	5703	6102	6103
Element temperature 14	r	x	x	x	Customer Unit	5052	5252	5452	5704	5705	6104	6105
Element temperature 15	r	x	x	x	Customer Unit	5053	5253	5453	5706	5707	6106	6107
Element temperature 16	r	x	x	x	Customer Unit	5054	5254	5454	5708	5709	6108	6109
Element temperature 17	r	x	x	x	Customer Unit	5055	5255	5455	5710	5711	6110	6111
Element temperature 18	r	x	x	x	Customer Unit	5056	5256	5456	5712	5713	6112	6113
Element temperature 19	r	x	x	x	Customer Unit	5057	5257	5457	5714	5715	6114	6115
Element temperature 20	r	x	x	x	Customer Unit	5058	5258	5458	5716	5717	6116	6117
Element temperature 21	r	x	x	x	Customer Unit	5059	5259	5459	5718	5719	6118	6119
Element temperature 22	r	x	x	x	Customer Unit	5060	5260	5460	5720	5721	6120	6121
Element temperature 23	r	x	x	x	Customer Unit	5061	5261	5461	5722	5723	6122	6123
Element temperature 24	r	x	x	x	Customer Unit	5062	5262	5462	5724	5725	6124	6125
Profile density 1	r	x			Customer Unit	5063	5263	5463	5726	5727	6126	6127
Profile density 2	r	x			Customer Unit	5064	5264	5464	5728	5729	6128	6129
Profile density 3	r	x			Customer Unit	5065	5265	5465	5730	5731	6130	6131
Profile density 4	r	x			Customer Unit	5066	5266	5466	5732	5733	6132	6133
Profile density 5	r	x			Customer Unit	5067	5267	5467	5734	5735	6134	6135
Profile density 6	r	x			Customer Unit	5068	5268	5468	5736	5737	6136	6137
Profile density 7	r	x			Customer Unit	5069	5269	5469	5738	5739	6138	6139
Profile density 8	r	x			Customer Unit	5070	5270	5470	5740	5741	6140	6141
Profile density 9	r	x			Customer Unit	5071	5271	5471	5742	5743	6142	6143
Profile density 10	r	x			Customer Unit	5072	5272	5472	5744	5745	6144	6145
Profile density 11	r	x			Customer Unit	5073	5273	5473	5746	5747	6146	6147
Profile density 12	r	x			Customer Unit	5074	5274	5474	5748	5749	6148	6149
Profile density 13	r	x			Customer Unit	5075	5275	5475	5750	5751	6150	6151
Profile density 14	r	x			Customer Unit	5076	5276	5476	5752	5753	6152	6153
Profile density 15	r	x			Customer Unit	5077	5277	5477	5754	5755	6154	6155
Profile density 16	r	x			Customer Unit	5078	5278	5478	5756	5757	6156	6157
Profile density 17	r	x			Customer Unit	5079	5279	5479	5758	5759	6158	6159
Profile density 18	r	x			Customer Unit	5080	5280	5480	5760	5761	6160	6161

Parameter Name	Access	Device			Unit	Integer	Status	Unit	IEEE32 Float		Timestamp	
		NMS	NMR	NRF		Data Addr	Data Addr	Data Addr	Data Addr #1	Data Addr #2	Data Addr #1	Data Addr #2
Profile density 19	r	x			Customer Unit	5081	5281	5481	5762	5763	6162	6163
Profile density 20	r	x			Customer Unit	5082	5282	5482	5764	5765	6164	6165
Profile density 21	r	x			Customer Unit	5083	5283	5483	5766	5767	6166	6167
Profile density 22	r	x			Customer Unit	5084	5284	5484	5768	5769	6168	6169
Profile density 23	r	x			Customer Unit	5085	5285	5485	5770	5771	6170	6171
Profile density 24	r	x			Customer Unit	5086	5286	5486	5772	5773	6172	6173
Profile density 25	r	x			Customer Unit	5087	5287	5487	5774	5775	6174	6175
Profile density 26	r	x			Customer Unit	5088	5288	5488	5776	5777	6176	6177
Profile density 27	r	x			Customer Unit	5089	5289	5489	5778	5779	6178	6179
Profile density 28	r	x			Customer Unit	5090	5290	5490	5780	5781	6180	6181
Profile density 29	r	x			Customer Unit	5091	5291	5491	5782	5783	6182	6183
Profile density 30	r	x			Customer Unit	5092	5292	5492	5784	5785	6184	6185
Profile density 31	r	x			Customer Unit	5093	5293	5493	5786	5787	6186	6187
Profile density 32	r	x			Customer Unit	5094	5294	5494	5788	5789	6188	6189
Profile density 33	r	x			Customer Unit	5095	5295	5495	5790	5791	6190	6191
Profile density 34	r	x			Customer Unit	5096	5296	5496	5792	5793	6192	6193
Profile density 35	r	x			Customer Unit	5097	5297	5497	5794	5795	6194	6195
Profile density 36	r	x			Customer Unit	5098	5298	5498	5796	5797	6196	6197
Profile density 37	r	x			Customer Unit	5099	5299	5499	5798	5799	6198	6199
Profile density 38	r	x			Customer Unit	5100	5300	5500	5800	5801	6200	6201
Profile density 39	r	x			Customer Unit	5101	5301	5501	5802	5803	6202	6203
Profile density 40	r	x			Customer Unit	5102	5302	5502	5804	5805	6204	6205
Profile density 41	r	x			Customer Unit	5103	5303	5503	5806	5807	6206	6207
Profile density 42	r	x			Customer Unit	5104	5304	5504	5808	5809	6208	6209
Profile density 43	r	x			Customer Unit	5105	5305	5505	5810	5811	6210	6211
Profile density 44	r	x			Customer Unit	5106	5306	5506	5812	5813	6212	6213
Profile density 45	r	x			Customer Unit	5107	5307	5507	5814	5815	6214	6215
Profile density 46	r	x			Customer Unit	5108	5308	5508	5816	5817	6216	6217
Profile density 47	r	x			Customer Unit	5109	5309	5509	5818	5819	6218	6219
Profile density 48	r	x			Customer Unit	5110	5310	5510	5820	5821	6220	6221
Profile density 49	r	x			Customer Unit	5111	5311	5511	5822	5823	6222	6223
Profile density 50	r	x			Customer Unit	5112	5312	5512	5824	5825	6224	6225
Profile density position 1	r	x			Customer Unit	5113	5313	5513	5826	5827	6226	6227
Profile density position 2	r	x			Customer Unit	5114	5314	5514	5828	5829	6228	6229
Profile density position 3	r	x			Customer Unit	5115	5315	5515	5830	5831	6230	6231
Profile density position 4	r	x			Customer Unit	5116	5316	5516	5832	5833	6232	6233
Profile density position 5	r	x			Customer Unit	5117	5317	5517	5834	5835	6234	6235

Parameter Name	Access	Device			Unit	Integer	Status	Unit	IEEE32 Float		Timestamp	
		NMS	NMR	NRF		Data Addr	Data Addr	Data Addr	Data Addr #1	Data Addr #2	Data Addr #1	Data Addr #2
Profile density position 6	r	x			Customer Unit	5118	5318	5518	5836	5837	6236	6237
Profile density position 7	r	x			Customer Unit	5119	5319	5519	5838	5839	6238	6239
Profile density position 8	r	x			Customer Unit	5120	5320	5520	5840	5841	6240	6241
Profile density position 9	r	x			Customer Unit	5121	5321	5521	5842	5843	6242	6243
Profile density position 10	r	x			Customer Unit	5122	5322	5522	5844	5845	6244	6245
Profile density position 11	r	x			Customer Unit	5123	5323	5523	5846	5847	6246	6247
Profile density position 12	r	x			Customer Unit	5124	5324	5524	5848	5849	6248	6249
Profile density position 13	r	x			Customer Unit	5125	5325	5525	5850	5851	6250	6251
Profile density position 14	r	x			Customer Unit	5126	5326	5526	5852	5853	6252	6253
Profile density position 15	r	x			Customer Unit	5127	5327	5527	5854	5855	6254	6255
Profile density position 16	r	x			Customer Unit	5128	5328	5528	5856	5857	6256	6257
Profile density position 17	r	x			Customer Unit	5129	5329	5529	5858	5859	6258	6259
Profile density position 18	r	x			Customer Unit	5130	5330	5530	5860	5861	6260	6261
Profile density position 19	r	x			Customer Unit	5131	5331	5531	5862	5863	6262	6263
Profile density position 20	r	x			Customer Unit	5132	5332	5532	5864	5865	6264	6265
Profile density position 21	r	x			Customer Unit	5133	5333	5533	5866	5867	6266	6267
Profile density position 22	r	x			Customer Unit	5134	5334	5534	5868	5869	6268	6269
Profile density position 23	r	x			Customer Unit	5135	5335	5535	5870	5871	6270	6271
Profile density position 24	r	x			Customer Unit	5136	5336	5536	5872	5873	6272	6273
Profile density position 25	r	x			Customer Unit	5137	5337	5537	5874	5875	6274	6275
Profile density position 26	r	x			Customer Unit	5138	5338	5538	5876	5877	6276	6277
Profile density position 27	r	x			Customer Unit	5139	5339	5539	5878	5879	6278	6279
Profile density position 28	r	x			Customer Unit	5140	5340	5540	5880	5881	6280	6281
Profile density position 29	r	x			Customer Unit	5141	5341	5541	5882	5883	6282	6283
Profile density position 30	r	x			Customer Unit	5142	5342	5542	5884	5885	6284	6285

Parameter Name	Access	Device			Unit	Integer	Status	Unit	IEEE32 Float		Timestamp	
		NMS	NMR	NRF		Data Addr	Data Addr	Data Addr	Data Addr #1	Data Addr #2	Data Addr #1	Data Addr #2
Profile density position 31	r	x			Customer Unit	5143	5343	5543	5886	5887	6286	6287
Profile density position 32	r	x			Customer Unit	5144	5344	5544	5888	5889	6288	6289
Profile density position 33	r	x			Customer Unit	5145	5345	5545	5890	5891	6290	6291
Profile density position 34	r	x			Customer Unit	5146	5346	5546	5892	5893	6292	6293
Profile density position 35	r	x			Customer Unit	5147	5347	5547	5894	5895	6294	6295
Profile density position 36	r	x			Customer Unit	5148	5348	5548	5896	5897	6296	6297
Profile density position 37	r	x			Customer Unit	5149	5349	5549	5898	5899	6298	6299
Profile density position 38	r	x			Customer Unit	5150	5350	5550	5900	5901	6300	6301
Profile density position 39	r	x			Customer Unit	5151	5351	5551	5902	5903	6302	6303
Profile density position 40	r	x			Customer Unit	5152	5352	5552	5904	5905	6304	6305
Profile density position 41	r	x			Customer Unit	5153	5353	5553	5906	5907	6306	6307
Profile density position 42	r	x			Customer Unit	5154	5354	5554	5908	5909	6308	6309
Profile density position 43	r	x			Customer Unit	5155	5355	5555	5910	5911	6310	6311
Profile density position 44	r	x			Customer Unit	5156	5356	5556	5912	5913	6312	6313
Profile density position 45	r	x			Customer Unit	5157	5357	5557	5914	5915	6314	6315
Profile density position 46	r	x			Customer Unit	5158	5358	5558	5916	5917	6316	6317
Profile density position 47	r	x			Customer Unit	5159	5359	5559	5918	5919	6318	6319
Profile density position 48	r	x			Customer Unit	5160	5360	5560	5920	5921	6320	6321
Profile density position 49	r	x			Customer Unit	5161	5361	5561	5922	5923	6322	6323
Profile density position 50	r	x			Customer Unit	5162	5362	5562	5924	5925	6324	6325
Tank ullage	r	x	x	x	Customer Unit	5163	5363	5563	5926	5927	6326	6327
Alarm 1	r	x	x	x	Customer Unit	5164	-	-	-	-	-	-
Alarm 2	r	x	x	x	Customer Unit	5165	-	-	-	-	-	-
Alarm 3	r	x	x	x	Customer Unit	5166	-	-	-	-	-	-
Alarm 4	r	x	x	x	Customer Unit	5167	-	-	-	-	-	-
Discrete 1	r	x	x	x	Customer Unit	5168	-	-	-	-	-	-
Discrete 2	r	x	x	x	Customer Unit	5169	-	-	-	-	-	-
Discrete 3	r	x	x	x	Customer Unit	5170	-	-	-	-	-	-
Discrete 4	r	x	x	x	Customer Unit	5171	-	-	-	-	-	-

Parameter Name	Access	Device			Unit	Integer	Status	Unit	IEEE32 Float		Timestamp	
		NMS	NMR	NRF		Data Addr	Data Addr	Data Addr	Data Addr #1	Data Addr #2	Data Addr #1	Data Addr #2
Discrete 5	r	x	x	x	Customer Unit	5172	-	-	-	-	-	-
Discrete 6	r	x	x	x	Customer Unit	5173	-	-	-	-	-	-
Discrete 7	r	x	x	x	Customer Unit	5174	-	-	-	-	-	-
Discrete 8	r	x	x	x	Customer Unit	5175	-	-	-	-	-	-
Base year	r	x	x	x	no unit	5999	-	-	-	-	-	-
Observed Density Temperature	r	x	x	x	Customer Unit	-	-	-	5990	5991	-	-

## 5.2 NMS5x map (compatibility)



- This map is not recommended for new implementations.
- On this map the units as well as scaling of integer values is fixed and not configurable.

Data address	Parameter name	Data range	Unit	Data type	Scaling	Access
0	Displacer position	/	mm	FLOAT	/	r
2	Tank level	/	mm	FLOAT	/	r
4	Liquid temperature	-200.0 to 360.0	°C	INTEGER	*10+1	r
5	Air temperature	-200.0 to 360.0	°C	INTEGER	*10+1	r
6	not available	0	/	FLOAT	/	r
8	not available	0	/	FLOAT	/	r
10	Water level	/	mm	FLOAT	/	r
12	Upper density	0 to 3.2767	g/ml	WORD	*10+3	r
13	Middle density	0 to 3.2767	g/ml	WORD	*10+3	r
14	Lower density	0 to 3.2767	g/ml	WORD	*10+3	r
15	Upper interface level	/	mm	FLOAT	/	r
17	Lower interface level	/	mm	FLOAT	/	r
19	Bottom level	/	mm	FLOAT	/	r
21	Gauge status	0 to 31	/	WORD	/	r
22	Balance flag	0 to 1	/	WORD	/	r
23	Actual diagnostics	0 to 999	/	WORD	/	r
24	Level alarm	0 to 3	/	WORD	/	r
25	not available	/	/	WORD	/	r
26	Gauge command	0 to 15		WORD	/	r/w
27	not available	0	/	WORD	/	r
28	not available	/	/	WORD	/	/
29	Element temperature 1	-200.0 to 360.0	°C	INTEGER	*10+1	r
30	Element temperature 2	-200.0 to 360.0	°C	INTEGER	*10+1	r
31	Element temperature 3	-200.0 to 360.0	°C	INTEGER	*10+1	r
32	Element temperature 4	-200.0 to 360.0	°C	INTEGER	*10+1	r
33	Element temperature 5	-200.0 to 360.0	°C	INTEGER	*10+1	r
34	Element temperature 6	-200.0 to 360.0	°C	INTEGER	*10+1	r
35	Element temperature 7	-200.0 to 360.0	°C	INTEGER	*10+1	r
36	Element temperature 8	-200.0 to 360.0	°C	INTEGER	*10+1	r
37	Element temperature 9	-200.0 to 360.0	°C	INTEGER	*10+1	r
38	Element temperature 10	-200.0 to 360.0	°C	INTEGER	*10+1	r
39	Element temperature 11	-200.0 to 360.0	°C	INTEGER	*10+1	r
40	Element temperature 12	-200.0 to 360.0	°C	INTEGER	*10+1	r
41	Element temperature 13	-200.0 to 360.0	°C	INTEGER	*10+1	r
42	Element temperature 14	-200.0 to 360.0	°C	INTEGER	*10+1	r
43	Element temperature 15	-200.0 to 360.0	°C	INTEGER	*10+1	r
44	Element temperature 16	-200.0 to 360.0	°C	INTEGER	*10+1	r
45	not available	0	/	WORD	/	r

Data address	Parameter name	Data range	Unit	Data type	Scaling	Access
46	not available	0	/	WORD	/	r
47	not available	0	/	WORD	/	r
48	not available	0	/	WORD	/	r
49	not available	0	/	WORD	/	r
50	not available	0	/	WORD	/	r
51	not available	0	/	WORD	/	r
52	not available	0	/	WORD	/	r
53	not available	0	/	WORD	/	r
54	not available	0	/	WORD	/	r
55	not available	0	/	WORD	/	r
56	not available	0	/	WORD	/	r
57	not available	0	/	WORD	/	r
58	not available	0	/	WORD	/	r
59	not available	0	/	WORD	/	r
60	not available	0	/	WORD	/	r
61	One-time command status	0 to 5	/	WORD	/	r
62	not available	0	/	WORD		r
63	Time stamp profile (day)	00 to 31	/	WORD		r
64	Time stamp profile (time)	0 to 2 459	/	WORD		r
65	Upper interface level	0 to 65 535	mm	WORD		r
66	Observed density	0 to 3.2767	g/ml	WORD	*10+3	r
67	Liquid temperature	-200.0 to 360.0	°C	INTEGER	*10+1	r
68	Profile density 1	0 to 3.2767	g/ml	WORD	*10+3	r
69	Profile density 2	0 to 3.2767	g/ml	WORD	*10+3	r
70	Profile density 3	0 to 3.2767	g/ml	WORD	*10+3	r
71	Profile density 4	0 to 3.2767	g/ml	WORD	*10+3	r
72	Profile density 5	0 to 3.2767	g/ml	WORD	*10+3	r
73	Profile density 6	0 to 3.2767	g/ml	WORD	*10+3	r
74	Profile density 7	0 to 3.2767	g/ml	WORD	*10+3	r
75	Profile density 8	0 to 3.2767	g/ml	WORD	*10+3	r
76	Profile density 9	0 to 3.2767	g/ml	WORD	*10+3	r
77	Profile density 10	0 to 3.2767	g/ml	WORD	*10+3	r
78	Profile density 11	0 to 3.2767	g/ml	WORD	*10+3	r
79	Profile density 12	0 to 3.2767	g/ml	WORD	*10+3	r
80	Profile density 13	0 to 3.2767	g/ml	WORD	*10+3	r
81	Profile density 14	0 to 3.2767	g/ml	WORD	*10+3	r
82	Profile density 15	0 to 3.2767	g/ml	WORD	*10+3	r
83	Profile density 16	0 to 3.2767	g/ml	WORD	*10+3	r
84	Profile density position 1	0 to 65 535	mm	WORD		r
85	Profile density position 2	0 to 65 535	mm	WORD		r
86	Profile density position 3	0 to 65 535	mm	WORD		r
87	Profile density position 4	0 to 65 535	mm	WORD		r
88	Profile density position 5	0 to 65 535	mm	WORD		r



Data address	Parameter name	Data range	Unit	Data type	Scaling	Access
89	Profile density position 6	0 to 65 535	mm	WORD		r
90	Profile density position 7	0 to 65 535	mm	WORD		r
91	Profile density position 8	0 to 65 535	mm	WORD		r
92	Profile density position 9	0 to 65 535	mm	WORD		r
93	Profile density position 10	0 to 65 535	mm	WORD		r
94	Profile density position 11	0 to 65 535	mm	WORD		r
95	Profile density position 12	0 to 65 535	mm	WORD		r
96	Profile density position 13	0 to 65 535	mm	WORD		r
97	Profile density position 14	0 to 65 535	mm	WORD		r
98	Profile density position 15	0 to 65 535	mm	WORD		r
99	Profile density position 16	0 to 65 535	mm	WORD		r

### 5.3 NRF590 SW2.x map (compatibility)

 This map is not recommended for new implementations.

Parameter Name	Access	Unit	Integer	Status	Unit	IEEE32 Float	
			Data Address	Data Address	Data Address	Data Address #1	Data Address #2
User value 8	r	Customer Unit	2000	2100	2200	2300	2301
User value 7	r	Customer Unit	2001	2101	2201	2302	2303
User value 6	r	Customer Unit	2002	2102	2202	2304	2305
User value 5	r	Customer Unit	2003	2103	2203	2306	2307
User value 4	r	Customer Unit	2004	2104	2204	2308	2309
User value 3	r	Customer Unit	2005	2105	2205	2310	2311
User value 2	r	Customer Unit	2006	2106	2206	2312	2313
User value 1	r	Customer Unit	2007	2107	2207	2314	2315
Tank level	r	Customer Unit	2009	2109	2209	2318	2319
Liquid temperature	r	Customer Unit	2010	2110	2210	2320	2321
Vapour temperature	r	Customer Unit	2011	2111	2211	2322	2323
Water level	r	Customer Unit	2012	2112	2212	2324	2325
Observed density	r	Customer Unit	2013	2113	2213	2326	2327
P1 (bottom)	r	Customer Unit	2014	2114	2214	2328	2329
P2 (middle)	r	Customer Unit	2015	2115	2215	2330	2331
P3 (top)	r	Customer Unit	2016	2116	2216	2332	2333
GP value 1	r	Customer Unit	2017	2117	2217	2334	2335
GP value 2	r	Customer Unit	2018	2118	2218	2336	2337
GP value 3	r	Customer Unit	2019	2119	2219	2338	2339
GP value 4	r	Customer Unit	2020	2120	2220	2340	2341
Measured level	r	Customer Unit	2021	2121	2221	2342	2343
Tank level %	r	Customer Unit	2022	2122	2222	2344	2345
Level flow	r	Customer Unit	2023	2123	2223	2346	2347
Volume flow	r	Customer Unit	2024	2124	2224	2348	2349
reserved	r	Customer Unit	2025	2125	2225	2350	2351
Element temperature 1	r	Customer Unit	2026	2126	2226	2352	2353
Element temperature 2	r	Customer Unit	2027	2127	2227	2354	2355
Element temperature 3	r	Customer Unit	2028	2128	2228	2356	2357
Element temperature 4	r	Customer Unit	2029	2129	2229	2358	2359
Element temperature 5	r	Customer Unit	2030	2130	2230	2360	2361
Element temperature 6	r	Customer Unit	2031	2131	2231	2362	2363
Element temperature 7	r	Customer Unit	2032	2132	2232	2364	2365
Element temperature 8	r	Customer Unit	2033	2133	2233	2366	2367
Element temperature 9	r	Customer Unit	2034	2134	2234	2368	2369
Element temperature 10	r	Customer Unit	2035	2135	2235	2370	2371
Element temperature 11	r	Customer Unit	2036	2136	2236	2372	2373
Element temperature 12	r	Customer Unit	2037	2137	2237	2374	2375
Element temperature 13	r	Customer Unit	2038	2138	2238	2376	2377

Parameter Name	Access	Unit	Integer	Status	Unit	IEEE32 Float	
			Data Address	Data Address	Data Address	Data Address #1	Data Address #2
Element temperature 14	r	Customer Unit	2039	2139	2239	2378	2379
Element temperature 15	r	Customer Unit	2040	2140	2240	2380	2381
Element temperature 16	r	Customer Unit	2041	2141	2241	2382	2383
Discrete 1	r	Customer Unit	2042	-	-	-	-
Discrete 2	r	Customer Unit	2043	-	-	-	-
Discrete 3	r	Customer Unit	2044	-	-	-	-
Discrete 4	r	Customer Unit	2045	-	-	-	-
Discrete 5	r	Customer Unit	2046	-	-	-	-
Discrete 6	r	Customer Unit	2047	-	-	-	-
Discrete 7	r	Customer Unit	2048	-	-	-	-
Discrete 8	r	Customer Unit	2049	-	-	-	-
Measured upper density	r	Customer Unit	2050	2150	2250	2400	2401
Measured middle density	r	Customer Unit	2051	2151	2251	2402	2403
Measured lower density	r	Customer Unit	2052	2152	2252	2404	2405
not available	r	Customer Unit	2053	2153	2253	2406	2407
Tank reference height	r	Customer Unit	2054	2154	2254	2408	2409
not available	r	Customer Unit	2055	2155	2255	2410	2411
Element temperature 17	r	Customer Unit	2056	2156	2256	2412	2413
Element temperature 18	r	Customer Unit	2057	2157	2257	2414	2415
Element temperature 19	r	Customer Unit	2058	2158	2258	2416	2417
Element temperature 20	r	Customer Unit	2059	2159	2259	2418	2419
Element temperature 21	r	Customer Unit	2060	2160	2260	2420	2421
Element temperature 22	r	Customer Unit	2061	2161	2261	2422	2423
Element temperature 23	r	Customer Unit	2062	2162	2262	2424	2425
Air temperature	r	Customer Unit	2063	2163	2263	2426	2427
Volume	r	Customer Unit	2064	2164	2264	2428	2429
reserved	r	Customer Unit	2065	2165	2265	2430	2431
Modbus discrete 1	r/w	Customer Unit	2090	-	-	-	-
Modbus discrete 2	r/w	Customer Unit	2091	-	-	-	-
Modbus discrete 3	r/w	Customer Unit	2092	-	-	-	-
Modbus discrete 4	r/w	Customer Unit	2093	-	-	-	-
Modbus value 1	r/w	Customer Unit	-	2190	2290	2490	2491
Modbus value 2	r/w	Customer Unit	-	2191	2291	2492	2493
Modbus value 3	r/w	Customer Unit	-	2192	2292	2494	2495
Modbus value 4	r/w	Customer Unit	-	2193	2293	2496	2497
Gauge status	r	no unit	2500	-	-	-	-
Gauge command	r/w	no unit	2501	-	-	-	-

## 5.4 NRF590 SW1.x map (compatibility)



- This map is not recommended for new implementations.
- This map is affected by the parameter OldTSMmode were it can be chosen if all parameters are
  - floating point values
  - converted into integer values using the same scaling factors.

Parameter name	Access	Data address	Data type
Measured level	r	3000	Float or Integer
Measured level	r	3002	Float or Integer
Product Temp	r	3004	Float or Integer
P1 (bottom)	r	3006	Float or Integer
P2 (middle)	r	3008	Float or Integer
P3 (top)	r	3010	Float or Integer
Observed density	r	3012	Float or Integer
Water level	r	3014	Float or Integer
Vapour temperature	r	3016	Float or Integer
Point status <ul style="list-style-type: none"> <li>▪ Bit#0: Invalid Level</li> <li>▪ Bit#1: Invalid Liquid Temp</li> <li>▪ Bit#2: Invalid Water Level</li> <li>▪ Bit#3: Invalid Observed Density</li> <li>▪ Bit#4: Invalid P3</li> <li>▪ Bit#5: Invalid P2</li> <li>▪ Bit#6: Invalid P1</li> <li>▪ Bit#7: Invalid Standard Density</li> <li>▪ Bit#8: Reserved</li> <li>▪ Bit#9: Level below minimum</li> <li>▪ Bit#10: Reserved</li> <li>▪ Bit#11: Reserved</li> <li>▪ Bit#12: Reserved</li> <li>▪ Bit#13: Invalid Air Temp</li> <li>▪ Bit#14: Invalid Vapor Temp</li> <li>▪ Bit#15: Invalid Flow</li> </ul>	r	3018	Integer
Product Temp	r	3030	Float or Integer
Vapour temperature	r	3032	Float or Integer
Vapour temperature	r	3034	Float or Integer
Element temperature 1	r	3036	Float or Integer
Element temperature 2	r	3038	Float or Integer
Element temperature 3	r	3040	Float or Integer
Element temperature 4	r	3042	Float or Integer
Element temperature 5	r	3044	Float or Integer
Element temperature 6	r	3046	Float or Integer
Element temperature 7	r	3048	Float or Integer
Element temperature 8	r	3050	Float or Integer
Element temperature 9	r	3052	Float or Integer
Element temperature 10	r	3054	Float or Integer
Element temperature 11	r	3056	Float or Integer
Element temperature 12	r	3058	Float or Integer
Element temperature 13	r	3060	Float or Integer
Element temperature 14	r	3062	Float or Integer

Parameter name	Access	Data address	Data type
Element temperature 15	r	3064	Float or Integer
Element temperature 16	r	3066	Float or Integer
Analog point status	r	3114	Integer (Always zero)
WM Lock	r	3115	Integer
WM Status	r	3176	Integer
Product Level	r	3179	Integer (Unit)
Product Temp	r	3180	Integer (Unit)
P1	r	3181	Integer (Unit)
Observed density	r	3182	Integer (Unit)
Tank reference height	r	3193	Float or Integer
Product Level	r	3195	Float or Integer







71582747

[www.addresses.endress.com](http://www.addresses.endress.com)

---