

Operating Instructions

Rxn-20 Raman spectroscopic probe



Table of Contents

1 About this document.....	4	6 Installation	16
1.1 Warnings.....	4	6.1 Hazardous area installation.....	17
1.2 Symbols on the device.....	4	6.2 Process and probe head compatibility	17
1.3 U.S. export compliance	4	6.3 Certifications and markings.....	18
1.4 Glossary	5	7 Commissioning.....	19
2 Basic safety instruction	6	7.1 Receipt of probe	19
2.1 Requirements for personnel	6	7.2 Probe calibration and verification.....	19
2.2 Designated use	6	8 Operation	20
2.3 Workplace safety.....	6	8.1 Silica Raman removal	20
2.4 Operational safety.....	6	8.2 Focusing excitation radiation	20
2.5 Laser safety	7	9 Diagnostics and troubleshooting.....	21
2.6 Service safety	7	10 Maintenance.....	22
2.7 Important safeguards	7	10.1 Cleaning the lens/window	22
2.8 Product safety.....	8	10.2 Inspecting and cleaning the optical fibers	22
3 Product description	10	11 Repair	23
3.1 The Rxn-20 probe	10	12 Technical data	24
3.2 Benefits of the probe head design.....	10	12.1 General specifications	24
3.3 Raman Rxn-20 probe accessories.....	11	12.2 Maximum permissible exposure	24
4 Incoming product acceptance and product identification	13	12.3 Nominal hazard zone	26
4.1 Incoming acceptance.....	13	13 Supplementary documentation	27
4.2 Product identification	13	14 Index.....	28
4.3 Scope of delivery.....	13		
4.4 Certificates and approvals.....	14		
5 Probe head and fiber optic connection	15		

1 About this document

1.1 Warnings



Structure of Information	Meaning
 WARNING Causes (/consequences) If necessary, consequences of non-compliance (if applicable) ▶ Corrective action	This symbol alerts you to a dangerous situation. Failure to avoid the dangerous situation can result in a fatal or serious injury.
 CAUTION Causes (/consequences) If necessary, consequences of non-compliance (if applicable) ▶ Corrective action	This symbol alerts you to a dangerous situation. Failure to avoid this situation can result in minor or more serious injuries.
 NOTICE Cause/situation If necessary, consequences of non-compliance (if applicable) ▶ Action/note	This symbol alerts you to situations which may result in damage to property.

Table 1. Warnings

1.2 Symbols on the device





Symbol	Description
	The Laser Radiation symbol is used to alert the user to the danger of exposure to hazardous visible laser radiation when using the Raman Rxn system.
	The High Voltage symbol that alerts people to the presence of electric potential large enough to cause injury or damage. In certain industries, high voltage refers to voltage above a certain threshold. Equipment and conductors that carry high voltage warrant special safety requirements and procedures.
	The CSA Certification Mark indicates that the product was tested against and met the applicable North American standards requirements.
	The WEEE symbol indicates that the product should not be discarded as unsorted waste but must be sent to separate collection facilities for recovery and recycling.
	The CE Marking indicates conformity with health, safety, and environmental protection standards for products sold within the European Economic Area (EEA).

Table 2. Symbols

1.3 U.S. export compliance

The policy of Endress+Hauser is strict compliance with U.S. export control laws as detailed in the website of the [Bureau of Industry and Security](#) at the U.S. Department of Commerce.

1.4 Glossary

Term	Description
ANSI	American National Standards Institute
ATEX	atmosphere explosible
°C	Celsius
CDRH	Center for Devices and Radiological Health
CFR	Code of Federal Regulations
cm	centimeter
CSA	Canadian Standards Association
EU	European Union
EXC	excitation
°F	Fahrenheit
FC	fiber channel
ft.	feet
GMP	good manufacturing practices
IEC	International Electrotechnical Commission
in.	inches
lbs.	pounds
m	meter
mm	millimeter
MPE	maximum permissible exposure
MT	mechanical transfer
nm	nanometer
NOHD	nominal ocular hazard distance
PAT	process analytical technology
PTFE	polytetrafluoroethylene (Teflon)
WEEE	Waste Electrical and Electronic Equipment

Table 3. Glossary

2 Basic safety instruction

2.1 Requirements for personnel

- Installation, commissioning, operation, and maintenance of the measuring system may be carried out only by specially trained technical personnel.
- The technical personnel must be authorized by the plant operator to carry out the specified activities.
- The technical personnel must have read and understood these Operating Instructions and must follow the instructions contained herein.
- The facility must designate a laser safety officer who ensures staff are trained on all Class 3B laser operating and safety procedures.
- Faults at the measuring point may only be rectified by properly authorized and trained personnel. Repairs not described in this document must be carried out only directly at the manufacturer's site or by the service organization.

2.2 Designated use

The Rxn-20 Raman spectroscopic probe is intended for the measurement of solids and semi-solids in a laboratory or process development or manufacturing setting.

Recommended applications include:

- **Polymers:** extruded pellet quality, crystallinity, density, raw materials
- **Pharmaceutical:** crystallinity, polymorphism, granulation, blend uniformity, content uniformity, coating, tableting
- **Chemicals:** final product quality, blend impurities, crystallinity, raw materials
- **Food and beverage:** quality of dairy solids, meat and fish composition

Use of the device for any purpose other than that described, poses a threat to the safety of people and of the entire measuring system and invalidates any warranty.

2.3 Workplace safety

As the user, you are responsible for complying with the following safety conditions:

- Installation guidelines
- Local standards and regulations for electromagnetic compatibility

The product has been tested for electromagnetic compatibility in accordance with the applicable international standards for industrial applications.

The electromagnetic compatibility indicated applies only to a product that has been properly connected to the analyzer.

2.4 Operational safety

Before commissioning the entire measuring point:

1. Verify that all connections are correct.
2. Ensure that electro-optical cables are undamaged.
3. Do not operate damaged products, and protect them against unintentional operation.
4. Label damaged products as defective.

During operation:

1. If faults cannot be rectified, products must be taken out of service and protected against unintentional operation.
2. When working with laser devices, always follow all local laser safety protocols which may include the use of personal protective equipment and limiting device access to authorized users.

2.5 Laser safety

The Raman Rxn analyzers use Class 3B lasers as defined in the following:

- [American National Standards Institute](#) (ANSI) Z136.1, American National Standard for Safe Use of Lasers
- [International Electrotechnical Commission](#) (IEC) 60825-1, Safety of Laser Products – Part 1

⚠ WARNING

Laser radiation

- ▶ Avoid exposure to beam
- ▶ Class 3B laser product

⚠ CAUTION

Laser beams can cause ignition of certain substances such as volatile organic compounds.

The two possible mechanisms for ignition are direct heating of the sample to a point causing ignition and the heating of a contaminant (such as dusts) to a critical point leading to ignition of the sample.

The laser configuration presents further safety concerns because the radiation is nearly invisible. Always be aware of the initial direction and possible scattering paths of the laser. The use of laser safety glasses with OD3 or greater is highly recommended for 532 nm and 785 nm excitation wavelengths and OD4 or greater for a 993 nm excitation wavelength.

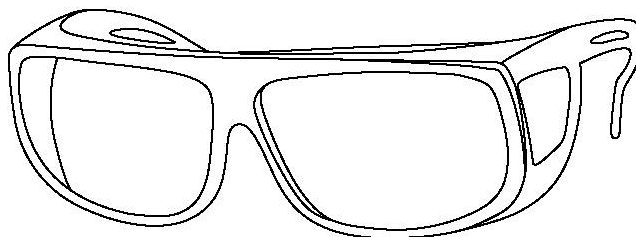

A0048421

Figure 1. Laser safety glasses

For more assistance with taking appropriate precautions and setting the proper controls when dealing with lasers and their hazards, refer to the most current version of ANSI Z136.1 or IEC 60825-14. See Section 12 →  of this document for relevant parameters to enable calculation of nominal ocular hazard distance (NOHD) and maximum permissible exposure (MPE).

2.6 Service safety

Follow your company's safety instructions when removing a process probe from the process interface for service. Always wear proper protective equipment when servicing the equipment.

2.7 Important safeguards

- Do not use the Rxn-20 probe for anything other than its intended use.
- Do not look directly into the laser beam.
- Do not point the laser at a mirrored/shiny surface or a surface that may cause diffuse reflections. The reflected beam is as harmful as the direct beam.
- Do not leave attached and unused probe heads uncapped or unblocked.
- Always use a laser beam block to avoid inadvertent scatter of laser radiation.
- Always secure the probe head so that it is pointing away from personnel. Never handle the probe head freely when it is operating.

2.8 Product safety

This product is designed to meet all current safety requirements, has been tested, and shipped from the factory in a safe operating condition. The relevant regulations and international standards have been observed. Devices connected to an analyzer must also comply with the applicable analyzer safety standards.

Endress+Hauser Raman spectroscopy systems incorporate the following safety features to conform to the United States Government requirements 21 [Code of Federal Regulations](#) (CFR) Chapter 1, Subchapter J as administered by the [Center for Devices and Radiological Health](#) (CDRH) and IEC 60825-1 as administered by the [International Electrotechnical Commission](#).

2.8.1 CDRH and IEC compliance

Endress+Hauser Raman analyzers are certified by Endress+Hauser to meet CDRH and IEC 60825-1 design and manufacturing requirements.

Endress+Hauser Raman analyzers have been registered with the CDRH. Any unauthorized modifications to an existing Raman Rxn2 or Raman Rxn4 analyzer or accessory may result in hazardous radiation exposure. Such modifications may result in the system being no longer in conformance with federal requirements as certified by Endress+Hauser.

2.8.2 Laser safety interlock

The Rxn-20 probe, as installed, forms part of the interlock circuit. If the fiber cable is severed, the laser will turn off within milliseconds of the breakage.

NOTICE

Handle probes and cables with care.

Fiber cables should NOT be kinked and should be routed to maintain the minimum bend radius of 75 mm (2.96 in.).

- ▶ Permanent damage may result if cables are not routed appropriately.

The probe head contains an intrinsically safe level of electrical potential. If the probe head is installed in an enclosure, an optional interlock switch may be fitted to the enclosure lid such that opening the enclosure will operate the laser interlock and shut the laser down within milliseconds of the enclosure being opened.

2.8.3 Laser radiation emission indicator

In addition to the CDRH-compliant indicators on the base unit of a Raman Rxn2/Rxn4 (hybrid configuration) analyzer, the Rxn-20 probe has an electrically powered CDRH-compliant laser emission indicator.

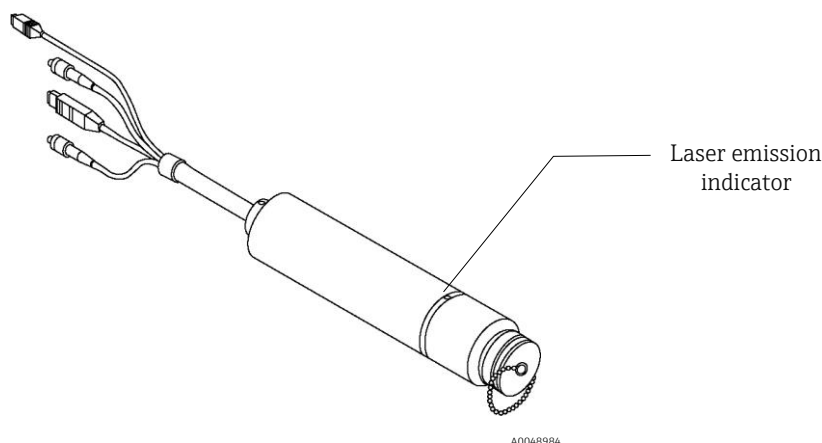

Figure 2. Location of the laser emission indicator on the Rxn-20 probe

2.8.4 Hazardous area approvals

The Rxn-20 probe has been third-party approved for use in hazardous areas in accordance with Article 17 of Directive 2014/34/EU of the European Parliament and of the Council dated 26 February 2014. The Rxn-20 probe has been certified to the ATEX Directive for use in Europe, as well as in other countries accepting ATEX-certified equipment.



Figure 3. ATEX label for use in hazardous areas

The Rxn-20 probe has also been approved for use in hazardous areas in the United States (US) and Canada by the [Canadian Standards Association](#) when installed in accordance with the Rxn-20 Hazardous Area Installation Diagram (3000272).

The products are eligible to bear the CSA Mark shown with adjacent indicators 'C' and 'US' for Canada and US or with adjacent indicator 'US' for US only or without either indicator for Canada only.



Figure 4. CSA label for use in hazardous areas in the US and Canada

The Rxn-20 probe can also be marked for [International Electrotechnical Commission](#) Certification Systems for Explosive Atmospheres (IECEx) when installed in accordance with the Rxn-20 Hazardous Area Installation Diagram (3000272).

3 Product description

3.1 The Rxn-20 probe

The Rxn-20 Raman spectroscopic probe, powered by Kaiser Raman technology, is optimized for large volumetric measurements, enabling representative, focus-free, quantitative Raman measurements of solids and semi-solids in a laboratory or process plant setting. The Rxn-20 probe is designed to be compatible with Endress+Hauser Raman Rxn2/Rxn4 (hybrid configuration) analyzers operating at 785 nm.

To enhance sampling flexibility, both immersion and non-contact sampling optics are available for the Rxn-20 probe. The Rxn-20 probe has a threaded beam block cap attached for safety.

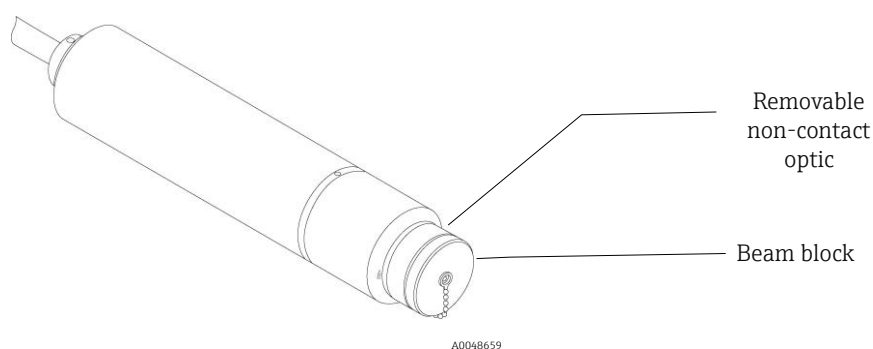

Figure 5. Stainless steel Rxn-20 probe





3.2 Benefits of the probe head design

The Rxn-20 probe addresses previous limitations of traditional spectroscopic process analytical technology (PAT) systems for representative analysis.

- **Representative measurement:** The larger laser spot size allows a much greater portion of a sample to be interrogated in a single measurement.
- **Reproducible measurement:** The depth of field provided by the probe design eliminates the sensitivity of the Raman response to small changes in sample placement from one measurement to the next and also allows for depth information to be obtained.
- **Excellent model transfer:** Instrument design, calibration protocol and measurement reproducibility allow for transfer between scales and units within a GMP environment.
- **Non-destructive measurement:** The significantly lower energy density reduces the potential for thermally induced changes or damage/form change to solid samples.

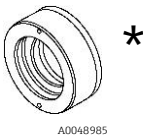
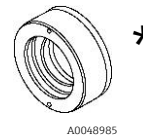
3.3 Raman Rxn-20 probe accessories

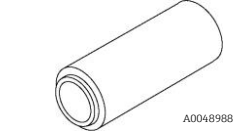
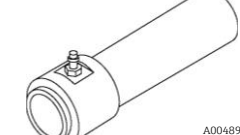
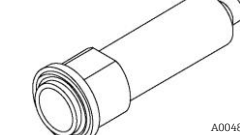
The probe is compatible with the accessories below to meet the requirements of different applications.

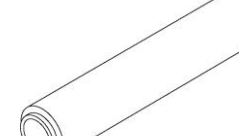
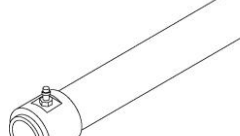
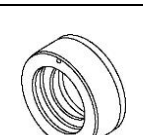
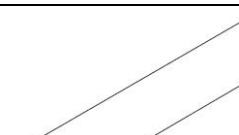
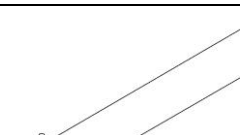
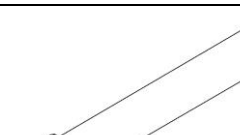
Spot size	Lens adapters 38.1 mm (1.50 in.) diameter	Lens tubes: non-purged 31.8 mm (1.25 in.) diameter, for Enclosed Sample Compartment	Lens tubes: purgeable 25.4 mm (1.00 in.) diameter	Immersion optics 25.4 mm (1.00 in.) diameter
	316 stainless steel, PTFE	Aluminum alloy 6061-T651, anodized black	316 stainless steel with 303 stainless barbed nipple	316 stainless steel, Kalrez, PTFE, sapphire
1 mm (0.04 in.)	 *	X	X	X
1.5 mm (0.06 in.)	 *	X	X	X
3 mm (0.12 in.)				
4.7 mm (0.19 in.)				X
6 mm (0.24 in.)				

*Compatible with small sample chamber using 76.2 mm (3.00 in.) lens tube mounted between the probe body and lens adapter

Table 4. Accessories for Rxn-20 probe

3.3.1 Rxn-20 probe with lens adapter

The Rxn-20 probe is capable of measuring at various spot sizes from 1 to 6 mm (0.04 to 0.24 in.) when equipped with a lens adapter. In general, larger size lenses have a larger focus tolerance, which enables focus-free measurements of uneven solid beds or samples. Smaller size lenses provide representative measurements of smaller-sized solids or turbid media.

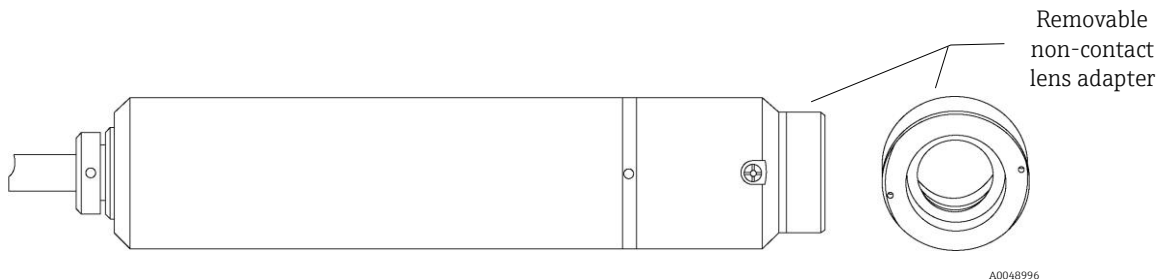

Figure 6. Rxn-20 probe with lens adapter

3.3.2 Rxn-20 probe with lens adapter and lens tube

The Rxn-20 probe and non-contact lens may be supplemented by a purgeable or non-purged lens tube accessory designed to allow a low-flow of an appropriate gas to prevent material obscuring the probe lens. The purged lens accessory interfaces the Rxn-20 probe to a coater or other batch operations where maintaining the cleanliness of the lens is necessary. The non-purged lens tube accessory is compatible with the sample chamber, allowing for easy analysis in laboratory applications.

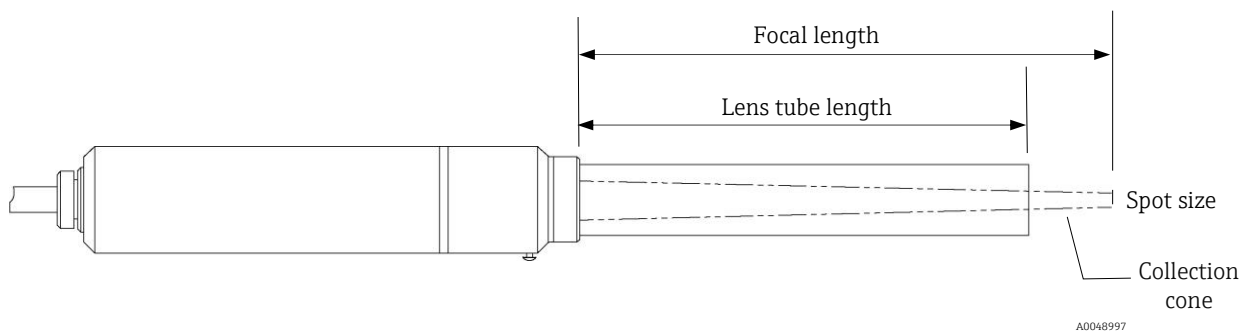

Figure 7. Rxn-20 probe with lens adapter and non-purged lens tube

3.3.3 Rxn-20 probe with lens adapter and immersion optic

Another optional add-on to the Rxn-20 lens adapter is an immersion optic, which enables direct sample contact with slurries and solids (either *in situ* or off-line).

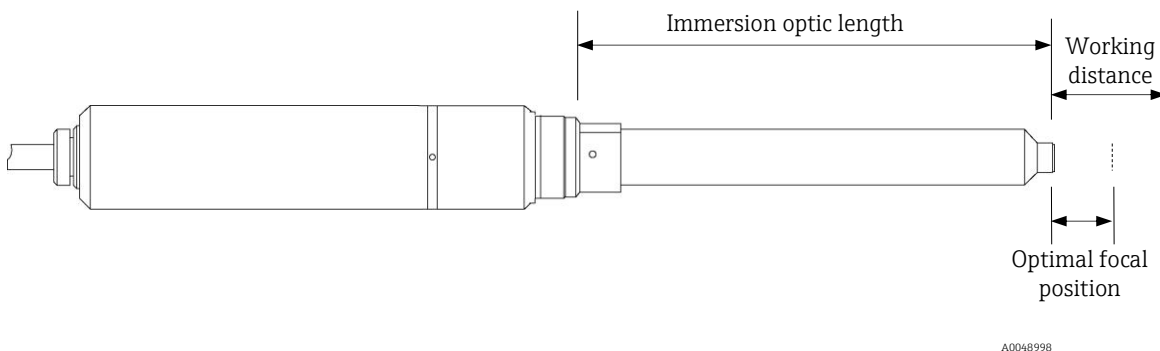

Figure 8. Rxn-20 probe with lens adapter and immersion optic

4 Incoming product acceptance and product identification

4.1 Incoming acceptance

1. Verify that the packaging is undamaged. Notify the supplier of any damage to the packaging. Keep the damaged packaging until the issue has been resolved.
2. Verify that the contents are undamaged. Notify the supplier of any damage to the delivery contents. Keep the damaged goods until the issue has been resolved.
3. Check that the delivery is complete and nothing is missing. Compare the shipping documents with your order.
4. Pack the product for storage and transportation in such a way that it is protected against impact and moisture. The original packaging offers the best protection. Make sure to comply with the permitted ambient conditions.

If you have any questions, please contact your supplier or your local sales center.

NOTICE

Probe may be damaged during transport if packaged inadequately.

4.2 Product identification

4.2.1 Label

At a minimum, the probe head/tag is labeled with the following information:

- Endress+Hauser branding
- Serial number

Where size allows, the following information is also included:

- Product identification (e.g., Rxn-20)
- Extended order code
- Manufacturer information
- Key functional aspects of the probe (e.g., material, wavelength, focal depth)
- Safety warnings and certification information, as applicable

Compare the information on the label/tag with the order.

4.2.2 Manufacturer address

Endress+Hauser
371 Parkland Plaza
Ann Arbor, MI 48103 USA

4.3 Scope of delivery

The scope of delivery comprises:

- Rxn-20 probe in the configuration ordered
- *Rxn-20 Raman spectroscopic probe Operating Instructions* manual
- Rxn-20 Probe Certificate of Product Performance
- Local declarations of conformity, if applicable
- Certificates for hazardous zone use, if applicable
- Rxn-20 probe optional accessories, if applicable
- Material certificates, if applicable

If you have any queries, please contact your supplier or local sales center.

4.4 Certificates and approvals

Refer to the *Rxn-20 Raman spectroscopic probe Safety Instructions* manual for detailed certification and approval information.

5 Probe head and fiber optic connection

The Rxn-20 probe connects to the Raman Rxn (hybrid configuration) analyzer via a fiber optic bundle. Standard fiber cable lengths are 3, 10, or 15 m (9.84, 32.81, or 49.21 ft.). Custom cable lengths are also available.

NOTICE

Connection of the probe to the fiber optic cable must be conducted by a qualified Endress+Hauser engineer or specially trained technical personnel.

- ▶ Unless trained by qualified personnel, customer attempts to connect the probe to the fiber optic cable can result in damage and may void the warranty.
- ▶ Contact your local Endress+Hauser service representative for additional support regarding the probe and fiber cable connection.

The fiber optic bundle connects the Rxn-20 probe to the analyzer via the following:

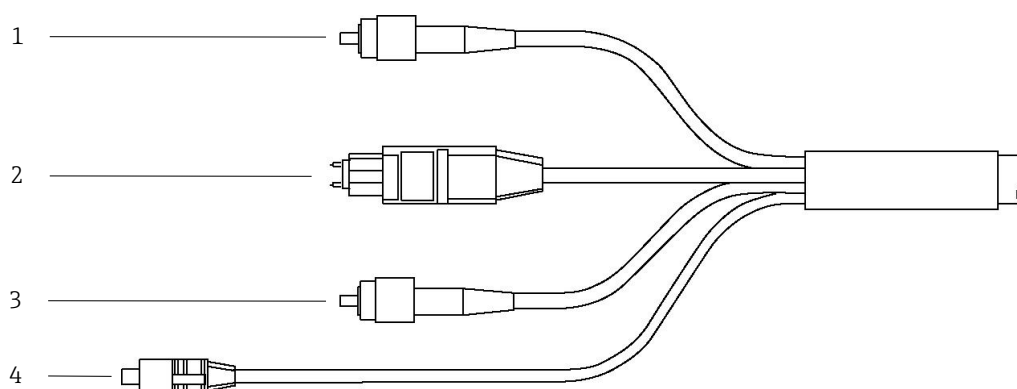

A0048999

Figure 9. Rxn-20 probe fiber optic bundle

#	Name	Description
1	Excitation fiber	Fiber channel (FC) type fiber that provides fiber optic laser radiation output
2	Collection fiber	Mechanical transfer (MT) type fiber for Raman scatter collection
3	Calibration fiber	FC type fiber that provides fiber optic auto-calibration source output
4	Laser interlock connector	Electrical interlock loop connector; in case of fiber breakage, laser will turn OFF

Table 5. Rxn-20 probe fiber optic bundle

Refer to the applicable Raman Rxn2 or Raman Rxn4 analyzer operating instructions for analyzer connection details.

6 Installation

Prior to installation in the process, verify that the amount of laser power out of each probe head is no more than the amount specified in the Hazardous Area Equipment Assessment (4002266) or equivalent.

Standard eye and skin safety precautions for Class 3B laser products (as per EN-60825/IEC 60825-14) should be observed as described below.

⚠ WARNING	Standard precautions for laser products should be observed. <ul style="list-style-type: none">▶ Probe heads should always be capped or pointed away from people toward a diffuse target if not installed in a sample chamber.
⚠ CAUTION	If stray light is allowed to enter an unused probe head, it will interfere with data collected from a used probe head and may cause calibration failure or measurement errors. <ul style="list-style-type: none">▶ Unused probe heads should ALWAYS be capped to prevent stray light from entering the probe head.
NOTICE	Take care to install the probe head such that it measures the sample or region of interest.

6.1 Hazardous area installation

The probe head has been designed to be installed in hazardous areas. It must be installed according to the Rxn-20 Hazardous Area Installation Diagram (3000272).

NOTICE

When installing the probe head *in situ*, the user must provide the strain relief to the fiber optic cable at the probe head installation location.

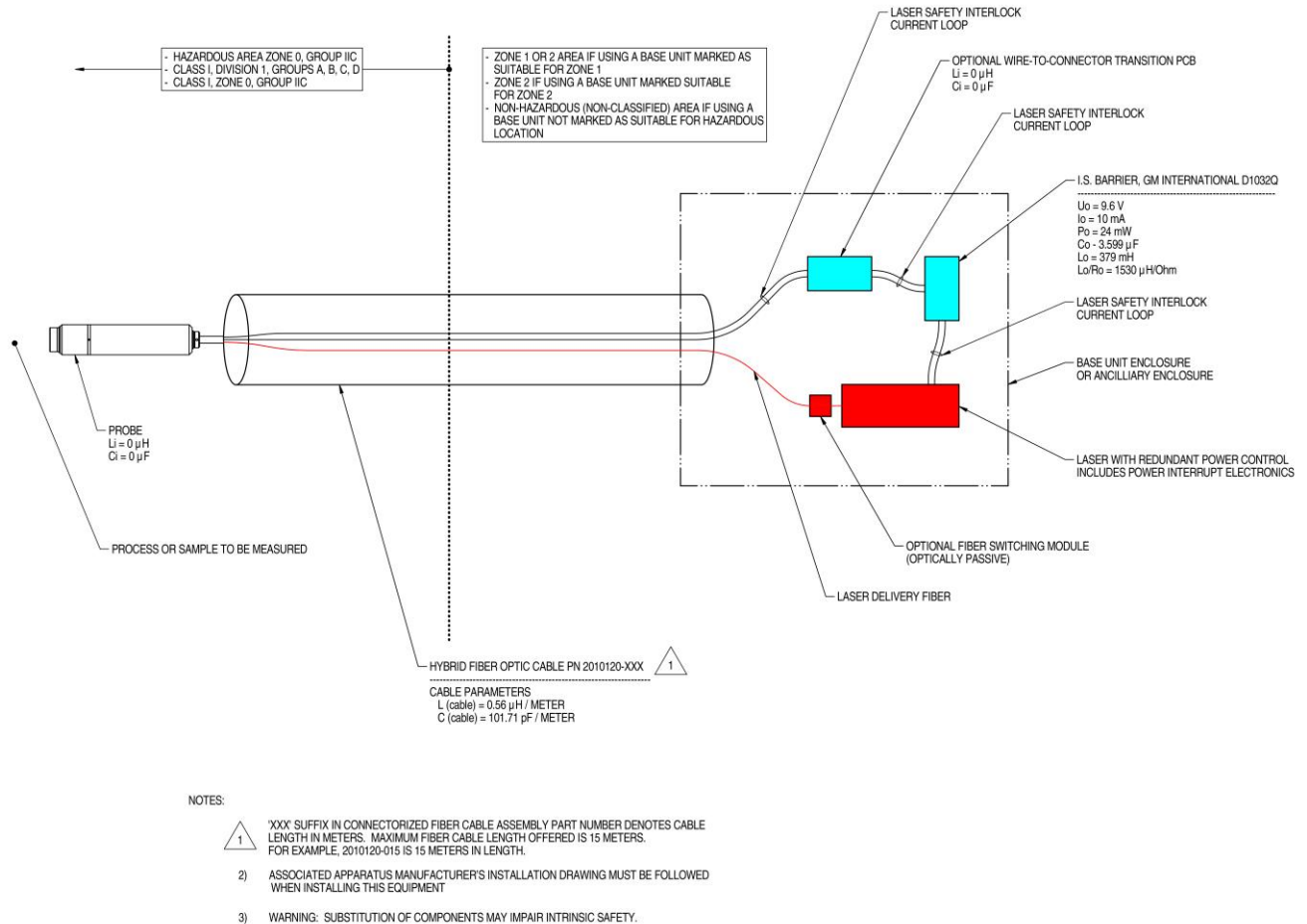

Figure 10. Rxn-20 Hazardous Area Installation Diagram (3000272 version X2)

6.2 Process and probe head compatibility

Prior to installation, the user must check that the probe head pressure and temperature ratings, as well as the materials from which the probe head is made, are compatible with the process into which it is being inserted.

The probe head should be installed using sealing techniques (e.g., compression fittings) appropriate and typical for the vessel or piping.

WARNING

If the probe head will be installed in a high temperature or pressure process, additional safety precautions must be taken to avoid equipment damage or safety hazards.

A blow-out protection device is highly recommended in accordance with local safety standards.

- It is the responsibility of the user to determine if any blow-out protection devices are required and ensure they are attached to the probe head during installation.

6.3 Certifications and markings

Endress+Hauser offers certifications for the Rxn-20 probe according to the standards below. Select the desired certification(s) and the probe head or probe head tag is marked accordingly.

Type	Description
ATEX marking and installations	<ul style="list-style-type: none"> ▪ ATEX marking is available as an option at the time of purchase. Available markings: II 2/1 G Ex ia op is IIA or IIB or IIB+H2 or IIC T3 or T4 or T6 Ga ▪ Prior to the order, the marking for the particular probe head/application must be determined. The customer must do one of the following: <ul style="list-style-type: none"> ○ Work with purchasing to identify the required marking OR ○ Provide Endress+Hauser with a completed copy of the Hazardous Area Equipment Assessment (4002266). ▪ Endress+Hauser will mark the Rxn-20 probes according to the customer’s provided information. Endress+Hauser is not responsible for the customer’s inaccuracies. <p>⚠ WARNING</p> <p>In an ATEX-governed environment, only ATEX-marked probe heads may be used.</p>
North American hazardous area marking and installations	<ul style="list-style-type: none"> ▪ CSA marking is available as an option at the time of purchase. Available markings: Ex ia op is IIA or IIB or IIB + H2 or IIC T3 or T4 or T6 Ga Class I, Zone 0 AEx ia op is IIA or IIB or IIB + H2 or IIC T3 or T4 or T6 Ga Class I, Division 1, Groups A, B, C, D T3/T4/T6 ▪ Prior to the order, the marking for the particular probe head/application must be determined. The customer must do one of the following: <ul style="list-style-type: none"> ○ Work with purchasing to identify the required marking OR ○ Provide Endress+Hauser with a completed copy of the Hazardous Area Equipment Assessment (4002266). ▪ Endress+Hauser will mark the Rxn-20 probes according to the customer’s provided information. Endress+Hauser is not responsible for the customer’s inaccuracies. ▪ For North American applications into classified environments, the probe head will have the CSA mark and can be considered intrinsically safe when installed according to the Rxn-20 Hazardous Area Installation Diagram (3000272). <p>⚠ WARNING</p> <p>In a CSA-governed environment, only CSA-marked probe heads may be used.</p>
IECEX hazardous area marking and installations	<ul style="list-style-type: none"> ▪ IECEX marking is available as an option at the time of purchase. Available markings: Ex ia op is IIA or IIB or IIB + H2 or IIC T3 or T4 or T6 Ga IECEX ITS 14.0015X ▪ Prior to the order, the marking for the particular probe head/application must be determined. The customer must do one of the following: <ul style="list-style-type: none"> ○ Work with purchasing to identify the required marking OR ○ Provide Endress+Hauser with a completed copy of the Hazardous Area Equipment Assessment (4002266). ▪ Endress+Hauser will mark the Rxn-20 probes according to the customer’s provided information. Endress+Hauser is not responsible for the customer’s inaccuracies. ▪ For IECEX applications into classified environments, the probe head will have the IECEX mark and can be considered intrinsically safe when installed according to the Rxn-20 Hazardous Area Installation Diagram (3000272). <p>⚠ WARNING</p> <p>In an IECEX-governed environment, only IECEX-marked probe heads may be used.</p>

Table 6. Certifications and markings

7 Commissioning

The Rxn-20 probe is delivered ready to connect to the Raman Rxn2 (hybrid configuration) or Raman Rxn4 (hybrid configuration) analyzer. No additional alignment or adjustment to the probe head itself is required. Connection of the probe head to the Raman Rxn2/Rxn4 (hybrid configuration) analyzer must be conducted by a qualified Endress+Hauser engineer.

Follow the instructions below to commission the probe for use.

NOTICE

The probe installation and usage parameters may have specific requirements governed by the associated application.

- ▶ Please refer to the appropriate certificate for ATEX, CSA, or IECEx for those specific requirements.

7.1 Receipt of probe

Perform the steps for incoming product acceptance described in Section 4.1 → .

Additionally, upon receipt, remove the shipping container cover and inspect the sapphire window for any damage prior to installing into the process. If the window shows any visible cracks, please contact the supplier.

7.2 Probe calibration and verification

The probe and the analyzer must be calibrated before use.

Refer to the applicable Raman Rxn2 or Raman Rxn4 analyzer operating instructions for steps to:

- Perform internal analyzer calibration; may include alignment calibration, full wavelength calibration or full laser wavelength calibration depending on status of analyzer
- Perform probe calibration; requires a Calibration Accessory (HCA) with an appropriate optic adapter
- Perform probe verification; verifies the calibration results using a standard reference sample
- View calibration and verification reports

The Raman RunTime software will not allow spectra to be collected without passing internal analyzer and probe calibrations. Passing the probe verification step is not required but highly recommended.

Raman Rxn2 or Raman Rxn4 analyzer operating instructions are available by searching the Downloads area of the Endress+Hauser web site: <https://endress.com/downloads>

8 Operation

The Rxn-20 probe is designed for large volumetric measurements of solids and semi-solids in a laboratory or process plant setting. The Rxn-20 probe is compatible with Endress+Hauser Raman Rxn2/Rxn4 (hybrid configuration) analyzers operating at 785 nm.

The probe head images the laser excitation light from the fiber bundle onto the sample and images the sample emission onto another fiber bundle. The fiber bundle connects the probe head to the analyzer.

The Rxn-20 probe illuminates a large surface area and eliminates the need to align the probe head for surface roughness. The principles of operation are below.

8.1 Silica Raman removal

Laser light traveling through a silica optical fiber generates silica Raman emission. If this emission were to reach the spectrograph, it could obscure the Raman spectrum of the sample. This problem is especially severe when long lengths of optical fiber are used. The Rxn-20 probe removes the silica Raman light from the laser light after the light exits the excitation fiber bundle and before it reaches the sample. The probe head also removes laser light from the sample emission before it reaches the collection fiber bundle. As a result, silica Raman bands are not observed in spectra collected with a Rxn-20 probe, even when very long optical fibers are used.

8.2 Focusing excitation radiation

The standard Rxn-20 probe is designed to focus the excitation light on a spot 6 mm (0.24 in.) in diameter for large spot sampling. The large excitation spot and multiple collection fibers in the Rxn-20 probe achieve heterogenous solids sampling in both the axial and lateral dimensions. In doing so, it provides information on deeper layers in addition to the surface, which is useful for measuring heterogenous solids such as tablets, capsules, food solids, and polymer beads.

Alternate excitation spot sizes are available. Refer to the sampling accessories in Section 3.3 → .

Refer to the applicable Raman Rxn2 or Raman Rxn4 analyzer operating instructions for additional instructions for use.

9 Diagnostics and troubleshooting

Refer to the table below when troubleshooting issues with the Rxn-20 probe. If the probe head is damaged, isolate the probe head from the process and turn off the laser prior to evaluation. Contact your service representative as needed for assistance.

Symptom		Possible cause	Action
1	Substantial reduction in signal or signal-to-noise ratio	Lens/window fouling	1. Carefully remove probe from the process, decontaminate, and inspect lens/window at tip of probe. 2. If necessary, clean the lens/window before returning it to service. See Section 10.1 →  .
		Cracked but intact fiber	Verify condition of fiber and contact your service representative for replacement.
2	Complete loss of signal while laser is powered and laser emission indicator is lit	Broken fiber without interlock wire breakage	Ensure all fiber connections are secure. Verify condition of fiber and contact your service representative for replacement.
3	Laser emission indicator on probe is not lit	Damaged fiber assembly	Look for signs of breakage in fiber. Contact your service representative for replacement.
		Laser interlock wire disconnected	Ensure laser interlock wire and remote interlock connector for the probe/channel are properly connected at the analyzer.
4	Decreased laser power or collection efficiency	Contaminated fiber connection	Carefully clean the probe fiber cable ends at the analyzer. Refer to the applicable Raman Rxn analyzer operating instructions for cleaning instructions and steps for starting up a new probe.
		Incorrect combination of lens adapter and lens tube or immersion optic	Select the appropriate lens adapter and lens tube or immersion optic for the desired spot size. Refer to Table 4 for acceptable combinations.
5	Laser emission indicator goes out	Fiber breakage	Contact your service representative to repair or replace the fiber cable.
6	Laser interlock on analyzer causes laser to shut down	Laser interlock activated	Check for fiber breakage on all connected fiber optic cable channels and ensure remote interlock connectors are in place for the same.
7	Unrecognized bands or patterns in the spectra	Cracked but intact fiber	Verify possible causes and contact your service representative to return the damaged product.
		Contaminated probe/lens tip	
		Contaminated internal optics of probe due to leakage	
8	Other unexplained negative performance of the probe	Physical damage to probe head or accessories	Contact your service representative to return the damaged product.

Table 7. Troubleshooting

10 Maintenance

10.1 Cleaning the lens/window

Use a lens wipe and a water-based lens cleaning solution to gently wipe away any contaminant on the lens adapter or probe window. For more aggressive cleaning, use isopropyl alcohol and a lens wipe to gently wipe away any contaminant.

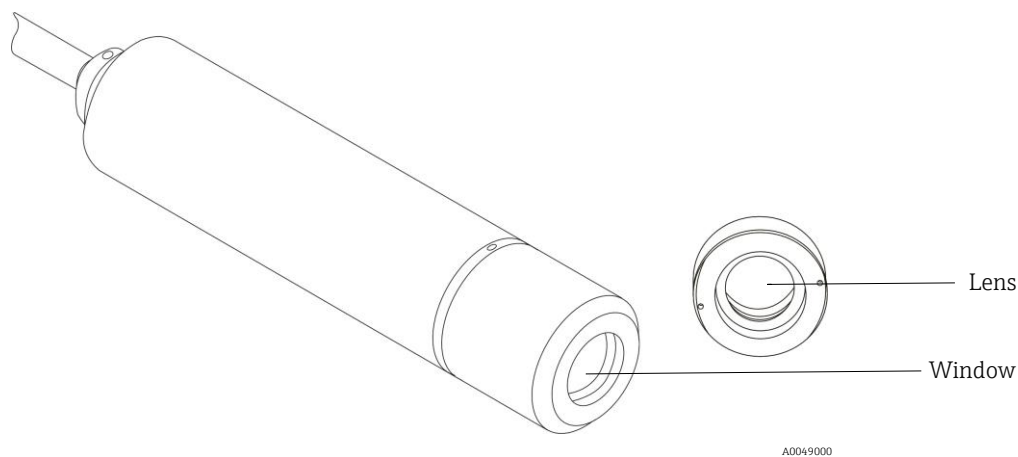

Figure 11. Rxn-20 probe window and lens

10.2 Inspecting and cleaning the optical fibers

The fiber optic bundle connectors must be clean and free of debris and oil to achieve optimal performance. If cleaning is required, refer to the applicable Raman Rxn2 or Raman Rxn4 analyzer operating instructions to clean ONLY the excitation and calibration fiber tips.

11 Repair

Repairs not described in this document must be carried out only directly at the manufacturer's site or by the service organization. For Technical Service, refer to our website (<https://endress.com/contact>) for the list of local sales channels in your area.

If a product must be returned for repair or replacement, follow all decontamination procedures indicated by your service provider.

⚠ WARNING

Failure to properly decontaminate wetted parts before return can result in a fatal or serious injury.

To ensure swift, safe and professional product returns, please contact your service organization.

For additional product return information, refer to the following site and select the applicable market/region:
<https://www.endress.com/en/instrumentation-services/instrumentation-repair>

12 Technical data

12.1 General specifications

Item	Description	
Maximum laser power into probe head	< 499 mW	
Compatible wavelength	785 nm	
Sample interface	temperature	10 to 40 °C (50 to 104 °F)
	pressure	ambient
	relative humidity	20 to 80 %, non-condensing
Probe head measurements	length	209.55 mm (8.25 in.) without lens adapter 312 mm (12.29 in.) with fiber cable bend radius
	diameter	48 mm (1.89 in.)
	weight	approximately 2 lbs. (with cable)
Materials of construction	probe head body	316L stainless steel
	window	optical-grade materials
	fiber optic cable	design: PVC jacketed, proprietary construction connections: FC, MT, and electrical
Fiber optic cable	length	3, 10 or 15 m standard (9.84, 32.81 or 49.21 ft.) custom lengths are available
	minimum bend radius	75 mm (2.96 in.)
	temperature	-40 to 70 °C (-40 to 158 °F)
Nominal beam diameter at focal position	standard	6 mm (0.24 in.)
	optional	4.7, 3, or 1 mm (0.19, 0.12, or 0.04 in.)

Table 8. General specifications

12.2 Maximum permissible exposure

The maximum permissible exposure (MPE) is the maximum level of laser radiation exposure that can occur before causing ocular or skin damage. The MPE is calculated using the laser wavelength (λ) in nanometers, the duration of the exposure in seconds (t), and the energy involved ($J \cdot cm^{-2}$ or $W \cdot cm^{-2}$).

A correction factor (C_A) may also be required and can be determined below.

Wavelength λ (nm)	Correction factor C_A
400 to 700	1
700 to 1050	$10^{0.002(\lambda-700)}$
1050 to 1400	5

Table 9. Wavelength dependent correction factor C_A

12.2.1 MPE for ocular exposure

The ANSI Z136.1 standard provides means to perform MPE for ocular exposure. Please refer to the standard to calculate the relevant MPE levels for the case of laser exposure from the Rxn-20 probe and from the unlikely occurrence of laser exposure from a broken optical fiber.

MPE for point source ocular exposure to a laser beam				
Wavelength λ (nm)	Exposure duration t (s)	MPE calculation		MPE where $C_A = 1.4791$
		(J·cm ⁻²)	(W·cm ⁻²)	
785	10 ⁻¹³ to 10 ⁻¹¹	1.5 $C_A \times 10^{-8}$	-	2.2 × 10 ⁻⁸ (J·cm ⁻²)
	10 ⁻¹¹ to 10 ⁻⁹	2.7 $C_A t^{0.75}$	-	Insert time (t) and calculate
	10 ⁻⁹ to 18 × 10 ⁻⁶	5.0 $C_A \times 10^{-7}$	-	7.40 × 10 ⁻⁷ (J·cm ⁻²)
	18 × 10 ⁻⁶ to 10	1.8 $C_A t^{0.75} \times 10^{-3}$	-	Insert time (t) and calculate
	10 to 3 × 10 ⁴	-	$C_A \times 10^{-3}$	1.4971 × 10 ⁻³ (W·cm ⁻²)

Table 10. MPE for ocular exposure with 785 nm laser emission

12.2.2 MPE for skin exposure

The ANSI Z136.1 standard provides means to perform MPE for skin exposure. Please refer to the standard to calculate the relevant MPE levels for the case of laser exposure from the Rxn-20 probe and from the unlikely occurrence of laser exposure from a broken optical fiber.

MPE for skin exposure to a laser beam				
Wavelength λ (nm)	Exposure duration t (s)	MPE calculation		MPE where $C_A = 1.4791$
		(J·cm ⁻²)	(W·cm ⁻²)	
785	10 ⁻⁹ to 10 ⁻⁷	2 $C_A \times 10^{-2}$	-	2.9582 × 10 ⁻² (J·cm ⁻²)
	10 ⁻⁷ to 10	1.1 $C_A t^{0.25}$	-	Insert time (t) and calculate
	10 to 3 × 10 ⁴	-	0.2 C_A	2.9582 × 10 ⁻¹ (W·cm ⁻²)

Table 11. MPE for skin exposure with 785 nm laser emission

12.3 Nominal hazard zone

The focusing optic configurations below are available for the Rxn-20 probe. Use the dimensions to calculate the nominal hazard zone.

Laser spot size (diameter) (b_0)	Optic focal length (f_0)	Nominal ocular hazard distance (NOHD) equation
1 mm (0.04 in.)	35 mm (1.38 in.)	$r_{\text{NOHD}} = (f_0/b_0)(4\Phi/\pi\text{MPE})^{1/2}$ $\Phi = \text{Laser Power output in Watts}$
1.5 mm (0.06 in.)	50 mm (1.97 in.)	
3 mm (0.12 in.)	125 mm (4.93 in.)	
4.7 mm (0.19 in.)	200 mm (7.88 in.)	
6 mm (0.24 in.)	250 mm (9.84 in.)	

Table 12. Nominal hazard zone calculation

Refer to the applicable Raman Rxn2 or Raman Rxn4 analyzer operating instructions for analyzer-specific information regarding nominal hazard zone calculations.

13 Supplementary documentation

All documentation is available:

- On the Endress+Hauser Operations App for smartphone/tablet
- In the Downloads area of the Endress+Hauser website: <https://endress.com/downloads>

Part number	Document type	Document title
KA01547C	Brief Operating Instructions	Rxn-20 Raman spectroscopic probe Brief Operating Instructions
XA02747C	Safety Instructions	Rxn-20 Raman spectroscopic probe Safety Instructions
TI01631C	Technical Information	Rxn-20 Raman spectroscopic probe Technical Information

Table 13. Supplementary documentation

14 Index

- accessories, 11, 12, 13
- adapters, 19
- calibration accessory, 19
- CDRH compliance, 5, 8
- certification, 8, 9, 13, 14
 - ATEX, 5, 9, 18, 19
 - compliance, 5, 8
 - CSA, 5, 9, 19
 - hazardous area, 9, 18
 - IECEX, 5, 7, 8, 9, 16, 18, 19
 - North American, 18
- electrical connection, 6
- export compliance, 4
- fiber cable
 - calibration, 15
 - cleaning, 22
 - collection, 15
 - excitation, 15
 - laser interlock, 15
 - length, 15, 24
 - minimum bend radius, 8, 24
 - temperature, 24
- glossary, 5
- hazardous area, 9, 16, 17, 18
- IEC compliance, 5, 7, 8, 16
- laser interlock, 21
- MPE
 - ocular exposure, 25
 - skin exposure, 25
- personnel requirements, 6
- probe
 - additional documents, 27
 - calibration, 19
 - cap, 7, 10
 - designated use, 6
 - immersion optic, 12
 - installation, 16, 17
 - interfaces, 12
 - lens adapter, 12
 - lens tube, 12
 - lens/window cleaning, 22
 - materials of construction, 24
 - operation, 20
 - receipt, 13
 - troubleshooting, 21
 - verification, 19
- Raman RunTime, 19
- Raman Rxn analyzer (hybrid configuration), 8, 10, 15, 19, 20
- repair, 23
- safety, 7
 - basic, 6
 - eye, 7, 16, 25
 - laser, 7, 8
 - operational, 6
 - product, 8
 - service, 7
 - skin, 16, 25
 - workplace, 6
- specifications
 - diameter, 11, 24
 - laser power, 16, 24
 - length, 24
 - pressure, 24
 - relative humidity, 24
 - temperature, 24
 - weight, 24
- symbols, 4
- technical data, 24

www.addresses.endress.com
