

# Brief Operating Instructions

## Flowmeter

### Proline Promass I

Coriolis sensor



These Brief Operating Instructions are **not** a substitute for the Operating Instructions pertaining to the device.

#### **Brief Operating Instructions Part 1 of 2: Sensor**

Contain information about the sensor.

Brief Operating Instructions Part 2 of 2: Transmitter

→  3.



A0023555

## Brief Operating Instructions for flowmeter

The device consists of a transmitter and a sensor.

The process of commissioning these two components is described in two separate manuals that together form the Brief Operating Instructions for the flowmeter:

- Brief Operating Instructions Part 1: Sensor
- Brief Operating Instructions Part 2: Transmitter

Please refer to both parts of the Brief Operating Instructions when commissioning the device, as the contents of the manuals complement one another:

### Brief Operating Instructions Part 1: Sensor

The Sensor Brief Operating Instructions are aimed at specialists with responsibility for installing the measuring device.

- Incoming acceptance and product identification
- Storage and transport
- Installation

### Brief Operating Instructions Part 2: Transmitter

The Transmitter Brief Operating Instructions are aimed at specialists with responsibility for commissioning, configuring and parameterizing the measuring device (until the first measured value).

- Product description
- Installation
- Electrical connection
- Operation options
- System integration
- Commissioning
- Diagnostic information

## Additional device documentation



These Brief Operating Instructions are the **Brief Operating Instructions part 1: Sensor**.

The "Brief Operating Instructions part 2: Transmitter" are available via:

- Internet: [www.endress.com/deviceviewer](http://www.endress.com/deviceviewer)
- Smart phone/tablet: *Endress+Hauser Operations App*

Detailed information about the device can be found in the Operating Instructions and the other documentation:

- Internet: [www.endress.com/deviceviewer](http://www.endress.com/deviceviewer)
- Smart phone/tablet: *Endress+Hauser Operations App*

# Table of contents

<b>1</b>	<b>About this document</b> .....	<b>5</b>
1.1	Symbols .....	5
<b>2</b>	<b>Basic safety instructions</b> .....	<b>6</b>
2.1	Requirements for the personnel .....	6
2.2	Intended use .....	7
2.3	Workplace safety .....	8
2.4	Operational safety .....	8
2.5	Product safety .....	8
2.6	IT security .....	9
<b>3</b>	<b>Incoming acceptance and product identification</b> .....	<b>9</b>
3.1	Incoming acceptance .....	9
3.2	Product identification .....	10
<b>4</b>	<b>Storage and transport</b> .....	<b>11</b>
4.1	Storage conditions .....	11
4.2	Transporting the product .....	11
<b>5</b>	<b>Mounting</b> .....	<b>13</b>
5.1	Mounting requirements .....	13
5.2	Mounting the measuring device .....	19
5.3	Post-installation check .....	20
<b>6</b>	<b>Disposal</b> .....	<b>21</b>
6.1	Removing the measuring device .....	21
6.2	Disposing of the measuring device .....	21

# 1 About this document

## 1.1 Symbols

### 1.1.1 Safety symbols

#### **DANGER**

This symbol alerts you to a dangerous situation. Failure to avoid this situation will result in serious or fatal injury.

#### **WARNING**

This symbol alerts you to a dangerous situation. Failure to avoid this situation can result in serious or fatal injury.









#### **CAUTION**

This symbol alerts you to a dangerous situation. Failure to avoid this situation can result in minor or medium injury.





#### **NOTICE**

This symbol contains information on procedures and other facts which do not result in personal injury.

### 1.1.2 Symbols for certain types of information





Symbol	Meaning	Symbol	Meaning
	<b>Permitted</b> Procedures, processes or actions that are permitted.		<b>Preferred</b> Procedures, processes or actions that are preferred.
	<b>Forbidden</b> Procedures, processes or actions that are forbidden.		<b>Tip</b> Indicates additional information.
	Reference to documentation		Reference to page
	Reference to graphic	<b>1, 2, 3...</b>	Series of steps
	Result of a step		Visual inspection

### 1.1.3 Electrical symbols





Symbol	Meaning	Symbol	Meaning
	Direct current		Alternating current
	Direct current and alternating current		<b>Ground connection</b> A grounded terminal which, as far as the operator is concerned, is grounded via a grounding system.

Symbol	Meaning
	<p><b>Potential equalization connection (PE: protective earth)</b> Ground terminals that must be connected to ground prior to establishing any other connections.</p> <p>The ground terminals are located on the interior and exterior of the device:</p> <ul style="list-style-type: none"> <li>■ Interior ground terminal: potential equalization is connected to the supply network.</li> <li>■ Exterior ground terminal: device is connected to the plant grounding system.</li> </ul>

### 1.1.4 Tool symbols

Symbol	Meaning	Symbol	Meaning
	Torx screwdriver		Flat-blade screwdriver
	Phillips head screwdriver		Allen key
	Open-ended wrench		

### 1.1.5 Symbols in graphics

Symbol	Meaning	Symbol	Meaning
1, 2, 3,...	Item numbers		Series of steps
A, B, C, ...	Views	A-A, B-B, C-C, ...	Sections
	Hazardous area		Safe area (non-hazardous area)
	Flow direction		

## 2 Basic safety instructions

### 2.1 Requirements for the personnel

The personnel must fulfill the following requirements for its tasks:

- ▶ Trained, qualified specialists must have a relevant qualification for this specific function and task.
- ▶ Are authorized by the plant owner/operator.
- ▶ Are familiar with federal/national regulations.
- ▶ Before starting work, read and understand the instructions in the manual and supplementary documentation as well as the certificates (depending on the application).
- ▶ Follow instructions and comply with basic conditions.

## 2.2 Intended use

### Application and media

The measuring device described in this manual is intended only for the flow measurement of liquids and gases.

Depending on the version ordered, the measuring device can also measure potentially explosive, flammable, poisonous and oxidizing media.

Measuring devices for use in hazardous areas, in hygienic applications or in applications where there is an increased risk due to process pressure, are marked accordingly on the nameplate.

To ensure that the measuring device remains in proper condition for the operation time:

- ▶ Keep within the specified pressure and temperature range.
- ▶ Only use the measuring device in full compliance with the data on the nameplate and the general conditions listed in the Operating Instructions and supplementary documentation.
- ▶ Based on the nameplate, check whether the ordered device is permitted for the intended use in the hazardous area (e.g. explosion protection, pressure vessel safety).
- ▶ Use the measuring device only for media to which the process-wetted materials are sufficiently resistant.
- ▶ If the ambient temperature of the measuring device is outside the atmospheric temperature, it is absolutely essential to comply with the relevant basic conditions as specified in the device documentation.
- ▶ Protect the measuring device permanently against corrosion from environmental influences.

### Incorrect use

Non-designated use can compromise safety. The manufacturer is not liable for damage caused by improper or non-designated use.

#### **WARNING**

#### **Danger of breakage due to corrosive or abrasive fluids and ambient conditions!**

- ▶ Verify the compatibility of the process fluid with the sensor material.
- ▶ Ensure the resistance of all fluid-wetted materials in the process.
- ▶ Keep within the specified pressure and temperature range.

#### **NOTICE**

#### **Verification for borderline cases:**

- ▶ For special fluids and fluids for cleaning, Endress+Hauser is glad to provide assistance in verifying the corrosion resistance of fluid-wetted materials, but does not accept any warranty or liability as minute changes in the temperature, concentration or level of contamination in the process can alter the corrosion resistance properties.

## Residual risks

### WARNING

**If the temperature of the media or electronics unit is high or low, this may cause the surfaces of the device to become hot or cold. This poses a risk of burns or frostbite!**

- ▶ In the case of hot or cold medium temperatures, install appropriate protection against contact.

## 2.3 Workplace safety

When working on and with the device:

- ▶ Wear the required personal protective equipment as per national regulations.

## 2.4 Operational safety

Risk of injury!

- ▶ Operate the device in proper technical condition and fail-safe condition only.
- ▶ The operator is responsible for interference-free operation of the device.

### Ambient requirements for transmitter housing made of plastic

If a plastic transmitter housing is permanently exposed to certain steam and air mixtures, this can damage the housing.

- ▶ If you are unsure, please contact your Endress+Hauser Sales Center for clarification.
- ▶ If used in an approval-related area, observe the information on the nameplate.

## 2.5 Product safety

This measuring device is designed in accordance with good engineering practice to meet state-of-the-art safety requirements, has been tested, and left the factory in a condition in which it is safe to operate.

It meets general safety standards and legal requirements. It also complies with the EU directives listed in the device-specific EU Declaration of Conformity. Endress+Hauser confirms this by affixing the CE mark to the device.

Furthermore, the device meets the legal requirements of the applicable UK regulations (Statutory Instruments). These are listed in the UKCA Declaration of Conformity along with the designated standards.

By selecting the order option for UKCA marking, Endress+Hauser confirms a successful evaluation and testing of the device by affixing the UKCA mark.

Contact address Endress+Hauser UK:

Endress+Hauser Ltd.  
Floats Road  
Manchester M23 9NF  
United Kingdom  
[www.uk.endress.com](http://www.uk.endress.com)



## 2.6 IT security

Our warranty is valid only if the product is installed and used as described in the Operating Instructions. The product is equipped with security mechanisms to protect it against any inadvertent changes to the settings.

IT security measures, which provide additional protection for the product and associated data transfer, must be implemented by the operators themselves in line with their security standards.

## 3 Incoming acceptance and product identification

### 3.1 Incoming acceptance

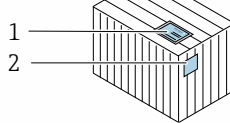
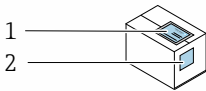

Are the order codes on the delivery note (1) and the product sticker (2) identical?

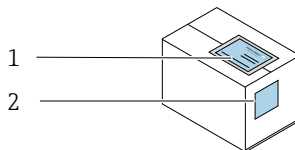
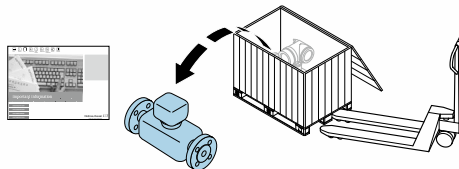

Are the order codes on the delivery note (1) and the product sticker (2) identical?

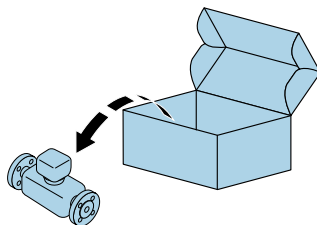

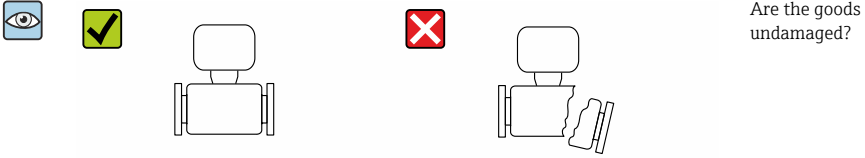

Are the goods undamaged?

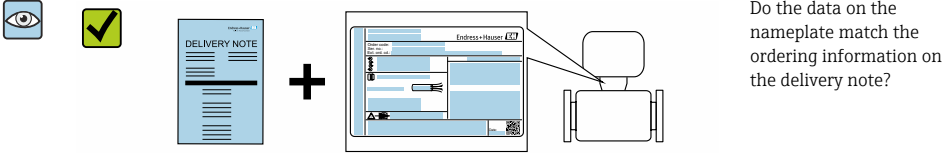

Do the data on the nameplate match the ordering information on the delivery note?



Is the envelope present with accompanying documents?

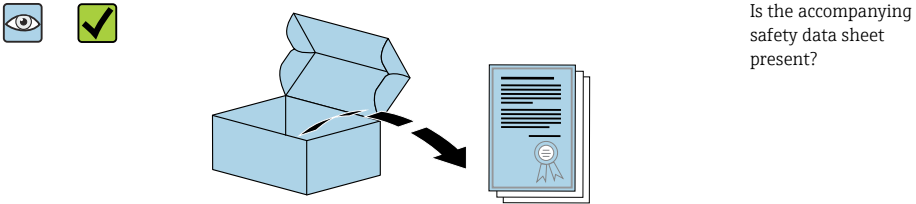

Is the accompanying safety data sheet present?

-  ■ If one of the conditions is not satisfied, contact your Endress+Hauser Sales Center.
- The Technical Documentation is available via the Internet or via the *Endress+Hauser Operations App*.

### 3.2 Product identification

The following options are available for identification of the device:

- Nameplate specifications
- Order code with breakdown of the device features on the delivery note
- Enter the serial numbers from the nameplates in the *Device Viewer* ([www.endress.com/deviceviewer](http://www.endress.com/deviceviewer)): all the information about the device is displayed.
- Enter the serial numbers from the nameplates into the *Endress+Hauser Operations App* or scan the DataMatrix code on the nameplate with the *Endress+Hauser Operations App*: all the information about the device is displayed.

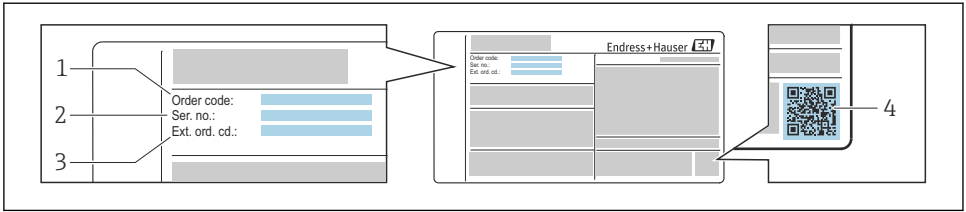

A0030196

### 1 Example of a nameplate

- 1 Order code
- 2 Serial number (Ser. no.)
- 3 Extended order code (Ext. ord. cd.)
- 4 2-D matrix code (QR code)



For detailed information on the breakdown of the specifications on the nameplate, see the Operating Instructions for the device .

## 4 Storage and transport

### 4.1 Storage conditions

Observe the following notes for storage:

- ▶ Store in the original packaging to ensure protection from shock.
- ▶ Do not remove protective covers or protective caps installed on process connections. They prevent mechanical damage to the sealing surfaces and contamination in the measuring pipe.
- ▶ Protect from direct sunlight to avoid unacceptably high surface temperatures.
- ▶ Store in a dry and dust-free place.
- ▶ Store in a dry place.
- ▶ Do not store outdoors.

### 4.2 Transporting the product

Transport the measuring device to the measuring point in the original packaging.

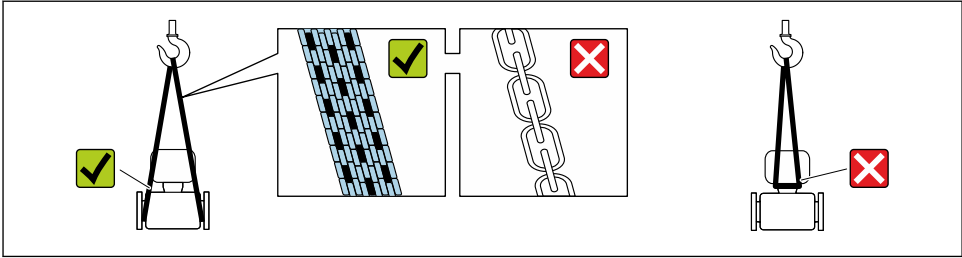

A0029252

**i** Do not remove protective covers or caps installed on process connections. They prevent mechanical damage to the sealing surfaces and contamination in the measuring tube.

#### 4.2.1 Measuring devices without lifting lugs

##### **⚠ WARNING**

**Center of gravity of the measuring device is higher than the suspension points of the webbing slings.**

Risk of injury if the measuring device slips.

- ▶ Secure the measuring device against slipping or turning.
- ▶ Observe the weight specified on the packaging (stick-on label).

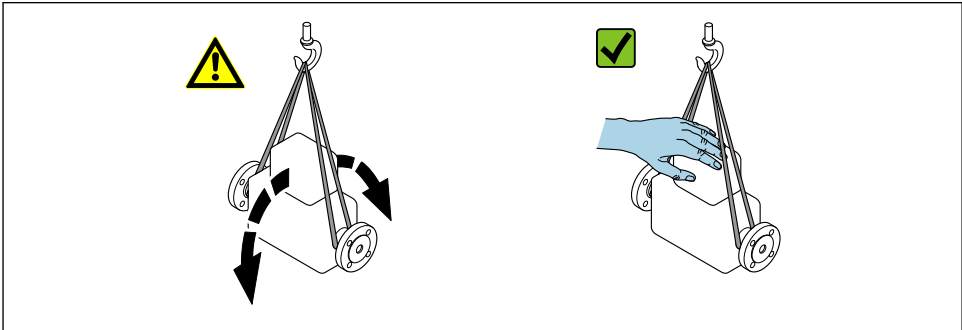

A0029214

#### 4.2.2 Measuring devices with lifting lugs

##### **⚠ CAUTION**

**Special transportation instructions for devices with lifting lugs**

- ▶ Only use the lifting lugs fitted on the device or flanges to transport the device.
- ▶ The device must always be secured at two lifting lugs at least.

#### 4.2.3 Transporting with a fork lift

If transporting in wood crates, the floor structure enables the crates to be lifted lengthwise or at both sides using a forklift.

## 5 Mounting

### 5.1 Mounting requirements

No special measures such as supports are necessary. External forces are absorbed by the construction of the device.

#### 5.1.1 Mounting position

##### Mounting location

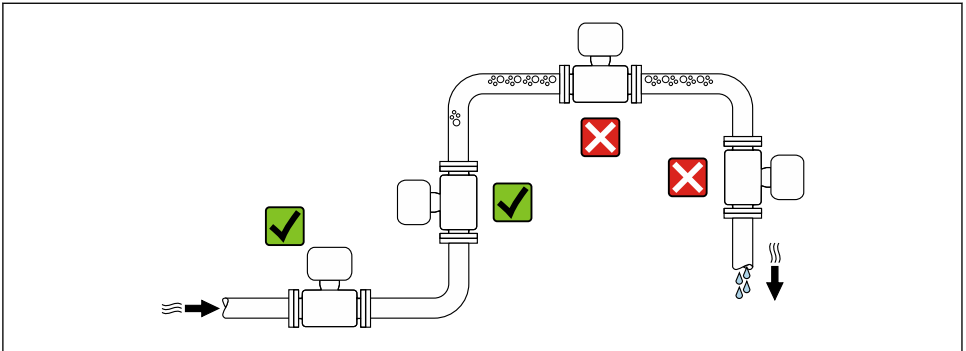

A0028772

##### *Installation in down pipes*

However, the following installation suggestion allows for installation in an open vertical pipeline. Pipe restrictions or the use of an orifice with a smaller cross-section than the nominal diameter prevent the sensor running empty while measurement is in progress.

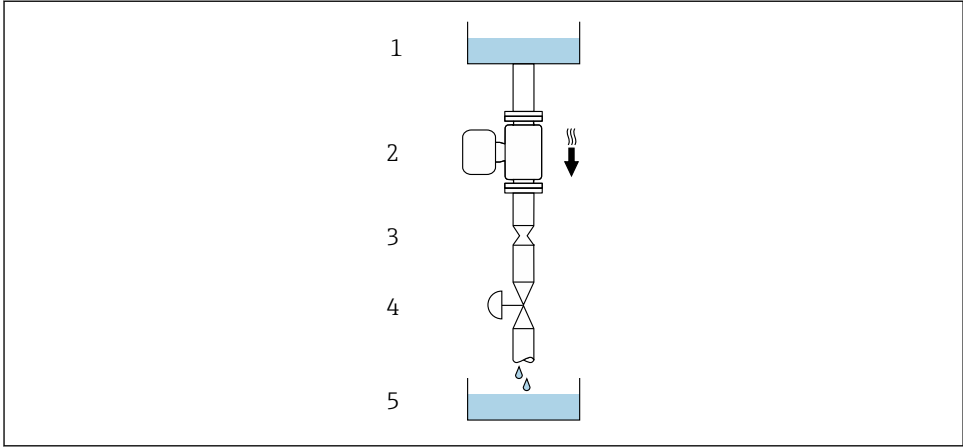

A0028773

2 Installation in a down pipe (e.g. for batching applications)

- 1 Supply tank
- 2 Sensor
- 3 Orifice plate, pipe restriction
- 4 Valve
- 5 Batching tank

DN		Ø orifice plate, pipe restriction	
[mm]	[in]	[mm]	[in]
8	3/8	6	0.24
15	1/2	10	0.40
15 FB	1/2 FB	15	0.60
25	1	14	0.55
25 FB	1 FB	24	0.95
40	1 1/2	22	0.87
40 FB	1 1/2 FB	35	1.38
50	2	28	1.10
50 FB	2 FB	54	2.13
80	3	50	1.97

FB = Full bore

**Orientation**

The direction of the arrow on the sensor nameplate helps you to install the sensor according to the flow direction.

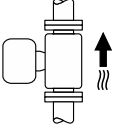
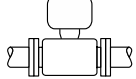
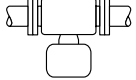
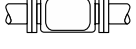
Orientation			Recommendation
A	Vertical orientation	 A0015591	☑☑☑ <sup>1)</sup> ☑☑
B	Horizontal orientation, transmitter at top	 A0015589	☑☑☑ <sup>2)</sup>
C	Horizontal orientation, transmitter at bottom	 A0015590	☑☑☑ <sup>3)</sup>
D	Horizontal orientation, transmitter at side	 A0015592	☑☑

- 1) This orientation is recommended to ensure self-draining.
- 2) Applications with low process temperatures may reduce the ambient temperature. To maintain the minimum ambient temperature for the transmitter, this orientation is recommended.
- 3) Applications with high process temperatures may increase the ambient temperature. To maintain the maximum ambient temperature for the transmitter, this orientation is recommended.

### Inlet and outlet runs

No special precautions need to be taken for fittings which create turbulence, such as valves, elbows or T-pieces, as long as no cavitation occurs → 16.

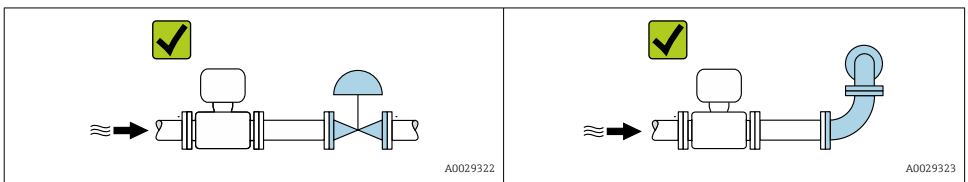

 For the dimensions and installed lengths of the device, see the "Technical Information" document, "Mechanical construction" section

### 5.1.2 Environmental and process requirements

#### Ambient temperature range

 For detailed information on the ambient temperature range, see the Operating Instructions for the device.

If operating outdoors:

- Install the measuring device in a shady location.
- Avoid direct sunlight, particularly in warm climatic regions.
- Avoid direct exposure to weather conditions.

### Temperature tables



For detailed information on the temperature tables, see the separate document entitled "Safety Instructions" (XA) for the device.

### System pressure

It is important that cavitation does not occur, or that gases entrained in the liquids do not outgas. This is prevented by means of a sufficiently high system pressure.

For this reason, the following mounting locations are recommended:

- At the lowest point in a vertical pipe
- Downstream from pumps (no danger of vacuum)

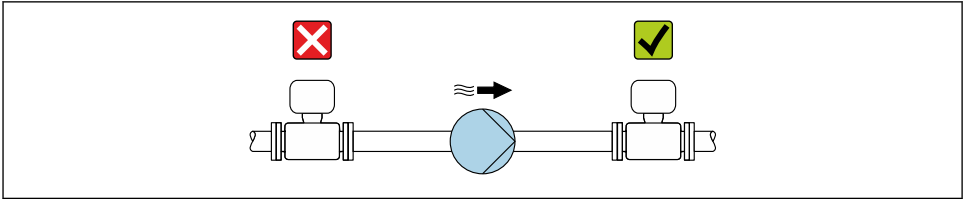

A0028777

### Thermal insulation

In the case of some fluids, it is important to keep the heat radiated from the sensor to the transmitter to a low level. A wide range of materials can be used for the required insulation.

The following device versions are recommended for versions with thermal insulation:

Version with extended neck for insulation (Promass 100, 300, 500):

Order code for "Sensor option", option CG with an extended neck length of 105 mm (4.13 in).

### NOTICE

#### Electronics overheating on account of thermal insulation!

- ▶ Recommended orientation: horizontal orientation, transmitter housing (Promass 100, 200, 300) or sensor connection housing (Promass 500) pointing downwards.
- ▶ Do not insulate the transmitter housing or connection housing of the sensor.
- ▶ Maximum permissible temperature at the lower end of the transmitter housing or connection housing of the sensor: 80 °C (176 °F)
- ▶ Thermal insulation with not isolated extended neck: We recommend that you do not insulate the extended neck in order to ensure optimum dissipation of heat.



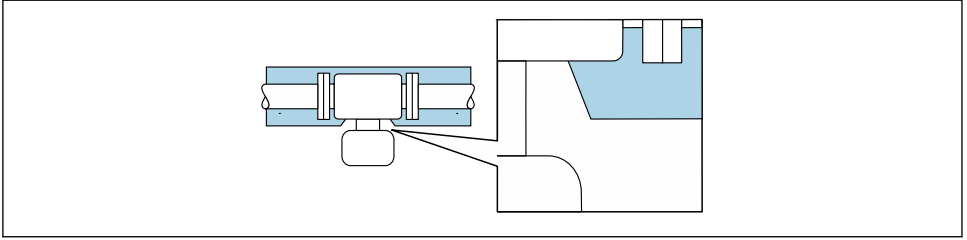

A0034391

### 3 Thermal insulation with not isolated extended neck

## Heating

### NOTICE

#### Electronics can overheat due to elevated ambient temperature!

- ▶ Observe maximum permitted ambient temperature for the transmitter.
- ▶ Depending on the medium temperature, take the device orientation requirements into account.

### NOTICE

#### Danger of overheating when heating

- ▶ Ensure that the temperature at the lower end of the transmitter housing does not exceed 80 °C (176 °F).
- ▶ Ensure that sufficient convection takes place at the transmitter neck.
- ▶ Ensure that a sufficiently large area of the transmitter neck remains exposed. The uncovered part serves as a radiator and protects the electronics from overheating and excessive cooling.
- ▶ When using in potentially explosive atmospheres, observe the information in the device-specific Ex documentation. For detailed information on the temperature tables, see the separate document entitled "Safety Instructions" (XA) for the device.

#### Heating options

If a fluid requires that no heat loss should occur at the sensor, users can avail of the following heating options:

- Electrical heating, e.g. with electric band heaters<sup>1)</sup>
- Via pipes carrying hot water or steam
- Via heating jackets



For detailed information on heating with electric band heaters, see the Operating Instructions for the device.

1) The use of parallel electric band heaters is generally recommended (bidirectional electricity flow). Particular considerations must be made if a single-wire heating cable is to be used. Additional information is provided in the document EA01339D "Installation instructions for electrical trace heating systems".

## Vibrations

The high oscillation frequency of the measuring tubes ensures that the correct operation of the measuring system is not influenced by plant vibrations.

### 5.1.3 Special mounting instructions

#### Drainability

When installed vertically, the measuring tube can be drained completely and protected against buildup.

When the sensor is installed in a horizontal line, eccentric clamps can be used to ensure complete drainability. When the system is pitched in a specific direction and at a specific slope, gravity can be used to achieve complete drainability. The sensor must be mounted in the correct position to ensure full drainability in the horizontal position. Markings on the sensor show the correct mounting position to optimize drainability.

*Promass I*

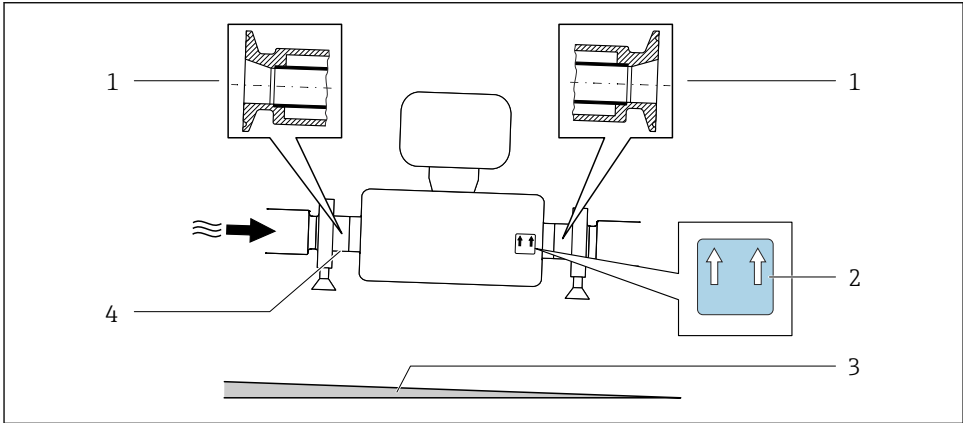

A0030297

- 1 Eccentric clamp connection
- 2 "This side up" label indicates which side is up
- 3 Slope the device in accordance with the hygiene guidelines. Slope: approx. 2 % or 21 mm/m (0.24 in/feet)
- 4 Line on the underside indicates the lowest point of the eccentric process connection.

#### Securing with mounting clamp in the case of hygiene connections

It is not necessary to provide additional support for the sensor for operational performance purposes. If, however, additional support is required for installation purposes, the following dimensions must be observed.

Use mounting clamp with lining between clamp and measuring instrument.

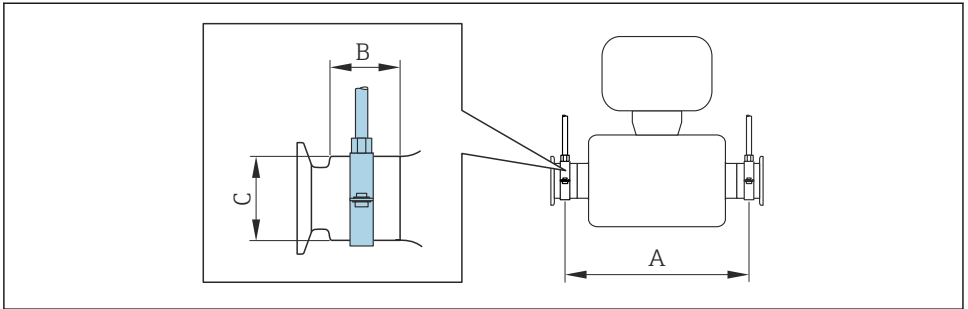

A0030298

DN		A		B		C	
[mm]	[in]	[mm]	[in]	[mm]	[in]	[mm]	[in]
8	8	373	14.69	20	0.79	40	1.57
15	15	409	16.1	20	0.79	40	1.57
15 FB	15 FB	539	21.22	30	1.18	44.5	1.75
25	25	539	21.22	30	1.18	44.5	1.75
25 FB	25 FB	668	26.3	28	1.1	60	2.36
40	40	668	26.3	28	1.1	60	2.36
40 FB	40 FB	780	30.71	35	1.38	80	3.15
50	50	780	30.71	35	1.38	80	3.15
50 FB	50 FB	1152	45.35	57	2.24	90	3.54
80	80	1152	45.35	57	2.24	90	3.54

### Zero point verification and zero adjustment

All measuring devices are calibrated in accordance with state-of-the-art technology. Calibration takes place under reference conditions. Therefore, a zero adjustment in the field is generally not required.

Experience shows that zero adjustment is advisable only in special cases:

- To achieve maximum measuring accuracy even with low flow rates.
- Under extreme process or operating conditions (e.g. very high process temperatures or very high-viscosity fluids).

For information on checking the zero point and performing a zero adjustment, see the Operating Instructions for the device.

## 5.2 Mounting the measuring device

### 5.2.1 Required tools

For flanges and other process connections, use an appropriate mounting tool

### 5.2.2 Preparing the measuring device

1. Remove all remaining transport packaging.
2. Remove any protective covers or protective caps present from the sensor.
3. Remove stick-on label on the electronics compartment cover.

### 5.2.3 Mounting the sensor



**WARNING**

#### Danger due to improper process sealing!

- ▶ Ensure that the inside diameters of the gaskets are greater than or equal to that of the process connections and piping.
- ▶ Ensure that the seals are clean and undamaged.
- ▶ Secure the seals correctly.

1. Ensure that the direction of the arrow on the nameplate of the sensor matches the flow direction of the medium.
2. Install the measuring device or turn the transmitter housing so that the cable entries do not point upwards.

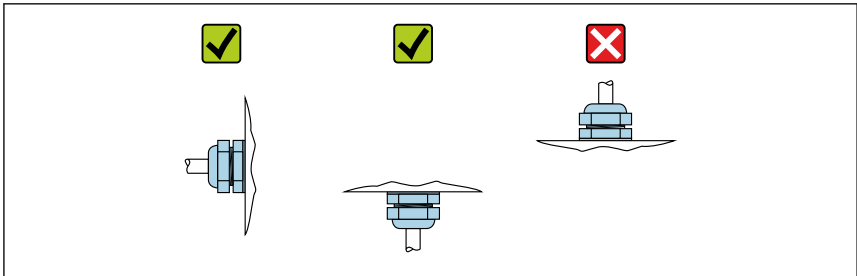

A0029263

## 5.3 Post-installation check

Is the device undamaged (visual inspection)?	<input type="checkbox"/>
Does the measuring device conform to the measuring point specifications? For example:	<input type="checkbox"/>
▪ Process temperature	
▪ Process pressure (refer to the section on "Pressure-temperature ratings" in the "Technical Information" document)	
▪ Ambient temperature ▪ Measuring range	
Has the correct orientation for the sensor been selected ?	<input type="checkbox"/>
▪ According to sensor type ▪ According to medium temperature ▪ According to medium properties (outgassing, with entrained solids)	
Does the arrow on the sensor nameplate match the direction of flow of the fluid through the piping →  14?	<input type="checkbox"/>
Are the measuring point identification and labeling correct (visual inspection)?	<input type="checkbox"/>

Is the device adequately protected from precipitation and direct sunlight?	<input type="checkbox"/>
Are the securing screw and securing clamp tightened securely?	<input type="checkbox"/>

## 6 Disposal



If required by the Directive 2012/19/EU on waste electrical and electronic equipment (WEEE), the product is marked with the depicted symbol in order to minimize the disposal of WEEE as unsorted municipal waste. Do not dispose of products bearing this marking as unsorted municipal waste. Instead, return them to the manufacturer for disposal under the applicable conditions.

### 6.1 Removing the measuring device

1. Switch off the device.

#### WARNING

#### **Danger to persons from process conditions!**

- ▶ Beware of hazardous process conditions such as pressure in the measuring device, high temperatures or aggressive fluids.

2. Carry out the mounting and connection steps from the "Mounting the measuring device" and "Connecting the measuring device" sections in reverse order. Observe the safety instructions.

### 6.2 Disposing of the measuring device

#### WARNING

#### **Danger to personnel and environment from fluids that are hazardous to health.**

- ▶ Ensure that the measuring device and all cavities are free of fluid residues that are hazardous to health or the environment, e.g. substances that have permeated into crevices or diffused through plastic.

Observe the following notes during disposal:

- ▶ Observe valid federal/national regulations.
- ▶ Ensure proper separation and reuse of the device components.







71574754

[www.addresses.endress.com](http://www.addresses.endress.com)

---