

Brief Operating Instructions Deltapilot M FMB50, FMB51, FMB52, FMB53

Hydrostatic level measurement

PROFIBUS PA

Pressure sensor with the CONTITITE™ measuring cell
(condensate-resistant)

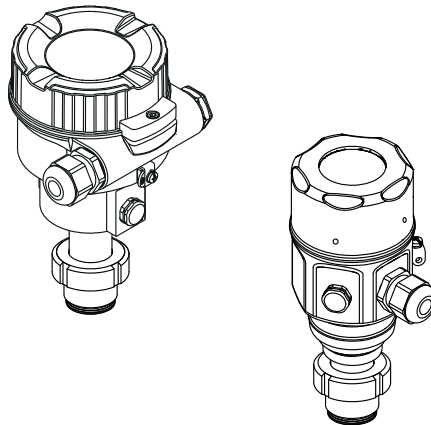

These Brief Operating Instructions are not a substitute for the Operating Instructions pertaining to the device.

Detailed information about the device can be found in the Operating Instructions and the additional documentation.

Available for all device versions via

- Internet: www.endress.com/deviceviewer
- Smartphone/tablet: *Endress+Hauser Operations app*

1 Associated documentation



A0023555

2 About this document

2.1 Document function

The Brief Operating Instructions contain all the essential information from incoming acceptance to initial commissioning.

2.2 Symbols used

2.2.1 Safety symbols

DANGER

This symbol alerts you to a dangerous situation. Failure to avoid this situation will result in serious or fatal injury.

WARNING

This symbol alerts you to a dangerous situation. Failure to avoid this situation can result in serious or fatal injury.

CAUTION

This symbol alerts you to a dangerous situation. Failure to avoid this situation can result in minor or medium injury.

NOTICE

This symbol contains information on procedures and other facts which do not result in personal injury.

2.2.2 Electrical symbols

Protective earth (PE)

Ground terminals that must be connected to ground prior to establishing any other connections.

The ground terminals are located on the interior and exterior of the device:

- Interior ground terminal: protective earth is connected to the mains supply.
- Exterior ground terminal: device is connected to the plant grounding system.

2.2.3 Symbols for certain types of information and graphics

Symbols for certain types of information and graphics

Permitted

Procedures, processes or actions that are permitted

Forbidden

Procedures, processes or actions that are forbidden

Tip

Indicates additional information



Reference to documentation



Reference to page



Visual inspection



Notice or individual step to be observed

1, 2, 3, ...

Item numbers

1, 2, 3

Series of steps



Result of a step

2.3 Registered trademarks

- KALREZ®
Registered label of E.I. Du Pont de Nemours & Co., Wilmington, USA
- TRI-CLAMP®
Registered label of Ladish & Co., Inc., Kenosha, USA
- PROFIBUS PA®
Trademark of the PROFIBUS User Organization, Karlsruhe, Germany
- GORE-TEX® trademark of W.L. Gore & Associates, Inc., USA

3 Basic safety instructions

3.1 Requirements for the personnel

Personnel must meet the following requirements for their tasks:

- ▶ Trained, qualified specialists must be suitably qualified to perform this function and task
- ▶ Are authorized by the plant owner/operator
- ▶ Are familiar with federal/national regulations
- ▶ They must have read and understood the instructions in the manual, supplementary documentation and certificates (depending on the application) prior to starting work
- ▶ They must follow instructions and comply with basic conditions

3.2 Intended use

The Deltapilot M is a hydrostatic pressure sensor for measuring level and pressure.

3.2.1 Foreseeable incorrect use

The manufacturer is not liable for damage caused by improper or non-intended use.

Verification for borderline cases:

- ▶ For special fluids and fluids for cleaning, Endress+Hauser is glad to provide assistance in verifying the corrosion resistance of fluid-wetted materials, but does not accept any warranty or liability.

3.3 Workplace safety

For work on and with the device:

- ▶ Wear the required personal protective equipment according to federal/national regulations.

- ▶ Switch off the supply voltage before connecting the device.

3.4 Operational safety

Risk of injury!

- ▶ Operate the device in proper technical condition and fail-safe condition only.
- ▶ The operator is responsible for interference-free operation of the device.

Conversions to the device

Unauthorized modifications to the device are not permitted and can lead to unforeseeable dangers:

- ▶ If, despite this, modifications are required, consult with Endress+Hauser.

Repair

To ensure continued operational safety and reliability:

- ▶ Carry out repairs on the device only if they are expressly permitted.
- ▶ Observe federal/national regulations pertaining to repair of an electrical device.
- ▶ Use original spare parts and accessories from Endress+Hauser only.

Hazardous area

To eliminate a danger for persons or for the facility when the device is used in the hazardous area (e.g. explosion protection, pressure vessel safety):

- ▶ Based on the nameplate, check whether the ordered device is permitted for the intended use in the hazardous area.
- ▶ Observe the specifications in the separate supplementary documentation that is an integral part of these Instructions.

3.5 Product safety

This measuring device is designed in accordance with good engineering practice to meet state-of-the-art safety requirements, has been tested, and left the factory in a condition in which they are safe to operate.

It fulfills general safety requirements and legal requirements. It also conforms to the EC directives listed in the device-specific EC declaration of conformity. Endress+Hauser confirms this fact by applying the CE mark.

4 Incoming acceptance and product identification

4.1 Incoming acceptance

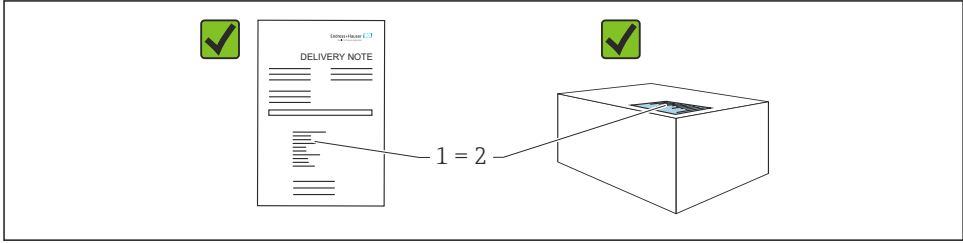

A0016870

- Is the order code on the delivery note (1) identical to the order code on the product sticker (2)?
- Are the goods undamaged?
- Do the data on the nameplate correspond to the order specifications and the delivery note?
- Is the documentation available?
- If required (see nameplate): Are the safety instructions (XA) present?



If one of these conditions is not fulfilled, please contact your Endress+Hauser sales office.

4.2 Storage and transport

4.2.1 Storage conditions

Use original packaging.

Store the measuring device in clean and dry conditions and protect from damage caused by shocks (EN 837-2).

4.2.2 Transporting the product to the measuring point

⚠ WARNING

Incorrect transport!

Housing and membrane may become damaged, and there is a risk of injury!

- ▶ Transport the measuring device to the measuring point in its original packaging or by the process connection.
- ▶ Follow the safety instructions and transport conditions for devices weighing more than 18 kg (39.6 lbs).

5 Mounting

5.1 Mounting requirements

5.1.1 General installation instructions

- Devices with a G 1 1/2 thread:
When screwing the device into the tank, the flat seal has to be positioned on the sealing surface of the process connection. To avoid additional strain on the process membrane, the thread should never be sealed with hemp or similar materials.
- Devices with NPT threads:
 - Wrap Teflon tape around the thread to seal it.
 - Tighten the device at the hexagonal bolt only. Do not turn at the housing.
 - Do not overtighten the thread when screwing. Max. tightening torque: 20 to 30 Nm (14.75 to 22.13 lbf ft)
- For the following process connections, a tightening torque of max. 40 Nm (29.50 lbf ft) is specified:
 - Thread ISO228 G1/2 (Order option "GRC" or "GRJ" or "GOJ")
 - Thread DIN13 M20 x 1.5 (Order option "G7J" or "G8J")

5.1.2 Mounting sensor modules with PVDF thread

WARNING

Risk of damage to process connection!

Risk of injury!

- ▶ Sensor modules with PVDF thread must be installed with the mounting bracket provided!

WARNING

Material fatigue from pressure and temperature!

Risk of injury if parts burst! The thread can become loose if exposed to high pressure and temperature loads.

- ▶ The integrity of the thread must be checked regularly. Also, the thread may need to be re-tightened with the maximum tightening torque of 7 Nm (5.16 lbf ft). Teflon tape is recommended for sealing the 1/2" NPT thread.

5.2 Mounting the device

5.2.1 General installation instructions

NOTICE

Damage to the device!

If a heated device is cooled during a cleaning process (e.g. by cold water), a vacuum develops for a short time and, as a result, moisture can enter the sensor via the pressure compensation (1).

- ▶ Mount the device as follows.

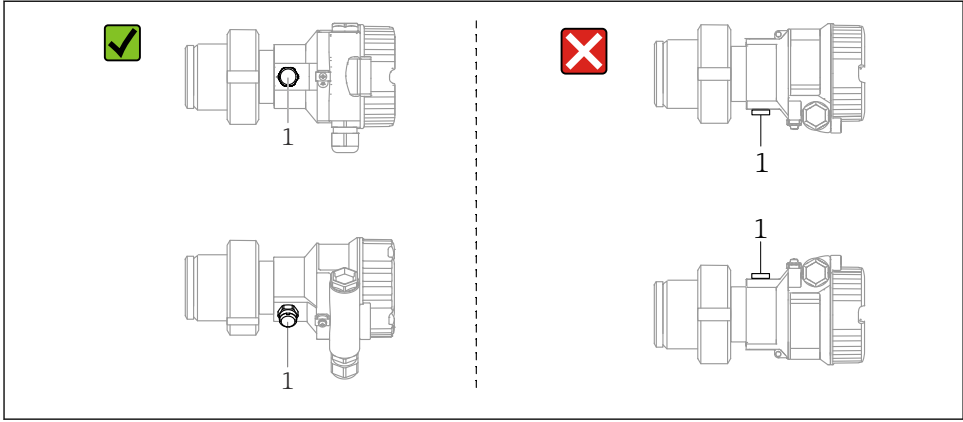

A0028471

- Keep the pressure compensation and GORE-TEX® filter (1) free from contamination.
- Do not clean or touch process membranes with hard or pointed objects.
- The process membrane in the rod and cable version is protected against mechanical damage by a plastic cap.
- The device must be installed as follows in order to comply with the cleanability requirements of the ASME-BPE (Part SD Cleanability):

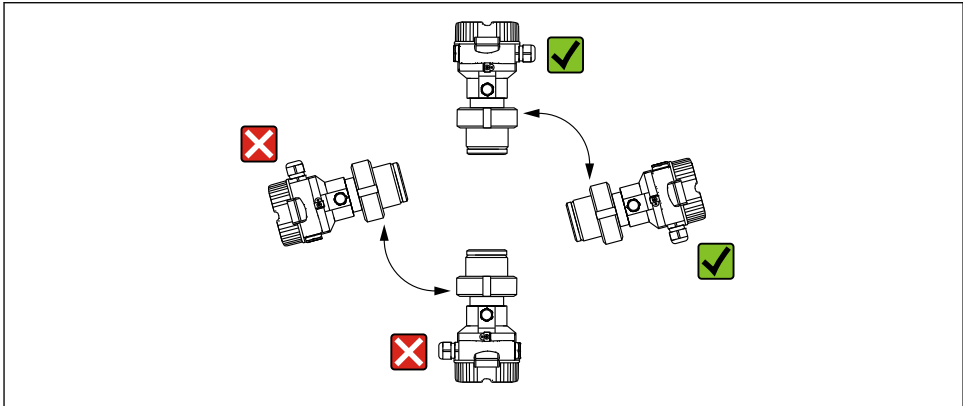

A0028472

5.2.2 FMB50

Level measurement

- Always install the device below the lowest measuring point.
- Do not install the device at the following positions:
 - in the filling curtain
 - in the tank outlet
 - in the suction area of a pump
 - at a point in the tank which could be affected by pressure pulses from the agitator.
- The calibration and functional test can be carried out more easily if you mount the device downstream from a shutoff device.
- The Deltapilot M must also be insulated in the case of media that can harden when cold.

Pressure measurement in gases

Mount the Deltapilot M with the shutoff device above the tapping point so that any condensate can flow into the process.

Pressure measurement in vapors

- Mount the Deltapilot M with the siphon above the tapping point.
- Fill the siphon with liquid before commissioning. The siphon reduces the temperature to almost ambient temperature.

Pressure measurement in liquids

Mount the Deltapilot M with the shutoff device below or at the same level as the tapping point.

5.2.3 FMB51/FMB52/FMB53

- When mounting rod and cable versions, make sure that the probe head is located at a point as free as possible from flow. To protect the probe from impact resulting from lateral movement, mount the probe in a guide tube (preferably made of plastic) or secure it with a clamping fixture.
- In the case of devices for hazardous areas, comply strictly with the safety instructions when the housing cover is open.
- The length of the extension cable or the probe rod is based on the planned level zero point. The height of the protective cap must be taken into consideration when designing the layout of the measuring point. The level zero point (E) corresponds to the position of the process isolating diaphragm.
Level zero point = E; top of the probe = L.

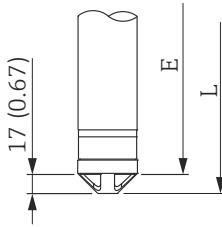

A0023559

5.2.4 Mounting the FMB53 with a suspension clamp

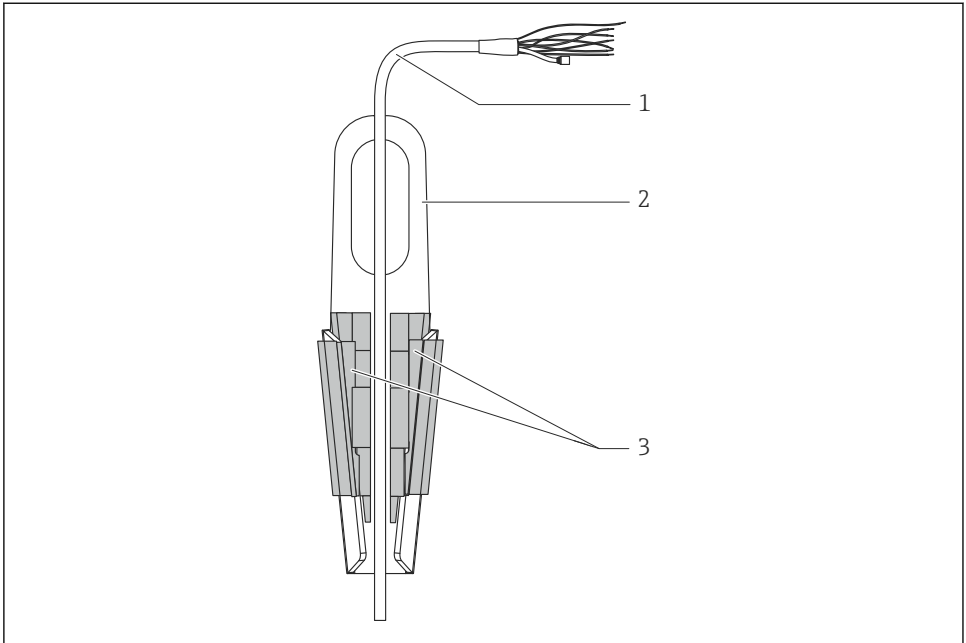

A0018793

- 1 Extension cable
- 2 Suspension clamp
- 3 Clamping jaws

Mounting the suspension clamp:

1. Mount the suspension clamp (item 2). When selecting the place to fix the unit, take the weight of the extension cable (item 1) and the device into account.
2. Raise the clamping jaws (item 3). Position the extension cable (item 1) between the clamping jaws as illustrated in Figure.
3. Hold the extension cable in position (item 1) and push the clamping jaws (item 3) back down. Tap the clamping jaws gently from above to fix them in place.

5.2.5 Supplementary installation instructions

Seal the probe housing

- No moisture may enter the housing when installing or operating the device, or when establishing the electrical connection.
- Always firmly tighten the housing cover and the cable entries.

5.2.6 Seal for flange mounting

NOTICE

Incorrect measurement results.

The seal is not allowed to press against the process membrane as this could affect the measurement result.

- ▶ Ensure that the seal is not touching the process membrane.

5.2.7 Closing the housing covers

NOTICE

Devices with EPDM cover seal - leaking transmitter!

Mineral-, animal- or plant-based lubricants cause the EPDM cover seal to swell and the transmitter to leak as a result.

- ▶ It is not necessary to grease the thread due to the coating applied to the thread at the factory.

NOTICE

The housing cover can no longer be closed.

Damaged thread!

- ▶ When closing the housing covers make sure that the threads on the covers and the housing are free from dirt, such as sand. If you encounter resistance when closing the covers, then check the threads again for dirt or fouling.

6 Electrical connection

6.1 Connecting requirements

6.1.1 Shielding/potential equalization

- You achieve optimum shielding against disturbances if the shielding is connected on both sides (in the cabinet and on the device). If potential equalization currents are expected in the plant, only ground shielding on one side, preferably at the transmitter.
- When using in hazardous areas, you must observe the applicable regulations. Separate Ex documentation with additional technical data and instructions is included with all Ex systems as standard. Connect all devices to the local potential equalization.

6.2 Connecting the device

WARNING

Supply voltage might be connected!

Risk of electric shock and/or explosion!

- ▶ Ensure that no uncontrolled processes are activated at the facility.
- ▶ Switch off the supply voltage before connecting the device.
- ▶ When using the measuring device in hazardous areas, installation must also comply with the applicable national standards and regulations and the Safety Instructions or Installation or Control Drawings.
- ▶ In accordance with IEC/EN61010 a suitable circuit breaker must be provided for the device.
- ▶ Devices with integrated overvoltage protection must be grounded.
- ▶ Protective circuits against reverse polarity, HF influences and overvoltage peaks are integrated.

Connect the device in the following order:

1. Check whether the supply voltage matches the supply voltage indicated on the nameplate.
2. Switch off the supply voltage before connecting the device.
3. Remove the housing cover.
4. Guide the cable through the gland. Preferably use a twisted, shielded two-wire cable.
5. Connect the device as indicated in the following diagram.
6. Screw down the housing cover.
7. Switch on the supply voltage.

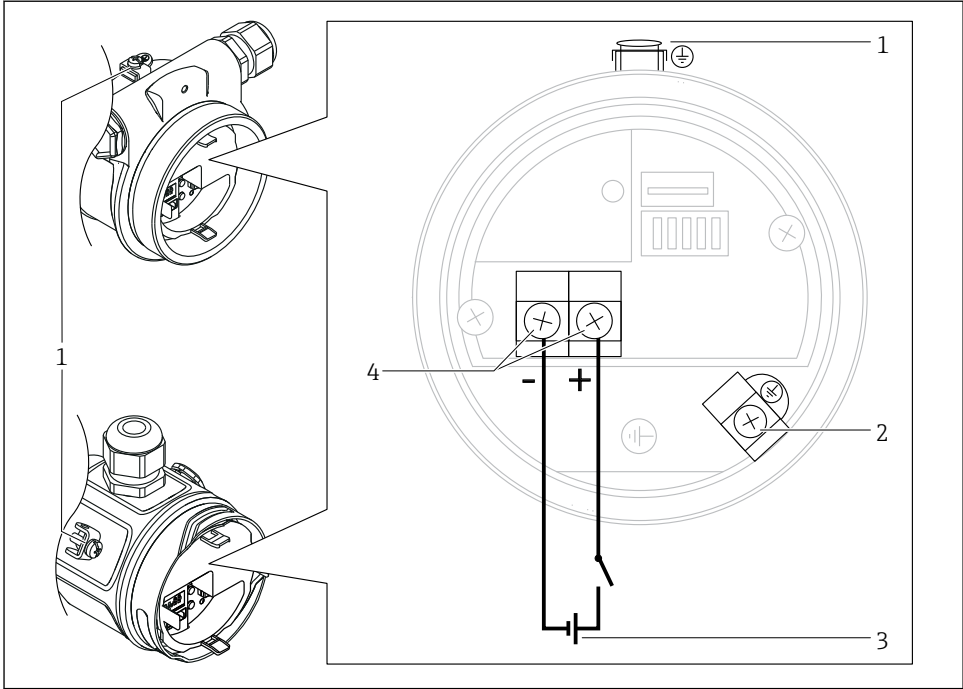

A0029967

- 1 External ground terminal
- 2 Grounding terminal
- 3 PROFIBUS PA: Supply voltage: 9...32 VDC (Segment coupler)
- 4 Terminals for supply voltage and signal

6.2.1 Connecting the cable version (FMB50 only)

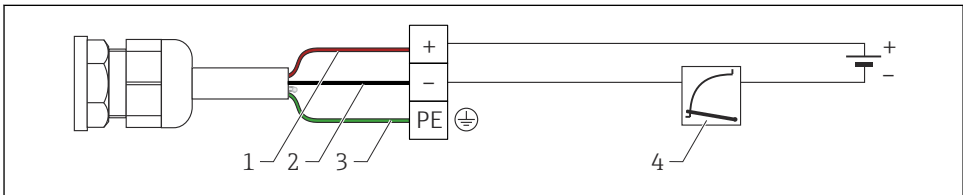

A0019991

- 1 RD = red
- 2 BK = black
- 3 GNYE = green
- 4 4 to 20 mA

6.2.2 Connection of devices with M12 plug

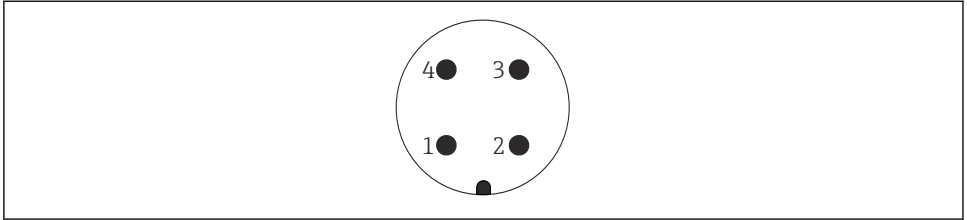

A0011175

- 1 *Signal +*
- 2 *Not assigned*
- 3 *Signal -*
- 4 *Ground*

6.2.3 Supply voltage

PROFIBUS PA

Version for non-hazardous areas: 9 to 32 V DC

6.2.4 Current consumption

11 mA \pm 1 mA, switch-on current corresponds to IEC 61158-2, Clause 21.

6.2.5 Terminals

- Supply voltage and internal ground terminal: 0.5 to 2.5 mm² (20 to 14 AWG)
- External ground terminal: 0.5 to 4 mm² (20 to 12 AWG)

6.2.6 Cable specification

PROFIBUS PA

- Use a twisted, shielded two-wire cable, preferably cable type A.
- Cable outer diameter: 5 to 9 mm (0.2 to 0.35 in) depending on the cable gland used



For further information on the cable specifications, see Operating Instructions BA00034S "PROFIBUS DP/PA: Guidelines for planning and commissioning", the PNO Guideline 2.092 "PROFIBUS PA User and Installation Guideline" and IEC 61158-2 (MBP).

7 Operation options

7.1 Operation without an operating menu

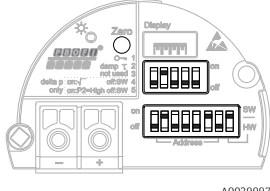
Operation options	Explanation	Graphic	Description
Local operation without device display	The device is operated using the operating keys and the DIP switches on the electronic insert.		→ 16

7.1.1 Position of operating elements

The operating key and DIP switches are located on the electronic insert in the device.

PROFIBUS PA

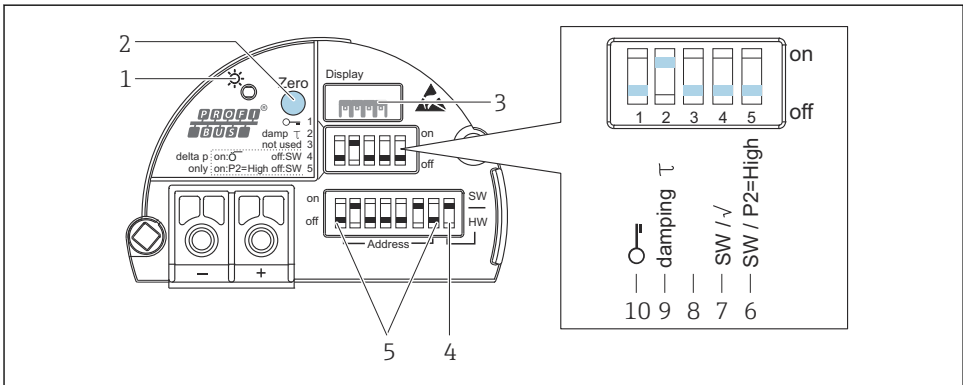

A0032659

- 1 Green LED to indicate successful operation
- 2 Operating key for position zero adjustment (Zero) or reset
- 3 Slot for optional local display
- 4 DIP-switch for bus address SW / HW
- 5 DIP-switch for hardware address
- 6 DIP switch only for Deltabar M
- 7 DIP switch only for Deltabar M
- 8 Not used
- 9 DIP switch for switching damping on/off
- 10 DIP switch for locking/unlocking parameters relevant to the measured value

Function of the DIP switches

Symbol/labeling	Switch position	
	"off"	"on"
 A0011978	The device is unlocked. Parameters relevant to the measured value can be modified.	The device is locked. Parameters relevant to the measured value cannot be modified.
damping τ	Damping is switched off. The output signal follows measured value changes without any delay.	Damping is switched on. The output signal follows measured value changes with the delay time τ . ¹⁾
Address	Set the device address using switches 1-7	
SW / HW	Hardware addressing	Software addressing

- 1) The value for the delay time can be configured via the operating menu ("Setup" → "Damping"). Factory setting: $\tau = 2$ s or as per order specifications.

Function of the operating elements

Key	Meaning
Zero pressed for at least 3 seconds	Position adjustment Press key for at least 3 seconds. The LED on the electronic insert lights up briefly if the pressure applied has been accepted for position adjustment. See also the following Section "Performing position adjustment on site."
Zero pressed for at least 12 seconds	Reset All the parameters are reset to the order configuration.

Performing position adjustment on site

- Operation must be unlocked.
- The device is configured for the "Pressure" measuring mode (Cerabar, Deltabar) or "Level" measuring mode (Deltapilot) as standard.
- The pressure applied must be within the nominal pressure limits of the sensor. See information on the nameplate.

Perform position adjustment:

1. Pressure is present at the device.
2. Press key for at least 3 seconds.
3. If the LED on the electronic insert lights up briefly, the pressure applied has been accepted for position adjustment. If the LED does not light up, the pressure applied was not accepted. Observe the input limits. For error messages see the Operating Instructions.

7.2 Operation with device display (optional)

A 4-line liquid crystal display (LCD) is used for display and operation. The local display shows measured values, dialog texts, fault messages and notice messages. For easy operation the display can be taken out of the housing (see figure steps 1 to 3). It is connected to the device via a cable that is 90 mm (3.54 in) long. The display of the device can be turned in 90° stages (see figure steps 4 to 6). Depending on the installation position of the device, this makes it easy to operate the device and read the measured values.

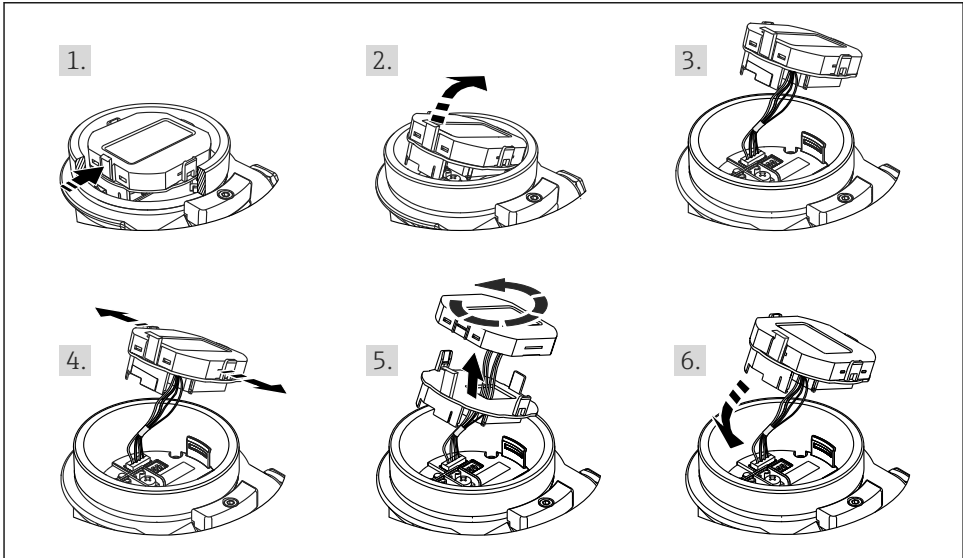

A0028500

Functions:



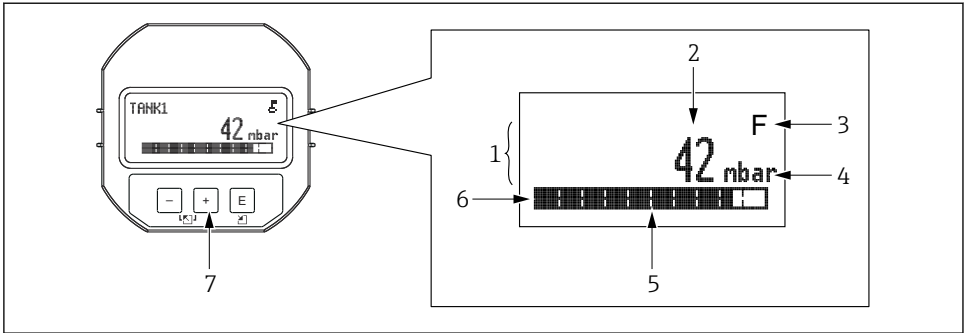



- 8-digit measured value display including sign and decimal point.
- Bar graph as graphic display of the standardized value of the Analog Input Block ("Scaling the output value (OUT Value)", figure)
- Three keys for operation
- Simple and complete menu guidance due to breakdown of parameters into several levels and groups
- Each parameter is given a 3-digit parameter code for easy navigation
- Possibility of configuring the display to suit individual requirements and preferences, e.g. language, alternating display, display of other measured values such as sensor temperature, contrast setting
- Comprehensive diagnostic functions (fault and warning message etc.)











A0030013

- 1 Main line
- 2 Value
- 3 Symbol
- 4 Unit
- 5 Bar graph
- 6 Information line
- 7 Operating keys

The following table illustrates the symbols that can appear on the local display. Four symbols may appear at the same time.





Symbol	Meaning
 A0018154	Lock symbol The operation of the device is locked. Unlock the device, .
 A0018155	Communication symbol Data transfer via communication
 A0013958	Error message "Out of specification" The device is being operated outside its technical specifications (e.g. during startup or cleaning).
 A0013959	Error message "Service mode" The device is in the service mode (e.g. during a simulation).
 A0013957	Error message "Maintenance required" Maintenance is required. The measured value remains valid.
 A0013956	Error message "Failure detected" An operating error has occurred. The measured value is no longer valid.

7.2.1 Operating keys on the display and operating module

Operating key(s)	Meaning
 A0017879	<ul style="list-style-type: none"> Navigate down in the picklist Edit the numerical values or characters within a function
 A0017880	<ul style="list-style-type: none"> Navigate up in the picklist Edit the numerical values or characters within a function
 A0017881	<ul style="list-style-type: none"> Confirm entry Jump to the next item Select a menu item and activate the edit mode
 and  A0017879 and A0017881	Contrast setting of local display: darker
 and  A0017880 and A0017881	Contrast setting of local display: brighter
 and  A0017879 and A0017880	<p>ESC functions:</p> <ul style="list-style-type: none"> Exit edit mode for a parameter without saving the changed value You are in a menu at a selection level. Each time you press the keys simultaneously, you go up a level in the menu.

7.2.2 Operating example: Parameters with a picklist

Example: selecting "Deutsch" as the language of the menu.

Language	000	Operation
1	<ul style="list-style-type: none"> English Deutsch 	<p>"English" is set as the menu language (default value). A ✓ in front of the menu text indicates the option that is currently active.</p>
2	<ul style="list-style-type: none"> Deutsch ✓ English 	Select "Deutsch" with  or  .
3	<ul style="list-style-type: none"> ✓ Deutsch English 	<ul style="list-style-type: none"> Select  to confirm. A ✓ in front of the menu text indicates the active option ("Deutsch" is now selected as the menu language). Use  to exit the edit mode for the parameter.

7.2.3 Operating example: User-definable parameters

Example: Setting the "Set URV (014)" parameter from 100 mbar (1.5 psi) to 50 mbar (0.75 psi).

Menu path: Setup → Extended setup → Current output → Set URV

	Set URV	014	Operation
1		mbar	The local display shows the parameter to be changed. The "mbar" unit is defined in another parameter and cannot be changed here.
2		mbar	Press or to enter the edit mode. The first digit is highlighted in black.
3		mbar	Use the key to change "1" to "5". Press the key to confirm "5". The cursor jumps to the next position (highlighted in black). Confirm "0" with (second position).
4		mbar	The third digit is highlighted in black and can now be edited.
5		mbar	Use the key to change to the "←" symbol. Use to save the new value and exit the edit mode. See next graphic.
6		mbar	The new value for the upper range value is 50 mbar (0.75 psi). Use to exit the edit mode for the parameter. Use or to return to the edit mode.

7.2.4 Operating example: Accepting the pressure present

Example: Setting position adjustment.

Menu path: Main menu → Setup → Position adjustment

	Position adjustment	007	Operation
1	✓ Cancel Confirm		The pressure for position adjustment is present at the device.
2	Cancel ✓ Confirm		Use or to switch to the "Confirm" option. The active option is highlighted in black.
3	Adjustment has been accepted!		Use the key to accept the applied pressure for position adjustment. The device confirms the adjustment and goes back to the "Position adjustment" parameter.
4	✓ Cancel Confirm		Use to exit the edit mode for the parameter.

8 Commissioning

The device is configured for the "Level" measuring mode as standard.

The measuring range and the unit in which the measured value is transmitted correspond to the data on the nameplate.

⚠ WARNING

The permitted process pressure is exceeded!

Risk of injury if parts burst! Warnings are displayed if the pressure is too high.

- ▶ If a pressure smaller than the minimum permitted pressure or greater than the maximum permitted pressure is present at the device, the following messages are output in succession (depending on the setting in the "Alarm behavior" (050) parameter): "S140 Working range P" or "F140 Working range P" "S841 Sensor range" or "F841 Sensor range" "S971 Adjustment"
- ▶ Only use the device within the sensor range limits!

NOTICE

The permitted process pressure is undershot!



Messages are displayed if the pressure is too low.

- ▶ If a pressure smaller than the minimum permitted pressure or greater than the maximum permitted pressure is present at the device, the following messages are output in succession (depending on the setting in the "Alarm behavior" (050) parameter): "S140 Working range P" or "F140 Working range P" "S841 Sensor range" or "F841 Sensor range" "S971 Adjustment"
- ▶ Only use the device within the sensor range limits!

8.1 Commissioning with an operating menu

8.1.1 Selecting the language, measuring mode and pressure unit

Language (000)

Navigation	  Main menu → Language
Write permission	Operator/Maintenance/Expert
Description	Select the menu language for the local display.
Selection	<ul style="list-style-type: none"> ■ English ■ Another language (as selected when ordering the device) ■ A third language where applicable (language of the place of manufacture)
Factory setting	English

Press. eng. unit (125)

Write permission	Operator/Maintenance/Expert
Description	Select the pressure unit. If a new pressure unit is selected, all pressure-specific parameters are converted and displayed with the new unit.
Selection	<ul style="list-style-type: none"> ▪ mbar, bar ▪ mmH2O, mH2O ▪ inH2O, ftH2O ▪ Pa, kPa, MPa ▪ psi ▪ mmHg, inHg ▪ kgf/cm²
Factory setting	mbar or bar depending on the nominal measuring range of the sensor, or as per order specifications.

8.1.2 Position adjustment

Corrected press. (172)

Navigation	 Setup → Corrected press.
Write permission	Operator/Maintenance/Expert
Description	Displays the measured pressure after sensor trim and position adjustment.
Note	If this value is not equal to "0", it can be corrected to "0" by the position adjustment.

Pos. zero adjust (007) (gauge pressure sensors)

Write permission	Operator/Maintenance/Expert
-------------------------	-----------------------------

Description	Pos. zero adjustment – the pressure difference between zero (set point) and the measured pressure need not be known.
Example	<ul style="list-style-type: none"> ■ Measured value = 2.2 mbar (0.033 psi) ■ You correct the measured value via the "Pos. zero adjust" parameter with the "Confirm" option. This means that you are assigning the value 0.0 to the pressure present. ■ Measured value (after pos. zero adjustment) = 0.0 mbar ■ The current value is also corrected.
Selection	<ul style="list-style-type: none"> ■ Confirm ■ Cancel
Factory setting	Cancel

Calib. offset (192) / (008) (absolute pressure sensor)

Write permission	Maintenance/Expert
Description	Position adjustment – the pressure difference between the set point and the measured pressure must be known.
Example	<ul style="list-style-type: none"> ■ Measured value = 982.2 mbar (14.73 psi) ■ You correct the measured value with the value entered, e.g. 2.2 mbar (0.033 psi) via the "Calib. offset" parameter. This means that you are assigning the value to the pressure present 980.0 mbar (14.7 psi). ■ Measured value (after pos. zero adjustment) = 980.0 mbar (14.7 psi) ■ The current value is also corrected.
Factory setting	0.0

8.2 Configuring pressure measurement

8.2.1 Calibration without reference pressure (dry calibration)

Example:

In this example, a device with a 400 mbar (6 psi) sensor is configured for the 0 to +300 mbar (0 to 4.5 psi) measuring range, i.e. are assigned 0 mbar and 300 mbar (4.5 psi) respectively.

Prerequisite:

This is a theoretical calibration, i.e. the pressure values for the lower and upper range are known.



Due to the orientation of the device, there may be pressure shifts in the measured value, i.e. the measured value is not zero in an unpressurized state. For information on how to perform position adjustment, see → 22.

	Description
1	Select the "Pressure" measuring mode via the "Measuring mode" parameter. Menu path: Setup → Measuring mode  WARNING Changing the measuring mode affects the span (URV) This situation can result in product overflow. <ul style="list-style-type: none"> ▶ If the measuring mode is changed, the setting for the span (URV) must be checked in the "Setup" operating menu and readjusted if necessary.
2	Select a pressure unit via the "Press. eng. unit" parameter, here "mbar" for example. Menu path: Setup → Press. eng. unit
3	If necessary, scale the "OUT Value" of the Analog Input Block, , parameter descriptions for "Measured value scaling" and "Output scaling".
4	Result: The measuring range is configured for 0 to +300 mbar (0 to 4.5 psi).



71549534

www.addresses.endress.com
