

Operating Instructions

Memosens COL37E

Agile, optical oxygen sensor for laboratory measurements and random sampling in the field
Digital with Memosens 2.0 technology



Table of contents

- 1 About this document 4**
 - 1.1 Warnings 4
 - 1.2 Symbols used 4
 - 1.3 Documentation 5

- 2 Basic safety instructions 5**
 - 2.1 Requirements for the personnel 5
 - 2.2 Intended use 5
 - 2.3 Workplace safety 6
 - 2.4 Operational safety 6
 - 2.5 Product safety 6

- 3 Incoming acceptance and product identification 7**
 - 3.1 Incoming acceptance 7
 - 3.2 Product identification 7
 - 3.3 Scope of delivery 8

- 4 Electrical connection 8**
 - 4.1 Connection to handheld device 8
 - 4.2 Connection to handheld device via M12 cable 9

- 5 Commissioning 9**
 - 5.1 Calibration and adjustment 9

- 6 Maintenance 11**
 - 6.1 Maintenance tasks 11





- 7 Repair 12**
 - 7.1 General information 12
 - 7.2 Return 12
 - 7.3 Spare parts and consumables 12
 - 7.4 Disposal 12

- 8 Accessories 13**
 - 8.1 Device-specific accessories 13







- 9 Technical data 14**
 - 9.1 Input 14
 - 9.2 Performance characteristics 14
 - 9.3 Environment 15
 - 9.4 Process 15
 - 9.5 Mechanical construction 15

1 About this document



1.1 Warnings

Structure of information	Meaning
 <p>Causes (/consequences) If necessary, Consequences of non-compliance (if applicable)</p> <ul style="list-style-type: none"> ▶ Corrective action 	<p>This symbol alerts you to a dangerous situation. Failure to avoid the dangerous situation will result in a fatal or serious injury.</p>
 <p>Causes (/consequences) If necessary, Consequences of non-compliance (if applicable)</p> <ul style="list-style-type: none"> ▶ Corrective action 	<p>This symbol alerts you to a dangerous situation. Failure to avoid the dangerous situation can result in a fatal or serious injury.</p>
 <p>Causes (/consequences) If necessary, Consequences of non-compliance (if applicable)</p> <ul style="list-style-type: none"> ▶ Corrective action 	<p>This symbol alerts you to a dangerous situation. Failure to avoid this situation can result in minor or more serious injuries.</p>
 <p>Cause/situation If necessary, Consequences of non-compliance (if applicable)</p> <ul style="list-style-type: none"> ▶ Action/note 	<p>This symbol alerts you to situations which may result in damage to property.</p>

1.2 Symbols used

Symbol	Meaning
	Additional information, tips
	Permitted or recommended
	Not permitted or not recommended
	Reference to device documentation
	Reference to page
	Reference to graphic
	Result of a step

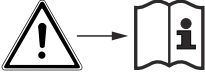
1.2.1 Symbols on the device

Symbol	Meaning
	Reference to device documentation
	Do not dispose of products bearing this marking as unsorted municipal waste. Instead, return them to the manufacturer for disposal under the applicable conditions.

1.3 Documentation

The following manuals, which complement these Operating Instructions, can be found on the product pages on the Internet:



Technical Information Memosens COL37E, TI01678C



Operating Instructions Liquiline Mobile CML18, BA02002C



Operating Instructions Memobase Plus CYZ71D, BA00502C

2 Basic safety instructions

2.1 Requirements for the personnel

- Installation, commissioning, operation and maintenance of the measuring system may be carried out only by specially trained technical personnel.
- The technical personnel must be authorized by the plant operator to carry out the specified activities.
- The electrical connection may be performed only by an electrical technician.
- The technical personnel must have read and understood these Operating Instructions and must follow the instructions contained therein.
- Faults at the measuring point may only be rectified by authorized and specially trained personnel.



Repairs not described in the Operating Instructions provided must be carried out only directly at the manufacturer's site or by the service organization.

2.2 Intended use

The COL37E oxygen sensor is designed for short-term measurement in laboratory or field environments.

The oxygen sensor is not intended for continuous measurements and for fixed installation in the process or in assemblies.

NOTICE**Halogen-containing solvents, ketones and toluene**

Halogen-containing solvents (dichloromethane, chloroform), ketones (e.g. acetone, pentanone) and toluene have a cross-sensitive effect and result in decreased measured values or, at worst, in the complete failure of the sensor!

- ▶ Use the sensor only in media that are free from halogens, ketones and toluene.

Use of the device for any purpose other than that described, poses a threat to the safety of people and of the entire measuring system and is therefore not permitted.

The manufacturer is not liable for damage caused by improper or non-designated use.

2.3 Workplace safety

As the user, you are responsible for complying with the following safety conditions:

- Installation specifications
- Local standards and regulations

2.4 Operational safety

Before commissioning the entire measuring point:

1. Verify that all connections are correct.
2. Ensure that electrical cables and hose connections are undamaged.
3. Do not operate damaged products, and protect them against unintentional operation.
4. Label damaged products as defective.

During operation:

- ▶ If faults cannot be rectified:
products must be taken out of service and protected against unintentional operation.

2.5 Product safety

2.5.1 State-of-the-art technology

The product is designed to meet state-of-the-art safety requirements, has been tested, and left the factory in a condition in which it is safe to operate. The relevant regulations and international standards have been observed.

3 Incoming acceptance and product identification

3.1 Incoming acceptance

1. Verify that the packaging is undamaged.
 - ↳ Notify the supplier of any damage to the packaging.
Keep the damaged packaging until the issue has been resolved.
2. Verify that the contents are undamaged.
 - ↳ Notify the supplier of any damage to the delivery contents.
Keep the damaged goods until the issue has been resolved.
3. Check that the delivery is complete and nothing is missing.
 - ↳ Compare the shipping documents with your order.
4. Pack the product for storage and transportation in such a way that it is protected against impact and moisture.
 - ↳ The original packaging offers the best protection.
Make sure to comply with the permitted ambient conditions.

If you have any questions, please contact your supplier or your local Sales Center.

3.2 Product identification

3.2.1 Nameplate

The following information about the device appears on the nameplate:

- Manufacturer identification
- Order ID
- Extended order code
- Serial number

▶ Compare the information on the nameplate with the order.

3.2.2 Product identification

Product page

www.endress.com/col37e

Interpreting the order code

The order code and serial number of your product can be found in the following locations:

- On the nameplate
- In the delivery papers

Obtaining information on the product

1. Open www.endress.com.
2. Call up the site search (magnifying glass).
3. Enter a valid serial number.

4. Search.

↳ The product structure is displayed in a popup window.

5. Click on the product image in the popup window.

↳ A new window (**Device Viewer**) opens. All of the information relating to your device is displayed in this window as well as the product documentation.

3.2.3 Manufacturer address

Endress+Hauser Conducta GmbH+Co. KG
 Dieselstraße 24
 D-70839 Gerlingen

3.3 Scope of delivery

The scope of delivery comprises:

- 1 sensor, version as ordered
- 1 x Operating Instructions

4 Electrical connection

4.1 Connection to handheld device

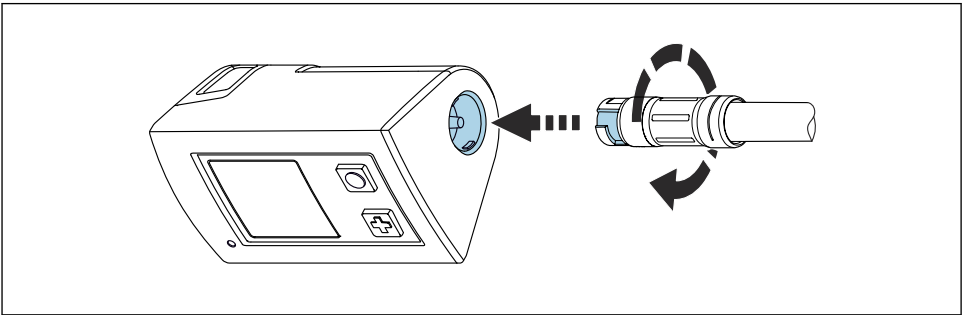

A00s1682

1 Sensor connection

1. Insert the sensor into the Memosens connection.
2. Turn the plug-in head of the sensor until it locks into place.

4.2 Connection to handheld device via M12 cable

1.

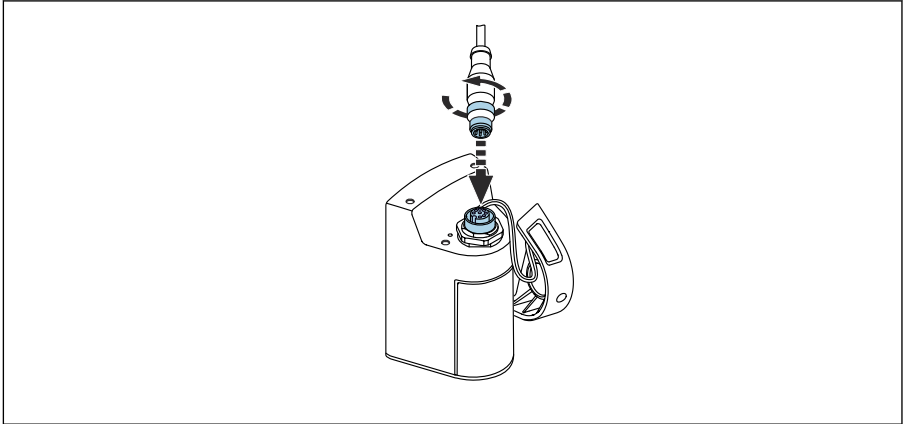

A0041681

Connect the M12 cable to the handheld device.

2.

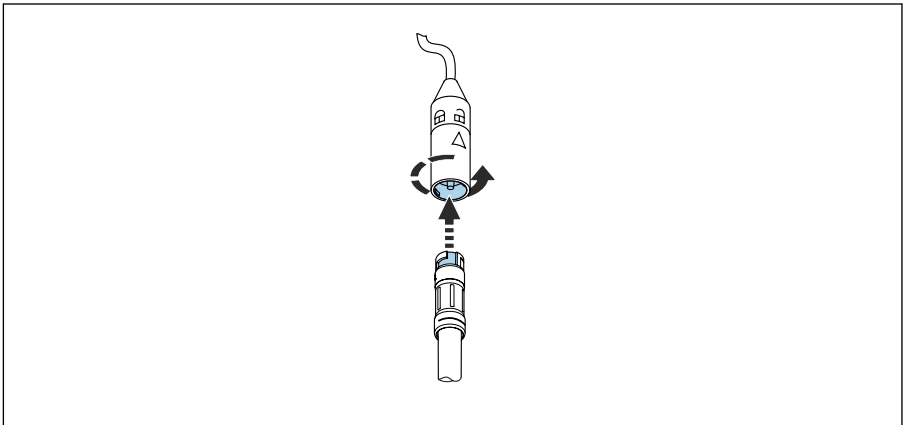

A0041680

Insert the sensor into the Memosens connection of the M12 cable and lock into place.

5 Commissioning

5.1 Calibration and adjustment

The sensor is calibrated and adjusted in the factory prior to delivery and is therefore ready for immediate use.

Refer to Operating Instructions BA02002C on the product page (www.endress.com/cml18) for the measurement, calibration and adjustment of the sensor on the Liquiline Mobile CML18.

Recommended procedure after replacing a spot cap

First calibrate and adjust the sensor at the zero point and then in the presence of oxygen.

5.1.1 Zero point calibration

The zero point is not so important when working with relatively high concentrations of oxygen. In these types of application, a zero point calibration is required only after the spot cap has been replaced.

However, once oxygen sensors are used at low concentrations and in the trace range, they must also be calibrated at the zero point.

Zero point calibrations are demanding as the ambient medium - usually air - already has a high oxygen content. This oxygen must be excluded for zero point calibration of the sensor.

A calibration with the COY8 zero-point gel can be used for this purpose:

The COY8 oxygen-depleting gel creates an oxygen-free medium for zero point calibration.

Prior to sensor zero point calibration, check the following:

- Is the sensor signal stable?
- Has the adjustment time of 30 min - 40 min for the COY8 zero-point gel elapsed?
- Is the value displayed plausible?

1. If the sensor signal is stable:
Calibrate the zero point.
2. If necessary:
Adjust the sensor by accepting the calibration data.

 If the oxygen sensor is calibrated too early, this can result in an incorrect zero point.

Rule of thumb: operate the sensor for at least 30 min in the zero-point gel.

 Follow the instructions in the kit documentation enclosed with the COY8 zero-point gel.

5.1.2 Calibration in air with 100% rH

1. Remove the sensor from the medium.
2. Clean the outside of the sensor carefully with a damp cloth.
3. Suspend the sensor just above the surface of the water. Use the calibration bottle provided for this purpose.
Do not immerse the sensor.
4. Allow a temperature compensation time of approx. 20 minutes for the sensor in the ambient air. Make sure that the sensor is not exposed to any direct ambient effects (direct sunlight, drafts) during this time.

- 5. Is the measured value display on the transmitter stable:
 Perform the calibration in accordance with the Operating Instructions for the transmitter. Pay particular attention to the software settings for the stability criteria for calibration and for the ambient pressure.
- i** The constants K_{sv} and τ_0 of the Stern-Volmer equation are determined at both calibration points (point in oxygen and zero point). The calibration quality index provides an indication of the quality of the calibration in relation to the first reference calibration of the spot cap. Therefore it is important to run the **Change sensor cap** command in the calibration menu of the transmitter before every initial calibration of a spot cap.

6 Maintenance

Take all the necessary precautions in time to ensure operational safety.

6.1 Maintenance tasks

6.1.1 Cleaning of sensor

Dirt on the sensor can impact the measurement and even cause a malfunction. Examples include buildup on the spot cap, which can cause a longer response time.

The sensor must be cleaned at regular intervals for reliable measurement results. The frequency and intensity of the cleaning process depend on the medium.

Clean the sensor:

- Before every calibration
- At regular intervals during operation as necessary
- Before returning it for repair

Type of contamination	Cleaning
Salt deposits	<ol style="list-style-type: none"> 1. Immerse the sensor in drinking water. 2. Then rinse it with copious amounts of water.
Dirt particles on the sensor shaft and shaft sleeve (not spot cap!)	▶ Clean sensor shaft and sleeve with water and a suitable sponge.
Dirt particles on the spot cap	▶ Clean the spot cap with water. No mechanical cleaning.

- ▶ After cleaning:
 Rinse with copious amounts of clean water.

7 Repair

7.1 General information

- ▶ Only use spare parts from Endress + Hauser to guarantee the safe and stable functioning of the device.

Detailed information on the spare parts is available at:

www.endress.com/device-viewer

7.2 Return

The product must be returned if repairs or a factory calibration are required, or if the wrong product was ordered or delivered. As an ISO-certified company and also due to legal regulations, Endress+Hauser is obliged to follow certain procedures when handling any returned products that have been in contact with medium.

To ensure the swift, safe and professional return of the device:

- ▶ Refer to the website www.endress.com/support/return-material for information on the procedure and conditions for returning devices.

The product must be returned if repairs or a factory calibration are required, or if the wrong product was ordered or delivered.

To ensure safe, professional and swift product returns, please contact your local Sales Center for information on the procedure to be followed and general conditions.

7.3 Spare parts and consumables

- Maintenance kit for Memosens COL37E
- Scope of delivery of the:
 - Spot cap
 - O-ring mounting tool
 - Maintenance instructions
 - Calibration bottle
 - O-rings
 - Certificate
- Ordering information: www.endress.com/col37e under "Accessories/spare parts"

7.4 Disposal



If required by the Directive 2012/19/EU on waste electrical and electronic equipment (WEEE), the product is marked with the depicted symbol in order to minimize the disposal of WEEE as unsorted municipal waste. Do not dispose of products bearing this marking as unsorted municipal waste. Instead, return them to Endress+Hauser for disposal under the applicable conditions.

8 Accessories

The following are the most important accessories available at the time this documentation was issued.

- ▶ For accessories not listed here, please contact your Service or Sales Center.

8.1 Device-specific accessories

8.1.1 Measuring cable

Memosens data cable CYK10

- For digital sensors with Memosens technology
- Product Configurator on the product page: www.endress.com/cyk10



Technical Information TI00118C

Memosens laboratory cable CYK20

- For digital sensors with Memosens technology
- Product Configurator on the product page: www.endress.com/cyk20

8.1.2 Zero-point gel

COY8

Zero-point gel for oxygen and disinfection sensors

- Oxygen-free and chlorine-free gel for the verification, zero point calibration and adjustment of oxygen and disinfection measuring points
- Product Configurator on the product page: www.endress.com/coy8



Technical Information TI01244C

8.1.3 Transmitter

Liquiline Mobile CML18

- Multiparameter mobile device for laboratory and field
- Reliable transmitter with display and app connection
- Product Configurator on the product page: www.endress.com/CML18



Operating Instructions BA02002C

Memobase Plus CYZ71D

- PC software to support laboratory calibration
- Visualization and documentation of sensor management
- Sensor calibrations stored in database
- Product Configurator on the product page: www.endress.com/cyz71d



Technical Information TI00502C

8.1.4 Maintenance kit

- Maintenance kit for Memosens COL37E
- Scope of delivery of the:
 - Spot cap
 - O-ring mounting tool
 - Maintenance instructions
 - Calibration bottle
 - O-rings
 - Certificate
- Ordering information: www.endress.com/col37e under "Accessories/spare parts"

9 Technical data

9.1 Input

9.1.1 Measured variables

Dissolved oxygen [mg/l, µg/l, ppm, ppb, %SAT or hPa]

Oxygen (gaseous) [hPa or %Vol]

Temperature [°C, °F]

9.1.2 measuring range

0 to 200 % SAT

Measuring ranges apply for 25 °C (77 °F) and 1013 hPa (15 psi)



The sensor has a measuring range of up to max. 1000 hPa.

The measured errors indicated are reached in the optimum measuring range, but not over the entire measuring range.

9.2 Performance characteristics

9.2.1 Response time ¹⁾

From air to nitrogen at reference operating conditions:

- t_{90} : < 20 s
- t_{98} : < 20 s

9.2.2 Reference operating conditions

Reference temperature: 25 °C (77 °F)

Reference pressure: 1013 hPa (15 psi)

1) Average of all sensors that have undergone a final inspection

9.2.3 Maximum measured error²⁾

±1 % or ±8 µg/l (ppb) of the measured value (the higher value is relevant in each case)³⁾

9.3 Environment

9.3.1 Ambient temperature range

-5 to +60 °C (23 to 140 °F)

9.3.2 Storage temperature range

-25 to 50 °C (-13 to 122 °F)

at 95% relative humidity, non-condensing

9.3.3 Degree of protection

IP68

IP69

9.4 Process

9.4.1 Process temperature range

-5 to +60 °C (23 to 140 °F)

9.4.2 Chemical resistance

NOTICE

Halogen-containing solvents, ketones and toluene

Halogen-containing solvents (dichloromethane, chloroform), ketones (e.g. acetone, pentanone) and toluene have a cross-sensitive effect and result in decreased measured values or, at worst, in the complete failure of the sensor!

► Use the sensor only in media that are free from halogens, ketones and toluene.

9.5 Mechanical construction

9.5.1 Weight

0.1 kg (0.20 lbs)

9.5.2 Materials

Parts in contact with medium

Sensor shaft

Stainless steel 1.4435 (AISI 316L)

Seals/O-rings

EPDM

2) In accordance with IEC 60746-1 at rated operating conditions

3) In accordance with IEC 60746-1 at rated operating conditions

Spot cap

Stainless steel 1.4435 (AISI 316L)

Spot layer

Silicone

9.5.3 Temperature sensor

Pt1000 (Class A according to DIN IEC 60751)



71558605

www.addresses.endress.com
