

Operating Instructions Memosens CPLxxE

pH laboratory sensors with Memosens 2.0
technology







Table of contents







1	About this document	4
1.1	Warnings	4
1.2	Symbols used	4
1.3	Documentation	5
2	Basic safety instructions	6
2.1	Requirements for the personnel	6
2.2	Intended use	6
2.3	Workplace safety	6
2.4	Operational safety	6
2.5	Product safety	7
3	Incoming acceptance and product identification	8
3.1	Incoming acceptance	8
3.2	Product identification	8
3.3	Storage and transport	9
3.4	Scope of delivery	9
4	Electrical connection	10
4.1	Connecting the sensor	10
5	Commissioning	12
5.1	Preliminaries	12
6	Operation	14
6.1	Place of application	14
7	Maintenance	15
7.1	Maintenance tasks	15
8	Repair	16
8.1	General notes	16
8.2	Return	16
8.3	Disposal	16
9	Accessories	16
9.1	Device-specific accessories	16
10	Technical data	17
10.1	Input	17
10.2	Environment	18
Index	19	

1 About this document



1.1 Warnings

Structure of information	Meaning
 <p>Causes (/consequences) If necessary, Consequences of non-compliance (if applicable) ▶ Corrective action</p>	<p>This symbol alerts you to a dangerous situation. Failure to avoid the dangerous situation will result in a fatal or serious injury.</p>
 <p>Causes (/consequences) If necessary, Consequences of non-compliance (if applicable) ▶ Corrective action</p>	<p>This symbol alerts you to a dangerous situation. Failure to avoid the dangerous situation can result in a fatal or serious injury.</p>
 <p>Causes (/consequences) If necessary, Consequences of non-compliance (if applicable) ▶ Corrective action</p>	<p>This symbol alerts you to a dangerous situation. Failure to avoid this situation can result in minor or more serious injuries.</p>
 <p>Cause/situation If necessary, Consequences of non-compliance (if applicable) ▶ Action/note</p>	<p>This symbol alerts you to situations which may result in damage to property.</p>

1.2 Symbols used

	Additional information, tips
	Permitted or recommended
	Not permitted or not recommended
	Reference to device documentation
	Reference to page
	Reference to graphic
	Result of a step

1.2.1 Symbols on the device

	Reference to device documentation
	Do not dispose of products bearing this marking as unsorted municipal waste. Instead, return them to the manufacturer for disposal under the applicable conditions.

1.3 Documentation

The following manuals which complement these Operating Instructions can be found on the product pages on the Internet:

- Technical Information for the relevant sensor
- Operating Instructions for the laboratory devices Liquiline Mobile CML18 and Memobase Plus

2 Basic safety instructions

2.1 Requirements for the personnel

- Installation, commissioning, operation and maintenance of the measuring system may be carried out only by specially trained technical personnel.
- The technical personnel must be authorized by the plant operator to carry out the specified activities.
- The electrical connection may be performed only by an electrical technician.
- The technical personnel must have read and understood these Operating Instructions and must follow the instructions contained therein.
- Faults at the measuring point may only be rectified by authorized and specially trained personnel.

 Repairs not described in the Operating Instructions provided must be carried out only directly at the manufacturer's site or by the service organization.

2.2 Intended use

The CPLxxE pH sensors are designed for short-term measurement in laboratory or field environments.

The pH sensors are not intended for continuous measurements and for fixed installation in the process or in assemblies.

Use of the device for any purpose other than that described, poses a threat to the safety of people and of the entire measuring system and is therefore not permitted.

The manufacturer is not liable for damage caused by improper or non-designated use.

2.3 Workplace safety

As the user, you are responsible for complying with the following safety conditions:

- Installation guidelines
- Local standards and regulations

2.4 Operational safety

Before commissioning the entire measuring point:

1. Verify that all connections are correct.
2. Ensure that electrical cables and hose connections are undamaged.
3. Do not operate damaged products, and protect them against unintentional operation.
4. Label damaged products as defective.

During operation:

- ▶ If faults cannot be rectified:
products must be taken out of service and protected against unintentional operation.

2.5 **Product safety**

The product is designed to meet state-of-the-art safety requirements, has been tested, and left the factory in a condition in which it is safe to operate. The relevant regulations and international standards have been observed.

3 Incoming acceptance and product identification

3.1 Incoming acceptance

1. Verify that the packaging is undamaged.
 - ↳ Notify the supplier of any damage to the packaging.
Keep the damaged packaging until the issue has been resolved.
2. Verify that the contents are undamaged.
 - ↳ Notify the supplier of any damage to the delivery contents.
Keep the damaged goods until the issue has been resolved.
3. Check that the delivery is complete and nothing is missing.
 - ↳ Compare the shipping documents with your order.
4. Pack the product for storage and transportation in such a way that it is protected against impact and moisture.
 - ↳ The original packaging offers the best protection.
Make sure to comply with the permitted ambient conditions.

If you have any questions, please contact your supplier or your local Sales Center.

3.2 Product identification

3.2.1 Nameplate

The nameplate provides you with the following information on your device:

- Manufacturer identification
- Extended order code
- Serial number
- Order identification

► Compare the information on the nameplate with the order.

3.2.2 Product identification

Product page

www.endress.com/cpl51e

www.endress.com/cpl53e

www.endress.com/cpl57e

www.endress.com/cpl59e

Interpreting the order code

The order code and serial number of your product can be found in the following locations:

- On the nameplate
- In the delivery papers

Obtaining information on the product

1. Go to www.endress.com.
2. Page search (magnifying glass symbol): Enter valid serial number.
3. Search (magnifying glass).
 - ↳ The product structure is displayed in a popup window.
4. Click the product overview.
 - ↳ A new window opens. Here you fill information pertaining to your device, including the product documentation.

3.2.3 Manufacturer address

Endress+Hauser Conducta GmbH+Co. KG
Dieselstraße 24
D-70839 Gerlingen

3.3 Storage and transport

All sensors are individually tested and supplied in individual packs. The sensors are equipped with a moistening cap with a bayonet lock. The cap contains a special liquid that prevents the sensor from drying out.

- ▶ If a moistening cap is not used to store the sensor, store the sensor in a KCl solution (3 mol/l) or buffer solution.



Do not allow the sensor to dry out, as this can result in permanent measurement errors.

Sensors must be stored in dry rooms at temperatures of 0 to 50 °C (32 to 122 °F).

NOTICE

Freezing of internal buffer and inner electrolyte!

The sensors can crack at temperatures lower than -15 °C (5 °F).

- ▶ If transporting the sensors, make sure to package them so they are appropriately protected against frost.

3.4 Scope of delivery

The scope of delivery comprises:

- Sensor (version as ordered)
- Operating Instructions

4 Electrical connection

4.1 Connecting the sensor

4.1.1 Connection to handheld device

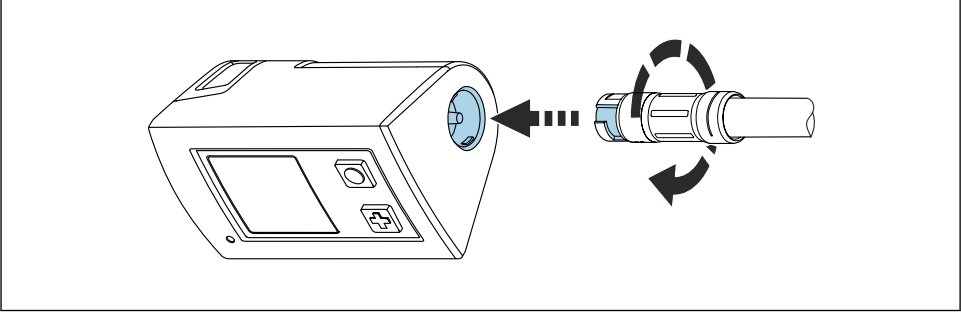

A0041682

1 Sensor connection

1. Insert the sensor into the Memosens connection.
2. Turn the plug-in head of the sensor until it locks into place.

4.1.2 Connection to handheld device via M12 cable

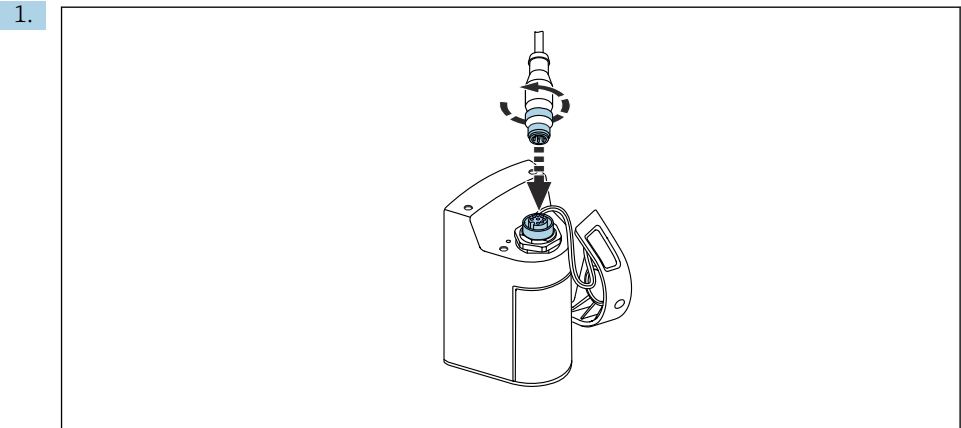

A0041681

Connect the M12 cable to the handheld device.

2.

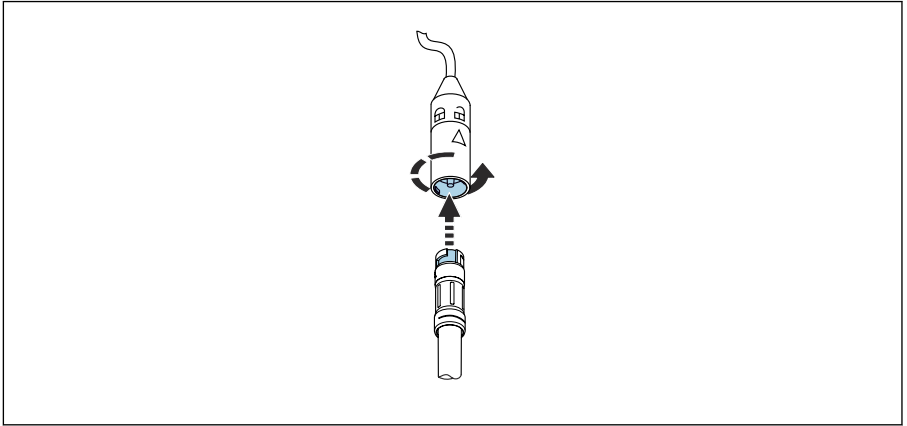

A0041680

Insert the sensor into the Memosens connection of the M12 cable and lock into place.

5 Commissioning

5.1 Preliminaries

Before commissioning the sensor, remove the wetting cap with bayonet connector:

1.

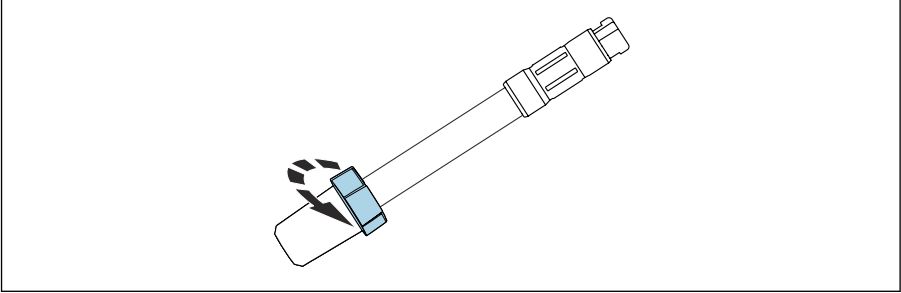

A0041683

Push the connector upwards.

2.

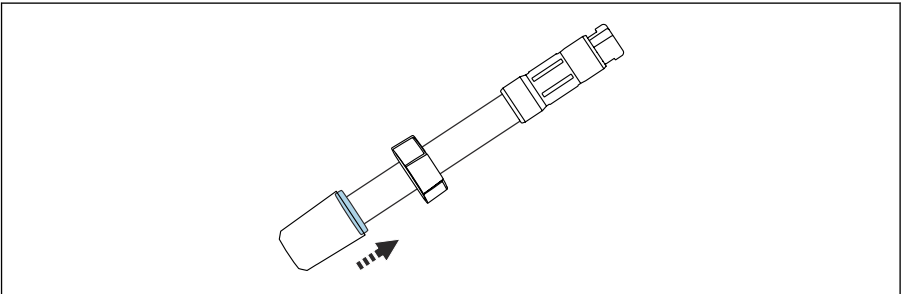

A0047391

The rubber seal, which is located under the lock, must now be pushed up slightly so that an airspace is formed.

↳ The wetting cap can be released easily and without any counterpressure.

3.

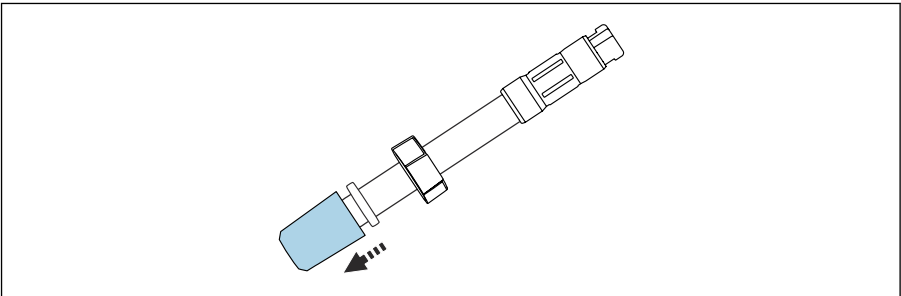

A0047206

Carefully remove the wetting cap from the sensor.

4. Remove the rubber seal and the connector from the sensor.

5.1.1 Calibration and adjustment

- ▶ Refer to the Operating Instructions of the CML18 for the measurement, calibration and adjustment of the sensor on the Liquiline Mobile CML18.



Detailed information on measurement, calibration and adjustment: BA02002C

6 Operation

6.1 Place of application

NOTICE

High ambient temperatures

Possible damage to the Memosens connection!

- ▶ Do not expose the Memosens connection to temperatures above 50 °C (122 °F).
- Do not use the sensor upside-down.
- The angle of application from the horizontal must be at least 15°.

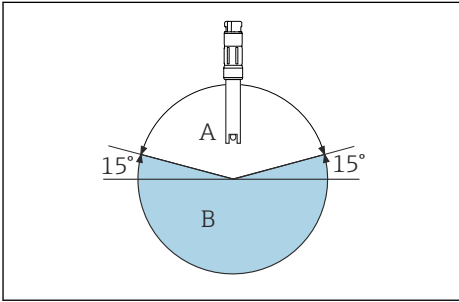

A0041669

2 Angle of application at least 15° from horizontal, plastic sensor

- A Permitted angle of application
- B Impermissible angle of application

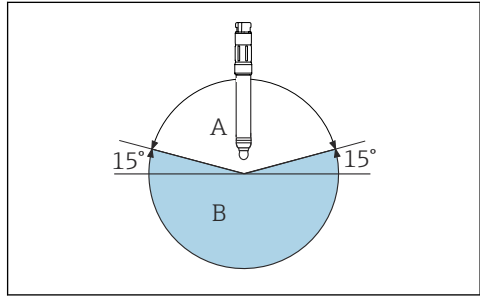

A0028039

3 Angle of application at least 15° from horizontal, glass sensor

- A Permitted angle of application
- B Impermissible angle of application

Put the sensor into operation only if you can answer "yes" to the following questions:

- Are the sensor and cable undamaged?
- Is the angle of application correct?

7 Maintenance

7.1 Maintenance tasks

7.1.1 Cleaning the sensor

- ▶ First rinse the sensor with clear water.

WARNING

Mineral acids and hydrofluoric acid

Risk of serious or fatal injury from caustic burns!

- ▶ Wear goggles to protect eyes.
- ▶ Wear protective gloves and appropriate protective clothing.
- ▶ Avoid all contact with the eyes, mouth and skin.
- ▶ If using hydrofluoric acid, use plastic vessels only.

WARNING

Thiocarbamide

Harmful if swallowed! Limited evidence of carcinogenicity! Possible risk of harm to the unborn child! Dangerous for the environment with long-term effects!

- ▶ Wear protective goggles, protective gloves and appropriate protective clothing.
- ▶ Avoid all contact with the eyes, mouth and skin.
- ▶ Avoid discharge into the environment.

Clean away fouling on the sensor as follows depending on the type of fouling:

1. Oily and greasy films:
Clean with fat solvent, e.g. alcohol, or hot water and agents containing surfactants (alkaline) (e.g. dishwashing detergent).
2. Lime and metal hydroxide buildup and low solubility (lyophobic) organic buildup:
Dissolve buildup with diluted hydrochloric acid (3 %) and then rinse thoroughly with plenty of clear water.
3. Sulfidic buildup (from flue gas desulfurization or wastewater treatment plants):
Use a mixture of hydrochloric acid (3 %) and thiocarbamide (commercially available) and then rinse thoroughly with plenty of clear water.
4. Buildup containing proteins (e.g. food industry):
Use a mixture of hydrochloric acid (0.5 %) and pepsin (commercially available) and then rinse thoroughly with plenty of clear water.
5. Readily soluble biological buildup:
Rinse with pressurized water.

After cleaning, rinse the sensor thoroughly with water and then recalibrate.

8 Repair

8.1 General notes

The repair and conversion concept provides for the following:

- The product has a modular design
- Only use original spare parts from the manufacturer
- Repairs are carried out by the manufacturer's Service Department or by trained users
- Observe applicable standards, national regulations and certificates

8.2 Return

The product must be returned if repairs or a factory calibration are required, or if the wrong product was ordered or delivered. As an ISO-certified company and also due to legal regulations, Endress+Hauser is obliged to follow certain procedures when handling any returned products that have been in contact with medium.

To ensure the swift, safe and professional return of the device:

- ▶ Refer to the website www.endress.com/support/return-material for information on the procedure and conditions for returning devices.

8.3 Disposal



If required by the Directive 2012/19/EU on waste electrical and electronic equipment (WEEE), the product is marked with the depicted symbol in order to minimize the disposal of WEEE as unsorted municipal waste. Do not dispose of products bearing this marking as unsorted municipal waste. Instead, return them to Endress+Hauser for disposal under the applicable conditions.

9 Accessories

The following are the most important accessories available at the time this documentation was issued.

- ▶ For accessories not listed here, please contact your Service or Sales Center.

9.1 Device-specific accessories

Memosens data cable CYK10

- For digital sensors with Memosens technology
- Product Configurator on the product page: www.endress.com/cyk10



Technical Information TI00118C

Memosens laboratory cable CYK20

- For digital sensors with Memosens technology
- Product Configurator on the product page: www.endress.com/cyk20

Liquiline Mobile CML18

- Multiparameter mobile device for laboratory and field
- Reliable transmitter with display and app connection
- Product Configurator on the product page: www.endress.com/CML18



Operating Instructions BA02002C

Memobase Plus CYZ71D

- PC software to support laboratory calibration
- Visualization and documentation of sensor management
- Sensor calibrations stored in database
- Product Configurator on the product page: www.endress.com/cyz71d



Technical Information TI00502C

High-quality buffer solutions from Endress+Hauser - CPY20

The secondary buffer solutions have been referenced to primary reference material of the PTB (German Federal Physico-technical Institute) or to standard reference material of NIST (National Institute of Standards and Technology) according to DIN 19266 by a laboratory accredited by the DAkkS (German accreditation body) according to DIN 17025. Product Configurator on the product page: www.endress.com/cpy20

10 Technical data



For detailed information on technical data, see the "Technical Information" for the relevant sensor.

10.1 Input

10.1.1 Measured variable

pH value

Temperature

10.1.2 Measuring range

CPL51E:

- pH value: 0 to 14 pH
- Temperature: 0 to 80 °C (32 to 176 °F)

CPL53E, CPL57E:

- pH value: 0 to 14 pH (1 to 12 pH application range)
- Temperature: -5 to 100 °C (23 to 212 °F) (0 to 80 °C (32 to 176 °F) application range)

CPL59E:

- pH value: 0 to 14 pH
- Temperature: 0 to 135 °C (32 to 275 °F) (0 to 100 °C (32 to 212 °F) application range)

10.2 Environment

10.2.1 Ambient temperature range

CPL51E, CPL59E**NOTICE****Risk of damage from frost!**

- ▶ Do not use the sensor at temperatures below 0 °C (32 °F).

CPL53E, CPL57E**NOTICE****Risk of damage from frost!**

- ▶ Do not use the sensor at temperatures below -15 °C (5 °F).

10.2.2 Storage temperature

0 to 50 °C (32 to 122 °F), non-freezing

Index

C

- Cleaning the sensor 15
- Commissioning 12

D

- Disposal 16

E

- Electrical connection 10

I

- Incoming acceptance 8

M

- Maintenance 15

O

- Operation 14

P

- Product identification 8

R

- Repair 16
- Return 16

S

- Scope of delivery 9
- Storage 9

T

- Transport 9



71556055

www.addresses.endress.com
