

# Technical Information

## OXY5500

### Optical Oxygen Analyzer



Compact, stand-alone, one-channel analyzer with an LCD display and built-in data logger. The sensor probe uses an optical fiber cable for a reliable signal to the analyzer. Certified for CSA Class I Division 2 and ATEX/IECEX Zone 2.

#### Applications

- Use to monitor O<sub>2</sub> to prevent pipeline corrosion
- Suitable for use in natural gas pipelines, gas processing plants, and vapor recovery units
- Ranges from 0 to 10 ppmv to 0 to 20% O<sub>2</sub>

#### Key Features

- Easy-to-navigate display and menu
- Low power consumption
- Data logging for 30 days
- Small optical sensor; no membrane or consumable chemicals
- Excellent long term stability
- Not affected by H<sub>2</sub>S or other sulfur species
- Fast and continuous
- CSA and ATEX/IECEX Certification

## Table of Contents

<b>1 Introduction.....</b>	<b>3</b>
Product overview.....	3
Standard documentation.....	4
Registered trademarks .....	4
Manufacturer address .....	4
<b>2 System design.....</b>	<b>5</b>
Measuring system.....	5
Equipment architecture.....	7
<b>3 Certificates and approvals.....</b>	<b>9</b>

CE mark .....	9
Ex approval.....	9
RCM mark.....	9
FCC mark .....	9
Area classifications .....	9
<b>4 Ordering Information .....</b>	<b>10</b>
Product Configurator.....	10
Order codes.....	10
Gas specifications .....	13
Technical data .....	14

# 1 Introduction

## Product overview

The Endress+Hauser **OXY5500 Optical Oxygen Analyzer** is a compact, stand-alone, one-channel analyzer with an LCD display and built-in data logger. The sensor probe is inserted into the process stream and is connected to the controller by an optical fiber.

Full Sample Conditioning Systems (SCS) are available with the OXY5500 as well as software for PC interface.

**Low maintenance:** The analyzer uses an optical method that detects oxygen using a probe that is inserted into the gas stream. The probe can be easily cleaned and has a lifetime measured in years.

Calibration of the analyzer is a simple procedure that can be performed in minutes using a binary standard with oxygen in nitrogen.

**Accurate and reliable:** OXY5500 technology is ideally suited for measuring in Natural Gas and Gas Processing applications.

The sensor is not affected by even high levels of H<sub>2</sub>S or other sulfur species. There is no cross sensitivity to contaminants or other gases in natural gas.

The electronics are certified for hazardous area use. The accuracy and reliability of the measurements are superior to the electrochemical analyzers.

### The Quench Fluorescence Method:

1. Blue LED light is transmitted to the sensor tip causing it to emit "fluorescence."

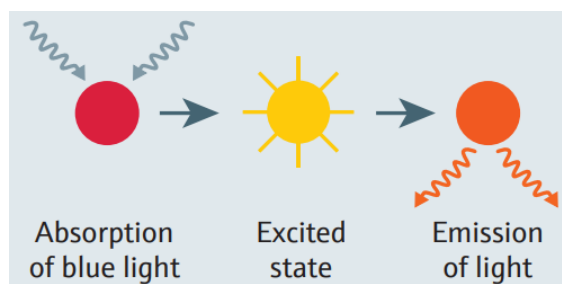

2. When the sensor tip comes into contact with oxygen, the O<sub>2</sub> molecules absorb energy, preventing the emission.

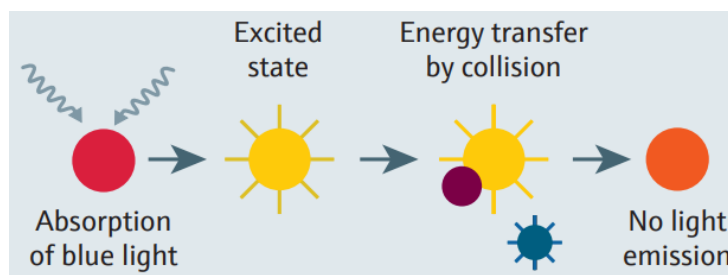

The amount of oxygen is inversely proportional to the intensity and duration of the luminescence.

**Standard  
documentation**

Each analyzer shipped from the factory is packaged with documents specific to the model that was purchased. All documentation is available on the Endress+Hauser website at [www.endress.com](http://www.endress.com) and on the USB drive included in the shipping package.

This Technical Information document is an integral part of the complete document package, which also includes:

<b>Part Number</b>	<b>Document Type</b>	<b>Description</b>
BA02195C	Operating Instruction	Provides the most common options and accessories
BA02196C	SCS Operating Instruction	Provides an overview of the SCS and its components, operation and troubleshooting
XA02754C	Safety Instruction	Provides the most common safety issues related to the installation and operation of the analyzer
SD02868C	Service Software Operating Instruction	Provides instruction for operating, diagnosing and servicing the analyzer

**Registered trademarks****Modbus®**

Registered trademark of SCHNEIDER AUTOMATION, INC.

**Manufacturer address**

Endress+Hauser  
11027 Arrow Route  
Rancho Cucamonga, CA 91730  
United States  
[www.endress.com](http://www.endress.com)

## 2 System design

### Measuring system

#### OXY5500 Optical Oxygen Analyzer

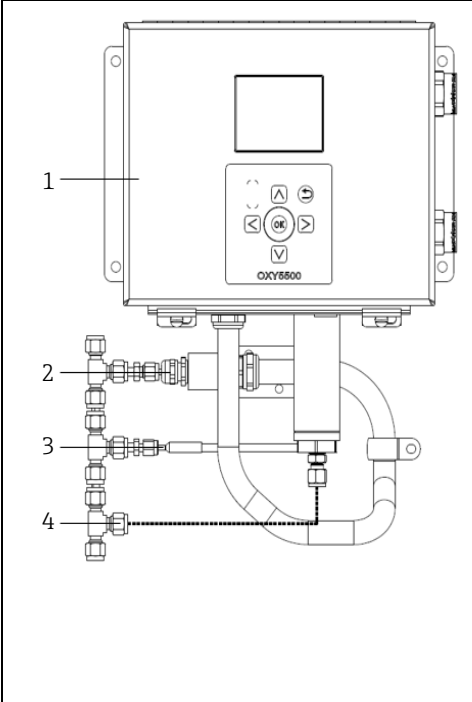
	<p>The base analyzer consists of:</p> <ol style="list-style-type: none"> <li>1. Controller Contains the power supply, HMI (LCD display and keypad), communications and measurement control electronics.</li> <li>2. Oxygen probe Blue LED light is transmitted to the sensor tip. The presence of oxygen prevents the sensor tip from emitting fluorescent light.</li> <li>3. RTD probe RTD probe measures the temperature of the process stream.</li> <li>4. Pressure port (optional) Pressure transducer reads the pressure in the system.</li> </ol>
---	---

#### OXY5500 Optical Oxygen Analyzer with SCS on panel

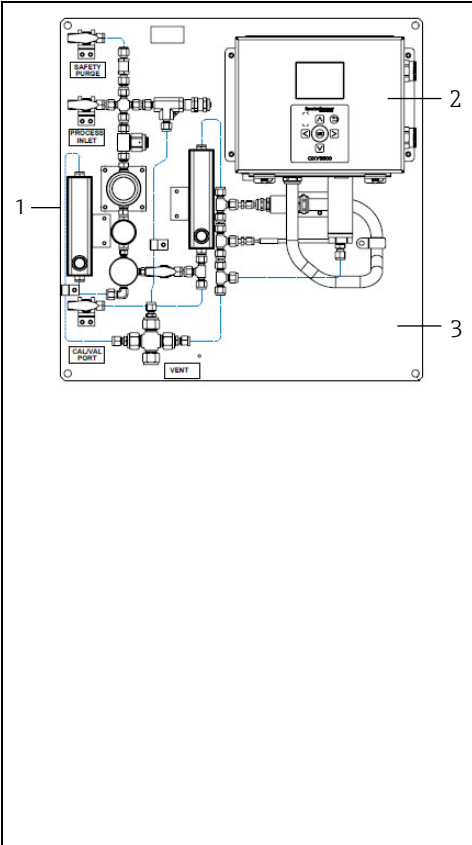
	<p>The analyzer system on a panel consists of the following and is designed for exterior mounting near the sample extraction point or inside a shelter.</p> <ol style="list-style-type: none"> <li>1. Sample conditioning components Components used to filter the gas while maintaining a representative sample and control the pressure and flow. An optional bypass is available as a speed loop and to continually sweep the dirty side of the membrane separator.</li> <li>2. OXY5500 Optical Oxygen Analyzer See description above.</li> <li>3. Anodized aluminum panel (Other materials can be special ordered.) Allows easy mounting to a wall, Unistrut frame, or post and provides a mounting surface of the sample conditioning components.</li> </ol>
--	---

**OXY5500 Optical Oxygen Analyzer with enclosed SCS, with heater**

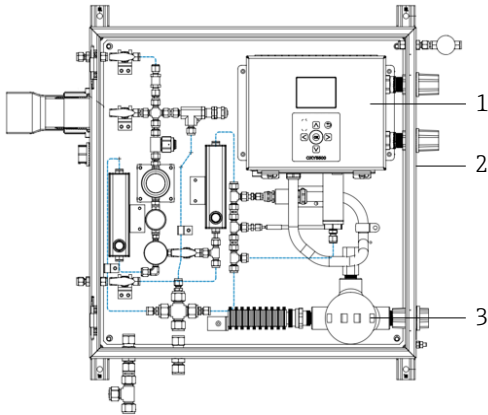
	<p>The enclosed analyzer system with optional heater consists of the following and is typically used for exterior mounting near the sample extraction point.</p> <ol style="list-style-type: none"> <li>1. OXY5500 Optical Oxygen Analyzer See description above.</li> <li>2. Stainless steel enclosure Allows easy mounting to a wall, Unistrut frame, or post and provides a protected environment for the SCS and analyzer.</li> <li>3. Heater system (optional) Includes a heater with thermostat for condensation protection and stable temperatures in colder weather. When a heater is employed, the enclosure will be outfitted with insulation to reduce heat loss and with a heat trace boot for the gas inlet.</li> </ol>
---	--

**OXY5500 Optical Oxygen Analyzer with SCS in transportable case**

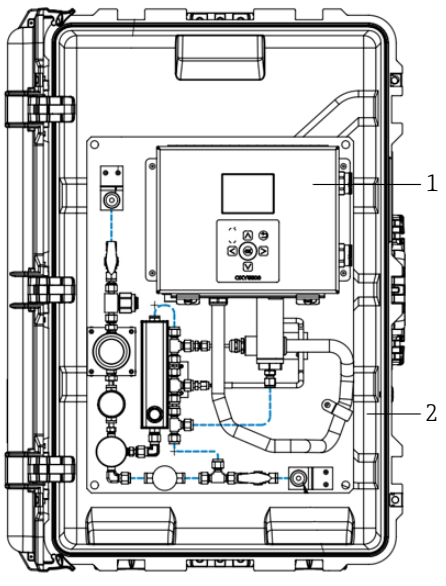
	<p>The enclosed analyzer system with optional heater consists of the following and is typically used for exterior mounting near the sample extraction point.</p> <ol style="list-style-type: none"> <li>1. OXY5500 Optical Oxygen Analyzer See description above.</li> <li>2. Transportable case Allows for easy transportation of analyzer in durable carrying case.</li> </ol>
---	--

Equipment architecture

OXY5500 Optical Oxygen Analyzer – panel mount

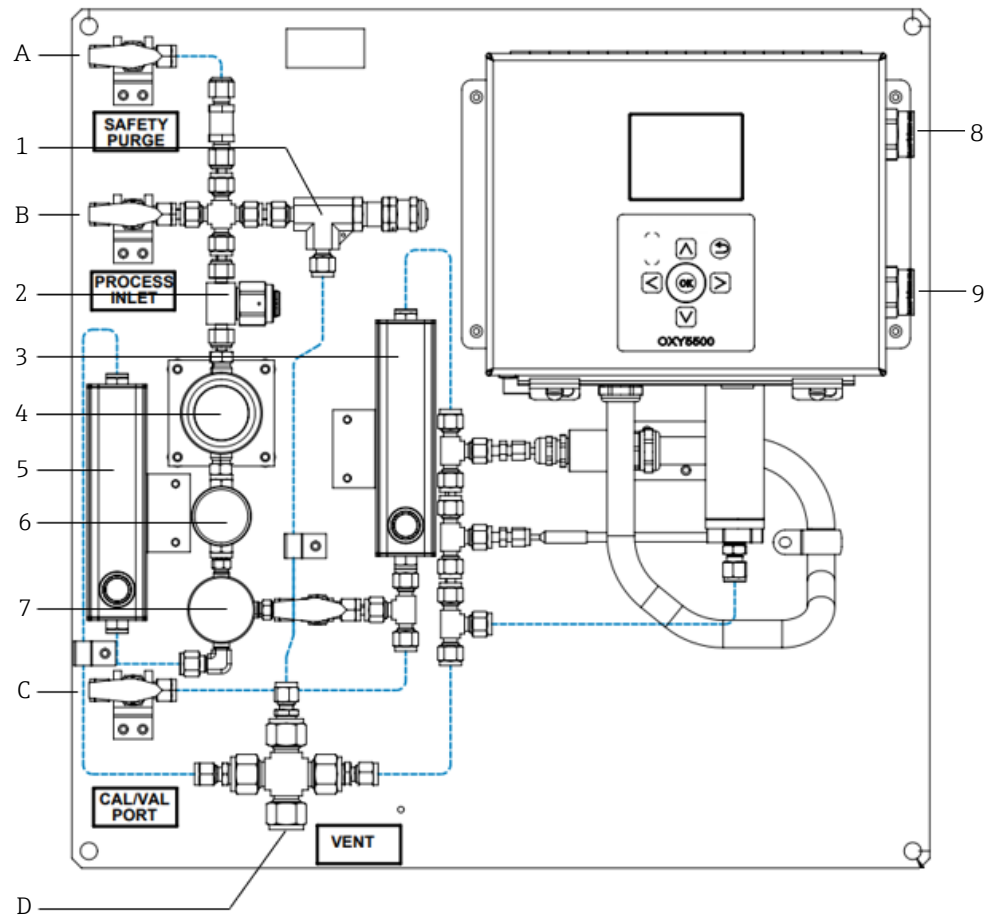

- |   |   |
|---|---|
| <ul style="list-style-type: none"> <li>1 Pressure relief valve</li> <li>2 Filter</li> <li>3 Analyzer flow indicator and control</li> <li>4 Pressure regulator</li> <li>5 Bypass flow indicator and control</li> <li>6 Pressure gauge</li> <li>7 Membrane separator</li> <li>8 Signal wiring</li> <li>9 Analyzer power connection</li> </ul> | <ul style="list-style-type: none"> <li>A Sample purge in, 140 to 275 kPa (20 to 40 psi)</li> <li>B Sample in, 140 to 275 kPa (20 to 40 psi)</li> <li>C Reference gas in, 15 to 70 kPa (2 to 10 psi)</li> <li>D Sample vent to safe area, 90 to 120 kPa (800-120 mbara)</li> </ul> |
|---|---|

### OXY5500 Optical Oxygen Analyzer – heated enclosure

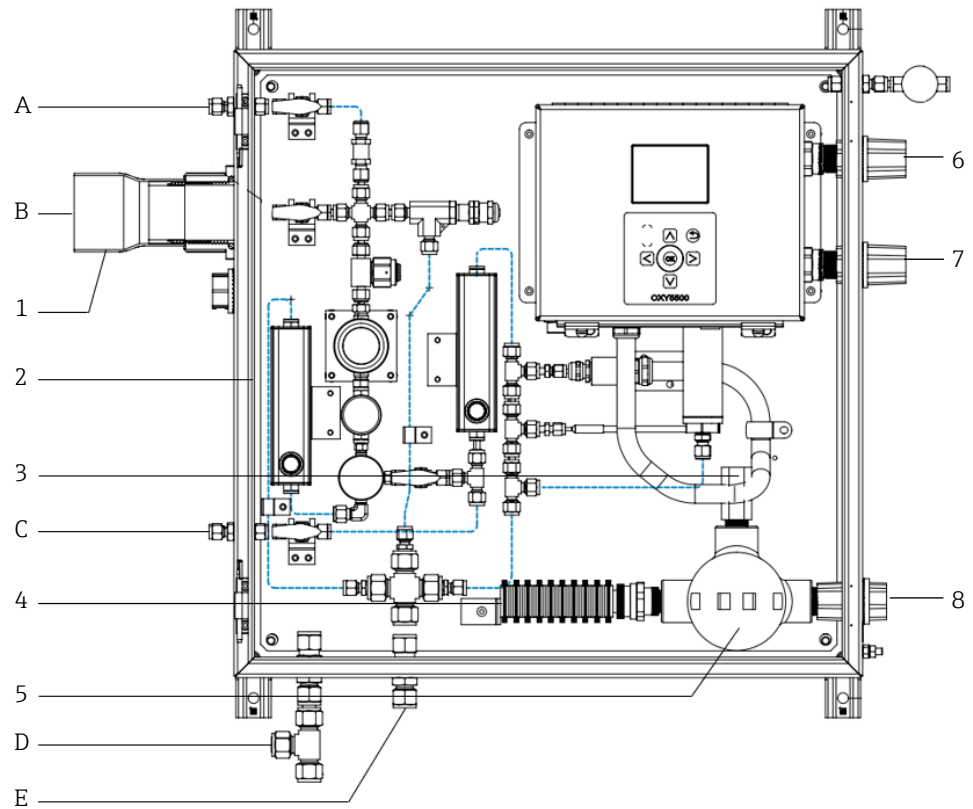

- |   |                           |   |  |
|---|---------------------------|---|--|
| 1 | Heat trace boot           | A | Sample purge in, 140 to 275 kPa (20 to 40 psi)           |
| 2 | Insulation                | B | Sample in, 140 to 275 kPa (20 to 40 psi)                 |
| 3 | Thermostat                | C | Reference gas in, 15 to 70 kPa (2 to 10 psi)             |
| 4 | Heater                    | D | Enclosure vent to safe area, atm                         |
| 5 | Heater power terminal     | E | Sample vent to safe area, 80 to 120 kPa (800-1200 mbara) |
| 6 | Signal wiring             |   |  |
| 7 | Analyzer power connection |   |  |
| 8 | Heater power connection   |   |  |



### 3 Certificates and approvals

#### CE mark

The OXY5500 Optical Oxygen Analyzer meets the legal requirements of the applicable EU Directives. These are listed in the corresponding EU Declaration of Conformity along with the standards applied.

Endress+Hauser confirms successful testing of the device by affixing to it the CE mark.

#### Ex approval

The measuring device is certified for use in hazardous areas and the relevant safety instructions are provided in the separate “Safety Instructions” document. Reference is made to this document on the nameplate.

The Safety Instructions containing all the relevant explosion protection data is available from the Endress+Hauser website.

#### RCM mark

The OXY5500 Optical Oxygen Analyzer has been registered in the Electrical Equipment Safety System (EESS) database used by the Australian Communication and Media Authority (ACMA), the Electrical Regulatory Authorities Council (ERAC) and Radio Spectrum Management (New Zealand).

#### FCC mark

The OXY5500 Optical Oxygen Analyzer is below the stated electromagnetic radiation limits specified by the Federal Communications Commission. Endress+Hauser has followed the requirements of the Supplier’s Declaration of Conformity authorization procedures.

#### Area classifications

Model	Certifications
OXY5500 Optical Oxygen Analyzer	<p><u>cCSAus:</u> Class I, Division 2, Groups A, B, C, D, T4, Type 4X and IP64 Tambient: -20 °C to +60 °C</p> <p><u>ATEX/IECEX:</u> Ex II 3G</p> <p> Ex nA IIC T3 Gc IP64 Tambient: -20 °C to +60 °C</p>

## 4 Ordering Information

### Product Configurator

Detailed ordering information is available for your nearest sales organization at [www.addresses.endress.com](http://www.addresses.endress.com) or in the Product Configurator under [www.endress.com](http://www.endress.com). To access:

1. Click **Corporate**.
2. Select the country.
3. Click **Products**.
4. Click **Product finder**.
5. Select the product using the filters and search field.
6. Open the product page.
7. Click the **Configure** button to open the Product Configurator.

**Product Configurator** is a tool for individual product configuration that offers:

- Up-to-the-minute configuration data
- Automatic verification of exclusion criteria
- Automatic creation of the order code and its breakdown in PDF or Excel output format
- Ability to order directly in the Endress+Hauser Online Shop

If a certain product is not available in your region, refer to the website ([www.endress.com/contact](http://www.endress.com/contact)) to locate your local sales channel for more information.

### Order codes

Feature Number	Order Code	Description
<b>Measurement Range (Choose one)</b>		
010	1	0-1000 ppmv O <sub>2</sub> Range <sup>1</sup>
	2	0-5% O <sub>2</sub> Range <sup>1</sup>
	3	0-20% O <sub>2</sub> Range <sup>1</sup>
	Y	TSP – Number to be specified
<b>Background (Choose one)</b>		
020	1	Natural Gas (Stream composition is required if it does not align with Tables 1, 2, or 3)
	2	Pure Air or Nitrogen
	Y	TSP – Number to be specified
<b>Probe Fiber Length (Choose one)</b>		
030	0	0.7 meters (order this length for use with Sample Systems)
	1	2.5 meters with Conduit
	2	5.0 meters with Conduit

<b>Pressure Compensation (Choose one)</b>		
040	0	None – Analyzer calibrated in-situ
	1	Pressure sensor included – Factory calibrated for 800-1400 mbar
<b>Input Power (Choose one)</b>		
050	1	108-253 VAC
	2	9-30 VDC; 18-30 VDC (IEC/ATEX)
<b>Cable Entries (Choose one)</b>		
060	1	Thread 3/4 NPT
	2	Thread M20
<b>Enclosure Material (Choose one)</b>		
070	1	304 Stainless Steel
	2	316 Stainless Steel
<b>Analyzer Mounting (Choose one)</b>		
080	0	None – Analyzer only; no SCS
	1	Analyzer Mounted on Aluminum Panel
	2	Analyzer System Mounted Inside Overall 304SS Enclosure
	3	Analyzer System Mounted Inside Overall 316SS Enclosure
	4	Remote Sample System Panel Mount <sup>2</sup>
	Y	TSP – Number to be specified
<b>Sample Conditioning System (Choose one)</b>		
090	0	None
	1	Single Stream with Regulator, Bypass, Flowmeters, Filtration (1/4 inch) <sup>4</sup>
	2	Single Stream with Regulator, Bypass, Flowmeters, Filtration (6 mm) <sup>4</sup>
	3	Same as 1 with Khrono Armored Flowmeter and Parker Veriflo Regulator <sup>5</sup>
	4	Same as 2 with Khrono Armored Flowmeter and Parker Veriflo Regulator <sup>5</sup>
	5	Single Stream with Regulator, Bypass, Flowmeters, Filter – Transportable <sup>3, 8</sup>
	Y	TSP – Number to be specified

<b>Enclosure Heater (Choose one)</b>		
100	0	None
	1	120VAC Heated Enclosure + Temperature Control and Insulation (CSA) <sup>6</sup>
	2	120VAC Heated Enclosure + Temperature Control and Insulation (IECEX) <sup>6</sup>
	Y	TSP – Number to be specified
<b>Safety Purge Kit (Choose one)</b>		
110	0	None
	1	Purge Kit for Applications with >300 ppmv H <sub>2</sub> S (Panel Mount) <sup>7</sup>
	2	Purge Kit for Applications with >300 ppmv H <sub>2</sub> S (Enclosure Mount) <sup>7</sup>
<b>Marking (Choose one)</b>		
120	0	None
	T1	Stainless Steel Tag (up to 2 lines of text)

**NOTES**







1. Smaller ranges within the stated range are set in the instrument by the user.
2. When choosing this option, be sure to select the appropriate “Probe Fiber Length” above (do not choose options 0 or 3).
3. Includes Quick Connect Fittings. Must order with “Analyzer Mounting” option 1.
4. Includes Neon pressure regulator (Series 10) and King Glass Tube Flow Meter (Model 7430).
5. Includes Parker Veriflo pressure regulator (Model IR4000) and Khrono flow meter (Model DK-32).
6. Heater ordered with “Analyzer Mounting” options 2 and 3 only. 120 VAC comes with 3/4 inch cable entries. 240 VAC comes with M20 cable entries. Heated enclosures include heat trace boot.
7. Includes safety kit for >300 ppmv H<sub>2</sub>S; purge connections, warning labels, and sensor port for enclosure when applicable.
8. Transportable; this option includes a Pelican carrying case.

## Gas specifications

Component name	Abbreviation	Allowable component range		
		Natural gas	Rich natural gas	Rich natural gas/pure CO <sub>2</sub>
		Table 1	Table 2	Table 3
Methane	C <sub>1</sub>	90 to 100%	50 to 100%	0 to 50%
Ethane	C <sub>2</sub>	0 to 7%	0 to 20%	0 to 20%
Propane	C <sub>3</sub>	0 to 2%	0 to 15%	0 to 15%
Butanes	C <sub>4</sub>	0 to 1%	0 to 5%	0 to 5%
Pentanes	C <sub>5</sub>	0 to 0.2%	0 to 2%	0 to 2%
Hexanes and heavier	C <sub>6+</sub>	0 to 0.2%	0 to 2%	0 to 2%
Carbon dioxide	CO <sub>2</sub>	0 to 3%	0 to 20%	50 to 100%
Nitrogen and other inerts	N <sub>2</sub>	0 to 10%	0 to 20%	0 to 20%
Hydrogen sulfide	H <sub>2</sub> S	0 to 300 ppmv	0 to 5%	0 to 5%
Water	H <sub>2</sub> O	0 to 5000 ppmv	0 to 5000 ppmv	0 to 5000 ppmv

## Technical data

<b>Measurement data</b>			
Target components	Refer to Application Note (AI01218C)		
Principle of measurement	Quenched Fluorescence (QF)		
Measurement ranges	OP-9	OP-6	OP-3
	0 to 10 to 0 to 1000 ppmv user setting	0 to 1 to 0 to 5% user setting	0 to 10 to 0 to 20% user setting
Lower limit of detection	0.5 ppmv	20 ppmv	300 ppmv
Accuracy at 20 to 25 °C	±2 ppmv or ±5% of reading	±3% of reading	±2% of reading
Repeatability	±1% of reading		
<b>Application data</b>			
Ambient temperature range	-20 °C to 50 °C (-4 °F to 122 °F)		
Maximum probe pressure	275 kPag (40 psig)		
Sample pressure range (sample to system inlet)	Typically between 140 to 275 kPag (20 to 40 psig)		
Sample pressure range (at sensor)	800 to 1200 mbara		
Sample flow rate	1.0 slpm (2.1 scfh)		
Bypass flow rate	1.0 slpm (2.1 scfh)		
<b>Electrical and communication</b>			
Input power	108 to 253 VAC, 50/60 Hz; 5.3W at 120VAC; 6.6W at 240 VAC or 9 to 30 VDC (CSA), 18 to 30 VDC (IEC/ATEX); 4.7W at 24VDC		
Communication	Analog: Qty 2, 4-20mA outputs and Qty 1, 4-20mA input (sample pressure)  Fieldbus: RS-232C, RS-485 and Ethernet 10/100 with Modbus  Output Relays: Qty 2, 250mA max load (concentration and fault alarms)  USB 2.0 works with service software only  4GB internal memory with internal data logging		
LCD display	Concentration, temperature, sample rate, data logging, diagnostics, plus full menu for setup, calibration, etc.		
Service software	Windows software Connect via USB port Download data logs, trend and monitor, calibrate and troubleshoot		

<b>Physical</b>	
Electronics enclosure type	NEMA Type 4X and IP64, 304 or 316L stainless steel
Analyzer dimensions	280 mm H x 230 mm W x 114 mm D (11 x 9 x 4.5 inches) Does not include sample conditioning system
Analyzer with sample system	On panel: 560 mm H x 560 mm W x 115 mm D (22 x 22 x 4.5 inches) Enclosed: 610 mm H x 610 mm W x 233 mm D (24 x 24 x 9.2 inches)
Probe cable length	0.7 m standard (2.5 m and 5.0 m – optional)
Analyzer weight	2.2 kg (4.9 lbs) – analyzer without sample system 14 kg (31 lbs) – analyzer on a panel 35.4 kg (78 lbs) – analyzer in enclosure
Optical probe jacket material	304 series polished stainless steel
Sample conditioning system wetted materials	316 Stainless Steel with electro-polished tubing and components
<b>Certification</b>	
Analyzer	     

TI01656C/66/EN/01.21

[www.addresses.endress.com](http://www.addresses.endress.com)

---