

# Operating Instructions

## FieldEdge SGC500

Industrial Edge Device to connect field devices to the Netilion Cloud



## Revision history

Product version	Operating Instructions	Changes	Comments
0.01.00	BA02035S/04/EN/01.20	–	Initial version
0.02.00	BA02035S/04/EN/02.20	EtherNet/IP New chapters and changes	
0.02.00	BA02035S/04/EN/03.21	Section 9: Changes	

# Table of contents

<b>1</b>	<b>About this document</b> .....	<b>4</b>	9.3	Manually connecting the SGC500 to the Netilion Cloud .....	19
1.1	Document function .....	4	9.4	Connecting to the field network .....	21
1.2	Symbols used .....	4	9.5	Connecting to the field gateway .....	22
1.3	Documentation .....	5	9.6	Connecting to the EtherNet/IP .....	23
1.4	Registered trademarks .....	5			
<b>2</b>	<b>Basic safety instructions</b> .....	<b>6</b>	<b>10</b>	<b>FieldEdge SGC500 and Netilion</b> .....	<b>23</b>
2.1	Requirements for the personnel .....	6	10.1	Using the FieldEdge SGC500 in Netilion .....	23
2.2	Designated use .....	6	10.2	About Netilion .....	24
2.3	Workplace safety .....	6			
2.4	Operational safety .....	6	<b>11</b>	<b>Maintenance</b> .....	<b>24</b>
2.5	Product safety .....	6	<b>12</b>	<b>Diagnostics and troubleshooting</b> .....	<b>25</b>
2.6	IT security .....	7	<b>13</b>	<b>Software updates</b> .....	<b>25</b>
<b>3</b>	<b>Product description</b> .....	<b>7</b>	<b>14</b>	<b>Serial number SGC500</b> .....	<b>25</b>
3.1	Function .....	7	<b>15</b>	<b>Repairs</b> .....	<b>25</b>
3.2	Application .....	7	15.1	General notes .....	25
3.3	Licensing model .....	8	15.2	Return and / or cancellation of Netilion Subscription .....	26
3.4	System design .....	9	15.3	Disposal .....	26
3.5	Communication and data processing .....	9			
3.6	Product design .....	11			
<b>4</b>	<b>Incoming acceptance and product identification</b> .....	<b>12</b>			
4.1	Incoming acceptance .....	12			
4.2	Product identification .....	12			
4.3	Storage and transport .....	13			
<b>5</b>	<b>Installation</b> .....	<b>13</b>			
5.1	Installation conditions .....	13			
5.2	Mounting the device .....	14			
5.3	Post-installation check .....	14			
<b>6</b>	<b>Electrical connection</b> .....	<b>15</b>			
6.1	Connection conditions .....	15			
6.2	Connecting the device .....	15			
6.3	Post-connection check .....	16			
<b>7</b>	<b>Operation options</b> .....	<b>16</b>			
<b>8</b>	<b>System integration</b> .....	<b>16</b>			
<b>9</b>	<b>Commissioning</b> .....	<b>16</b>			
9.1	Connecting the SGC500 .....	16			
9.2	Automatically connecting the SGC500 to the Netilion Cloud .....	19			

# 1 About this document

## 1.1 Document function

These Operating Instructions contain all the information that is required in various phases of the life cycle of the device: from product identification, incoming acceptance and storage, to mounting, connection, operation and commissioning through to troubleshooting, maintenance and disposal.

## 1.2 Symbols used

### 1.2.1 Safety symbols

#### DANGER

This symbol alerts you to a dangerous situation. Failure to avoid this situation will result in serious or fatal injury.

#### WARNING

This symbol alerts you to a dangerous situation. Failure to avoid this situation can result in serious or fatal injury.







#### CAUTION





This symbol alerts you to a dangerous situation. Failure to avoid this situation can result in minor or medium injury.

#### NOTICE



This symbol contains information on procedures and other facts which do not result in personal injury.

### 1.2.2 Symbols for certain types of information

Symbol	Meaning
	<b>Permitted</b> Procedures, processes or actions that are permitted.
	<b>Preferred</b> Procedures, processes or actions that are preferred.
	<b>Forbidden</b> Procedures, processes or actions that are forbidden.
	<b>Tip</b> Indicates additional information.
	Reference to documentation.
	Reference to page.
	Reference to graphic.

Symbol	Meaning
	Notice or individual step to be observed.
	Series of steps.
	Result of a step.
	Help in the event of a problem.
	Visual inspection.

### 1.2.3 Symbols in graphics

Symbol	Meaning	Symbol	Meaning
1, 2, 3,...	Item numbers		Series of steps
A, B, C, ...	Views	A-A, B-B, C-C, ...	Sections
	Hazardous area		Safe area (non-hazardous area)

## 1.3 Documentation

### FieldEdge SGC500

- Operating Instructions BA02035S
- Technical Information TI01525S

## 1.4 Registered trademarks

### HART®

Registered trademark of the FieldComm Group, Austin, USA

### WirelessHART®

Registered trademark of the FieldComm Group, Austin, USA

### PROFIBUS®

Registered trademark of the PROFIBUS User Organization, Karlsruhe, Germany

### EtherNet/IP™

Trademark of ODVA, Inc.

## 2 Basic safety instructions

### 2.1 Requirements for the personnel

The personnel for installation, commissioning, diagnostics and maintenance must fulfill the following requirements:

- ▶ Trained, qualified specialists must have a relevant qualification for this specific function and task.
- ▶ Are authorized by the plant owner/operator.
- ▶ Are familiar with federal/national regulations.
- ▶ Before starting work, read and understand the instructions in the manual and supplementary documentation as well as the certificates (depending on the application).
- ▶ Follow instructions and comply with basic conditions.

The operating personnel must fulfill the following requirements:

- ▶ Are instructed and authorized according to the requirements of the task by the facility's owner-operator.
- ▶ Follow the instructions in this manual.

### 2.2 Designated use

The FieldEdge SGC500 must be installed, connected and configured in accordance with the instructions in this manual.

The FieldEdge SGC500 is not approved for hazardous areas.

### 2.3 Workplace safety

For work on and with the device:

- ▶ Wear the required personal protective equipment according to federal/national regulations.

### 2.4 Operational safety

Risk of injury!

- ▶ Operate the device only if it is in proper technical condition, free from errors and faults.
- ▶ The operator is responsible for interference-free operation of the device.

#### Modifications to the device

Unauthorized modifications to the device are not permitted and can lead to unforeseeable dangers:

- ▶ If modifications are nevertheless required, consult with Endress+Hauser.

### 2.5 Product safety

The SGC500 meets the requirements of the EU Directives as per the CE mark.

## 2.6 IT security

We only provide a warranty if the device is installed and used as described in the Operating Instructions. The device is equipped with security mechanisms to protect it against any inadvertent changes to the device settings.

IT security measures in line with operators' security standards and designed to provide additional protection for the device and device data transfer must be implemented by the operators themselves.

# 3 Product description

## 3.1 Function

The FieldEdge SGC500 enables the connection of field devices in an industrial plant to the Netilion Cloud. Data transmission is via the Internet connection in the plant. The information required for Netilion Services is regularly read out of the field devices and saved to the Netilion Cloud.

Use the transmitted data via the following services:

- Netilion Connect or
- Netilion Services

### Netilion Connect

The transmitted data can be retrieved directly via a software interface (REST JSON Application Programming Interface (API)) and integrated into a user application.



The Application Programming Interface (API) is provided as part of the Netilion Connect Subscription.

### Netilion Services

The transmitted data enable digital Netilion Services, such as Analytics, Health, Library and Value.

## 3.2 Application

The FieldEdge SGC500 consists of hardware and Endress+Hauser software.

The FieldEdge connects the field to the Netilion Cloud. The FieldEdge is installed in a cabinet in an automation system and permanently connected to the field network and, via a second network, to the Internet. The information read in from the field devices is interpreted and transmitted to the Netilion Cloud via the Internet connection.

The Endress+Hauser software offers the following:

- Read-only connection to field devices via a variety of fieldbus protocols and field gateways. Optional field device write accesses are documented in Netilion Services and require user confirmation.
- Data processing and encrypted transmission of data exclusively to the Netilion Cloud.
- Specific data acquisition for the digital services the user has subscribed to in Netilion.
- Automatic updates run in the background: security updates, software modifications and functional enhancements.

 No provisions are made for incoming communication from the Internet and it must be blocked in the system firewall. Routing to the field network is not possible.

### 3.3 Licensing model

A Field Edge SGC500 can only be ordered as an option in conjunction with a Netilion subscription to [www.netilion.endress.com](http://www.netilion.endress.com) or <https://developer.netilion.endress.com/discover>. Subscription fees are charged on an annual basis. After terminating the subscription, the SGC500 must be destroyed safely or returned to Endress+Hauser. In the event of a hardware defect, Endress+Hauser will provide a replacement device if the device is found to have an irreparable defect.



### 3.4 System design

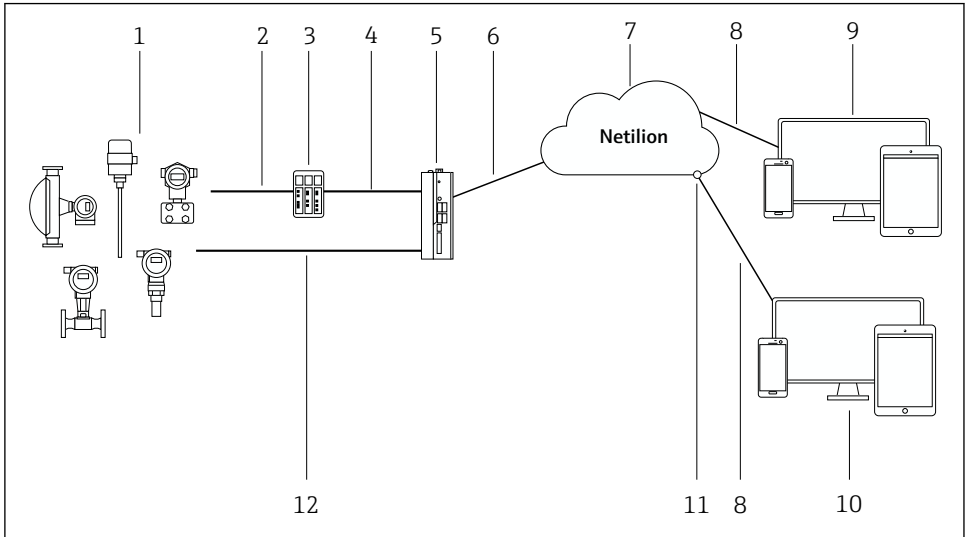

#### 1 Network architecture

- 1 Endress+Hauser field devices and third-party field devices
- 2 Fieldbus communication
- 3 Supported field gateways for conversion from fieldbus protocol to an IP protocol
- 4 Ethernet communication
- 5 FieldEdge SGC500, reads field device data and transmits it securely to the Netilion Cloud
- 6 WAN Internet connection – https, plant-side connection
- 7 Netilion Cloud
- 8 https Internet connection
- 9 Netilion Services: Netilion Service app based on internet browser
- 10 User application
- 11 Netilion Connect: Application Programming Interface (API)
- 12 Industrial Ethernet



- For detailed information on Netilion Connect, see: <https://developer.netilion.endress.com/discover>
- For detailed information on Netilion Services, see: <https://netilion.endress.com>

### 3.5 Communication and data processing

Supported fieldbus communication	Connection to FieldEdge
HART	Fieldbus via field gateway to Ethernet connection
WirelessHART	

<b>Supported fieldbus communication</b>	<b>Connection to FieldEdge</b>
PROFIBUS	
EtherNet/IP	Direct via industrial Ethernet connection

<b>FieldEdge</b>	<b>Connection to the Netilion Cloud</b>
FieldEdge SGC500	Internet connection: WAN – https

### 3.6 Product design

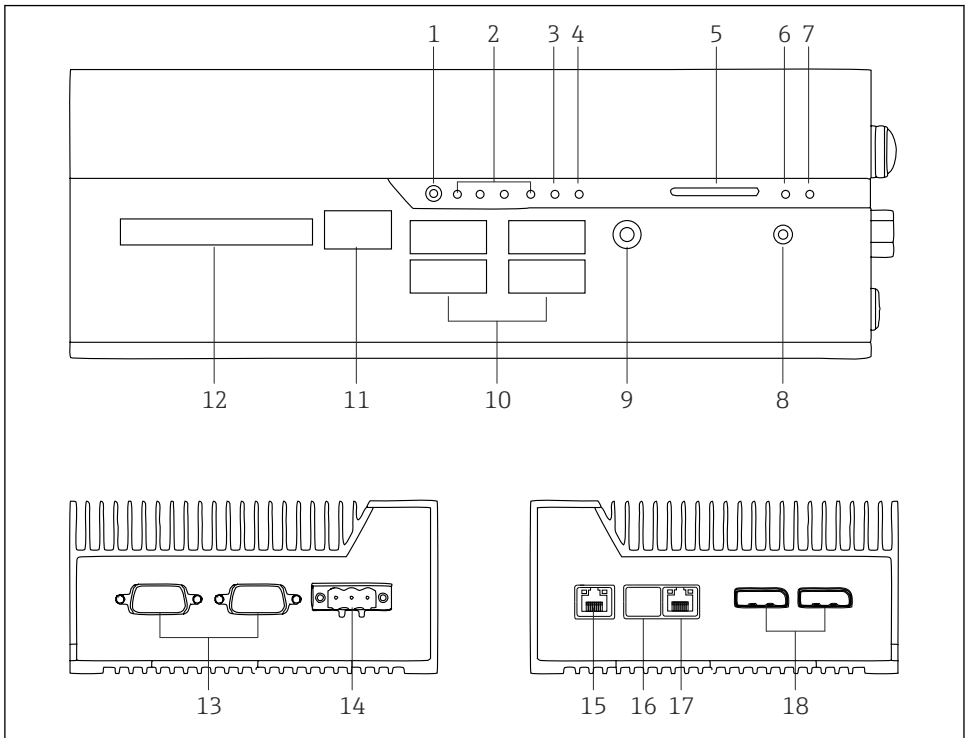

2 FieldEdge SGC500

- 1 User switch mode
- 2 LEDs
- 3 Watchdog
- 4 Motor vehicle ignition (not used)
- 5 SD card slot (not used)
- 6 Power LED
- 7 HDD hard drive LED
- 8 ON switch
- 9 Audio connection (not used)
- 10 USB 3.0 (not used)
- 11 CAN bus (not used)
- 12 DIO (not used)
- 13 RS-232/422/485 COM ports (not used)
- 14 Power supply
- 15 GbE LAN
- 16 GbE LAN (not used)
- 17 GbE LAN
- 18 Display port (not used)

## 4 Incoming acceptance and product identification

### 4.1 Incoming acceptance

- Check the packaging for visible damage arising from transportation.
- To avoid damage, remove the packaging with care.
- Keep all the accompanying documents.

The system must not be put into operation if the contents are found to be damaged beforehand. Follow the instructions on <https://netilion.endress.com/legal/terms-of-service>. Return the SGC500 when requested to do so by Endress+Hauser. Use the original packaging where possible.

 The device is replaced following consultation with Endress+Hauser and must only be returned upon request.

#### 4.1.1 Scope of delivery

The scope of delivery comprises:

- SGC500
- 1 × power terminal block connector
- 1 × fastening clip for DIN rail mounting
- 1 × dust protection cap
- 1 × documentation

## 4.2 Product identification

### 4.2.1 Nameplate

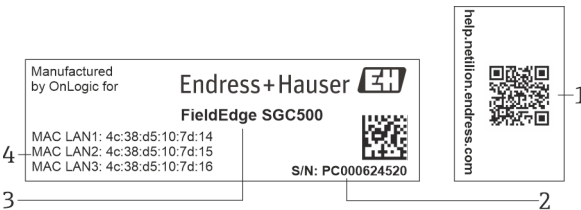

#### 3 SGC500 nameplate

- 1 QR code with link to Netilion help
- 2 Endress+Hauser serial number
- 3 Endress+Hauser product name
- 4 MAC addresses of LAN connections

 Do not use the LAN 2 MAC address, as this port is not used.

## 4.2.2 Manufacturer's address

Hardware	Software
Made by OnLogic for Endress+Hauser OnLogic 35 Thompson St, South Burlington, VT 05403 United States	Endress+Hauser Process Solutions AG Christoph Merian-Ring 12 CH-4153 Reinach Switzerland <a href="http://www.endress.com">www.endress.com</a>

## 4.3 Storage and transport



Always use the original packaging when transporting the product.

### 4.3.1 Ambient temperature range

-25 to 70 °C (-13 to 158 °F)

### 4.3.2 Storage temperature

-40 to 80 °C (-40 to 176 °F)

### 4.3.3 Humidity

0 to 90 %, non-condensing

### 4.3.4 Vibration resistance

Tested acc. to

- IEC 60068-2-64
- MIL-STD-810G

### 4.3.5 Shock resistance

Tested acc. to

- IEC 60068-2-27
- MIL-STD-810G

## 5 Installation

### 5.1 Installation conditions

Please note the following to ensure correct operation of the SGC500:

- Supply voltage 9 to 36 V<sub>DC</sub>
- Ambient temperature range -25 to 70 °C (-13 to 158 °F)
- Relative humidity 0 to 90 % non-condensing
- Vibration resistance as per IEC 60068-2-64



When selecting the location of the SGC500, ensure that it is possible to connect to the Internet and the field network.

## 5.2 Mounting the device

Dimensions of the SGC500: 56 mm (2.20 in) · 154 mm (6.06 in) · 119 mm (4.69 in)

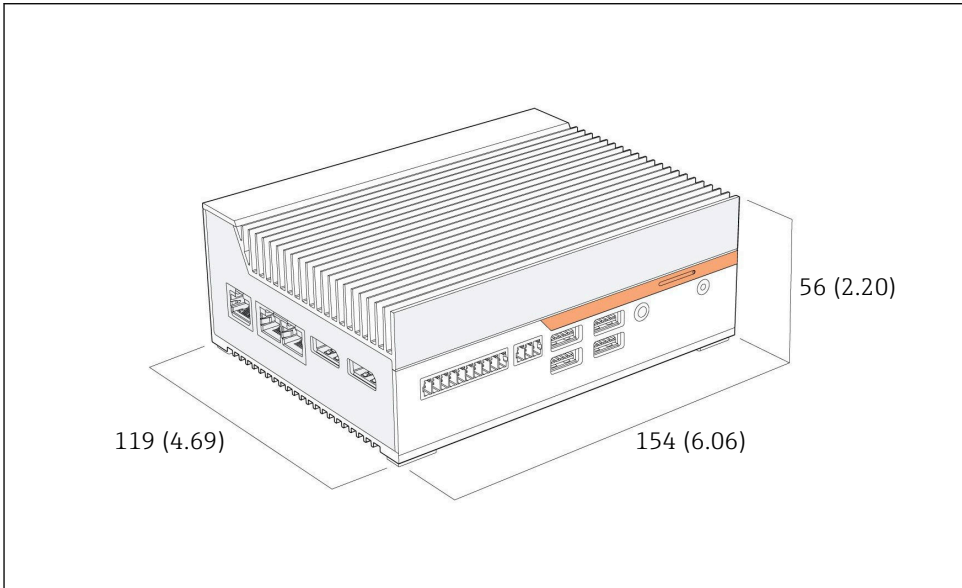

 4 Dimensions of the SGC500, engineering unit: mm (in)

### Mounting on DIN rails

1. Fix the DIN rail clip supplied on the SGC500.
2. Mount the SGC500 on a DIN rail in a system cabinet.

 Sufficient space around the SGC500 is required for heat dissipation.

## 5.3 Post-installation check

Are the mounted components undamaged (visual inspection)?	<input type="checkbox"/>
Do all the components meet the required specifications? For example: <ul style="list-style-type: none"> <li>▪ Ambient temperature</li> <li>▪ Humidity</li> </ul>	<input type="checkbox"/>
Are all the securing screws tightened securely?	<input type="checkbox"/>
Is the SGC500 correctly mounted on the DIN rail?	<input type="checkbox"/>
Is the SGC500 mounted for optimum heat dissipation with vertically aligned cooling fins?	<input type="checkbox"/>

Is the power supply correct?	<input type="checkbox"/>
Is the polarity of the power supply correct?	<input type="checkbox"/>

## 6 Electrical connection

### 6.1 Connection conditions

The following conditions must be met:

- Ensure the cable is de-energized when connecting to the SGC500
- Please follow the connection information in this manual
- Supply voltage 9 to 36 V<sub>DC</sub>
- Permitted voltage fluctuation  $\pm 10\%$

### 6.2 Connecting the device

#### 6.2.1 Connecting the supply voltage

##### NOTICE

##### Damage to device

- ▶ Do not open the housing of the FieldEdge SGC500.

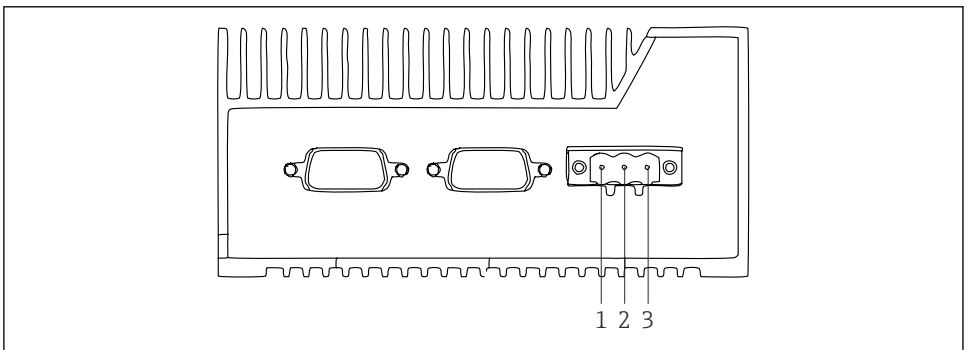

5 Power supply at the SGC500, socket for 3-pin connector



- 1 Supply voltage, negative pole
- 2 Not used
- 3 Supply voltage, positive pole

A 3-pin connector for the supply voltage is included in the scope of supply.

#### Connecting the 3-pin connector for the supply voltage

1. Connect the negative pole of the supply voltage to terminal 1 (-).

2. Connect the positive pole of the supply voltage to terminal 3 (+).

 Connecting the supply voltage: →  16

### 6.2.2 Connecting the LAN ports

 Connecting the LAN ports: →  16

## 6.3 Post-connection check

Is the device undamaged (visual inspection)? Are the cables undamaged (visual inspection)?	<input type="checkbox"/>
Does the supply voltage match the specification on the nameplate?	<input type="checkbox"/>
Was the supply voltage connected correctly?	<input type="checkbox"/>

# 7 Operation options

The SGC500 can be connected for local configuration via a notebook with a network connection. The SGC500 can be configured with a Web browser like Chrome or Firefox.

# 8 System integration

System integration is via Netilion and is performed automatically in the background, as described. As soon as an Internet connection has been established for the SGC500, the SGC500 is visible in the Netilion Cloud and can be controlled from there.

# 9 Commissioning

## 9.1 Connecting the SGC500

### 9.1.1 Separate connections for Internet and field network

-  We recommend using different networks for the Internet and the field network, as described in this section.
- The system firewall settings do not block authorized requests from the Internet to the field network and allow access to Netilion via [https://\\*.netilion.endress.com](https://*.netilion.endress.com). <https://api.netilion.endress.com> and <https://downloads.netilion.endress.com> are used.



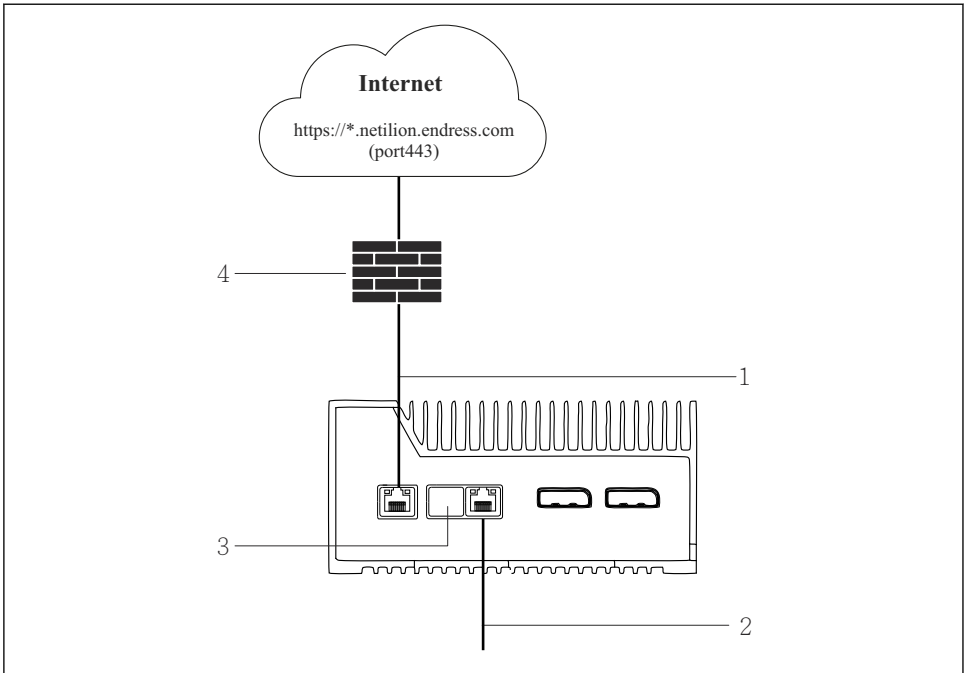

A0044505

#### 6 Separate connections for Internet and field network

- 1 LAN1 (WAN 1 – cloud) for connection to the Internet
- 2 LAN3 (LAN2 – field) for connection to the fieldbus
- 3 LAN2 not used
- 4 System firewall



The Ethernet cables are not included in the scope of delivery.

1. Connect the Ethernet cable for the Internet connection to LAN1 (WAN 1 – cloud) of the SGC500.
2. Connect the Ethernet cable for the field network to LAN3 (LAN2 – field) of the SGC500.
3. Place a dust cover on the LAN connection that is not in use.
4. Connect the supply voltage. →  15
  - ↳ The power LED on the SGC500 must be lit blue.

### 9.1.2 Common connection for Internet and field network

- i** We recommend you use different networks for the Internet and field network.
  - 16
- If only one network is set up for the Internet and the field network, the LAN1 connection (WAN 1 – cloud) must be used.
- The system firewall settings do not block authorized requests from the Internet to the field network and allow access to Netilion via [https://\\*.netilion.endress.com](https://*.netilion.endress.com).  
<https://api.netilion.endress.com> and <https://downloads.netilion.endress.com> are used.

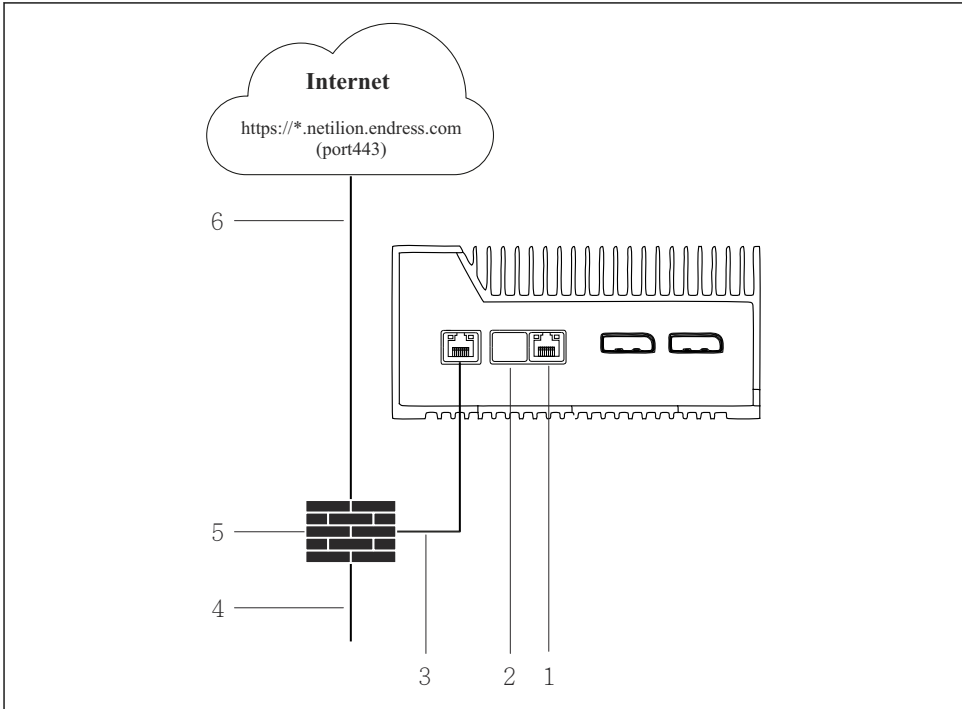

A0044631

#### **7** Common connection for Internet and field network

- 1 LAN3 not used
- 2 LAN2 not used
- 3 LAN1 (WAN 1 – cloud)
- 4 Field network
- 5 System firewall
- 6 Internet connection

The Ethernet cables are not included in the scope of delivery.

- 1.** Connect the Ethernet cable from the system firewall to LAN1 (WAN 1 – cloud) of the SGC500.

2. Place a dust cover on the LAN connections that are not in use.
3. Connect the field network to the system firewall.
4. Connect the Internet to the system firewall.
5. Connect the supply voltage. →  15
  - ↳ The power LED on the SGC500 must be lit blue.



If the LAN1 connection only is used, the EtherNet/IP connection is not supported.

## 9.2 Automatically connecting the SGC500 to the Netilion Cloud

### Requirements

Access to Endress+Hauser Netilion is established.

1. Log in to Endress+Hauser Netilion <https://netilion.endress.com/app/id/>.
2. In Netilion, use the navigation function to open the **Edge Devices** page.
3. Select the SGC500 on the **Edge Devices** page.
  - ↳ When the SGC500 has connected to the Netilion Cloud, a green dot appears next to the SGC500.



- If the SGC500 is not displayed with a green dot, wait a few minutes and refresh the list of edge devices (F5).
- If the SGC500 is still not displayed with a green dot, manually connect the SGC500 to the Netilion Cloud →  19.

## 9.3 Manually connecting the SGC500 to the Netilion Cloud



If automatic connection of the SGC500 to the Netilion Cloud has failed, connect the SGC500 to the Netilion Cloud manually.

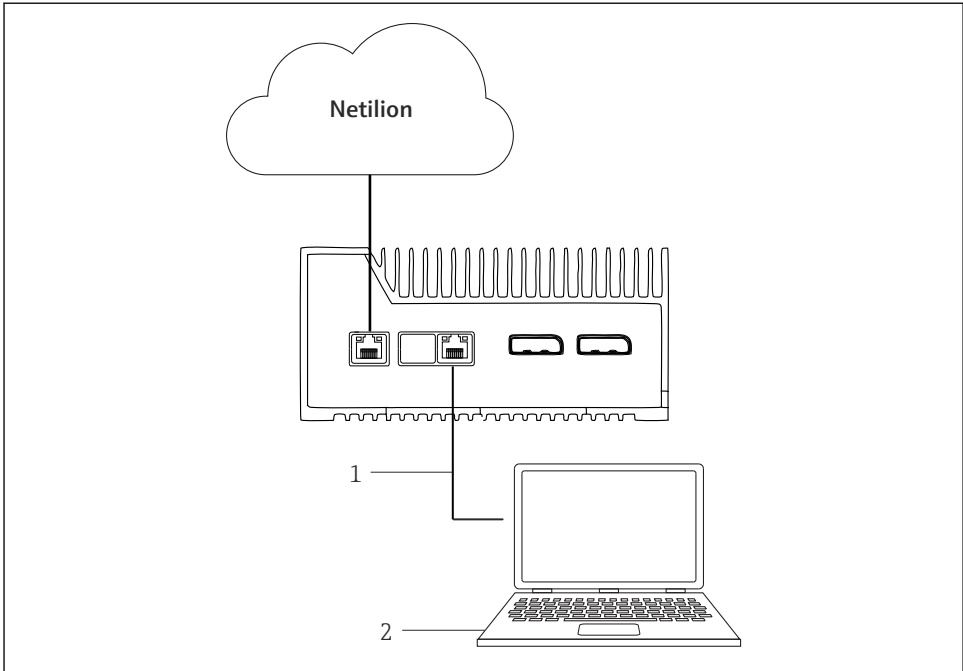

A0042272

- 1 Ethernet cable between notebook and LAN3 (LAN2 – field)
- 2 Notebook with Web browser for the configuration

1. Connect the notebook via an Ethernet cable to LAN3 (LAN2 – field) of the SGC500.
2. Open a web browser.
3. Enter the URL **169.254.1.1**.
  - ↳ The SGC500 app opens.
4. Log in. User name: *admin*. Password: *serial number of the SGC500*.

5. Follow the instructions of the SGC500 app and make the configuration.



If connection to Netilion fails, check DNS availability.

Check the following DNS scenarios in the SGC500 network:

**Scenario 1:** SGC500 Internet access via proxy server (recommended).

**1a:** SGC500 can reach the proxy server with the proxy IP address. The proxy is configured in the SGC500 app with its IP address. The SGC500 does not require a DNS configuration.

**1b:** SGC500 can reach the proxy server with the proxy name. The proxy is configured in the SGC500 app with its proxy name. The SGC500 requires access to a DNS server to resolve the proxy name.

**Scenario 2:** The SGC500 can access [https://\\*.netilion.endress.com](https://*.netilion.endress.com) directly, no proxy server is available. This is not recommended as there is no firewall. The SGC500 requires access to a DNS server to resolve [\\*.netilion.endress.com](https://*.netilion.endress.com).

6. As soon as an Internet connection has been established, disconnect the Ethernet cable at the SGC500 from LAN3 (LAN2 – field).
7. Connect the Ethernet cable for the field network to LAN3 (LAN2 – field) of the SGC500.
8. Connect the SGC500 with the Netilion Cloud. → 📄 19



The serial number can be found on the nameplate and in the "Software updates" → 📄 25 section.

If it is not possible to connect to the SGC500 app:

1. Check the TCP/IP settings on the connected notebook.
2. Permit the automatic assignment of an IP address (DHCP) or the assignment of a fixed IP address.
3. Alternatively, configure the IP address **169.254.1.2** with subnet mask **255.255.0.0**.
4. Also check that the use of a http proxy is not enabled.
5. Enter the address on a notebook in the same network <https://api.netilion.endress.com/status>.
  - ↳ The status *I am alive* confirms unlimited Internet access to [netilion.endress.com](https://netilion.endress.com).



Contact the IT administrator if no connection can be established from the SGC500 to Netilion.

## 9.4 Connecting to the field network

### Requirements

- Access to Endress+Hauser Netilion is established.
- The SGC500 is visible in the Netilion Cloud.

1. Log in to Endress+Hauser Netilion <https://netilion.endress.com/app/id/>.

2. Use the navigation in Netilion to open the **Edge Devices** page.
3. On the **Edge Devices** page, click the relevant **SGC500**.
  - ↳ The "Edge Device Details" page is displayed.
4. In the "Network Interfaces" section, click **LAN2 – field (LAN3)**.
  - ↳ The "Network Interface Details" page is displayed.
5. Click **Edit**.
6. Configure the IP settings of the field network.
7. Save the settings by clicking **Save**.
8. Wait for the settings to update.
9. Use **F5** to refresh the list of edge devices.
  - ↳ The SGC500 is displayed with a green dot.
10. Fieldbus via fieldbus gateway: → 📄 22. EtherNet/IP: → 📄 23

 Connecting to field devices or field gateways is only possible in the configured field network. Subnet routing is not supported.

## 9.5 Connecting to the field gateway

 This section is not applicable to EtherNet/IP.

### Requirements

- Access to Endress+Hauser Netilion is established.
- The SGC500 is connected to the Netilion Cloud.

1. Log in to Endress+Hauser Netilion <https://netilion.endress.com/app/id/>.
2. In Netilion, use the navigation function to open the **Edge Devices** page.
3. On the **Edge Devices** page, click the relevant **SGC500**.
  - ↳ The "Edge Device Details" page is displayed.
4. In the "Field Gateways" section, click **Create**.
  - ↳ The "Create Field Gateway" page is displayed.
5. Select the field gateway type.
6. Enter the settings for the field gateway.
7. Save the settings by clicking **Save**.
8. Wait for the settings to update.
9. Use **F5** to refresh the list of edge devices.
  - ↳ The SGC500 is displayed with a green dot.  
The configured field gateway is connected to the SGC500.
10. Repeat these steps if an additional field gateway is required.
  - ↳ The SGC500 is now ready for use with Netilion Services.

## 9.6 Connecting to the EtherNet/IP



This section is not applicable to fieldbuses that are connected to the SGC500 via a field gateway.

### Requirements

- Access to Endress+Hauser Netilion is established.
- The SGC500 is connected to the Netilion Cloud.

1. Log in to Endress+Hauser Netilion <https://netilion.endress.com/app/id/>.
2. In Netilion, use the Navigation function to open the **Edge Devices** page.
3. On the **Edge Devices** page, click the relevant **SGC500**.
  - ↳ The "Edge Device Details" page is displayed.
4. Click **Edit**.
  - ↳ The "Edge Device Details" page is displayed.
5. In the "EtherNet/IP Activation Status" section, change the status to **Activate**.
6. Save the settings by clicking **Save**.
7. Wait for the settings to update.
8. Use **F5** to refresh the list of edge devices.
  - ↳ The SGC500 is displayed with a green dot.  
The Ethernet field network is connected to the SGC500. The SGC500 is now ready for use with Netilion Services.

## 10 FieldEdge SGC500 and Netilion

### 10.1 Using the FieldEdge SGC500 in Netilion

The following connections are possible:

- Netilion Services or
- Netilion Connect

#### Netilion Services



For detailed information on Netilion Services, see <https://netilion.endress.com>

#### Netilion Connect





- For detailed information on Netilion Connect, see
- For documentation for accessing field device data via API, see <https://developer.netilion.endress.com/discover>
  - For documentation for accessing field device data via API, see <https://api.netilion.endress.com/doc/v1/> or QR code.



 8 *Information for accessing field device data via QR code.*

## 10.2 About Netilion

Netilion is Endress+Hauser's IIoT ecosystem that allows smart and networked applications in the Industrial Internet of Things. Cutting-edge and secure Internet technologies enable these digital services, combined with the technologies of industrial production processes. All our Netilion Services are easy and straightforward to put into operation.

More information about Netilion	Netilion Help
<div data-bbox="150 587 418 759" style="border: 1px solid black; padding: 10px; text-align: center;">   <a href="https://netilion.endress.com">netilion.endress.com</a> </div>	<div data-bbox="628 587 897 759" style="border: 1px solid black; padding: 10px; text-align: center;">   <a href="https://help.netilion.endress.com">help.netilion.endress.com</a> </div>

## 11 Maintenance

Remove dirt from the housing regularly.

Observe the following when cleaning:

- Use a damp cloth
- Do not use chemical additives
- No local maintenance is necessary, as updates run automatically in the background.



## 12 Diagnostics and troubleshooting

### General troubleshooting

Fault	Troubleshooting
The FieldEdge does not appear in the Netilion Cloud	<ul style="list-style-type: none"> <li>▪ Check Internet connection</li> <li>▪ Check Ethernet cable connection →  16</li> <li>▪ Check IP settings of the FieldEdge</li> <li>▪ Check firewall</li> </ul>
The FieldEdge appears in the Netilion Cloud, but no field data are transmitted.	<ul style="list-style-type: none"> <li>▪ Check field network connection</li> <li>▪ Check settings for field gateway</li> </ul>



Detailed information on Netilion Connect:

For documentation for accessing field device data via API, see:

<https://developer.netilion.endress.com/discover>

## 13 Software updates



Software updates are an integral part of Netilion Services and are automatically transmitted to the SGC500. Interaction or approval by the user is not required.

## 14 Serial number SGC500



## 15 Repairs

### 15.1 General notes

Do not perform repairs on the device. Contact Endress+Hauser Service in the event of a problem or malfunction.

## 15.2 Return and / or cancellation of Netilion Subscription

The device must be returned to Endress+Hauser in the following cases:

- After canceling the Netilion Subscription
- If a request is sent from Endress+Hauser Service in the event of a device change

## 15.3 Disposal

Only dispose of the device with the approval of Endress+Hauser Service. To ensure safe disposal, you must follow the instructions of Endress+Hauser Service.





71551532

[www.addresses.endress.com](http://www.addresses.endress.com)

---