

Brief Operating Instructions

RN42

1-channel active barrier with wide range power supply for the safe separation of 0/4 to 20 mA standard signal circuits, HART-transparent



These Instructions are Brief Operating Instructions; they are not a substitute for the Operating Instructions pertaining to the device.

For detailed information, refer to the Operating Instructions and other documentation.





Available for all device versions via:

- Internet: www.endress.com/deviceviewer
- Smart phone/Tablet: Endress+Hauser Operations App











1 About this document

1.1 Symbols





1.1.1 Safety symbols

 DANGER This symbol alerts you to a dangerous situation. Failure to avoid this situation will result in serious or fatal injury.	 WARNING This symbol alerts you to a dangerous situation. Failure to avoid this situation can result in serious or fatal injury.
 CAUTION This symbol alerts you to a dangerous situation. Failure to avoid this situation can result in minor or medium injury.	 NOTICE This symbol contains information on procedures and other facts which do not result in personal injury.

1.1.2 Symbols for certain types of information

Symbol	Meaning	Symbol	Meaning
	Permitted Procedures, processes or actions that are permitted.		Preferred Procedures, processes or actions that are preferred.
	Forbidden Procedures, processes or actions that are forbidden.		Tip Indicates additional information.
	Reference to documentation		Reference to page
	Reference to graphic		Series of steps
	Result of a step		Visual inspection



1.1.3 Electrical symbols

	Direct current		Alternating current
	Direct current and alternating current		Ground connection A grounded terminal which, as far as the operator is concerned, is grounded via a grounding system.

1.1.4 Symbols in graphics

	Item numbers		Views
--	--------------	---	-------

1.1.5 Symbols at the device

	<p>Warning Observe the safety instructions contained in the associated Operating Instructions</p>
	<p>Equipment protected throughout by DOUBLE INSULATION or REINFORCED INSULATION</p>

1.2 Registered trademarks

HART®

Registered trademark of the FieldComm Group, Austin, Texas, USA

2 Basic safety instructions

2.1 Requirements for the personnel

The personnel must fulfill the following requirements for its tasks:

- ▶ Trained, qualified specialists must have a relevant qualification for this specific function and task.
- ▶ Are authorized by the plant owner/operator.
- ▶ Are familiar with federal/national regulations.
- ▶ Before starting work, read and understand the instructions in the manual and supplementary documentation as well as the certificates (depending on the application).
- ▶ Follow instructions and comply with basic conditions.

2.2 Intended use

2.2.1 Active barrier

The active barrier is used for the safe isolation of 0/4 to 20 mA standard signal circuits. An intrinsically safe version is optionally available for operation in Zone 2. The device is designed for installation on DIN rails in accordance with IEC 60715.

A use in a manner not specified by the manufacturer's manual may impair the safety.

2.2.2 Product liability

The manufacturer does not accept any responsibility for damage that results from non-designated use and from failure to comply with the instructions in this manual.

2.3 Workplace safety

For work on and with the device:

- ▶ Wear the required personal protective equipment according to federal/national regulations.

2.4 Operational safety

Risk of injury!

- ▶ Operate the device only if it is in proper technical condition, free from errors and faults.
- ▶ The operator is responsible for interference-free operation of the device.

Hazardous area

To eliminate danger to persons or the facility when the device is used in the hazardous area (e.g. explosion protection):

- ▶ Check the nameplate to verify if the device ordered can be put to its intended use in the hazardous area.
- ▶ Observe the specifications in the separate supplementary documentation that is an integral part of these instructions.

2.5 Product safety

This device is designed in accordance with good engineering practice to meet state-of-the-art safety requirements, has been tested, and left the factory in a condition in which it is safe to operate.

2.6 Installation instructions

- The device's IP20 degree of protection is intended for a clean and dry environment.
- Do not expose the device to mechanical and/or thermal stress that exceeds the specified limits.
- The device is intended for installation in a cabinet or similar housing. The device may only be operated as an installed device.
- To protect against mechanical or electrical damage, the device must be installed in an appropriate housing with a suitable degree of protection according to IEC/EN 60529.
- The device fulfills the EMC regulations for the industrial sector.

3 Product description

3.1 Product design

3.1.1 Active barrier, 1-channel

- The active barrier is used for the transmission and galvanic isolation of 0/4 to 20 mA/HART signals. The device has an active/passive current input to which a 2- or 4-wire transmitter can be directly connected. The output of the device can be operated actively or passively. The current signal is then available to the PLC / controller or to other instrumentation at plug-in screw terminals or optional push-in terminals.
- HART communication signals are transmitted bidirectionally by the device. Connection sockets for connecting HART communicators are integrated into the front of the device.
- The device is optionally available as an "associated apparatus", which allows devices to be connected in Ex Zone 0/20 [ia] and operated in Ex Zone 2 [ec]. 2-wire transmitters are supplied with power, and transmit analog 0/4 to 20 mA/HART measured values from the hazardous area to the non-hazardous area. These devices are accompanied by separate Ex documentation, which is an integral part of this manual. Compliance with the installation instructions and connection data in this documentation is mandatory!

4 Incoming acceptance and product identification

4.1 Incoming acceptance

Check the following during incoming acceptance:

- Are the order codes on the delivery note and the product sticker identical?
- Are the goods undamaged?
- Do the data on the nameplate match the ordering information on the delivery note?



If one of these conditions is not met, please contact the manufacturer's sales office.

4.2 Product identification

The following options are available for identification of the device:

- Nameplate specifications
- Extended order code with breakdown of the device features on the delivery note

4.2.1 Name and address of manufacturer

Name of manufacturer:	Endress+Hauser Wetzler GmbH + Co. KG
Address of manufacturer:	Obere Wank 1, D-87484 Nesselwang
Model/type reference:	RN42

4.3 Certificates and approvals

 For certificates and approvals valid for the device: see the data on the nameplate

 Approval-related data and documents: www.endress.com/deviceviewer → (enter the serial number)

4.3.1 Functional safety

A SIL version of the device is optionally available. It can be used in safety equipment in accordance with IEC 61508 up to SIL 2 (SC 3) .

 Please refer to Safety Manual FY01034K for the use of the device in safety instrumented systems according to IEC 61508.

5 Mounting

5.1 Mounting requirements

5.1.1 Dimensions

Width (W) x length (L) x height (H) (with terminals): 17.5 mm (0.69 in) x 116 mm (4.57 in) x 107.5 mm (4.23 in)

5.1.2 Mounting location

The device is designed for installation on 35 mm (1.38 in) DIN rails in accordance with IEC 60715 (TH35).

NOTICE

- ▶ When using in hazardous areas, the limit values of the certificates and approvals must be observed.

5.2 Important ambient conditions

Ambient temperature range	-40 to 60 °C (-40 to 140 °F)	Storage temperature	-40 to 80 °C (-40 to 176 °F)
Degree of protection	IP 20	Overvoltage category	II
Pollution degree	2	Humidity	5 to 95 %
Operating altitude, hazardous area version	≤ 2 000 m (6 562 ft)	Operating altitude, non-hazardous area version	≤ 4 000 m (13 123 ft)
		Insulation class	Class II

5.3 Installing a DIN rail device

The device can be installed in any position (horizontal or vertical) on the DIN rail without lateral clearance from neighboring devices. No tools are required for installation. The use of

end brackets (type WEW "35/1" or similar) on the DIN rail is recommended as an end support for the device.

- i** When installing several devices side by side, it is important to ensure that the maximum side wall temperature of 80 °C (176 °F) of the individual devices is not exceeded. If this cannot be guaranteed, mount the devices at a distance from one another or ensure sufficient cooling.

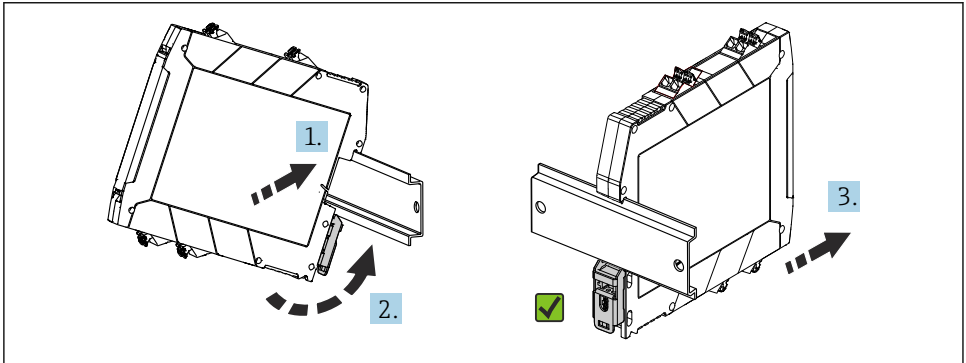

A0041736

- i** 1 *Installing on DIN rail*

6 Electrical connection

6.1 Connecting requirements

A flat-blade screwdriver is required to establish an electrical connection to screw or push-in terminals.

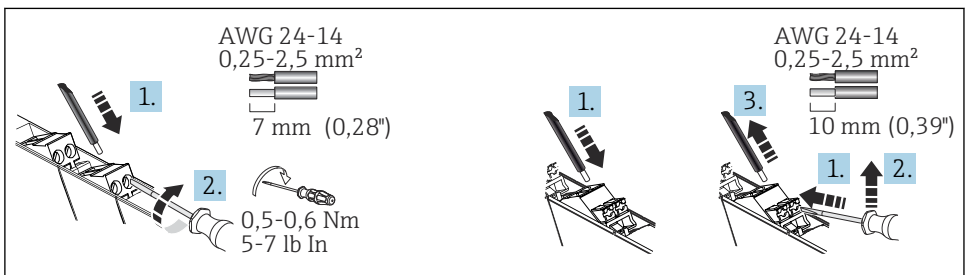

A0040201

- i** 2 *Electrical connection using screw terminals (left) and push-in terminals (right)*

CAUTION**Destruction of parts of the electronics**

- ▶ Switch off the power supply before installing and connecting the device.

NOTICE**Destruction or malfunction of parts of the electronics**

- ▶  ESD - Electrostatic discharge. Protect the terminals and HART sockets on the front from electrostatic discharge.
- ▶ A shielded cable is recommended for HART communication. Observe grounding concept of the plant.



Only use copper cables with a minimum temperature rating of 75 °C (167 °F) as the connecting cables.

6.2 Special connection instructions

- Disconnecting devices and auxiliary circuit protective systems with suitable AC or DC values must be provided within reach in the building installation.
- A switch/power circuit breaker must be provided close to the device and clearly marked as a disconnecting unit for this device.
- A circuit breaker (nominal current ≤ 10 A; break capacity 6 kA; e.g. type B) must be available within reach for the supply line.

6.3 Important connection data

6.3.1 Performance characteristics

Power supply ¹⁾

Supply voltage	24 to 230 V _{AC/DC} (-20% / +10%, 0/50/60 Hz)
Power consumption	≤ 4.9 VA / 2.4 W (20 mA); ≤ 5 VA / 2.5 W (22 mA)
Power loss	≤ 2 W (20 mA); ≤ 2.1 W (22 mA)
Current consumption at 24 V _{DC}	≤ 0.1 A (20 mA); ≤ 0.1 A (22 mA)
Current consumption at 230 V _{AC}	≤ 0.02 A (20 mA); ≤ 0.02 A (22 mA)

- 1) The data apply for the following operating scenario: input active / output active / output load 0 Ω. When external voltages are connected to the output, the power loss in the device may increase. The power loss in the device can be reduced by connecting an external output load.

6.3.2 Input data

Input signal range (underrange / overrange)	0 to 22 mA
Function range, input signal	0/4 to 20 mA
Transmitter supply voltage	≥ 16.5 V / (20 mA)

6.3.3 Output data

Output signal range (underrange/ overrange)	0 to 22 mA
Function range, output signal	0/4 to 20 mA
Transmission behavior	1:1 to input signal
Step response (10 to 90 %)	≤ 1 ms
Load	$\leq 500 \Omega$ (for active mode)
Transmissible communication protocols	HART

Accuracies

Transmission error max. (0 to 20.5 mA)	$< 0.1 \%$ / of full scale value ($< 20 \mu\text{A}$)
Temperature coefficient	$< 0.01 \% / \text{K}$

Galvanic isolation

Power supply to input / output	Testing voltage: $3\,000 V_{AC}$ 50 Hz, 1 min
Input to output	Testing voltage: $1\,500 V_{AC}$ 50 Hz, 1 min



For detailed technical data, see the Operating Instructions

6.4 Quick wiring guide

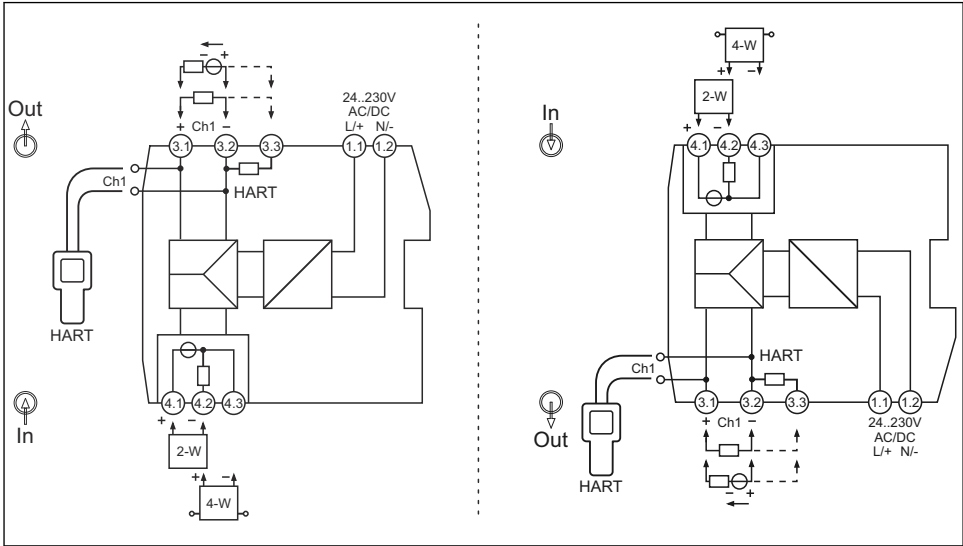

A0045153

3 Terminal assignment, left: power supply top; right: power supply bottom (option)

i HART communicators can be connected to the HART connection sockets. Ensure that there is an adequate external load ($\geq 230 \Omega$) in the output circuit. If the external load is not sufficient, an internal 250Ω communication resistor can be added to the measuring loop via the alternative terminal assignment (terminal 3.3.) to use the HART connection sockets.

6.5 Connecting the supply voltage

The power is supplied via terminals 1.1 and 1.2.

6.6 Post-connection check

Device health and specifications	Notes
Are the device and cables undamaged (visual check)?	--
Do the ambient conditions match the device specification (e.g. ambient temperature, measuring range, etc.)?	See "Technical data"
Electrical connection	Notes
Does the supply voltage match the information on the nameplate?	Active barrier: $U = 24$ to 230 V

Device health and specifications	Notes
Are the power supply and signal cables connected correctly?	--
Are all the screw terminals well tightened and have the connections of the push-in terminals been checked?	--

7 Display and operating elements

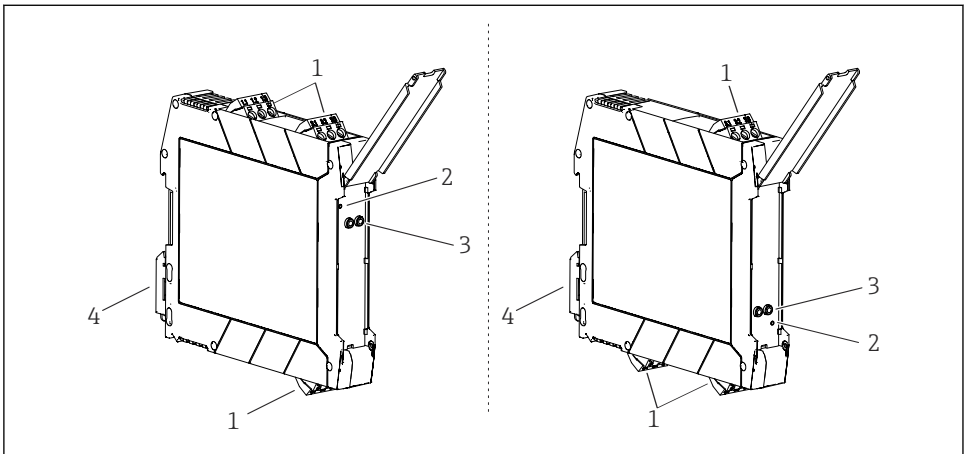

A0045155

4 Display and operating elements, left: power supply top; right: power supply bottom (option)

- 1 Plug-in screw or push-in terminal
- 2 Green LED "On", power supply
- 3 Connection sockets for HART communication (channel 1)
- 4 DIN rail clip for DIN rail mounting

7.1 Local operation

7.1.1 Hardware settings / configuration

No manual hardware settings are required at the device for commissioning.

Attention must be paid to the different terminal assignment when connecting 2/4-wire transmitters. At the output side, the connected system is detected and automatic switching takes place between the active and passive mode.

8 Commissioning

8.1 Post-installation check

Before commissioning the device, ensure that all post-mounting and post-connection checks have been carried out.

NOTICE

- ▶ Before commissioning the device, make sure that the supply voltage matches the voltage specifications on the nameplate. Failure to perform these checks may result in damage to the device caused by the incorrect supply voltage.

8.2 Switching on the device

Switch on the supply voltage. The green LED display on the front of the device indicates that the device is operational.



To prevent incorrect wiring, the output current should be verified when simulating a high alarm at the input.

9 Maintenance

No special maintenance work is required for the device.

Cleaning

A clean, dry cloth can be used to clean the device.



71548295

www.addresses.endress.com
