

# Safety Instructions

## Micropilot

### FMR60, FMR62, FMR67

4-20 mA HART

Ex ec IIC T6...T1 Gc

Ex ic IIC T6...T1 Gc



Document: XA01621F-C

Safety instructions for electrical apparatus for explosion-hazardous areas → 3

Document: XA01621F-C

Temperature tables → 15



# Micropilot FMR60, FMR62, FMR67

4-20 mA HART

## Table of contents

Associated documentation . . . . .	4
Supplementary documentation . . . . .	4
Manufacturer's certificates . . . . .	4
Manufacturer address . . . . .	4
Extended order code . . . . .	4
Safety instructions: General . . . . .	8
Safety instructions: Special conditions . . . . .	8
Safety instructions: Installation . . . . .	9
Temperature tables . . . . .	10
Connection data . . . . .	11

<b>Associated documentation</b>	<p>This document is an integral part of the following Operating Instructions:</p> <ul style="list-style-type: none"> <li>■ BA01618F/00 (FMR60)</li> <li>■ BA01619F/00 (FMR62)</li> <li>■ BA01620F/00 (FMR67)</li> </ul>										
<b>Supplementary documentation</b>	<p>Explosion-protection brochure: CP00021Z/11</p> <p>The Explosion-protection brochure is available:</p> <ul style="list-style-type: none"> <li>■ In the download area of the Endress+Hauser website:  <a href="http://www.endress.com">www.endress.com</a> -&gt; Downloads -&gt; Brochures and Catalogs -&gt; Text Search: CP00021Z</li> <li>■ On the CD for devices with CD-based documentation</li> </ul>										
<b>Manufacturer's certificates</b>	<p><b>Certificate of Conformity</b></p> <p>Certificate number: TÜV 17.1033 X</p> <p>Affixing the certificate number certifies conformity with the following standards (depending on the device version):</p> <ul style="list-style-type: none"> <li>■ ABNT NBR IEC 60079-0 : 2013</li> <li>■ ABNT NBR IEC 60079-7 : 2018</li> <li>■ ABNT NBR IEC 60079-11 : 2013</li> </ul>										
<b>Manufacturer address</b>	<p>Endress+Hauser SE+Co. KG Hauptstraße 1 79689 Maulburg, Germany Address of the manufacturing plant: See nameplate.</p>										
<b>Extended order code</b>	<p>The extended order code is indicated on the nameplate, which is affixed to the device in such a way that it is clearly visible. Additional information about the nameplate is provided in the associated Operating Instructions.</p> <p><b>Structure of the extended order code</b></p> <table style="margin-left: auto; margin-right: auto; border: none;"> <tr> <td style="text-align: center;">FMR6x</td> <td style="text-align: center;">-</td> <td style="text-align: center;">*****</td> <td style="text-align: center;">+</td> <td style="text-align: center;">A*B*C*D*E*F*G*..</td> </tr> <tr> <td style="text-align: center;"><i>(Device type)</i></td> <td></td> <td style="text-align: center;"><i>(Basic specifications)</i></td> <td></td> <td style="text-align: center;"><i>(Optional specifications)</i></td> </tr> </table> <p>* = Placeholder At this position, an option (number or letter) selected from the specification is displayed instead of the placeholders.</p> <p><i>Basic specifications</i></p> <p>The features that are absolutely essential for the device (mandatory features) are specified in the basic specifications. The number of positions depends on the number of features available. The selected option of a feature can consist of several positions.</p> <p><i>Optional specifications</i></p> <p>The optional specifications describe additional features for the device (optional features). The number of positions depends on the number of features available. The features have a 2-digit structure to aid identification (e.g. JA). The first digit (ID) stands for the feature group and consists of a number or a letter (e.g. J = Test, Certificate). The second digit constitutes the value that stands for the feature within the group (e.g. A = 3.1 material (wetted parts), inspection certificate).</p>	FMR6x	-	*****	+	A*B*C*D*E*F*G*..	<i>(Device type)</i>		<i>(Basic specifications)</i>		<i>(Optional specifications)</i>
FMR6x	-	*****	+	A*B*C*D*E*F*G*..							
<i>(Device type)</i>		<i>(Basic specifications)</i>		<i>(Optional specifications)</i>							

More detailed information about the device is provided in the following tables. These tables describe the individual positions and IDs in the extended order code which are relevant to hazardous locations.

**Extended order code: Micropilot**

-  The following specifications reproduce an extract from the product structure and are used to assign:
- This documentation to the device (using the extended order code on the nameplate).
  - The device options cited in the document.

*Device type*

FMR60, FMR62, FMR67

*Basic specifications*

Position 1, 2 (Approval)		
Selected option		Description
FMR6x	MG <sup>1) 2)</sup>	INMETRO Ex ec IIC T6...T1 Gc
	MH <sup>3)</sup>	INMETRO Ex ic IIC T6...T1 Gc

- 1) Combination with Position 4 (Display, Operation) = L, M, N in connection with Position 3 (Power Supply, Output) = A is not allowed.
- 2) The designation changes in connection with Position 4 (Display, Operation) = L, M, N and Position 3 (Power Supply, Output) = B, C: Ex ec [ia Ga] IIC T6...T1 Gc. Special version only with Ex e certified entry.
- 3) The designation changes in connection with Position 4 (Display, Operation) = L, M, N and Position 3 (Power Supply, Output) = B, C: Ex ic [ia Ga] IIC T6...T1 Gc

Position 3 (Power Supply, Output)		
Selected option		Description
FMR6x	A	2-wire, 4-20 mA HART
	B	2-wire, 4-20 mA HART, switch output (PFS)
	C	2-wire, 4-20 mA HART, 4 to 20 mA

Position 4 (Display, Operation)		
Selected option		Description
FMR6x	A	Without, via communication
	C	SD02, 4-line, push buttons + data backup function
	E	SD03, 4-line, illum., touch control + data backup function
	L <sup>1)</sup>	Prepared for display FHX50 + M12 connection
	M <sup>1)</sup>	Prepared for display FHX50 + custom connection
	N <sup>2)</sup>	Prepared for display FHX50 + NPT1/2"

- 1) In connection with Position 5 (Housing) = A: Observe the specifications in the "Overvoltage protection" and "Temperature tables" chapters!
- 2) Only in connection with Position 5 (Housing) = B, C

Position 5 (Housing)		
Selected option		Description
FMR6x	A <sup>1)</sup>	GT19 dual compartment, plastic PBT
	C	GT20 dual compartment, Alu, coated
FMR62 FMR67	B	GT18 dual compartment, 316L

1) Only in connection with Position 1, 2 (Approval) = MH

Position 6 (Electrical Connection)		
Selected option		Description
FMR6x	A	Gland M20, IP66/68 NEMA4X/6P
	B	Thread M20, IP66/68 NEMA4X/6P
	C	Thread G1/2, IP66/68 NEMA4X/6P
	D	Thread NPT1/2, IP66/68 NEMA4X/6P
	I <sup>1) 2)</sup>	Plug M12, IP66/68 NEMA4X/6P
	M <sup>1) 2)</sup>	Plug 7/8", IP66/68 NEMA4X/6P

1) Only in connection with Position 1, 2 (Approval) = MH

2) Only in connection with Position 3 (Power Supply, Output) = A

Position 7, 8 (Antenna)		
Selected option		Description
FMR60	GA	Drip-off, PTFE DN50
FMR62	GE	Integrated, PEEK, 3/4"
	GF	Integrated, PEEK, 1-1/2"
	GM	PTFE cladded flush mount DN50
	GN	PTFE cladded flush mount DN80
FMR67	GA	Drip-off, PTFE DN50
	GP	PTFE flush mount DN80

Position 9, 10 (Seal)		
Selected option		Description
FMR60	A3	FKM Viton GLT, -40...80°C/-40...176°F
	A4	FKM Viton GLT, -40...130°C/-40...266°F
	C1	FFKM Kalrez, -20...150°C/-4...302°F
	B4	EPDM, -40...150°C/-40...302°F
FMR62	A5	FKM Viton GLT, -40...150°C/-40...302°F
	A6	FKM Viton GLT, -40...200°C/-40...392°F
	C1	FFKM Kalrez, -20...150°C/-4...302°F
	C2	FFKM Kalrez, -20...200°C/-4...392°F
	F5	PTFE cladded, -40...150°C/-40...302°F
	F6	PTFE cladded, -40...200°C/-40...392°F

Position 9, 10 (Seal)		
Selected option		Description
FMR67	A3	FKM Viton GLT, -40...80°C/-40...176°F
	A5	FKM Viton GLT, -40...150°C/-40...302°F
	A6	FKM Viton GLT, -40...200°C/-40...392°F

Position 11-13 (Process Connection)		
Selected option		Description
FMR60	GGJ	Thread ISO228 G1-1/2, 316L
	RGJ	Thread ANSI MNPT1-1/2, 316L
	XxG	Flange (different sizes), PP
	XxJ	Flange (different sizes), 316L
FMR62	AxK	Flange (different sizes), PTFE>316/316L
	CxK	Flange (different sizes), PTFE>316L
	GxJ	Thread ISO (different sizes), 316L
	KxK	Flange (different sizes), PTFE>316L
	MxK	Slotted-nut (different sizes), PTFE>316L
	RxJ	Thread ANSI (different sizes), 316L
	TxK	Tri-Clamp (different sizes), PTFE>316L
FMR67	Axj	Flange (different sizes), 316/316L
	Cxj	Flange (different sizes), 316L
	GGJ	Thread ISO228 G1-1/2, 316L
	Kxj	Flange (different sizes), 316L
	RGJ	Thread ANSI MNPT1-1/2, 316L
	XxA	Align. device (different sizes)
	XxG	Flange (different sizes), PP
	Xxj	Flange (different sizes), 316L

Position 14 (Air Purge Connection)		
Selected option		Description
FMR67	A <sup>1)</sup>	W/o
	1 <sup>2)</sup>	G1/4
	2 <sup>2)</sup>	NPT1/4
	3 <sup>1)</sup>	Adapter G1/4
	4 <sup>1)</sup>	Adapter NPT1/4

- 1) Only in connection with Position 7, 8 (Antenna) = GA  
2) Only in connection with Position 7, 8 (Antenna) = GP

*Optional specifications*

ID Nx (Accessory Mounted)		
Selected option		Description
FMR6x	NA	Overvoltage protection
	NF <sup>1)</sup>	Bluetooth

1) Only in connection with Position 4 (Display, Operation) = C, E

**Safety instructions: General**

- Staff must meet the following conditions for mounting, electrical installation, commissioning and maintenance of the device:
  - Be suitably qualified for their role and the tasks they perform
  - Be trained in explosion protection
  - Be familiar with national regulations
- Install the device according to the manufacturer's instructions and national regulations.
- Do not operate the device outside the specified electrical, thermal and mechanical parameters.
- Only use the device in media to which the wetted materials have sufficient durability.
- Avoid electrostatic charging:
  - Of plastic surfaces (e.g. housing, sensor element, special varnishing, attached additional plates, ..)
  - Of isolated capacities (e.g. isolated metallic plates)
- Modifications to the device can affect the explosion protection and must be carried out by staff authorized to perform such work by Endress+Hauser.
- Refer to the temperature tables for the relationship between the permitted ambient temperature for the sensor and/or transmitter, depending on the range of application and the temperature class.

**Safety instructions:  
Special conditions**

Permitted ambient temperature range at the electronics housing:  
 $-40\text{ °C} \leq T_a \leq +80\text{ °C}$

- Observe the information in the temperature tables.
- In the case of process connections made of polymeric material or with polymeric coatings, avoid electrostatic charging of the plastic surfaces.
- To avoid electrostatic charging: Do not rub surfaces with a dry cloth.
- In the event of additional or alternative special varnishing on the housing or other metal parts or for adhesive plates:
  - Observe the danger of electrostatic charging and discharge.
  - Do not install in the vicinity of processes ( $\leq 0.5\text{ m}$ ) generating strong electrostatic charges.
- Avoid electrostatic charging of the sensor (e.g. do not rub dry and install outside the filling flow).

*Basic specification, Position 5 (Housing) = A*

Avoid electrostatic charging of the housing (e.g. friction, cleaning, maintenance, strong medium flow).

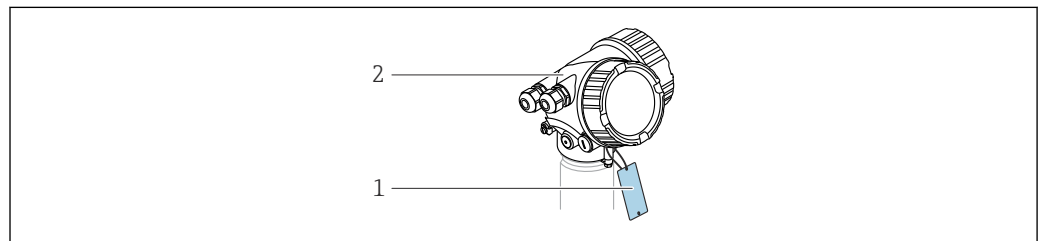

A0032146

1

- 1 *Isolated capacitance:*  
 with one metal plate:  $\leq 3\text{ pF}$  (permitted in all areas for Equipment Groups II and III)  
 with two to three metal plates:  $\leq 10\text{ pF}$  (not permitted in Zone 0 and for Equipment Group IIC)
- 2 *Housing*



## Safety instructions: Installation

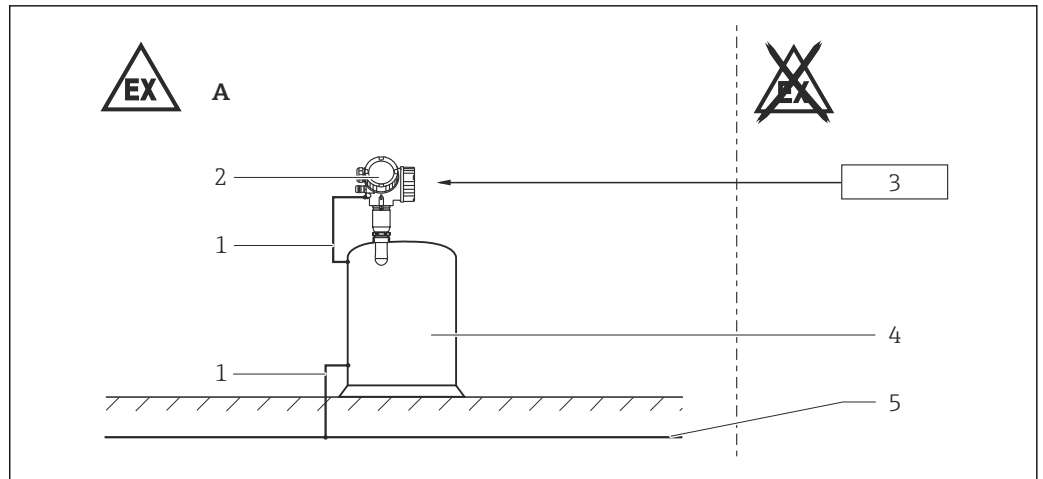

A0031938

### 2

- A Zone 2  
 1 Potential equalization line  
 2 Electronic insert  
 3 Ex ic: Certified associated apparatus; Ex ec: Supply depending upon equipment version  
 4 Tank; Zone 2  
 5 Potential equalization

- After aligning (rotating) the housing, retighten the fixing screw (see Operating Instructions).
- Install the device to exclude any mechanical damage or friction during the application. Pay particular attention to flow conditions and tank fittings.
- After mounting and connecting the antenna, ingress protection of the housing must be at least IP65.
- Perform the following to achieve the degree of protection:
  - Screw the cover tight.
  - Mount the cable entry correctly.
- Continuous service temperature of the connecting cable:  $-40\text{ °C}$  to  $\geq +85\text{ °C}$ ; in accordance with the range of service temperature taking into account additional influences of the process conditions ( $T_{a,\min}$ ), ( $T_{a,\max} + 20\text{ K}$ ).

Basic specification, Position 4 (Display, Operation) = N

Observe the requirements according to IEC/EN 60079-14 for conduit systems and the wiring- and installation instructions of the suitable Safety Instructions (XA). In addition, observe national regulations and standards for conduit systems.

## Intrinsic safety

### Ex ic

Basic specification, Position 1, 2 (Approval) = MH

- The device is only suitable for connection to certified, intrinsically safe equipment with explosion protection Ex ic.
- If the conditions  $U_i > U_o$ , ( $I_i > I_o$ ),  $C_a > C_i + C_{\text{cable}}$  and  $L_a > L_i + L_{\text{cable}}$  are met, the energy-limited installation concept (Ex ic) allows energy-limited devices or associated energy-limited devices to be connected according to the entity concept.
- The intrinsically safe input power circuit of the device is isolated from ground. If the device is only equipped with one input, the dielectric strength of the input is at least  $500\text{ V}_{\text{rms}}$ . If the device is equipped with more than one input, the dielectric strength of each individual input to ground is at least  $500\text{ V}_{\text{rms}}$ , and the dielectric strength of the inputs vis-à-vis one another is also at least  $500\text{ V}_{\text{rms}}$ .
- Observe the pertinent guidelines when interconnecting intrinsically safe circuits.
- The device can be connected to the Endress+Hauser FXA291 service tool: refer to the Operating Instructions and specifications in the "Overvoltage protection" chapter.
- The device can be equipped with the Bluetooth® module: refer to the Operating Instructions and specifications in the "Bluetooth® module" chapter.

**Increased safety****Ex ec**

*Basic specification, Position 1, 2 (Approval) = MG*

- In potentially explosive atmospheres:
  - Do not disconnect electrical connections when energized.
  - Do not connect the service tool (e.g. FXA291).
- The device can be equipped with the Bluetooth® module: refer to the Operating Instructions and specifications in the "Bluetooth® module" chapter.

*Basic specification, Position 5 (Housing) = A*

The housing is not approved for Ex ec explosion protection.

*Cable specification*

Without *Optional specification, ID Nx (Accessory Mounted) = NA*  
(*Overvoltage protection Type OVP10 and Type OVP20*)

<i>Basic specification, Position 3 (Power Supply, Output)</i>	<b>Cross section connecting wire</b>	<b>Stripped insulation</b>
A, B, C	0.5 to 2.5 mm <sup>2</sup>	10 mm

With *Optional specification, ID Nx (Accessory Mounted) = NA*  
(*Overvoltage protection Type OVP10 and Type OVP20*)

<i>Basic specification, Position 3 (Power Supply, Output)</i>	<b>Cross section connecting wire</b>	<b>Tightening torque of terminal screw</b>	<b>Stripped insulation</b>
A, B, C	0.2 to 2.5 mm <sup>2</sup>	0.35 to 0.4 Nm	5 mm

**Potential equalization**

Integrate the device into the local potential equalization.

**Overvoltage protection**

- If an overvoltage protection against atmospheric over voltages is required: no other circuits may leave the housing during normal operation without additional measures.
- For installations which require overvoltage protection to comply with national regulations or standards, install the device using overvoltage protection (e.g. HAW56x from Endress+Hauser).
- Observe the safety instructions of the overvoltage protection.

*Optional specification, ID Nx (Accessory Mounted) = NA*  
(*Overvoltage protection Type OVP10 and Type OVP20*)

The intrinsically safe input power circuit of the device is isolated from ground. If the device is only equipped with one input, the dielectric strength of the input is at least 290 V<sub>rms</sub>. If the device is equipped with more than one input, the dielectric strength of each individual input to ground is at least 290 V<sub>rms</sub>, and the dielectric strength of the inputs vis-à-vis one another is also at least 290 V<sub>rms</sub>.

**Bluetooth® module**

*Optional specification, ID Nx (Accessory Mounted) = NF*

- With Bluetooth® module installed: Use of external hardware not allowed (e.g. external display, service interface).
- The intrinsically safe input power circuit of the Bluetooth® module is isolated from ground.

**Temperature tables**

→ 16

**Connection data****Cable entry: Connection compartment****Ex ic**

Basic specification, Position 1, 2 (Approval) = MH

Not relevant.

**Ex ec**

Basic specification, Position 1, 2 (Approval) = MG

Cable gland: Basic specification, Position 6 (Electrical Connection) = A

Basic specification, Position 5 (Housing) = B, C

preferably for Position 5 (Housing) = B

Thread	Clamping range	Material	Sealing insert	O-ring
M20x1,5	ø 7 to 12 mm	1.4404	NBR	EPDM (ø 17x2)

preferably for Position 5 (Housing) = C

Thread	Clamping range	Material	Sealing insert	O-ring
M20x1,5	ø 8 to 10.5 mm <sup>1)</sup> (ø 6.5 to 13 mm) <sup>2)</sup>	Ms, nickel-plated	LSR (Silicone)	EPDM (ø 17x2)

1) Standard

2) Separate clamping inserts available

- Only suitable for fixed installation. The operator must pay attention to a suitable strain relief of the cable.
- The cable glands are suitable for a low risk of mechanical danger (4 Joule) and must be mounted in a protected position if larger impact energy levels are expected.
- To maintain the ingress protection of the housing: Install the housing cover, cable glands and blind plugs correctly.

**Cable entry: Electronics compartment**

Cable gland: Basic specification, Position 4 (Display, Operation) = M

Not relevant.

**Terminals**

Optional specification, ID Nx (Accessory Mounted) = NA

(Overvoltage protection Type OVP10 and Type OVP20)

When using the internal overvoltage protection: No changes to the connection values.

Optional specification, ID Nx (Accessory Mounted) = NF

When using the Bluetooth® module: No changes to the connection values.

**Ex ic**

Basic specification, Position 1, 2 (Approval) = MH

Power supply and signal circuit with protection type: intrinsic safety Ex ic IIC, Ex ic IIB.

Basic specification, Position 3 (Power Supply, Output) = A

Terminal 1 (+), 2 (-)
Power supply: $U_i = 35 \text{ V}$ $I_i = \text{not applicable}$ (current-controlled circuit) $P_i = \text{not applicable}$ effective inner inductance $L_i = 0$ effective inner capacitance $C_i = 12 \text{ nF}$

Basic specification, Position 3 (Power Supply, Output) = B

Terminal 1 (+), 2 (-)	Terminal 3 (+), 4 (-)
Power supply: $U_i = 35 \text{ V}$ $I_i = \text{not applicable}$ (current-controlled circuit) $P_i = \text{not applicable}$ effective inner inductance $L_i = 0$ effective inner capacitance $C_i = 5 \text{ nF}$	Switch output (PFS): $U_i = 35 \text{ V}$ $I_i = \text{not applicable}$ (current-controlled circuit) $P_i = 1 \text{ W}$ effective inner inductance $L_i = 0$ effective inner capacitance $C_i = 6 \text{ nF}$

Basic specification, Position 3 (Power Supply, Output) = C

Terminal 1 (+), 2 (-)	Terminal 3 (+), 4 (-)
Power supply: $U_i = 30 \text{ V}$ $I_i = \text{not applicable}$ (current-controlled circuit) $P_i = \text{not applicable}$ effective inner inductance $L_i = 0$ effective inner capacitance $C_i = 30 \text{ nF}$	Output 4 to 20 mA: $U_i = 30 \text{ V}$ $I_i = \text{not applicable}$ $P_i = \text{not applicable}$ effective inner inductance $L_i = 0$ effective inner capacitance $C_i = 30 \text{ nF}$

**Service interface (CDI)**

Taking the following values into consideration, the device can be connected to the certified Endress+Hauser FXA291 service tool or a similar interface:

Service interface														
$U_i = 7.3 \text{ V}$ effective inner inductance $L_i = \text{negligible}$ effective inner capacitance $C_i = \text{negligible}$														
$U_o = 7.3 \text{ V}$ $I_o = 60 \text{ mA}$ $P_o = 110 \text{ mW}$														
$L_o \text{ (mH)} =$	5.00	2.00	1.00	0.50	0.20	0.15	0.10	0.05	0.02	0.01	0.005	0.002	0.001	
$C_o \text{ (}\mu\text{F)}^{1)} =$	0.73	1.20	1.60	2.00	2.60	-	3.20	4.00	5.50	7.30	10.00	12.70	12.70	
$C_o \text{ (}\mu\text{F)}^{2)} =$	-	0.49	0.90	1.40	-	2.00	-	-	-	-	-	-	-	

1) Values according to PTB "ispark" program

2) Values according to ABNT NBR IEC 60079-25, Annex C

**Ex ec**

Basic specification, Position 1, 2 (Approval) = MG

Power supply and signal circuit with protection type: not intrinsically safe.

Basic specification, Position 3 (Power Supply, Output) = A

Terminal 1 (+), 2 (-)
Power supply: $U_N = 35 \text{ V}_{\text{DC}}$ $U_m = 250 \text{ V}$ $I_N = 4 \text{ to } 20 \text{ mA}$ $I_{\text{max}} = 22 \text{ mA}$ $P_N = 0.7 \text{ W}$

Basic specification, Position 3 (Power Supply, Output) = B

The power consumption of I/O modules with passive PFS output can be limited for certain applications.

- Recommended: Power consumption = 1 W. This is obtained for a supply voltage at the terminals of  $27 \text{ V}_{\text{DC}}$ .
- For higher supply voltages ( $U_{\text{max}}$ ): Insert a serial resistance ( $R_V$ ) in order to limit the power consumption, see table below.

**Table for the PFS serial resistance ( $R_V$ ):**

Power consumption	1.0 W
Total power consumption	1.88 W
Internal resistance $R_i$	760 $\Omega$

$U_{\text{max}}$ [V]	$R_V$ min
35	205 $\Omega$
34	177 $\Omega$
33	150 $\Omega$
32	122 $\Omega$
31	95 $\Omega$
30	67 $\Omega$
29	39 $\Omega$
28	12 $\Omega$
27	0 $\Omega$

 For values associated with a higher or lower internal power consumption please contact Endress+Hauser.

Terminal 1 (+), 2 (-)	Terminal 3 (+), 4 (-)
Power supply: $U_N = 35 \text{ V}_{\text{DC}}$ $U_m = 250 \text{ V}$ $I_N = 4 \text{ to } 20 \text{ mA}$ $I_{\text{max}} = 22 \text{ mA}$ $P_N = 0.7 \text{ W}$	Switch output (PFS): $U_N = 35 \text{ V}_{\text{DC}}$ $U_m = 250 \text{ V}$ $P_N = 0.7 \text{ W}$

Basic specification, Position 3 (Power Supply, Output) = C

Terminal 1 (+), 2 (-)	Terminal 3 (+), 4 (-)
Power supply: $U_N = 30 V_{DC}$ $U_m = 250 V$ $I_N = 4 \text{ to } 20 \text{ mA}$ $I_{max} = 22 \text{ mA}$ $P_N = 0.7 W$	Output 4 to 20 mA: $U_N = 30 V_{DC}$ $U_m = 250 V$ $I_N = 4 \text{ to } 20 \text{ mA}$ $I_{max} = 22 \text{ mA}$ $P_N = 0.7 W$

### Service interface (CDI)

In connection with: *Basic specification, Position 4 (Display, Operation) = A, C, E*

Taking the following values into consideration, the device can be connected to the Endress+Hauser FXA291 service tool or a similar interface:

Service interface
$U_N = 6.5 V$

In connection with: *Basic specification, Position 4 (Display, Operation) = L, M, N*

Taking the following values into consideration, the device can be connected to the certified Endress+Hauser FXA291 service tool or a similar interface:

Service interface														
$U_i = 7.3 V$														
effective inner inductance $L_i = \text{negligible}$														
effective inner capacitance $C_i = \text{negligible}$														
$U_o = 7.3 V$														
$I_o = 60 \text{ mA}$														
$P_o = 110 \text{ mW}$														
$L_o \text{ (mH)} =$	5.00	2.00	1.00	0.50	0.20	0.15	0.10	0.05	0.02	0.01	0.005	0.002	0.001	
$C_o \text{ (}\mu\text{F)}^{1) =}$	0.73	1.20	1.60	2.00	2.60	-	3.20	4.00	5.50	7.30	10.00	12.70	12.70	
$C_o \text{ (}\mu\text{F)}^{2) =}$	-	0.49	0.90	1.40	-	2.00	-	-	-	-	-	-	-	

1) Values according to PTB "ispark" program

2) Values according to IEC/EN 60079-25, Annex C

# Micropilot FMR60, FMR62, FMR67

4-20 mA HART

## Table of contents

Notes on the structure .....	16
Example diagrams of possible deratings .....	18
Ex ic: Zone 2 .....	19
Ex ec: Zone 2 .....	29

## Notes on the structure

## Extract from the extended order code

## Device type

FMR60, FMR62, FMR67

## Basic specifications

Position 1, 2 (Approval)		
Selected option		Description
FMR6x	MG <sup>1) 2)</sup>	INMETRO Ex ec IIC T6...T1 Gc
	MH <sup>3)</sup>	INMETRO Ex ic IIC T6...T1 Gc

- 1) Combination with Position 4 (Display, Operation) = L, M, N in connection with Position 3 (Power Supply, Output) = A is not allowed.
- 2) The designation changes in connection with Position 4 (Display, Operation) = L, M, N and Position 3 (Power Supply, Output) = B, C: Ex ec [ia Ga] IIC T6...T1 Gc. Special version only with Ex e certified entry.
- 3) The designation changes in connection with Position 4 (Display, Operation) = L, M, N and Position 3 (Power Supply, Output) = B, C: Ex ic [ia Ga] IIC T6...T1 Gc

Position 5 (Housing)		
Selected option		Description
FMR6x	A <sup>1)</sup>	GT19 dual compartment, plastic PBT
	C	GT20 dual compartment, Alu, coated
FMR62 FMR67	B	GT18 dual compartment, 316L

- 1) Only in connection with Position 1, 2 (Approval) = MH

Position 7, 8 (Antenna)		
Selected option		Description
FMR60	GA	Drip-off, PTFE DN50
FMR62	GE	Integrated, PEEK, 3/4"
	GF	Integrated, PEEK, 1-1/2"
	GM	PTFE cladded flush mount DN50
	GN	PTFE cladded flush mount DN80
FMR67	GA	Drip-off, PTFE DN50
	GP	PTFE flush mount DN80

 Shown in the temperature tables exemplary as follows:

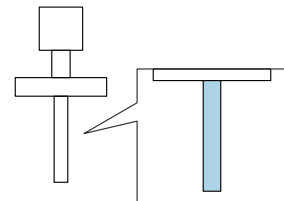



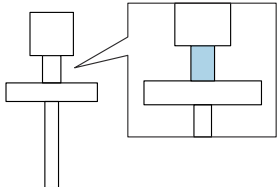

Position 9, 10 (Seal)		
Selected option		Description
FMR60	A3	FKM Viton GLT, -40...80°C/-40...176°F
	A4	FKM Viton GLT, -40...130°C/-40...266°F
	C1	FFKM Kalrez, -20...150°C/-4...302°F
	B4	EPDM, -40...150°C/-40...302°F
FMR62	A5	FKM Viton GLT, -40...150°C/-40...302°F
	A6	FKM Viton GLT, -40...200°C/-40...392°F
	C1	FFKM Kalrez, -20...150°C/-4...302°F
	C2	FFKM Kalrez, -20...200°C/-4...392°F
	F5	PTFE cladde, -40...150°C/-40...302°F
	F6	PTFE cladde, -40...200°C/-40...392°F
FMR67	A3	FKM Viton GLT, -40...80°C/-40...176°F
	A5	FKM Viton GLT, -40...150°C/-40...302°F
	A6	FKM Viton GLT, -40...200°C/-40...392°F

 Shown in the temperature tables exemplary as follows:



### General notes

-  *Optional specification, ID Nx, Ox (Accessory Mounted) = NA (Overvoltage protection Type OVP10 and Type OVP20)*  
When using the internal overvoltage protection: Reduce the admissible ambient temperature at the housing by 2 K.  
*Basic specification, Position 5 (Housing) = A*  
When using the remote display FHX50: Reduce the admissible ambient temperature at the housing by 3 K.
-  Observe the permitted temperature range at the antenna.

### Description notes

-  Unless otherwise indicated, the positions always refer to the basic specification.

1st column: Position 5 (Housing) = A, B, ...

2nd column: Temperature classes T6 (85 °C) to T1 (450 °C)

Column P1 to P5: Position (temperature value) on the axes of the derating

- $T_a$ : Ambient temperature in °C
- $T_p$ : Process temperature in °C

-  Column P2+ is only relevant for version B of the derating.

→  18

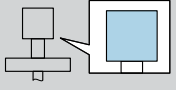
 = C		P1		P2		P2+		P3		P4		P5	
		T <sub>p</sub>	T <sub>a</sub>	T <sub>p</sub>	T <sub>a</sub>	T <sub>p</sub>	T <sub>a</sub>	T <sub>p</sub>	T <sub>a</sub>	T <sub>p</sub>	T <sub>a</sub>	T <sub>p</sub>	T <sub>a</sub>
	T6	-40	51	51	51	-	-	85	45	85	-40	-40	-40
	T5	-40	64	64	64	-	-	100	58	100	-40	-40	-40
	T4	-40	64	64	64	-	-	135	52	135	-40	-40	-40

A0031752-EN

Example diagrams of possible deratings

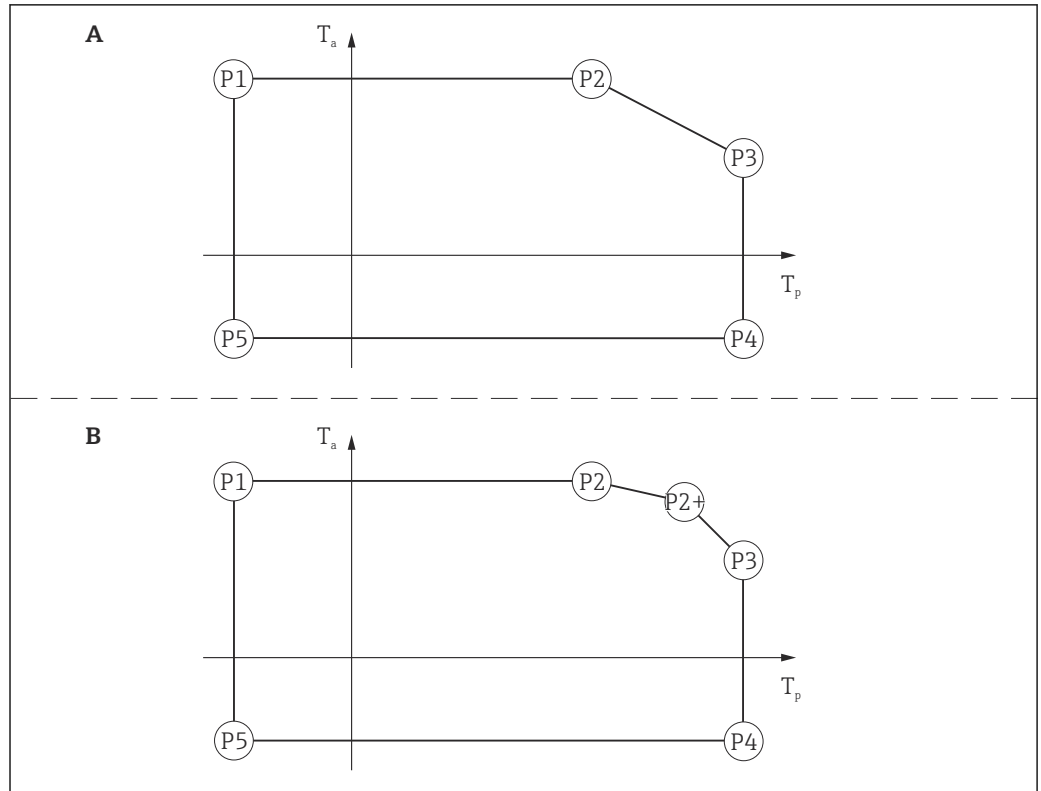

A0031943

3

**Ex ic: Zone 2**

Page references to the temperature tables of the respective device types: See the following list.

- FMR60 → 19
- FMR62 → 22
- FMR67 → 26

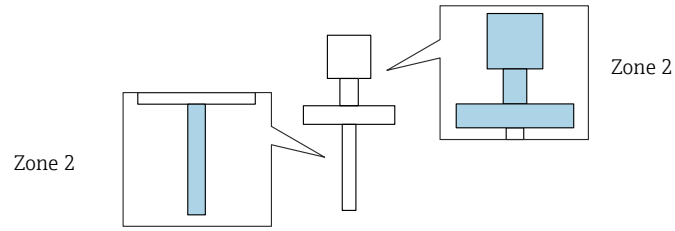

**FMR60**

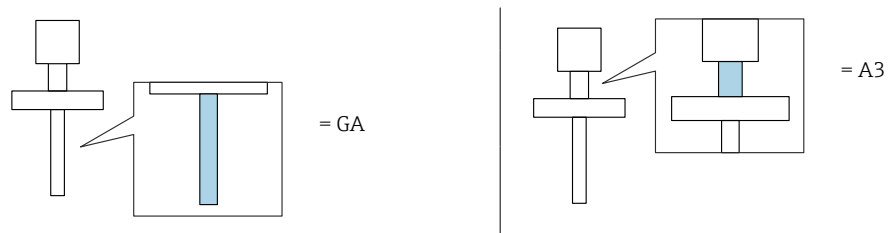

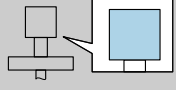
 = A	T6	P1		P2		P2+		P3		P4		P5	
		T <sub>p</sub>	T <sub>a</sub>	T <sub>p</sub>	T <sub>a</sub>	T <sub>p</sub>	T <sub>a</sub>	T <sub>p</sub>	T <sub>a</sub>	T <sub>p</sub>	T <sub>a</sub>	T <sub>p</sub>	T <sub>a</sub>
		-40	43	43	43	-	-	80	32	80	-40	-40	-40

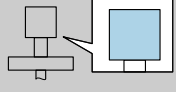
 = C	T6	P1		P2		P2+		P3		P4		P5	
		T <sub>p</sub>	T <sub>a</sub>	T <sub>p</sub>	T <sub>a</sub>	T <sub>p</sub>	T <sub>a</sub>	T <sub>p</sub>	T <sub>a</sub>	T <sub>p</sub>	T <sub>a</sub>	T <sub>p</sub>	T <sub>a</sub>
		-40	51	51	51	-	-	80	47	80	-40	-40	-40

**FMR60**

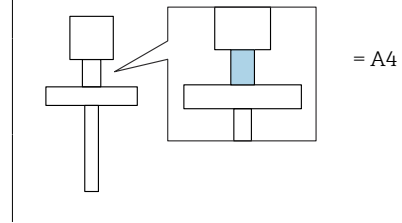
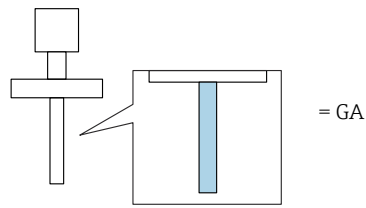

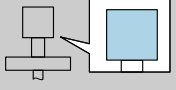
 = A		P1		P2		P2+		P3		P4		P5	
		T <sub>p</sub>	T <sub>a</sub>	T <sub>p</sub>	T <sub>a</sub>	T <sub>p</sub>	T <sub>a</sub>	T <sub>p</sub>	T <sub>a</sub>	T <sub>p</sub>	T <sub>a</sub>	T <sub>p</sub>	T <sub>a</sub>
	T6	-40	43	43	43	79	33	85	25	85	-40	-40	-40
	T5	-40	56	56	56	96	45	100	40	100	-40	-40	-40
	T4	-40	56	56	56	117	39	130	22	130	-40	-40	-40

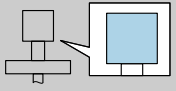
 = C		P1		P2		P2+		P3		P4		P5	
		T <sub>p</sub>	T <sub>a</sub>	T <sub>p</sub>	T <sub>a</sub>	T <sub>p</sub>	T <sub>a</sub>	T <sub>p</sub>	T <sub>a</sub>	T <sub>p</sub>	T <sub>a</sub>	T <sub>p</sub>	T <sub>a</sub>
	T6	-40	51	51	51	-	-	85	46	85	-40	-40	-40
	T5	-40	64	64	64	-	-	100	59	100	-40	-40	-40
	T4	-40	64	64	64	-	-	130	54	130	-40	-40	-40

**FMR60**

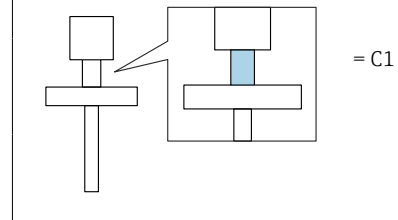
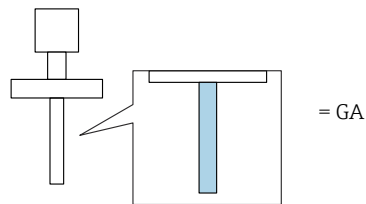

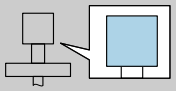
 = A		P1		P2		P2+		P3		P4		P5	
		T <sub>p</sub>	T <sub>a</sub>	T <sub>p</sub>	T <sub>a</sub>	T <sub>p</sub>	T <sub>a</sub>	T <sub>p</sub>	T <sub>a</sub>	T <sub>p</sub>	T <sub>a</sub>	T <sub>p</sub>	T <sub>a</sub>
	T6	-20	43	43	43	79	33	85	25	85	-20	-20	-20
	T5	-20	56	56	56	96	45	100	40	100	-20	-20	-20
	T4	-20	56	56	56	117	39	135	15	135	-20	-20	-20

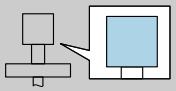
 = C		P1		P2		P2+		P3		P4		P5	
		T <sub>p</sub>	T <sub>a</sub>	T <sub>p</sub>	T <sub>a</sub>	T <sub>p</sub>	T <sub>a</sub>	T <sub>p</sub>	T <sub>a</sub>	T <sub>p</sub>	T <sub>a</sub>	T <sub>p</sub>	T <sub>a</sub>
	T6	-20	51	51	51	-	-	85	46	85	-20	-20	-20
	T5	-20	64	64	64	-	-	100	59	100	-20	-20	-20
	T4	-20	64	64	64	-	-	135	54	135	-20	-20	-20
	T3	-20	64	64	64	-	-	150	50	150	-20	-20	-20

**FMR60**

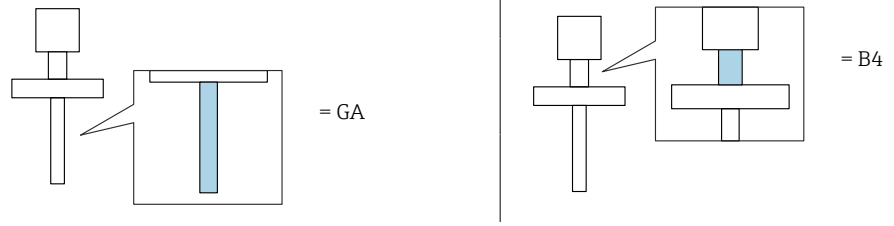

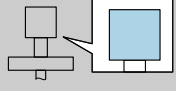
 = A		P1		P2		P2+		P3		P4		P5	
		T <sub>p</sub>	T <sub>a</sub>	T <sub>p</sub>	T <sub>a</sub>	T <sub>p</sub>	T <sub>a</sub>	T <sub>p</sub>	T <sub>a</sub>	T <sub>p</sub>	T <sub>a</sub>	T <sub>p</sub>	T <sub>a</sub>
	T6	-40	43	43	43	79	33	85	25	85	-40	-40	-40
	T5	-40	56	56	56	96	45	100	40	100	-40	-40	-40
	T4	-40	56	56	56	117	39	135	15	135	-40	-40	-40

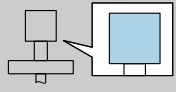
 = C		P1		P2		P2+		P3		P4		P5	
		T <sub>p</sub>	T <sub>a</sub>	T <sub>p</sub>	T <sub>a</sub>	T <sub>p</sub>	T <sub>a</sub>	T <sub>p</sub>	T <sub>a</sub>	T <sub>p</sub>	T <sub>a</sub>	T <sub>p</sub>	T <sub>a</sub>
	T6	-40	51	51	51	-	-	85	46	85	-40	-40	-40
	T5	-40	64	64	64	-	-	100	59	100	-40	-40	-40
	T4	-40	64	64	64	-	-	135	54	135	-40	-40	-40
	T3	-40	64	64	64	-	-	150	50	150	-40	-40	-40

FMR62

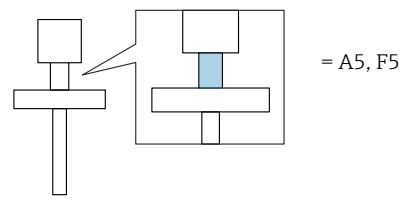
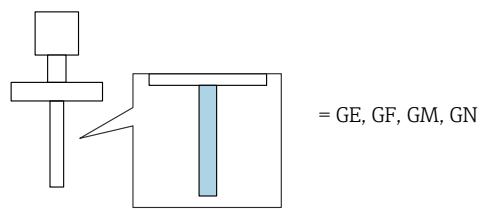

= A		P1		P2		P2+		P3		P4		P5	
		T <sub>p</sub>	T <sub>a</sub>	T <sub>p</sub>	T <sub>a</sub>	T <sub>p</sub>	T <sub>a</sub>	T <sub>p</sub>	T <sub>a</sub>	T <sub>p</sub>	T <sub>a</sub>	T <sub>p</sub>	T <sub>a</sub>
	T6	-40	43	43	43	-	-	85	34	85	-40	-40	-40
	T5	-40	56	56	56	-	-	100	46	100	-40	-40	-40
	T4	-40	56	56	56	-	-	135	38	135	-40	-40	-40
	T3	-40	56	56	56	134	39	150	24	150	-40	-40	-40

= B		P1		P2		P2+		P3		P4		P5	
		T <sub>p</sub>	T <sub>a</sub>	T <sub>p</sub>	T <sub>a</sub>	T <sub>p</sub>	T <sub>a</sub>	T <sub>p</sub>	T <sub>a</sub>	T <sub>p</sub>	T <sub>a</sub>	T <sub>p</sub>	T <sub>a</sub>
	T6	-40	51	51	51	-	-	85	45	85	-40	-40	-40
	T5	-40	64	64	64	-	-	100	58	100	-40	-40	-40
	T4	-40	64	64	64	-	-	135	52	135	-40	-40	-40
	T3	-40	64	64	64	-	-	150	47	150	-40	-40	-40

= C		P1		P2		P2+		P3		P4		P5	
		T <sub>p</sub>	T <sub>a</sub>	T <sub>p</sub>	T <sub>a</sub>	T <sub>p</sub>	T <sub>a</sub>	T <sub>p</sub>	T <sub>a</sub>	T <sub>p</sub>	T <sub>a</sub>	T <sub>p</sub>	T <sub>a</sub>
	T6	-40	51	51	51	-	-	85	47	85	-40	-40	-40
	T5	-40	64	64	64	-	-	100	60	100	-40	-40	-40
	T4	-40	64	64	64	-	-	135	56	135	-40	-40	-40
	T3	-40	64	64	64	-	-	150	54	150	-40	-40	-40

**FMR62**

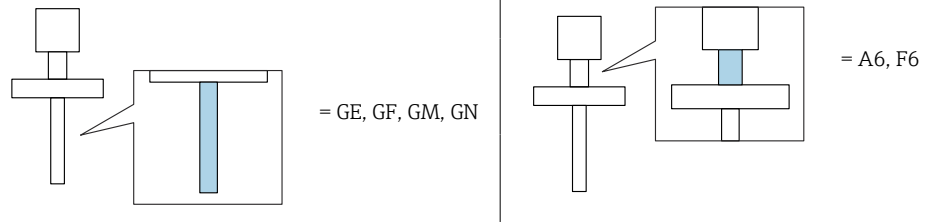

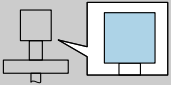
 = A		P1		P2		P2+		P3		P4		P5	
		T <sub>p</sub>	T <sub>a</sub>	T <sub>p</sub>	T <sub>a</sub>	T <sub>p</sub>	T <sub>a</sub>	T <sub>p</sub>	T <sub>a</sub>	T <sub>p</sub>	T <sub>a</sub>	T <sub>p</sub>	T <sub>a</sub>
	T6	-40	43	43	43	-	-	85	38	85	-40	-40	-40
	T5	-40	56	56	56	-	-	100	51	100	-40	-40	-40
	T4	-40	56	56	56	-	-	135	47	135	-40	-40	-40
	T3	-40	56	56	56	-	-	200	40	200	-40	-40	-40

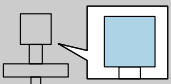
 = B, C		P1		P2		P2+		P3		P4		P5	
		T <sub>p</sub>	T <sub>a</sub>	T <sub>p</sub>	T <sub>a</sub>	T <sub>p</sub>	T <sub>a</sub>	T <sub>p</sub>	T <sub>a</sub>	T <sub>p</sub>	T <sub>a</sub>	T <sub>p</sub>	T <sub>a</sub>
	T6	-40	51	51	51	-	-	85	48	85	-40	-40	-40
	T5	-40	64	64	64	-	-	100	61	100	-40	-40	-40
	T4	-40	64	64	64	-	-	135	58	135	-40	-40	-40
	T3	-40	64	64	64	-	-	200	53	200	-40	-40	-40

**FMR62**

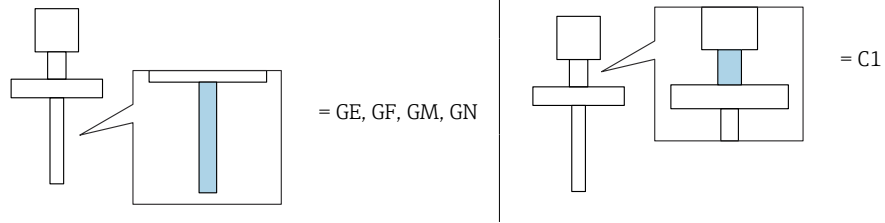

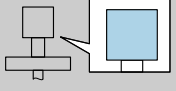
 = A		P1		P2		P2+		P3		P4		P5	
		T <sub>p</sub>	T <sub>a</sub>	T <sub>p</sub>	T <sub>a</sub>	T <sub>p</sub>	T <sub>a</sub>	T <sub>p</sub>	T <sub>a</sub>	T <sub>p</sub>	T <sub>a</sub>	T <sub>p</sub>	T <sub>a</sub>
	T6	-20	43	43	43	-	-	85	34	85	-20	-20	-20
	T5	-20	56	56	56	-	-	100	46	100	-20	-20	-20
	T4	-20	56	56	56	-	-	135	38	135	-20	-20	-20
	T3	-20	56	56	56	134	39	150	24	150	-20	-20	-20

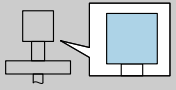
 = B		P1		P2		P2+		P3		P4		P5	
		T <sub>p</sub>	T <sub>a</sub>	T <sub>p</sub>	T <sub>a</sub>	T <sub>p</sub>	T <sub>a</sub>	T <sub>p</sub>	T <sub>a</sub>	T <sub>p</sub>	T <sub>a</sub>	T <sub>p</sub>	T <sub>a</sub>
	T6	-20	51	51	51	-	-	85	45	85	-20	-20	-20
	T5	-20	64	64	64	-	-	100	58	100	-20	-20	-20
	T4	-20	64	64	64	-	-	135	52	135	-20	-20	-20
	T3	-20	64	64	64	-	-	150	47	150	-20	-20	-20

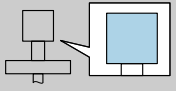
 = C		P1		P2		P2+		P3		P4		P5	
		T <sub>p</sub>	T <sub>a</sub>	T <sub>p</sub>	T <sub>a</sub>	T <sub>p</sub>	T <sub>a</sub>	T <sub>p</sub>	T <sub>a</sub>	T <sub>p</sub>	T <sub>a</sub>	T <sub>p</sub>	T <sub>a</sub>
	T6	-20	51	51	51	-	-	85	47	85	-20	-20	-20
	T5	-20	64	64	64	-	-	100	60	100	-20	-20	-20
	T4	-20	64	64	64	-	-	135	56	135	-20	-20	-20
	T3	-20	64	64	64	-	-	150	54	150	-20	-20	-20



**FMR62**

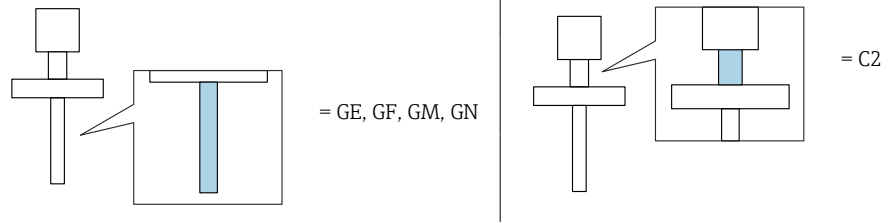

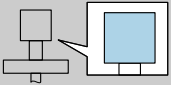
 = A		P1		P2		P2+		P3		P4		P5	
		T <sub>p</sub>	T <sub>a</sub>	T <sub>p</sub>	T <sub>a</sub>	T <sub>p</sub>	T <sub>a</sub>	T <sub>p</sub>	T <sub>a</sub>	T <sub>p</sub>	T <sub>a</sub>	T <sub>p</sub>	T <sub>a</sub>
	T6	-20	43	43	43	-	-	85	38	85	-20	-20	-20
	T5	-20	56	56	56	-	-	100	51	100	-20	-20	-20
	T4	-20	56	56	56	-	-	135	47	135	-20	-20	-20
	T3	-20	56	56	56	-	-	200	40	200	-20	-20	-20

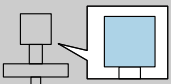
 = B, C		P1		P2		P2+		P3		P4		P5	
		T <sub>p</sub>	T <sub>a</sub>	T <sub>p</sub>	T <sub>a</sub>	T <sub>p</sub>	T <sub>a</sub>	T <sub>p</sub>	T <sub>a</sub>	T <sub>p</sub>	T <sub>a</sub>	T <sub>p</sub>	T <sub>a</sub>
	T6	-20	51	51	51	-	-	85	48	85	-20	-20	-20
	T5	-20	64	64	64	-	-	100	61	100	-20	-20	-20
	T4	-20	64	64	64	-	-	135	58	135	-20	-20	-20
	T3	-20	64	64	64	-	-	200	53	200	-20	-20	-20

FMR67

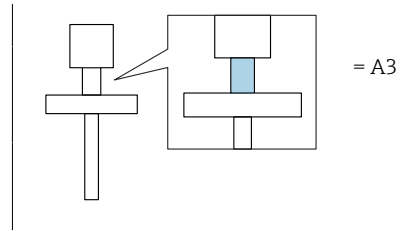
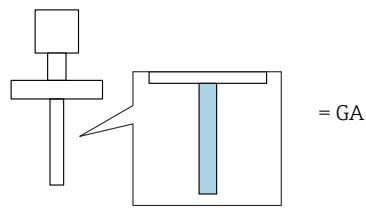

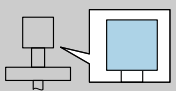
 = A		P1		P2		P2+		P3		P4		P5	
		T <sub>p</sub>	T <sub>a</sub>	T <sub>p</sub>	T <sub>a</sub>	T <sub>p</sub>	T <sub>a</sub>	T <sub>p</sub>	T <sub>a</sub>	T <sub>p</sub>	T <sub>a</sub>	T <sub>p</sub>	T <sub>a</sub>
	T6	-40	43	43	43	-	-	80	32	80	-40	-40	-40

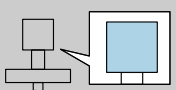
 = B		P1		P2		P2+		P3		P4		P5	
		T <sub>p</sub>	T <sub>a</sub>	T <sub>p</sub>	T <sub>a</sub>	T <sub>p</sub>	T <sub>a</sub>	T <sub>p</sub>	T <sub>a</sub>	T <sub>p</sub>	T <sub>a</sub>	T <sub>p</sub>	T <sub>a</sub>
	T6	-40	51	51	51	-	-	80	43	80	-40	-40	-40

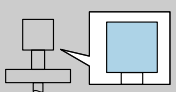
 = C		P1		P2		P2+		P3		P4		P5	
		T <sub>p</sub>	T <sub>a</sub>	T <sub>p</sub>	T <sub>a</sub>	T <sub>p</sub>	T <sub>a</sub>	T <sub>p</sub>	T <sub>a</sub>	T <sub>p</sub>	T <sub>a</sub>	T <sub>p</sub>	T <sub>a</sub>
	T6	-40	51	51	51	-	-	80	47	80	-40	-40	-40

**FMR67**

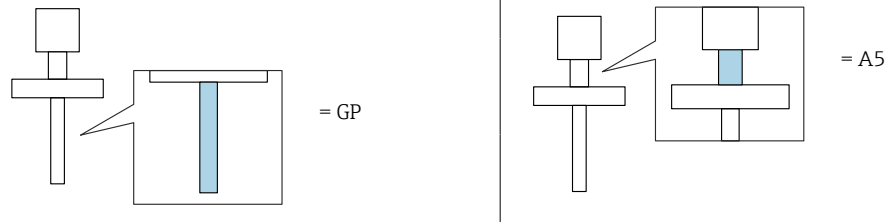

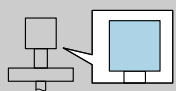
 = A		P1		P2		P2+		P3		P4		P5	
		T <sub>p</sub>	T <sub>a</sub>	T <sub>p</sub>	T <sub>a</sub>	T <sub>p</sub>	T <sub>a</sub>	T <sub>p</sub>	T <sub>a</sub>	T <sub>p</sub>	T <sub>a</sub>	T <sub>p</sub>	T <sub>a</sub>
	T6	-40	43	43	43	-	-	85	34	85	-40	-40	-40
	T5	-40	56	56	56	-	-	100	46	100	-40	-40	-40
	T4	-40	56	56	56	-	-	135	38	135	-40	-40	-40
	T3	-40	56	56	56	134	39	150	24	150	-40	-40	-40

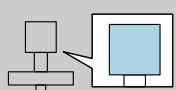
 = B		P1		P2		P2+		P3		P4		P5	
		T <sub>p</sub>	T <sub>a</sub>	T <sub>p</sub>	T <sub>a</sub>	T <sub>p</sub>	T <sub>a</sub>	T <sub>p</sub>	T <sub>a</sub>	T <sub>p</sub>	T <sub>a</sub>	T <sub>p</sub>	T <sub>a</sub>
	T6	-40	51	51	51	-	-	85	45	85	-40	-40	-40
	T5	-40	64	64	64	-	-	100	58	100	-40	-40	-40
	T4	-40	64	64	64	-	-	135	52	135	-40	-40	-40
	T3	-40	64	64	64	-	-	150	47	150	-40	-40	-40

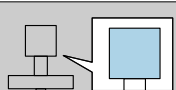
 = C		P1		P2		P2+		P3		P4		P5	
		T <sub>p</sub>	T <sub>a</sub>	T <sub>p</sub>	T <sub>a</sub>	T <sub>p</sub>	T <sub>a</sub>	T <sub>p</sub>	T <sub>a</sub>	T <sub>p</sub>	T <sub>a</sub>	T <sub>p</sub>	T <sub>a</sub>
	T6	-40	51	51	51	-	-	85	47	85	-40	-40	-40
	T5	-40	64	64	64	-	-	100	60	100	-40	-40	-40
	T4	-40	64	64	64	-	-	135	56	135	-40	-40	-40
	T3	-40	64	64	64	-	-	150	54	150	-40	-40	-40

**FMR67**

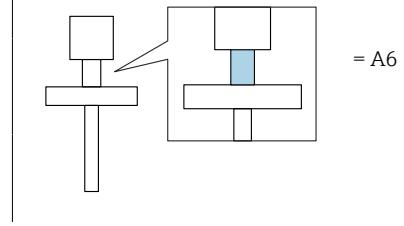
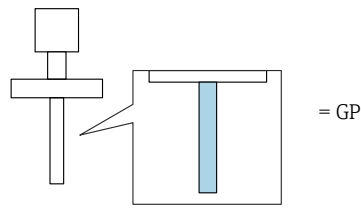

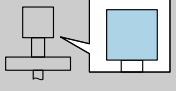
 = A		P1		P2		P2+		P3		P4		P5	
		T <sub>p</sub>	T <sub>a</sub>	T <sub>p</sub>	T <sub>a</sub>	T <sub>p</sub>	T <sub>a</sub>	T <sub>p</sub>	T <sub>a</sub>	T <sub>p</sub>	T <sub>a</sub>	T <sub>p</sub>	T <sub>a</sub>
	T6	-40	43	43	43	-	-	85	38	85	-40	-40	-40
	T5	-40	56	56	56	-	-	100	51	100	-40	-40	-40
	T4	-40	56	56	56	-	-	135	47	135	-40	-40	-40
	T3	-40	56	56	56	-	-	200	40	200	-40	-40	-40

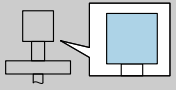
 = B, C		P1		P2		P2+		P3		P4		P5	
		T <sub>p</sub>	T <sub>a</sub>	T <sub>p</sub>	T <sub>a</sub>	T <sub>p</sub>	T <sub>a</sub>	T <sub>p</sub>	T <sub>a</sub>	T <sub>p</sub>	T <sub>a</sub>	T <sub>p</sub>	T <sub>a</sub>
	T6	-40	51	51	51	-	-	85	48	85	-40	-40	-40
	T5	-40	64	64	64	-	-	100	61	100	-40	-40	-40
	T4	-40	64	64	64	-	-	135	58	135	-40	-40	-40
	T3	-40	64	64	64	-	-	200	53	200	-40	-40	-40

**Ex ec: Zone 2**

Page references to the temperature tables of the respective device types: See the following list.

- FMR60 → 29
- FMR62 → 32
- FMR67 → 34

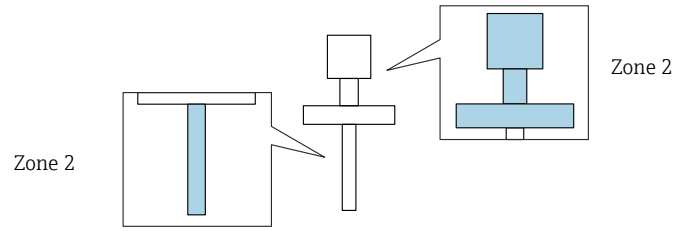

**FMR60**

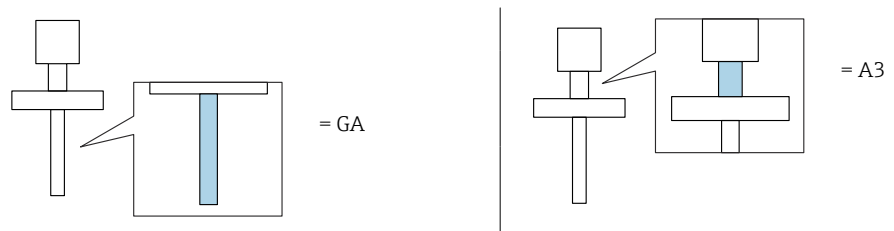

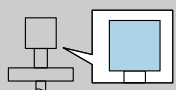
		P1		P2		P2+		P3		P4		P5	
		T <sub>p</sub>	T <sub>a</sub>	T <sub>p</sub>	T <sub>a</sub>	T <sub>p</sub>	T <sub>a</sub>	T <sub>p</sub>	T <sub>a</sub>	T <sub>p</sub>	T <sub>a</sub>	T <sub>p</sub>	T <sub>a</sub>
	T6	-40	41	41	41	-	-	80	32	80	-40	-40	-40

**FMR60**

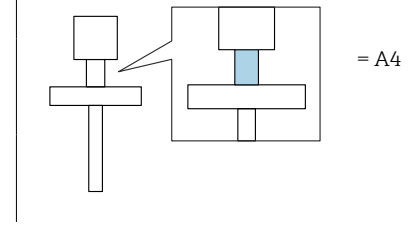
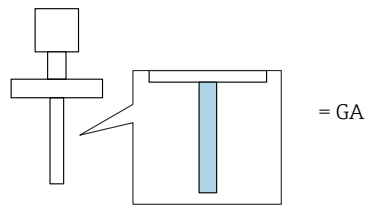

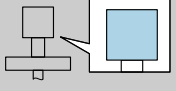
 = C		P1		P2		P2+		P3		P4		P5	
		T <sub>p</sub>	T <sub>a</sub>	T <sub>p</sub>	T <sub>a</sub>	T <sub>p</sub>	T <sub>a</sub>	T <sub>p</sub>	T <sub>a</sub>	T <sub>p</sub>	T <sub>a</sub>	T <sub>p</sub>	T <sub>a</sub>
	T6	-40	41	41	41	-	-	85	34	85	-40	-40	-40
	T5	-40	56	56	56	-	-	100	49	100	-40	-40	-40
	T4	-40	64	64	64	-	-	130	54	130	-40	-40	-40

**FMR60**

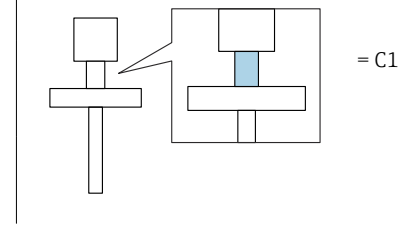
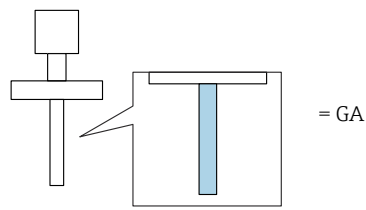

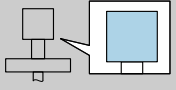
 = C		P1		P2		P2+		P3		P4		P5	
		T <sub>p</sub>	T <sub>a</sub>	T <sub>p</sub>	T <sub>a</sub>	T <sub>p</sub>	T <sub>a</sub>	T <sub>p</sub>	T <sub>a</sub>	T <sub>p</sub>	T <sub>a</sub>	T <sub>p</sub>	T <sub>a</sub>
	T6	-20	41	41	41	-	-	85	34	85	-20	-20	-20
	T5	-20	56	56	56	-	-	100	49	100	-20	-20	-20
	T4	-20	64	64	64	-	-	135	54	135	-20	-20	-20
	T3	-20	64	64	64	-	-	150	50	150	-20	-20	-20

**FMR60**

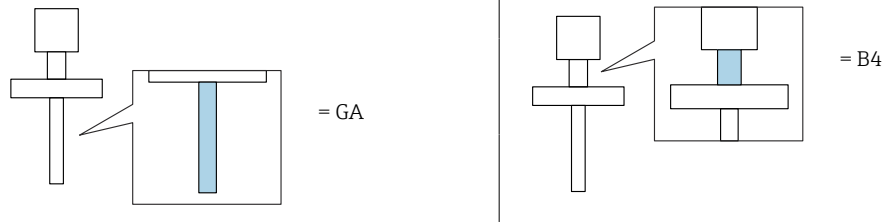

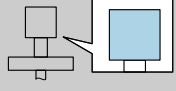
		P1		P2		P2+		P3		P4		P5	
		T <sub>p</sub>	T <sub>a</sub>	T <sub>p</sub>	T <sub>a</sub>	T <sub>p</sub>	T <sub>a</sub>	T <sub>p</sub>	T <sub>a</sub>	T <sub>p</sub>	T <sub>a</sub>	T <sub>p</sub>	T <sub>a</sub>
	T6	-40	41	41	41	-	-	85	34	85	-40	-40	-40
	T5	-40	56	56	56	-	-	100	49	100	-40	-40	-40
	T4	-40	64	64	64	-	-	135	54	135	-40	-40	-40
	T3	-40	64	64	64	-	-	150	50	150	-40	-40	-40

**FMR62**

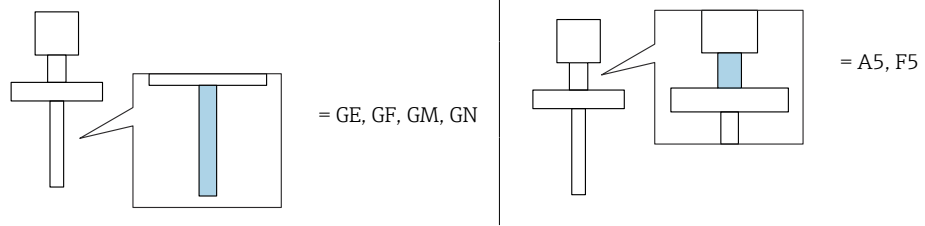

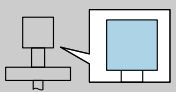
 = B		P1		P2		P2+		P3		P4		P5	
		T <sub>p</sub>	T <sub>a</sub>	T <sub>p</sub>	T <sub>a</sub>	T <sub>p</sub>	T <sub>a</sub>	T <sub>p</sub>	T <sub>a</sub>	T <sub>p</sub>	T <sub>a</sub>	T <sub>p</sub>	T <sub>a</sub>
	T6	-40	41	41	41	-	-	85	33	85	-40	-40	-40
	T5	-40	56	56	56	-	-	100	48	100	-40	-40	-40
	T4	-40	64	64	64	-	-	135	52	135	-40	-40	-40
	T3	-40	64	64	64	-	-	150	47	150	-40	-40	-40

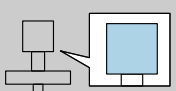
 = C		P1		P2		P2+		P3		P4		P5	
		T <sub>p</sub>	T <sub>a</sub>	T <sub>p</sub>	T <sub>a</sub>	T <sub>p</sub>	T <sub>a</sub>	T <sub>p</sub>	T <sub>a</sub>	T <sub>p</sub>	T <sub>a</sub>	T <sub>p</sub>	T <sub>a</sub>
	T6	-40	41	41	41	-	-	85	36	85	-40	-40	-40
	T5	-40	56	56	56	-	-	100	51	100	-40	-40	-40
	T4	-40	64	64	64	-	-	135	56	135	-40	-40	-40
	T3	-40	64	64	64	-	-	150	54	150	-40	-40	-40

**FMR62**

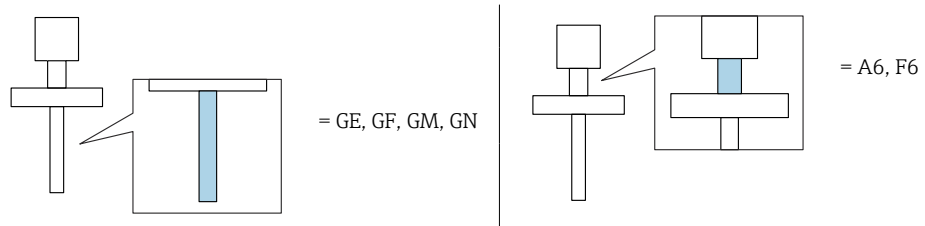

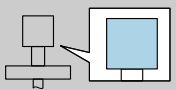
 = B, C		P1		P2		P2+		P3		P4		P5	
		T <sub>p</sub>	T <sub>a</sub>	T <sub>p</sub>	T <sub>a</sub>	T <sub>p</sub>	T <sub>a</sub>	T <sub>p</sub>	T <sub>a</sub>	T <sub>p</sub>	T <sub>a</sub>	T <sub>p</sub>	T <sub>a</sub>
	T6	-40	41	41	41	-	-	85	37	85	-40	-40	-40
	T5	-40	56	56	56	-	-	100	52	100	-40	-40	-40
	T4	-40	64	64	64	-	-	135	58	135	-40	-40	-40
	T3	-40	64	64	64	-	-	200	53	200	-40	-40	-40



**FMR62**

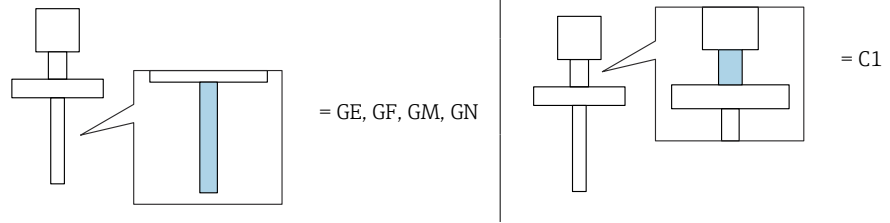

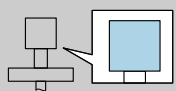
 = B		P1		P2		P2+		P3		P4		P5	
		T <sub>p</sub>	T <sub>a</sub>	T <sub>p</sub>	T <sub>a</sub>	T <sub>p</sub>	T <sub>a</sub>	T <sub>p</sub>	T <sub>a</sub>	T <sub>p</sub>	T <sub>a</sub>	T <sub>p</sub>	T <sub>a</sub>
	T6	-20	41	41	41	-	-	85	33	85	-20	-20	-20
	T5	-20	56	56	56	-	-	100	48	100	-20	-20	-20
	T4	-20	64	64	64	-	-	135	52	135	-20	-20	-20
	T3	-20	64	64	64	-	-	150	47	150	-20	-20	-20

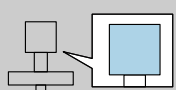
 = C		P1		P2		P2+		P3		P4		P5	
		T <sub>p</sub>	T <sub>a</sub>	T <sub>p</sub>	T <sub>a</sub>	T <sub>p</sub>	T <sub>a</sub>	T <sub>p</sub>	T <sub>a</sub>	T <sub>p</sub>	T <sub>a</sub>	T <sub>p</sub>	T <sub>a</sub>
	T6	-20	41	41	41	-	-	85	36	85	-20	-20	-20
	T5	-20	56	56	56	-	-	100	51	100	-20	-20	-20
	T4	-20	64	64	64	-	-	135	56	135	-20	-20	-20
	T3	-20	64	64	64	-	-	150	54	150	-20	-20	-20

**FMR62**

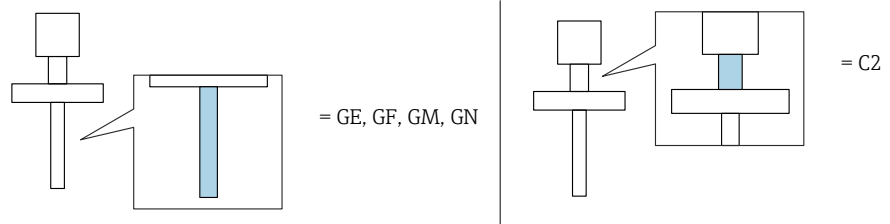

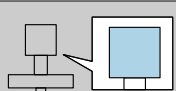
 = B, C		P1		P2		P2+		P3		P4		P5	
		T <sub>p</sub>	T <sub>a</sub>	T <sub>p</sub>	T <sub>a</sub>	T <sub>p</sub>	T <sub>a</sub>	T <sub>p</sub>	T <sub>a</sub>	T <sub>p</sub>	T <sub>a</sub>	T <sub>p</sub>	T <sub>a</sub>
	T6	-20	41	41	41	-	-	85	37	85	-20	-20	-20
	T5	-20	56	56	56	-	-	100	52	100	-20	-20	-20
	T4	-20	64	64	64	-	-	135	58	135	-20	-20	-20
	T3	-20	64	64	64	-	-	200	53	200	-20	-20	-20

**FMR67**

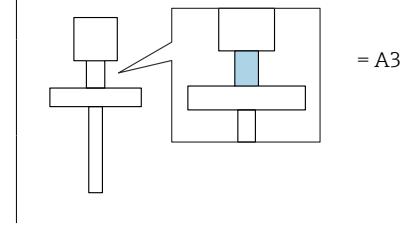
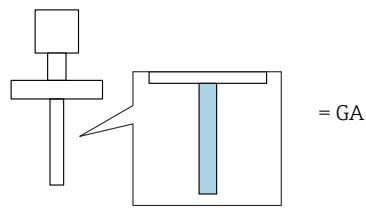

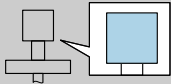
 = B, C		P1		P2		P2+		P3		P4		P5	
		T <sub>p</sub>	T <sub>a</sub>	T <sub>p</sub>	T <sub>a</sub>	T <sub>p</sub>	T <sub>a</sub>	T <sub>p</sub>	T <sub>a</sub>	T <sub>p</sub>	T <sub>a</sub>	T <sub>p</sub>	T <sub>a</sub>
	T6	-40	41	41	41	-	-	80	32	80	-40	-40	-40

**FMR67**

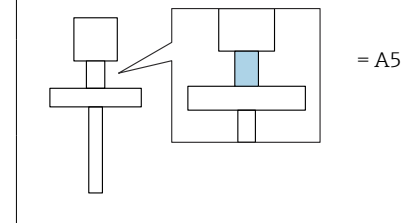
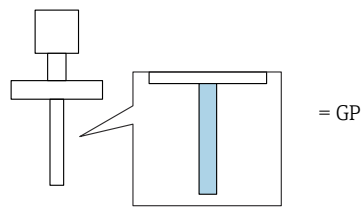

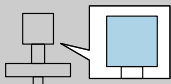
 = B		P1		P2		P2+		P3		P4		P5	
		T <sub>p</sub>	T <sub>a</sub>	T <sub>p</sub>	T <sub>a</sub>	T <sub>p</sub>	T <sub>a</sub>	T <sub>p</sub>	T <sub>a</sub>	T <sub>p</sub>	T <sub>a</sub>	T <sub>p</sub>	T <sub>a</sub>
	T6	-40	41	41	41	-	-	85	33	85	-40	-40	-40
	T5	-40	56	56	56	-	-	100	48	100	-40	-40	-40
	T4	-40	64	64	64	-	-	135	52	135	-40	-40	-40
	T3	-40	64	64	64	-	-	150	47	150	-40	-40	-40

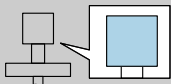
 = C		P1		P2		P2+		P3		P4		P5	
		T <sub>p</sub>	T <sub>a</sub>	T <sub>p</sub>	T <sub>a</sub>	T <sub>p</sub>	T <sub>a</sub>	T <sub>p</sub>	T <sub>a</sub>	T <sub>p</sub>	T <sub>a</sub>	T <sub>p</sub>	T <sub>a</sub>
	T6	-40	41	41	41	-	-	85	36	85	-40	-40	-40
	T5	-40	56	56	56	-	-	100	51	100	-40	-40	-40
	T4	-40	64	64	64	-	-	135	56	135	-40	-40	-40
	T3	-40	64	64	64	-	-	150	54	150	-40	-40	-40

**FMR67**

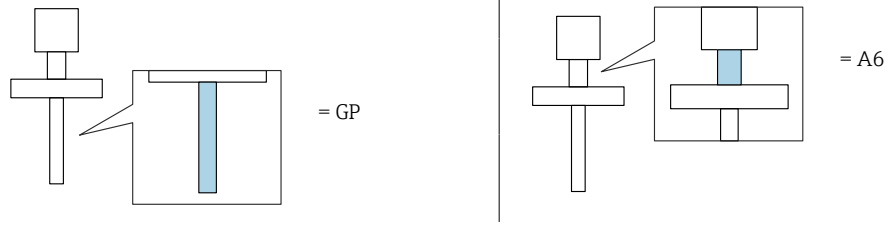

		P1		P2		P2+		P3		P4		P5	
		T <sub>p</sub>	T <sub>a</sub>	T <sub>p</sub>	T <sub>a</sub>	T <sub>p</sub>	T <sub>a</sub>	T <sub>p</sub>	T <sub>a</sub>	T <sub>p</sub>	T <sub>a</sub>	T <sub>p</sub>	T <sub>a</sub>
	T6	-40	41	41	41	-	-	85	37	85	-40	-40	-40
	T5	-40	56	56	56	-	-	100	52	100	-40	-40	-40
	T4	-40	64	64	64	-	-	135	58	135	-40	-40	-40
	T3	-40	64	64	64	-	-	200	53	200	-40	-40	-40



71493466

[www.addresses.endress.com](http://www.addresses.endress.com)

---