

Operating Instructions

CTS1

Temperature sensor e. g. for automatic
temperature compensation during pH
measurement

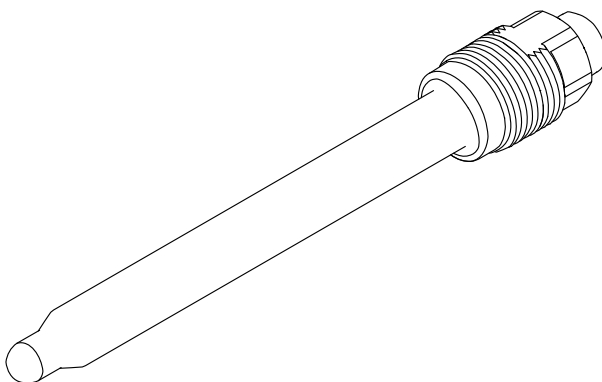





Table of contents







1	About this document	4
1.1	Warnings	4
1.2	Symbols used	4
2	Basic safety instructions	6
2.1	Requirements for personnel	6
2.2	Designated use	6
2.3	Workplace safety	6
2.4	Operational safety	6
2.5	Product safety	7
3	Incoming acceptance and product identification	8
3.1	Incoming acceptance	8
3.2	Product identification	8
3.3	Scope of delivery	9
3.4	Certificates and approvals	9
4	Installation	10
4.1	Installation conditions	10
5	Electrical connection	11
5.1	Connecting the sensor	11
6	Repair	12
6.1	Return	12
6.2	Disposal	12
7	Accessories	13
8	Technical data	14
8.1	Input	14
8.2	Process	14
8.3	Mechanical construction	14

1 About this document

1.1 Warnings

Structure of information	Meaning
 <p>Causes (/consequences) If necessary, Consequences of non-compliance (if applicable)</p> <ul style="list-style-type: none"> ▶ Corrective action 	<p>This symbol alerts you to a dangerous situation. Failure to avoid the dangerous situation will result in a fatal or serious injury.</p>
 <p>Causes (/consequences) If necessary, Consequences of non-compliance (if applicable)</p> <ul style="list-style-type: none"> ▶ Corrective action 	<p>This symbol alerts you to a dangerous situation. Failure to avoid the dangerous situation can result in a fatal or serious injury.</p>
 <p>Causes (/consequences) If necessary, Consequences of non-compliance (if applicable)</p> <ul style="list-style-type: none"> ▶ Corrective action 	<p>This symbol alerts you to a dangerous situation. Failure to avoid this situation can result in minor or more serious injuries.</p>
 <p>Cause/situation If necessary, Consequences of non-compliance (if applicable)</p> <ul style="list-style-type: none"> ▶ Action/note 	<p>This symbol alerts you to situations which may result in damage to property.</p>

1.2 Symbols used

Symbol	Meaning
	Additional information, tips
	Permitted or recommended
	Not permitted or not recommended
	Reference to device documentation
	Reference to page
	Reference to graphic
	Result of a step

1.2.1 Symbols on the device

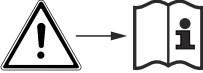
Symbol	Meaning
	Reference to device documentation

2 Basic safety instructions

2.1 Requirements for personnel

- Installation, commissioning, operation and maintenance of the measuring system may be carried out only by specially trained technical personnel.
- The technical personnel must be authorized by the plant operator to carry out the specified activities.
- The electrical connection may be performed only by an electrical technician.
- The technical personnel must have read and understood these Operating Instructions and must follow the instructions contained therein.
- Faults at the measuring point may only be rectified by authorized and specially trained personnel.



Repairs not described in the Operating Instructions provided must be carried out only directly at the manufacturer's site or by the service organization.

2.2 Designated use

The sensor is used for temperature measurement. It can be combined with pH sensors.

Use of the device for any purpose other than that described, poses a threat to the safety of people and of the entire measuring system and is therefore not permitted.

The manufacturer is not liable for damage caused by improper or non-designated use.

2.3 Workplace safety

As the user, you are responsible for complying with the following safety conditions:

- Installation guidelines
- Local standards and regulations
- Regulations for explosion protection

2.4 Operational safety

Before commissioning the entire measuring point:

1. Verify that all connections are correct.
2. Ensure that electrical cables and hose connections are undamaged.
3. Do not operate damaged products, and protect them against unintentional operation.
4. Label damaged products as defective.

During operation:

- ▶ If faults cannot be rectified:
products must be taken out of service and protected against unintentional operation.

2.5 Product safety

2.5.1 State-of-the-art technology

The product is designed to meet state-of-the-art safety requirements, has been tested, and left the factory in a condition in which it is safe to operate. The relevant regulations and international standards have been observed.

3 Incoming acceptance and product identification

3.1 Incoming acceptance

1. Verify that the packaging is undamaged.
 - ↳ Notify the supplier of any damage to the packaging.
Keep the damaged packaging until the issue has been resolved.
2. Verify that the contents are undamaged.
 - ↳ Notify the supplier of any damage to the delivery contents.
Keep the damaged goods until the issue has been resolved.
3. Check that the delivery is complete and nothing is missing.
 - ↳ Compare the shipping documents with your order.
4. Pack the product for storage and transportation in such a way that it is protected against impact and moisture.
 - ↳ The original packaging offers the best protection.
Make sure to comply with the permitted ambient conditions.

If you have any questions, please contact your supplier or your local Sales Center.

3.2 Product identification

3.2.1 Nameplate

The nameplate provides you with the following information on your device:

- Manufacturer details
 - Order code
 - Serial number
 - Operating conditions
 - Safety information and warnings
- Compare the information on the nameplate with the order.

3.2.2 Product identification

Product page

www.endress.com/cts1

Interpreting the order code

The order code and serial number of your product can be found in the following locations:

- On the nameplate
- In the delivery papers

Obtaining information on the product

1. Go to www.endress.com.
2. Call up the site search (magnifying glass).
3. Enter a valid serial number.

4. Search.

- ↳ The product structure is displayed in a popup window.

5. Click on the product image in the popup window.

- ↳ A new window (**Device Viewer**) opens. All of the information relating to your device is displayed in this window as well as the product documentation.

3.2.3 Manufacturer's address

Endress+Hauser Conducta GmbH+Co. KG
Dieselstraße 24
D-70839 Gerlingen

3.3 Scope of delivery

The scope of delivery comprises:

- Sensor in the version ordered
- Operating Instructions

3.4 Certificates and approvals

3.4.1 CE mark

The product meets the requirements of the harmonized European standards. As such, it complies with the legal specifications of the EU directives. The manufacturer confirms successful testing of the product by affixing to it the **CE** mark.

3.4.2 Ex approval

- ATEX II 1G EEx ia IIC T3/T4/T6
- FM Class I Div. 2, in conjunction with the Mypro CPM431 and Liquiline M CM42 transmitter

3.4.3 Additional certification

TÜV certificate for TOP68 plug-in head

Pressure resistance 16 bar rel. (232 psi), minimum three times the safety pressure

4 Installation

4.1 Installation conditions

4.1.1 Dimensions

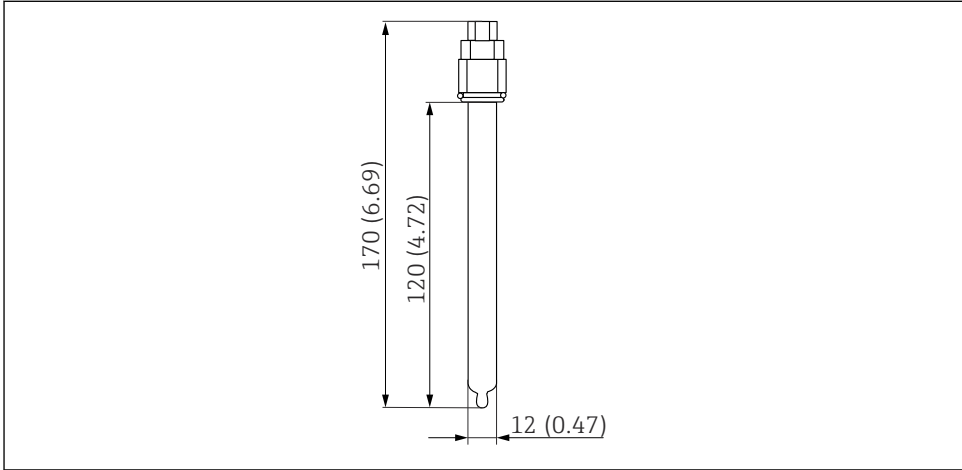

A0043222

1 Dimensions. Engineering unit: mm (in)

5 Electrical connection

5.1 Connecting the sensor

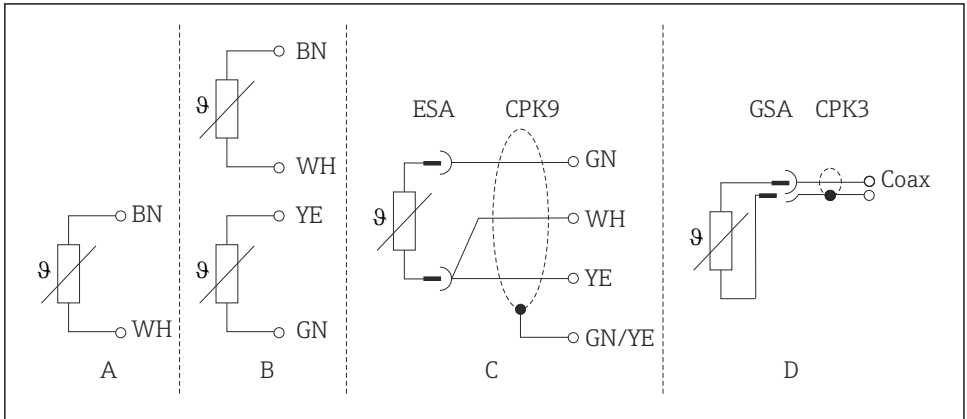

A0043164

2 Cable connection

- A Fixed cable (version with GFB terminal head) and type A (single Pt100)
- B Fixed cable (version with GFB terminal head) and type B (double Pt100)
- C Connection of version with ESA threaded plug-in head with CPK9 cable
- D Connection of version with GSA threaded plug-in head with CPK3 cable

6 Repair

6.1 Return

The product must be returned if repairs or a factory calibration are required, or if the wrong product was ordered or delivered. As an ISO-certified company and also due to legal regulations, Endress+Hauser is obliged to follow certain procedures when handling any returned products that have been in contact with medium.

To ensure the swift, safe and professional return of the device:

- ▶ Refer to the website www.endress.com/support/return-material for information on the procedure and conditions for returning devices.

6.2 Disposal

The device contains electronic components. The product must be disposed of as electronic waste.

- ▶ Observe the local regulations.

7 Accessories

Measuring cable CPK3

- Preassembled measuring cable for connecting analog sensors with GSA plug-in head
- Selection in accordance with product structure
- Product Configurator on the product page: www.endress.com/cpk3



Technical Information TI00118C

Measuring cable CPK9

- Terminated measuring cable for connecting analog sensors with TOP68 plug-in head
- Selection in accordance with product structure
- Product Configurator on the product page: www.endress.com/cpk9



Technical Information TI00118C

CPS64

- pH single electrode for all applications
- Product Configurator on the product page: www.endress.com/cps64



Technical Information TI00032C

OrbiSint CPS13

- pH reference electrode for all applications
- With dirt-repellent PTFE diaphragm
- Product Configurator on the product page: www.endress.com/cps13



Technical Information TI00367C

8 Technical data

8.1 Input

8.1.1 Measured variable

Temperature via temperature-dependent resistor (TDR)

8.1.2 Measuring range

- In conjunction with Liquiline M CM42:
-35 to 250 °C (-31 to 482 °F)
- In conjunction with Liquisys M CPM223/253:
-50 to 150 °C (-58 to 302 °F)

8.2 Process

8.2.1 Process temperature range

-15 to 135 °C (5 to 275 °F)

8.2.2 Process pressure range

0.8 to 14 bar (11.6 to 203 psi)

8.3 Mechanical construction

8.3.1 Dimensions

→ Section "Installation"

8.3.2 Weight

185 g (6.5 oz)

8.3.3 Materials

Wetted materials

Shaft	Glass to suit process
Sealing ring	Viton
Thrust collar	EPDM

Materials not in contact with the medium

Information according to REACH Regulation (EC) 1907/2006 Art. 33/1:

The potting compound in the sensor shaft contains the SVHC substance terphenyl, hydrogenated (CAS number ¹⁾ 61788-32-7) with more than 0.1 % (w/w). The product does not present a hazard if it is used as designated.

1) CAS = Chemical Abstracts Service, international identification standard for chemical substances

8.3.4 Process connections

Pg 13.5



71498698

www.addresses.endress.com
