

Technical Information

iTHERM TT411

Welded thermowell

Use in hygienic and aseptic applications in the food & beverages and pharmaceutical industries



Applications

- Specially designed for use in hygienic and aseptic applications in the Food & Beverages and Life Sciences industries
- Pressure range up to 40 bar (580 psi)
- For increased protection requirements of the temperature sensor regarding physical and chemical effects
- For use in pipes and containers or tanks
- Ideally suited to all measuring points that require regular recalibration by simply replacing the insert in closed processes

Your benefits

- iTHERM QuickNeck – cost and time savings thanks to simple, tool-free recalibration of the insert used
- Over 50 hygienic process connections
- Global portfolio with metric and imperial versions
- International certification: 3-A Sanitary Standard, EHEDG, ASME BPE, FDA, TSE Certificate of Suitability
- Optional: 1.4435 material, delta ferrite content < 0.5%
- Fast response time owing to reduced tips with thin walls
- State of the art T-pieces and elbow pieces, no welds and dead legs with best-in-class hygienic design

Installation

Orientation

No restrictions. However, self-draining in the process must be guaranteed. If there is an opening to detect leaks at the process connection, this opening must be at the lowest possible point.

Installation instructions

The immersion length of the thermometer can influence the accuracy. If the immersion length is too small then errors in the measurement are caused by heat conduction via the process connection and the container wall. If installing into a pipe then the immersion length should ideally be half of the pipe diameter.

Installation possibilities: Pipes, tanks or other plant components

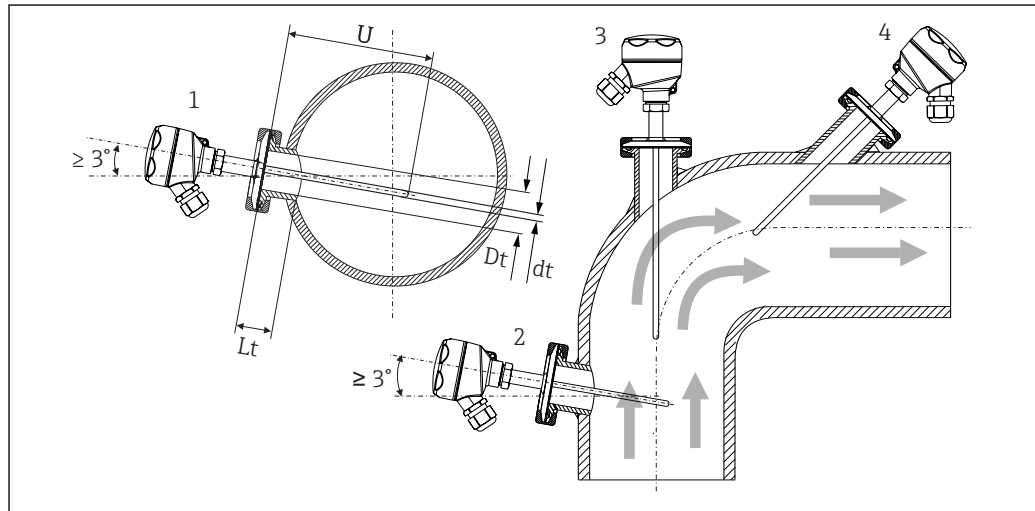

A0008946

1 Installation examples

1, 2 Perpendicular to flow direction, installed at a min. angle of 3° to ensure self-draining

3 On elbows

4 Inclined installation in pipes with a small nominal diameter

U Immersion length

i In the case of pipes with a small nominal diameter, it is advisable for the tip of the thermometer to project well into the process so that it extends past the pipe axis. Installation at an angle (4) could be another solution. When determining the immersion length or installation depth all the parameters of the thermometer and of the medium to be measured must be taken into account (e.g. flow velocity, process pressure).

i The requirements of the EHEDG and the 3-A Sanitary Standard must be adhered to.

Installation instructions EHEDG/cleanability: $L_t \leq (D_t - d_t)$

Installation instructions 3-A/cleanability: $L_t \leq 2(D_t - d_t)$

Pay attention to the exact position of the sensor element in the thermometer tip.

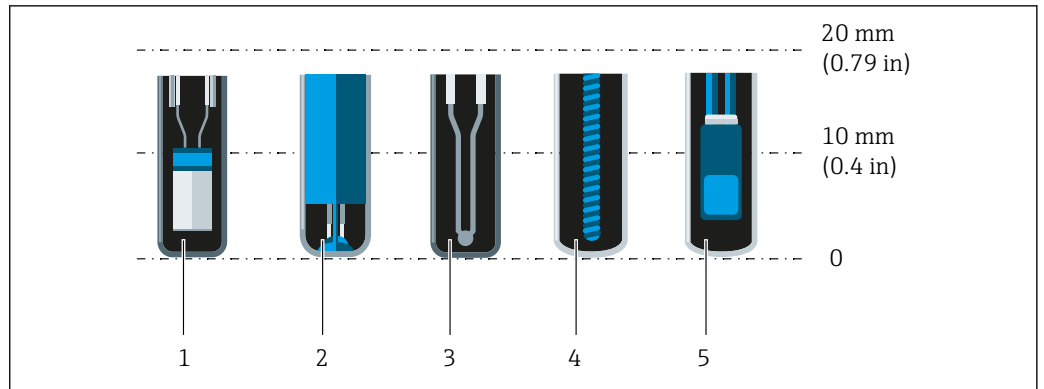

A0041814

- 1 StrongSens or TrustSens at 5 to 7 mm (0.2 to 0.28 in)
- 2 QuickSens at 0.5 to 1.5 mm (0.02 to 0.06 in)
- 3 Thermocouple (not grounded) at 3 to 5 mm (0.12 to 0.2 in)
- 4 Wire wound sensor at 5 to 20 mm (0.2 to 0.79 in)
- 5 Standard thin-film sensor at 5 to 10 mm (0.2 to 0.39 in)

To keep the influence of heat dissipation to a minimum and to achieve the best possible measurement results, 20 to 25 mm (0.79 to 0.98 in) should be in contact with the medium in addition to the actual sensor element.

This results in the following recommended minimum immersion lengths

- TrustSens or StrongSens 30 mm (1.18 in)
- QuickSens 25 mm (0.98 in)
- Wire wound sensor 45 mm (1.77 in)
- Standard thin-film sensor 35 mm (1.38 in)

It is particularly important to take this into consideration for T-pieces, as the immersion length is very short on account of their design, and the measured error is higher as a result. It is therefore recommended to use elbow pieces with QuickSens sensors.

i The counterpieces for the process connections and the seals or sealing rings are not included in the scope of supply for the thermometer. Liquiphant M weld-in adapters with associated seal kits are available as accessories. .

i For the requirements for installation according to the EHEDG and 3-A Sanitary Standard, see the Operating Instructions for the modular hygienic thermometers.

Operating Instructions BA02023T

Process

Process temperature range Maximum -200 to +650 °C (-328 to +1202 °F) → 11

Thermal shock Thermal shock resistance in CIP/SIP process with a temperature increase and decrease from +5 to +130 °C (+41 to +266 °F) within 2 seconds.

Process pressure range The maximum possible process pressure depends on various influencing factors, such as the design, process connection and process temperature. For information on the maximum possible process pressures for the individual process connections, see the 'Process connection' section. → 11

i It is possible to check the mechanical loading capacity as a function of the installation and process conditions online in the TW Sizing Module for protection tubes in the Endress+Hauser Applicator software. This is valid for DIN thermowell calculations. See 'Accessories' section.

Example of the permitted flow velocity depending on the immersion length and process medium

The highest flow velocity tolerated by the protection tube diminishes with increasing insert immersion length exposed to the stream of the fluid. In addition, it is dependent on the diameter of the tip of the protection tube, the medium type, process temperature and process pressure. The

following figures exemplify the maximum permitted flow velocities in water and superheated steam at a process pressure of 40 bar (580 PSI).

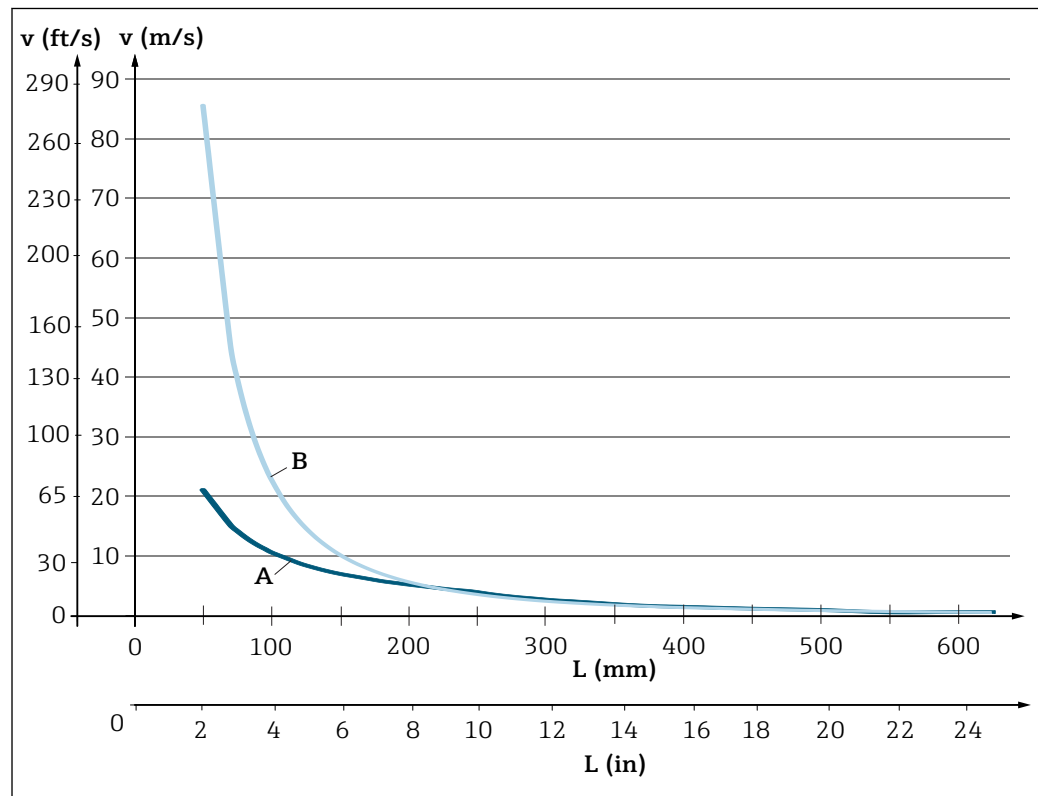

2 Permitted flow velocities, protection tube diameter 9 mm (0.35 in)

A Medium water at $T = 50\text{ }^{\circ}\text{C}$ ($122\text{ }^{\circ}\text{F}$)

B Medium superheated steam at $T = 160\text{ }^{\circ}\text{C}$ ($320\text{ }^{\circ}\text{F}$)

L Immersion length exposed to flow

v Flow velocity

Medium - state of aggregation

Gaseous or liquid (also with high viscosity, e.g. yogurt).

Mechanical construction

Design, dimensions

All dimensions in mm (in). The design depends on the thermowell version:

- Diameter 6 mm ($\frac{1}{4}$ in)
- Diameter 9 mm (0.35 in)
- Diameter 12.7 mm ($\frac{1}{2}$ in)
- T-piece and elbow piece thermowell version as per DIN 11865/ASME BPE for weld-in

i Various dimensions, such as the immersion length U for example, are variable values and are therefore indicated as items in the following dimensional drawings.

Variable dimensions:

Position	Description
L	Thermowell length (U+T)
B	Thermowell base thickness: predefined, depends on thermowell version (see also the individual table data)
T	Length of thermowell lagging: variable or predefined, depends on thermowell version (see also the individual table data)
U	Immersion length: variable, depending on the configuration

Thermowell diameter 6 mm (1/4 in)

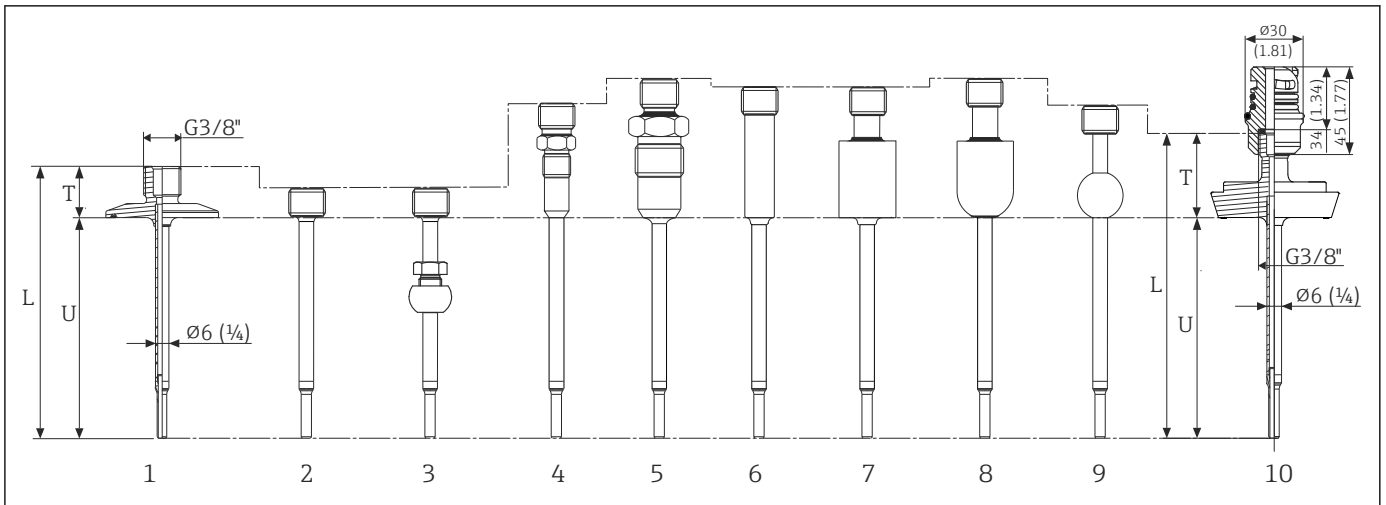

A0019699

3 Thermowell with extension neck connection G3/8" and various process connection versions:

- 1 Clamp version
- 2 Without process connection
- 3 Spherical compression fitting TK40
- 4 Metal sealing system M12x1
- 5 Metal sealing system G1/2"
- 6 Cylindrical weld-in adapter $\phi 12 \times 40$ mm
- 7 Cylindrical weld-in adapter $\phi 30 \times 40$ mm
- 8 Spherical-cylindrical weld-in adapter $\phi 30 \times 40$ mm
- 9 Spherical weld-in adapter $\phi 25$ mm
- 10 Sanitary connection according to DIN 11851 with threaded bottom part iTHERM QuickNeck, torque 5 Nm (3.69 lbf ft), glued with loctite® 270.

Position	Version	Length
Length of thermowell lagging T ¹⁾	Metal sealing system M12x1	46 mm (1.81 in)
	Metal sealing system G1/2"	60 mm (2.36 in)
	Tri-clamp (0.5"-0.75")	24 mm (0.94 in)
	Microclamp (DN8-18)	23 mm (0.91 in)
	Clamp DN12 according to ISO 2852	24 mm (0.94 in)
	Clamp DN25/DN40 according to ISO 2852	21 mm (0.83 in)
	Sanitary connection DN25/DN32/DN40 according to DIN 11851	29 mm (1.14 in)
	Spherical-cylindrical weld-in adapter	58 mm (2.28 in)
	Cylindrical weld-in adapter $\phi 12$ mm (0.47 in)	55 mm (2.17 in)
	Without process connection (only G3/8" thread)	11 mm (0.43 in)
	Cylindrical weld-in adapter	55 mm (2.17 in)
	Spherical weld-in adapter	47 mm (1.85 in)
	Immersion length U	Independent of the version
Base thickness B	Reduced tip $\phi 4.3$ mm (0.17 in)	2 mm (0.08 in)

1) Depends on the process connection

Thermowell diameter 9 mm (0.35 in)

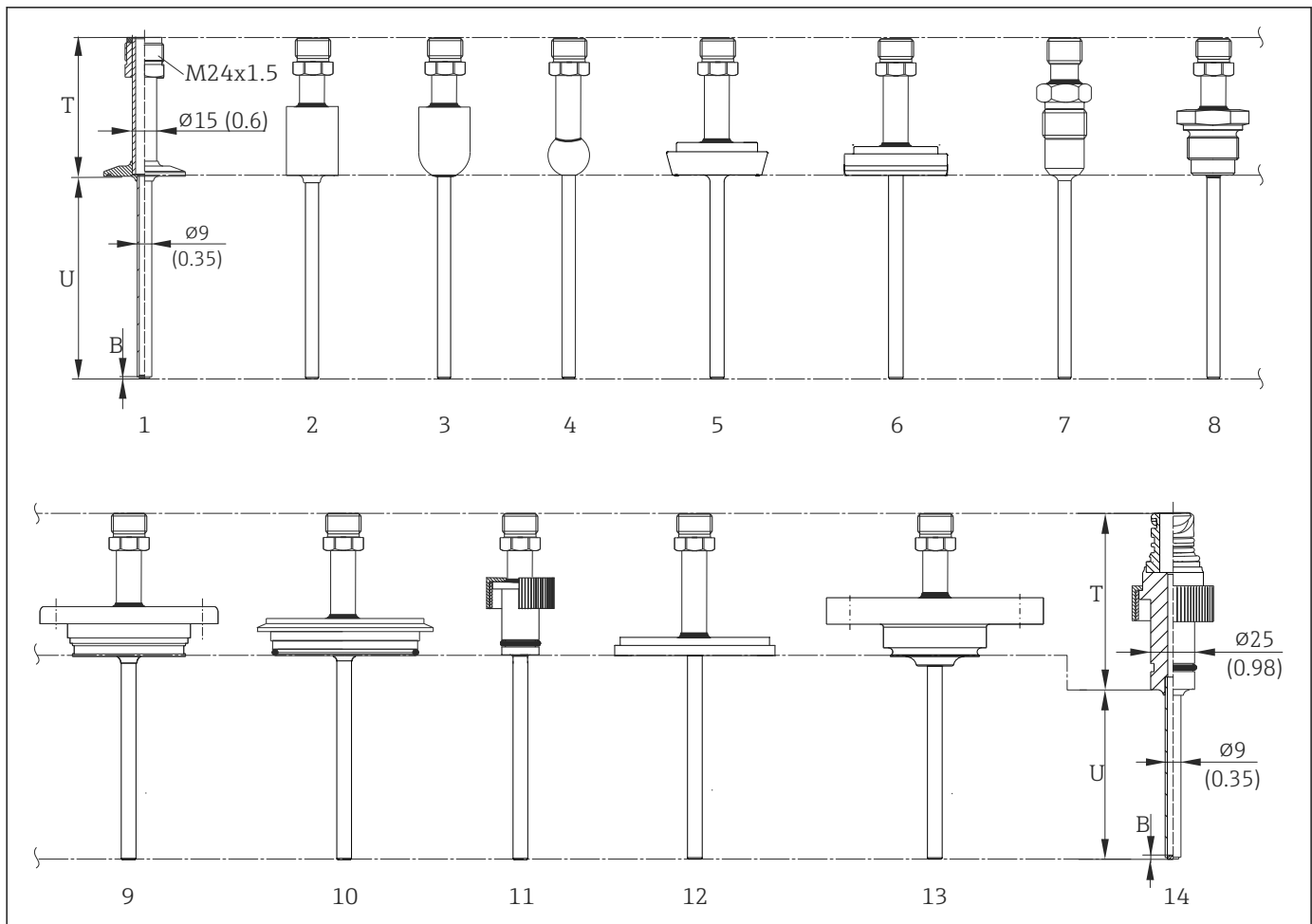

A0019729

4 Thermowell with M24x1.5 connection thread and the following process connection versions:

- 1 Clamp as per ISO2852
- 2 Cylindrical weld-in adapter $\phi 30 \times 40$ mm
- 3 Spherical-cylindrical weld-in adapter $\phi 30 \times 40$ mm
- 4 Spherical weld-in adapter $\phi 25$ mm
- 5 Sanitary connection according to DIN 11851
- 6 Aseptic pipe union according to DIN 11864-1 Form A
- 7 Metal sealing system G $\frac{1}{2}$ "
- 8 Thread according to ISO 228 for Liquiphant weld-in adapter
- 9 APV Inline
- 10 Varivent[®]
- 11 Ingold connection
- 12 SMS 1147
- 13 Neumo Biocontrol
- 14 Ingold connection, for example with bottom part iTHERM QuickNeck

Position	Version	Length
Length of thermowell lagging T, without quick-fastening iTHERM QuickNeck		Variable, depending on the configuration
With quick-fastening iTHERM QuickNeck, depending on the process connection	SMS 1147, DN25	40 mm (1.57 in)
	SMS 1147, DN38	41 mm (1.61 in)
	SMS 1147, DN51	42 mm (1.65 in)
	Varivent [®] , type F, $\phi D = 50$ mm (1.97 in)	52 mm (2.05 in)
	Varivent [®] , type N, $\phi D = 68$ mm (2.67 in)	
	Varivent [®] , type B, $\phi D = 31$ mm (1.22 in)	56 mm (2.2 in)

Position	Version	Length
	G1" thread according to ISO 228 for Liquiphant weld-in adapter	77 mm (3.03 in)
	Spherical-cylindrical weld-in adapter	70 mm (2.76 in)
	Cylindrical weld-in adapter	67 mm (2.64 in)
	Aseptic pipe union according to DIN11864-A, DN25	42 mm (1.65 in)
	Aseptic pipe union according to DIN11864-A, DN40	43 mm (1.7 in)
	Sanitary connection according to DIN 11851, DN32	47 mm (1.85 in)
	Sanitary connection according to DIN 11851, DN40	
	Sanitary connection according to DIN 11851, DN50	48 mm (1.89 in)
	Clamp according to ISO 2852, DN12	
	Clamp according to ISO 2852, DN25	37 mm (1.46 in)
	Clamp according to ISO 2852, DN40	39 mm (1.54 in)
	Clamp according to ISO 2852, DN63.5	
	Clamp according to ISO 2852, DN70	47 mm (1.85 in)
	Microclamp (DN8-18)	
	Tri-clamp (0.5"-0.75")	46 mm (1.81 in)
	Ingold connection ϕ 25 mm (0.98 in) x 30 mm (1.18 in)	78 mm (3.07 in)
	Ingold connection ϕ 25 mm (0.98 in) x 46 mm (1.81 in)	94 mm (3.7 in)
	Metal sealing system G $\frac{1}{2}$ "	74 mm (2.91 in)
	APV-Inline, DN50	51 mm (2.01 in)
Immersion length U	Independent of the version	Variable, depending on the configuration
Base thickness B	Reduced tip ϕ 5.3 mm (0.21 in)x 20 mm (0.79 in)	2 mm (0.08 in)
	Tapered tip ϕ 6.6 mm (0.26 in) x 60 mm (2.36 in)	
	Straight tip	

Thermowell diameter 12.7 mm (½ in)

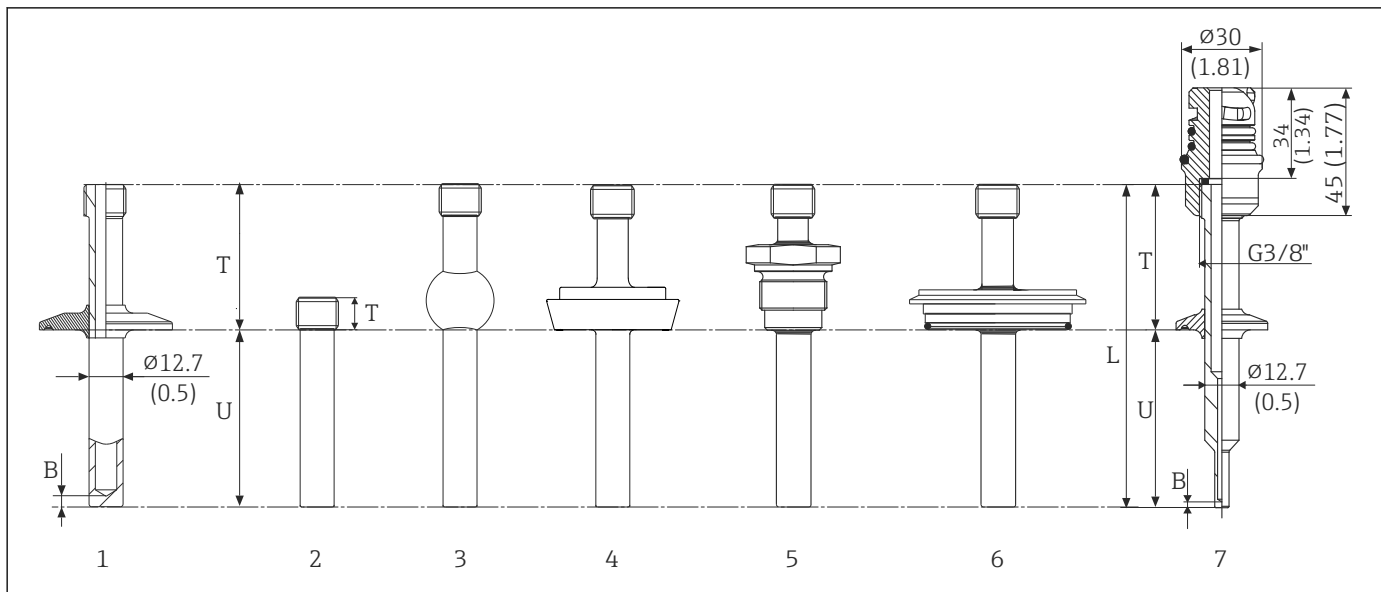

5 Thermowell with extension neck connection G3/8" and various process connection versions:

- 1 Clamp version
- 2 Cylindrical weld-in adapter $\phi 12.7$ mm (0.5 in)
- 3 Spherical weld-in adapter $\phi 25$ mm
- 4 Sanitary connection according to DIN 11851
- 5 Thread according to ISO 228 for Liquiphant weld-in adapter
- 6 Varivent®
- 7 Microclamp, threaded with QuickNeck bottom part, torque 5 Nm (3.69 lbf ft), and glued with loctite® 270, with reduced tip

Welded thermowell at the tip

Position	Version	Length
Length of thermowell lagging T	Weld-in adapter, cylindrical, $\phi 12.7$ mm (½ in)	12 mm (0.47 in)
	All other process connections	65 mm (2.56 in)
Immersion length U	Independent of the process connection	Variable, depending on the configuration
Base thickness B	Reduced tip $\phi 5.3$ mm (0.21 in)x 20 mm (0.79 in)	2 mm (0.079 in)
	Reduced tip $\phi 8$ mm (0.31 in)x 32 mm (1.26 in)	4 mm (0.16 in)
	Straight tip	6 mm (0.24 in)

Thermowell version as T-piece or elbow piece, optimized

No welds, no dead legs

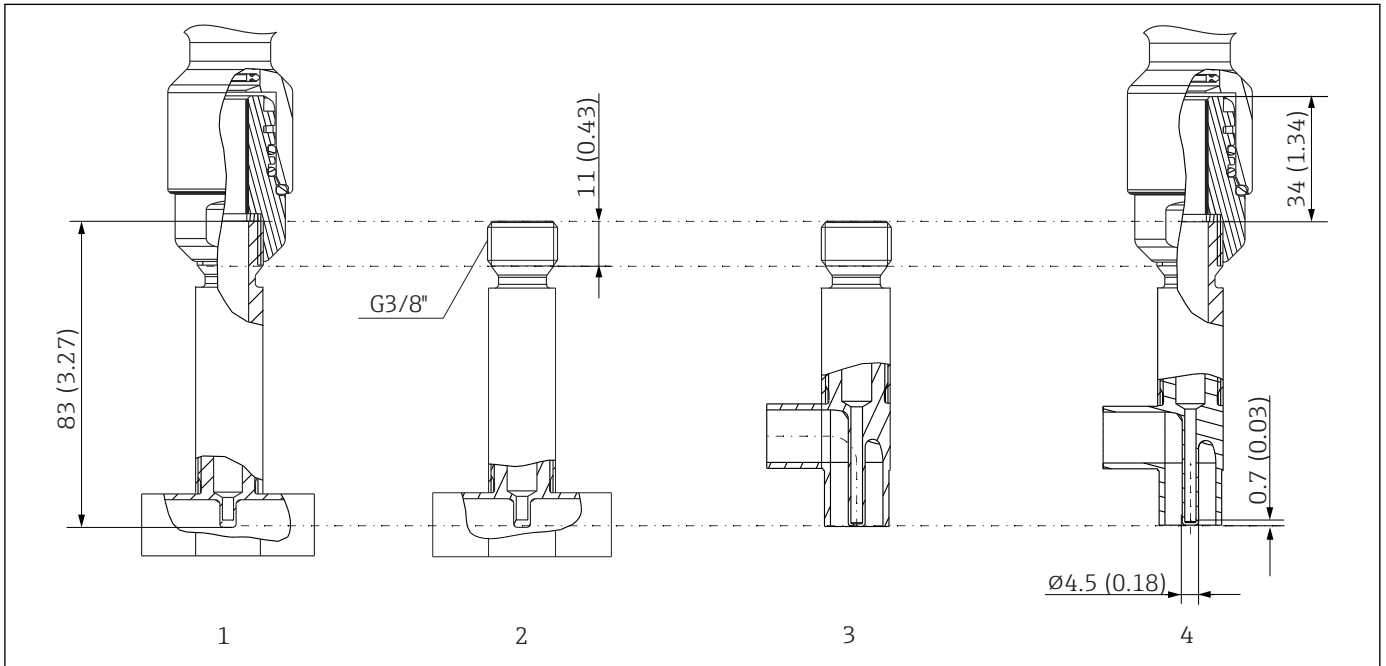

6 Thermowell as per DIN 11865 or ASME BPE

- 1 T-piece with threaded bottom part QuickNeck, torque 5 Nm (3.69 lbf ft), and glued with threadlocking adhesive
- 2 T-piece with extension neck connection G3/8"
- 3 Elbow piece with extension neck connection G3/8"
- 4 Elbow piece with threaded bottom part QuickNeck, torque 5 Nm (3.69 lbf ft), and glued with threadlocking adhesive

- Pipe sizes as per DIN 11865 series A (DIN), B (ISO) and C (ASME BPE) → 16
- 3-A symbol for nominal diameters \geq DN25 for 3-A®, EHEDG and ASME BPE
- EHEDG certification for nominal diameters \geq DN25 for 3-A®, EHEDG and ASME BPE
- ASME BPE compliance for nominal diameters \geq DN25 for 3-A®, EHEDG and ASME BPE
- IP69K protection class
- 1.4435+316L material, delta ferrite content $<$ 0.5%
- Temperature range: -60 to $+200$ °C (-76 to $+392$ °F)
- Pressure range: PN25 as per DIN11865

i Due to the short immersion length U in the case of small pipe diameters, the use of iTHERM QuickSens inserts is recommended.

As a general rule, the longer the immersion length U the better the accuracy. For small pipe diameters it is advisable to use elbow pieces to enable a maximum immersion length U.

Suitable immersion lengths for the following thermometers:

- Easytemp TMR35: 83 mm (3.27 in)
- iTHERM TM411: 85 mm (3.35 in)
- iTHERM TM311: 85 mm (3.35 in)
- TrustSens TM371: 85 mm (3.35 in)

Possible combinations of the thermowell versions with the available process connections

Process connection and size	Thermowell diameter			iTHERM QuickNeck for $\phi 9$ mm (0.35 in) ¹⁾
	6 mm ($\frac{1}{4}$ in)	9 mm (0.35 in)	12.7 mm ($\frac{1}{2}$ in)	
Without process connection (for installation with compression fitting)	<input checked="" type="checkbox"/>	-	-	-
Weld-in adapter				
Cylindrical $\phi 12.7$ mm ($\frac{1}{2}$ in)	-	-	<input checked="" type="checkbox"/>	-
Cylindrical $\phi 30 \times 40$ mm	<input checked="" type="checkbox"/>	<input checked="" type="checkbox"/>	-	<input checked="" type="checkbox"/>
Cylindrical $\phi 12 \times 40$ mm		-	-	-
Spherical-cylindrical $\phi 30 \times 40$ mm	<input checked="" type="checkbox"/>	<input checked="" type="checkbox"/>	-	<input checked="" type="checkbox"/>
Spherical $\phi 25$ mm (0.98 in)	<input checked="" type="checkbox"/>	<input checked="" type="checkbox"/>	<input checked="" type="checkbox"/>	-
Clamp according to ISO 2852				
Microclamp/Tri-clamp DN18 (0.75 in)	<input checked="" type="checkbox"/> ²⁾	<input checked="" type="checkbox"/>	-	<input checked="" type="checkbox"/>
DN12 - 21.3			<input checked="" type="checkbox"/>	
DN25 - 38 (1 - 1.5 in)	<input checked="" type="checkbox"/>	<input checked="" type="checkbox"/>	<input checked="" type="checkbox"/>	<input checked="" type="checkbox"/>
DN40 - 51 (2 in)				
DN63.5 (2.5 in)	-	<input checked="" type="checkbox"/>	<input checked="" type="checkbox"/>	<input checked="" type="checkbox"/>
DN70 - 76.5 (3 in)				
Sanitary connection according to DIN 11851				
DN25	<input checked="" type="checkbox"/>	<input checked="" type="checkbox"/>	-	<input checked="" type="checkbox"/>
DN32, DN40			<input checked="" type="checkbox"/>	
DN50	-			
Aseptic pipe union according to DIN 11864-1 Form A				
DN25, DN40	-	<input checked="" type="checkbox"/>	-	<input checked="" type="checkbox"/>
Metal sealing system				
M12x1	<input checked="" type="checkbox"/>	-	-	-
G $\frac{1}{2}$ "		<input checked="" type="checkbox"/>	-	<input checked="" type="checkbox"/>
Thread according to ISO 228 for Liquiphant weld-in adapter				
G $\frac{3}{4}$ " for FTL20, FTL31, FTL33	-	<input checked="" type="checkbox"/>	<input checked="" type="checkbox"/>	-
G $\frac{3}{4}$ " for FTL50				-
G1" for FTL50				<input checked="" type="checkbox"/>
APV Inline				
DN50	-	<input checked="" type="checkbox"/>	-	<input checked="" type="checkbox"/>
Varivent®				
Type B, $\phi 31$ mm; Type F, $\phi 50$ mm ; Type N, $\phi 68$ mm	-	<input checked="" type="checkbox"/>	<input checked="" type="checkbox"/>	<input checked="" type="checkbox"/>
Ingold connection				
25 x 30 mm or 25 x 46 mm	-	<input checked="" type="checkbox"/>	-	<input checked="" type="checkbox"/>
SMS 1147				
DN25, DN38, DN51	-	<input checked="" type="checkbox"/>	-	<input checked="" type="checkbox"/>
Neumo Biocontrol				
D25 PN16, D50 PN16, D65 PN16	-	<input checked="" type="checkbox"/>	-	-

1) In the case of 6 mm ($\frac{1}{4}$ in) and 12.7 mm ($\frac{1}{2}$ in) diameters, the iTHERM QuickNeck is available for all process connection versions.2) Microclamp/Tri-clamp DN8 (0.5") only possible in conjunction with a thermowell diameter = 6 mm ($\frac{1}{4}$ in).

Weight 0.5 to 2.5 kg (1 to 5.5 lbs) for standard options.

Material The temperatures for continuous operation specified in the following table are only intended as reference values for use of the various materials in air and without any significant compressive load. The maximum operating temperatures can be reduced considerably in cases where abnormal conditions such as high mechanical load occur or in aggressive media.

Designation	Short form	Recommended max. temperature for continuous use in air	Properties
AISI 316L (corresponds to 1.4404 or 1.4435)	X2CrNiMo17-13-2, X2CrNiMo18-14-3	650 °C (1202 °F) ¹⁾	<ul style="list-style-type: none"> ■ Austenitic, stainless steel ■ High corrosion resistance in general ■ Particularly high corrosion resistance in chlorine-based and acidic, non-oxidizing atmospheres through the addition of molybdenum (e.g. phosphoric and sulfuric acids, acetic and tartaric acids with a low concentration) ■ Increased resistance to intergranular corrosion and pitting ■ The wetted part in a protective tube is made of 316L or 1.4435+316L passivated with 3% sulfuric acid.
1.4435+316L, delta ferrite < 1% or < 0.5%	With regard to analytical limits, the specifications of both materials (1.4435 and 316L) are met simultaneously. In addition, the delta ferrite content of the wetted parts is limited to <1% - including the welding seams (following Basel Standard II); or <0.5%		

1) Can be used to a limited extent up to 800 °C (1472 °F) for low compressive loads and in non-corrosive media. Contact your Endress+Hauser sales team for further information.

Surface roughness *Values for wetted surfaces:*

Standard surface, mechanically polished ¹⁾	$R_a \leq 0.76 \mu\text{m}$ (30 μin)
Mechanically polished ¹⁾ , buffed ²⁾	$R_a \leq 0.38 \mu\text{m}$ (15 μin)
Mechanically polished ¹⁾ , buffed and electropolished	$R_a \leq 0.38 \mu\text{m}$ (15 μin) + electropolished

- 1) Or equivalent treatment that guarantees R_a max
 2) Not compliant with ASME BPE

Process connections All dimensions in mm (in).

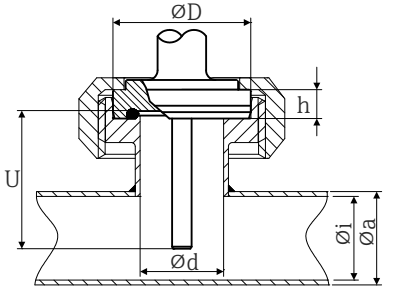
Type	Version	Dimensions					Technical properties
		ϕd	ϕD	ϕi	ϕa	h	
Aseptic pipe union according to DIN 11864-1, Form A 	DN25	26 mm (1.02 in)	42.9 mm (1.7 in)	26 mm (1.02 in)	29 mm (1.14 in)	9 mm (0.35 in)	<ul style="list-style-type: none"> ■ $P_{max.} = 40$ bar (580 psi) ■ With 3-A[®] symbol and EHEDG certification ■ ASME BPE compliance
	DN40	38 mm (1.5 in)	54.9 mm (2.16 in)	38 mm (1.5 in)	41 mm (1.61 in)	10 mm (0.39 in)	

For welding in

Type	Version	Dimensions	Technical properties
<p>Weld-in adapter</p>	1: Cylindrical ¹⁾	$\phi d = 12.7 \text{ mm } (\frac{1}{2} \text{ in})$, $U =$ immersion length from lower edge of thread, $T = 12 \text{ mm } (0.47 \text{ in})$	<ul style="list-style-type: none"> ■ P_{max} depends on the weld-in process ■ With 3-A® symbol and EHEDG certification ■ ASME BPE compliance
	2: Cylindrical ²⁾	$\phi d \times h = 12 \text{ mm } (0.47 \text{ in}) \times 40 \text{ mm } (1.57 \text{ in})$, $T = 55 \text{ mm } (2.17 \text{ in})$	
	3: Cylindrical	$\phi d \times h = 30 \text{ mm } (1.18 \text{ in}) \times 40 \text{ mm } (1.57 \text{ in})$	
	4: Spherical-cylindrical	$\phi d \times h = 30 \text{ mm } (1.18 \text{ in}) \times 40 \text{ mm } (1.57 \text{ in})$	
	5: Spherical	$\phi d = 25 \text{ mm } (0.98 \text{ in})$ $h = 24 \text{ mm } (0.94 \text{ in})$	

- 1) For thermowell $\phi 12.7 \text{ mm } (\frac{1}{2} \text{ in})$
 2) For thermowell $\phi 6 \text{ mm } (\frac{1}{4} \text{ in})$

Releasable process connection

Type	Technical properties																																								
<p>Sanitary connection according to DIN 11851</p> <p>1) Centering ring 2) Sealing ring</p>	<ul style="list-style-type: none"> ■ With 3-A® symbol and EHEDG certification (only with EHEDG-certified and self-centering sealing ring). ■ ASME BPE compliance 																																								
<table border="1"> <thead> <tr> <th rowspan="2">Version¹⁾</th> <th colspan="5">Dimensions</th> <th rowspan="2">P_{max}</th> </tr> <tr> <th>ϕD</th> <th>A</th> <th>B</th> <th>ϕi</th> <th>ϕa</th> </tr> </thead> <tbody> <tr> <td>DN25</td> <td>44 mm (1.73 in)</td> <td>30 mm (1.18 in)</td> <td>10 mm (0.39 in)</td> <td>26 mm (1.02 in)</td> <td>29 mm (1.14 in)</td> <td>40 bar (580 psi)</td> </tr> <tr> <td>DN32</td> <td>50 mm (1.97 in)</td> <td>36 mm (1.42 in)</td> <td>10 mm (0.39 in)</td> <td>32 mm (1.26 in)</td> <td>35 mm (1.38 in)</td> <td>40 bar (580 psi)</td> </tr> <tr> <td>DN40</td> <td>56 mm (2.2 in)</td> <td>42 mm (1.65 in)</td> <td>10 mm (0.39 in)</td> <td>38 mm (1.5 in)</td> <td>41 mm (1.61 in)</td> <td>40 bar (580 psi)</td> </tr> <tr> <td>DN50</td> <td>68 mm (2.68 in)</td> <td>54 mm (2.13 in)</td> <td>11 mm (0.43 in)</td> <td>50 mm (1.97 in)</td> <td>53 mm (2.1 in)</td> <td>25 bar (363 psi)</td> </tr> </tbody> </table>	Version ¹⁾	Dimensions					P_{max}	ϕD	A	B	ϕi	ϕa	DN25	44 mm (1.73 in)	30 mm (1.18 in)	10 mm (0.39 in)	26 mm (1.02 in)	29 mm (1.14 in)	40 bar (580 psi)	DN32	50 mm (1.97 in)	36 mm (1.42 in)	10 mm (0.39 in)	32 mm (1.26 in)	35 mm (1.38 in)	40 bar (580 psi)	DN40	56 mm (2.2 in)	42 mm (1.65 in)	10 mm (0.39 in)	38 mm (1.5 in)	41 mm (1.61 in)	40 bar (580 psi)	DN50	68 mm (2.68 in)	54 mm (2.13 in)	11 mm (0.43 in)	50 mm (1.97 in)	53 mm (2.1 in)	25 bar (363 psi)	
Version ¹⁾		Dimensions						P_{max}																																	
	ϕD	A	B	ϕi	ϕa																																				
DN25	44 mm (1.73 in)	30 mm (1.18 in)	10 mm (0.39 in)	26 mm (1.02 in)	29 mm (1.14 in)	40 bar (580 psi)																																			
DN32	50 mm (1.97 in)	36 mm (1.42 in)	10 mm (0.39 in)	32 mm (1.26 in)	35 mm (1.38 in)	40 bar (580 psi)																																			
DN40	56 mm (2.2 in)	42 mm (1.65 in)	10 mm (0.39 in)	38 mm (1.5 in)	41 mm (1.61 in)	40 bar (580 psi)																																			
DN50	68 mm (2.68 in)	54 mm (2.13 in)	11 mm (0.43 in)	50 mm (1.97 in)	53 mm (2.1 in)	25 bar (363 psi)																																			

- 1) Pipes in accordance with DIN 11850

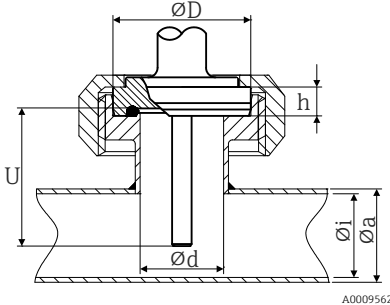
Type	Version	Dimensions					Technical properties
		ϕ	ϕD	ϕi	ϕa	h	
Aseptic pipe union according to DIN 11864-1, Form A 	DN25	26 mm (1.02 in)	42.9 mm (1.7 in)	26 mm (1.02 in)	29 mm (1.14 in)	9 mm (0.35 in)	<ul style="list-style-type: none"> ■ $P_{max.} = 40$ bar (580 psi) ■ With 3-A[®] symbol and EHEDG-tested ■ ASME BPE compliance
	DN40	38 mm (1.5 in)	54.9 mm (2.16 in)	38 mm (1.5 in)	41 mm (1.61 in)	10 mm (0.39 in)	

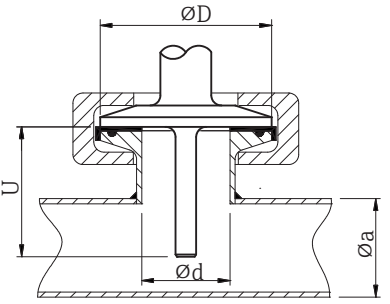
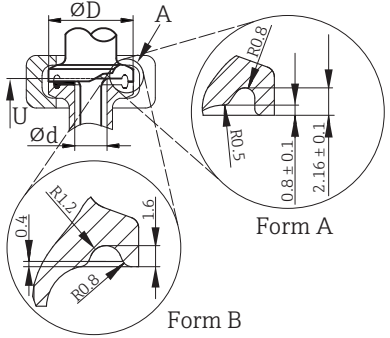
Type	Version	Dimensions		Technical properties	Conformity
		ϕd : ¹⁾	ϕD		
Clamp according to ISO 2852   Form A Form B A0009566	Microclamp ²⁾ DN8-18 (0.5"-0.75") ³⁾ , Form A	25 mm (0.98 in)	-	<ul style="list-style-type: none"> ■ $P_{max.} = 16$ bar (232 psi), depends on clamp ring and suitable seal ■ With 3-A[®] symbol 	ASME BPE Type A
	Tri-clamp DN8-18 (0.5"-0.75") ³⁾ , Form B		-		Following ISO 2852 ⁴⁾
	Clamp DN12-21.3, Form B	34 mm (1.34 in)	16 to 25.3 mm (0.63 to 0.99 in)		ISO 2852
	Clamp DN25-38 (1"-1.5"), Form B	50.5 mm (1.99 in)	29 to 42.4 mm (1.14 to 1.67 in)	<ul style="list-style-type: none"> ■ $P_{max.} = 16$ bar (232 psi), depends on clamp ring and suitable seal ■ With 3-A[®] symbol and EHEDG certification (in conjunction with Combifit seal) ■ Can be used with "Novaseptic Connect (NA Connect)" which enables flush-mount installation 	ASME BPE Type B; ISO 2852
	Clamp DN40-51 (2"), Form B	64 mm (2.52 in)	44.8 to 55.8 mm (1.76 to 2.2 in)		ASME BPE Type B; ISO 2852
	Clamp DN63,5 (2.5"), Form B	77.5 mm (3.05 in)	68.9 to 75.8 mm (2.71 to 2.98 in)		ASME BPE Type B; ISO 2852
	Clamp DN70-76.5 (3"), Form B	91 mm (3.58 in)	> 75.8 mm (2.98 in)		ASME BPE Type B; ISO 2852

- 1) Pipes in accordance with ISO 2037 and BS 4825 Part 1
- 2) Microclamp (not in ISO 2852); no standard pipes
- 3) DN8 (0.5") only possible with thermowell diameter = 6 mm (¼ in)
- 4) Groove diameter = 20 mm

Type	Version	Technical properties
Metal sealing system		
<p>M12x1.5</p>	<p>G½"</p>	<p>Thermowell diameter 6 mm (¼ in)</p> <p>$P_{max.} = 16 \text{ bar (232 psi)}$</p> <p> Maximum torque = 10 Nm (7.38 lbf ft)</p>
-		

Type	Version	Technical properties
<p>Process adapter</p>	D45	-

Type	Version G	Dimensions			Technical properties
		L1 thread length	A	l (SW/AF)	
<p>Thread according to ISO 228 (for Liquiphant weld-in adapter)</p>	G¾" for FTL20/31/33 adapter	16 mm (0.63 in)	25.5 mm (1 in)	32	<ul style="list-style-type: none"> $P_{max.} = 25 \text{ bar (362 psi)}$ at max. 150 °C (302 °F) $P_{max.} = 40 \text{ bar (580 psi)}$ at max. 100 °C (212 °F) With 3-A® symbol and EHEDG certification in conjunction with FTL31/33/50 adapter ASME BPE compliance
	G¾" for FTL50 adapter				
	G1" for FTL50 adapter	18.6 mm (0.73 in)	29.5 mm (1.16 in)	41	

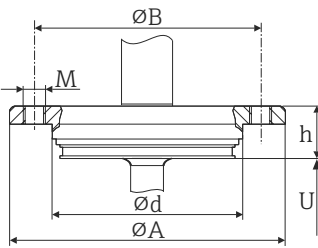
Type	Version	Dimensions					Technical properties
		ϕd	ϕA	ϕB	M	h	
APV Inline 	DN50	69 mm (2.72 in)	99.5 mm (3.92 in)	82 mm (3.23 in)	2xM8	19 mm (0.75 in)	<ul style="list-style-type: none"> ■ $P_{max.} = 25$ bar (362 psi) ■ With 3-A® symbol and EHEDG certification ■ ASME BPE compliance

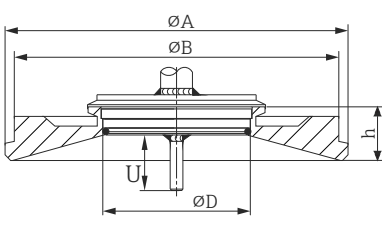
Type	Version	Dimensions				$P_{max.}$	Technical properties
		ϕD	ϕA	ϕB	h		
Varivent® 	Type B	31 mm (1.22 in)	105 mm (4.13 in)	-	22 mm (0.87 in)	10 bar (145 psi)	<ul style="list-style-type: none"> ■ With 3-A® symbol and EHEDG certification ■ ASME BPE compliance
	Type F	50 mm (1.97 in)	145 mm (5.71 in)	135 mm (5.31 in)	24 mm (0.95 in)		
	Type N	68 mm (2.67 in)	165 mm (6.5 in)	155 mm (6.1 in)	24.5 mm (0.96 in)		

i The VARINLINE® housing connection flange is suitable for weld-in into the conical or torispherical head in tanks or vessels with a small diameter (≤ 1.6 m (5.25 ft)) and up to a wall thickness of 8 mm (0.31 in).

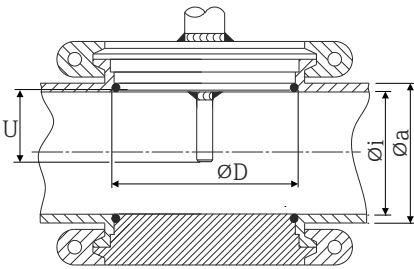
Type	Technical properties
Varivent® for VARINLINE® housing for installation in pipes 	<ul style="list-style-type: none"> ■ With 3-A® symbol and EHEDG certification ■ ASME BPE compliance

Version	Dimensions			$P_{max.}$
	ϕD	ϕi	ϕa	
Type N, according to DIN 11866, series A	68 mm (2.67 in)	DN40: 38 mm (1.5 in)	DN40: 41 mm (1.61 in)	DN40 to DN65: 16 bar (232 psi)
		DN50: 50 mm (1.97 in)	DN50: 53 mm (2.1 in)	
		DN65: 66 mm (2.6 in)	DN65: 70 mm (2.76 in)	
		DN80: 81 mm (3.2 in)	DN80: 85 mm (3.35 in)	DN80 to DN150: 10 bar (145 psi)
		DN100: 100 mm (3.94 in)	DN100: 104 mm (4.1 in)	
		DN125: 125 mm (4.92 in)	DN125: 129 mm (5.08 in)	
Type N, according to EN ISO 1127, series B	68 mm (2.67 in)	38.4 mm (1.51 in)	42.4 mm (1.67 in)	42.4 mm (1.67 in) to 60.3 mm (2.37 in): 16 bar (232 psi)
		44.3 mm (1.75 in)	48.3 mm (1.9 in)	

Type		Technical properties		
		56.3 mm (2.22 in)	60.3 mm (2.37 in)	
		72.1 mm (2.84 in)	76.1 mm (3 in)	76.1 mm (3 in) to 114.3 mm (4.5 in): 10 bar (145 psi)
		82.9 mm (3.26 in)	42.4 mm (3.5 in)	
		108.3 mm (4.26 in)	114.3 mm (4.5 in)	
Type N, according to DIN 11866, series C	68 mm (2.67 in)	OD 1½": 34.9 mm (1.37 in)	OD 1½": 38.1 mm (1.5 in)	OD 1½" to OD 2½": 16 bar (232 psi)
		OD 2": 47.2 mm (1.86 in)	OD 2": 50.8 mm (2 in)	
		OD 2½": 60.2 mm (2.37 in)	OD 2½": 63.5 mm (2.5 in)	
Type N, according to DIN 11866, series C	68 mm (2.67 in)	OD 3": 73 mm (2.87 in)	OD 3": 76.2 mm (3 in)	OD 3" to OD 4": 10 bar (145 psi)
		OD 4": 97.6 mm (3.84 in)	OD 4": 101.6 mm (4 in)	

 Due to the short immersion length U, the use of iTHERM QuickSens inserts is recommended.

T-piece, optimized (no welding, no dead legs)

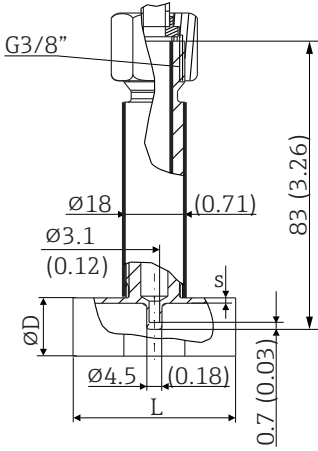
Type	Version	Dimensions in mm (in)			Technical properties	
		ØD	L	s ¹⁾		
<p>T-piece for weld-in as per DIN 11865 (series A, B and C)</p> 	Series A	DN10 PN25	13 mm (0.51 in)	48 mm (1.89 in)	1.5 mm (0.06 in)	<ul style="list-style-type: none"> ■ P_{max.} = 25 bar (362 psi) ■ With 3-A® symbol and EHEDG certification for ≥ DN25 ■ ASME BPE compliance for ≥ DN25
		DN15 PN25	19 mm (0.75 in)			
		DN20 PN25	23 mm (0.91 in)			
		DN25 PN25	29 mm (1.14 in)			
		DN32 PN25	32 mm (1.26 in)			
	Series B	DN13.5 PN25	13.5 mm (0.53 in)	48 mm (1.89 in)	1.6 mm (0.063 in)	
		DN17.2 PN25	17.2 mm (0.68 in)			
		DN21.3 PN25	21.3 mm (0.84 in)			
		DN26.9 PN25	26.9 mm (1.06 in)			
		DN33.7 PN25	33.7 mm (1.33 in)		2 mm (0.08 in)	
	Series C	DN12.7 PN25 (½")	12.7 mm (0.5 in)	48 mm (1.89 in)	1.65 mm (0.065 in)	
		DN19.05 PN25 (¾")	19.05 mm (0.75 in)			
		DN25.4 PN25 (1")	25.4 mm (1 in)			
DN38.1 PN25 (1½")		38.1 mm (1.5 in)				

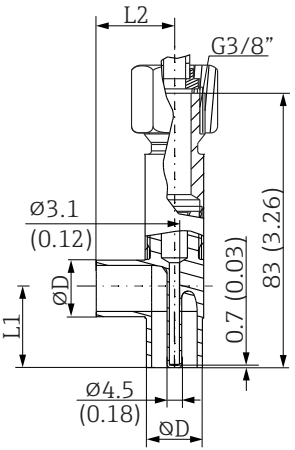

1) Wall thickness

Elbow piece, optimized (no welding, no dead legs)

Type	Version		Dimensions				Technical properties
			ØD	L1	L2	s ¹⁾	
Elbow piece for weld-in as per DIN 11865 (series A, B and C)  A0035899	Series A	DN10 PN25	13 mm (0.51 in)	24 mm (0.95 in)	1.5 mm (0.06 in)	<ul style="list-style-type: none"> ■ P_{max.} = 25 bar (362 psi) ■ With 3-A[®] symbol and EHEDG certification for ≥ DN25 ■ ASME BPE compliance for ≥ DN25 	
		DN15 PN25	19 mm (0.75 in)	25 mm (0.98 in)			
		DN20 PN25	23 mm (0.91 in)	27 mm (1.06 in)			
		DN25 PN25	29 mm (1.14 in)	30 mm (1.18 in)			
		DN32 PN25	35 mm (1.38 in)	33 mm (1.3 in)			
	Series B	DN13.5 PN25	13.5 mm (0.53 in)	32 mm (1.26 in)	1.6 mm (0.063 in)		
		DN17.2 PN25	17.2 mm (0.68 in)	34 mm (1.34 in)			
		DN21.3 PN25	21.3 mm (0.84 in)	36 mm (1.41 in)			
		DN26.9 PN25	26.9 mm (1.06 in)	29 mm (1.14 in)			
		DN33.7 PN25	33.7 mm (1.33 in)	32 mm (1.26 in)	2.0 mm (0.08 in)		
	Series C	DN12.7 PN25 (½")	12.7 mm (0.5 in)	24 mm (0.95 in)	1.65 mm (0.065 in)		
		DN19.05 PN25 (¾")	19.05 mm (0.75 in)	25 mm (0.98 in)			
		DN25.4 PN25 (1")	25.4 mm (1 in)	28 mm (1.1 in)			
		DN38.1 PN25 (1½")	38.1 mm (1.5 in)	35 mm (1.38 in)			

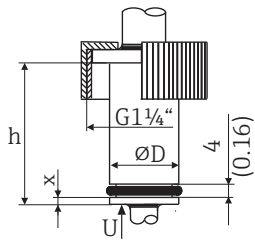
1) Wall thickness

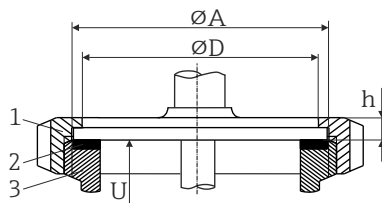
Type	Version, dimensions ØD x h	Technical properties
Ingold connection  A0009573	Ø25 mm (0.98 in) x30 mm (1.18 in) x = 1.5 mm (0.06 in)	P _{max.} = 25 bar (362 psi) A seal is included in the scope of delivery. Material V75SR: compliance with FDA, 3-A [®] Sanitary Standard 18-03 Class 1 and USP Class VI
	Ø25 mm (0.98 in) x46 mm (1.81 in) x = 6 mm (0.24 in)	

Type	Version	Dimensions			Technical properties
		ϕD	ϕA	h	
SMS 1147  1 Thread adapter nut 2 Sealing ring 3 Counterpart connection <small>A0009568</small>	DN25	32 mm (1.26 in)	35.5 mm (1.4 in)	7 mm (0.28 in)	$P_{max.} = 6 \text{ bar (87 psi)}$
	DN38	48 mm (1.89 in)	55 mm (2.17 in)	8 mm (0.31 in)	
	DN51	60 mm (2.36 in)	65 mm (2.56 in)	9 mm (0.35 in)	
 The counterpart connection must fit the sealing ring and fix it in place.					

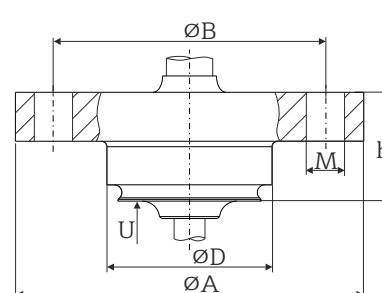
Type	Version	Dimensions					Technical properties
		ϕA	ϕB	ϕD	ϕd	h	
Neumo Biocontrol  <small>A0018497</small>	D25 PN16	64 mm (2.52 in)	50 mm (1.97 in)	30.4 mm (1.2 in)	7 mm (0.28 in)	20 mm (0.79 in)	<ul style="list-style-type: none"> ■ $P_{max.} = 16 \text{ bar (232 psi)}$ ■ With 3-A® symbol
	D50 PN16	90 mm (3.54 in)	70 mm (2.76 in)	49.9 mm (1.97 in)	9 mm (0.35 in)	27 mm (1.06 in)	
	D65 PN25	120 mm (4.72 in)	95 mm (3.74 in)	67.9 mm (2.67 in)	11 mm (0.43 in)		

 The 316L compression fittings can only be used once due to deformation. This applies to all the components of the compression fittings! A replacement compression fitting must be fastened at another point (grooves in thermowell). PEEK compression fittings must never be used at a temperature that is lower than the temperature present when the compression fitting is secured. This is because the fitting would no longer be leak-tight as a result of heat contraction of the PEEK material.

If stricter requirements must be met, the use of SWAGELOCK or similar fasteners is urgently recommended.

Tip shape

The thermal response time, the reduction of the flow cross-section and the mechanical load that occurs in the process are the criteria that matter when selecting the shape of the tip. Advantages of using reduced or tapered thermometer tips:

- A smaller tip shape has less impact on the flow characteristics of the pipe carrying the medium.
- The flow characteristics are optimized, thereby increasing the stability of the thermowell.
- Endress+Hauser offers users a range of thermowell tips to meet every requirement:
 - Reduced tip with $\phi 4.3 \text{ mm (0.17 in)}$ and $\phi 5.3 \text{ mm (0.21 in)}$: walls of lower thickness significantly reduce the response times of the overall measuring point.
 - Tapered tip with $\phi 6.6 \text{ mm (0.26 in)}$ and reduced tip with $\phi 8 \text{ mm (0.31 in)}$: walls of greater thickness are particularly well suited to applications with a higher degree of mechanical load or wear (e.g. pitting, abrasion etc.).

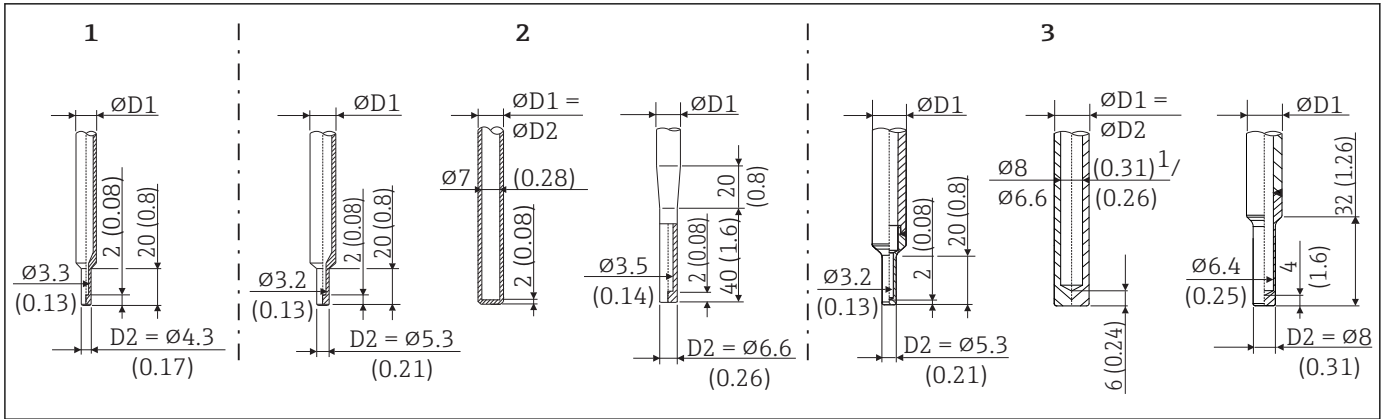



A0017174

7 Thermowell tips available (reduced, straight or tapered)

Item No.	Thermowell (ØD1)	Insert (ØID)
1	Ø6 mm (¼ in)	Reduced tip Ø3 mm (⅛ in)
2	Ø9 mm (0.35 in)	<ul style="list-style-type: none"> ■ Reduced tip with Ø5.3 mm (0.21 in) ■ Straight tip ■ Tapered tip with Ø6.6 mm (0.26 in) <ul style="list-style-type: none"> ■ Ø3 mm (⅛ in) ■ Ø6 mm (¼ in) ■ Ø3 mm (⅛ in)
3	Ø12.7 mm (½ in)	<ul style="list-style-type: none"> ■ Reduced tip with Ø5.3 mm (0.21 in) ■ Straight tip ■ Reduced tip with Ø8 mm (0.31 in) <ul style="list-style-type: none"> ■ Ø3 mm (⅛ in) ■ Ø6 mm (¼ in) ■ Ø6 mm (¼ in)

i It is possible to check the mechanical loading capacity as a function of the installation and process conditions online in the TW Sizing Module for thermowells in the Endress+Hauser Applicator software. See "Accessories" section.

Certificates and approvals

CE mark	The product meets the requirements of the harmonized European standards. As such, it complies with the legal specifications of the EU directives. The manufacturer confirms successful testing of the product by affixing to it the CE mark.
Hygiene standard	<ul style="list-style-type: none"> ■ EHEDG certification, type EL CLASS I. EHEDG-certified/tested process connections in accordance with EHEDG →  11 ■ 3-A[®] authorization no. 1144, 3-A[®] Sanitary Standard 74-07. Listed process connections →  11 ■ ASME BPE, declaration of conformity, can be ordered for options indicated ■ FDA-compliant ■ All surfaces in contact with the medium are free from materials derived from bovine animals or other livestock (ADI/ISE)
Other standards and guidelines	DIN 43772: Thermowells
CRN approval	The CRN approval is only available for certain thermowell versions. These versions are identified and displayed accordingly during the configuration of the device.
	Detailed ordering information is available for your nearest sales organization www.addresses.endress.com or in the Download Area under www.endress.com :
	<ol style="list-style-type: none"> 1. Select the country 2. Select Downloads 3. In the search area: select Approvals/approval type 4. Enter the product code or device 5. Start the search
Areas in contact with medium	<p>The areas of the thermometer in contact with food/product (FCM) comply with the following European regulations:</p> <ul style="list-style-type: none"> ■ (EC) No. 1935/2004, Article 3, paragraph 1, Articles 5 and 17 on materials and articles intended to come into contact with food. ■ (EC) No. 2023/2006 on good manufacturing practice for materials and articles intended to come into contact with food. ■ (EC) No. 10/2011 on plastic materials and articles intended to come into contact with food. ■ FDA-compliant ■ All surfaces in contact with medium are produced without animal fats (ADI/TSE)
Surface roughness	<ul style="list-style-type: none"> ■ Free from oil and grease for O₂ applications, optional ■ PWIS-free (PWIS = paint-wetting impairment substances as per DIL0301), optional
Material certification	The material certificate 3.1 (according to standard EN 10204) can be requested separately. The "short form" certificate includes a simplified declaration with no enclosures of documents related to the materials used in the construction of the single sensor and guarantees the traceability of the materials through the identification number of the thermometer. The data related to the origin of the materials can subsequently be requested by the client if necessary.
Thermowell testing and load capacity calculation	<ul style="list-style-type: none"> ■ Thermowell pressure tests are carried out in accordance with the specifications in DIN 43772. With regard to thermowells with tapered or reduced tips that do not comply with this standard, these are tested using the pressure of the corresponding straight thermowells. Tests according to other specifications can be carried out on request. The liquid penetration test verifies that there are no cracks in the welded seams of the thermowell. ■ EN1779 helium leak test, PMI test, concentricity test for drilled thermowells, dye penetration test, TW welding, internal hydrostatic pressure, etc. each with inspection certificate ■ Load capacity calculation for the thermowell as per DIN43772

Ordering information

Detailed ordering information is available for your nearest sales organization www.addresses.endress.com or in the Product Configurator under www.endress.com :

1. Click Corporate
2. Select the country
3. Click Products
4. Select the product using the filters and search field
5. Open the product page

The Configuration button to the right of the product image opens the Product Configurator.



Product Configurator - the tool for individual product configuration

- Up-to-the-minute configuration data
- Depending on the device: Direct input of measuring point-specific information such as measuring range or operating language
- Automatic verification of exclusion criteria
- Automatic creation of the order code and its breakdown in PDF or Excel output format
- Ability to order directly in the Endress+Hauser Online Shop

Accessories

Various accessories, which can be ordered with the device or subsequently from Endress+Hauser, are available for the device. Detailed information on the order code in question is available from your local Endress+Hauser sales center or on the product page of the Endress+Hauser website: www.endress.com.

Device-specific accessories

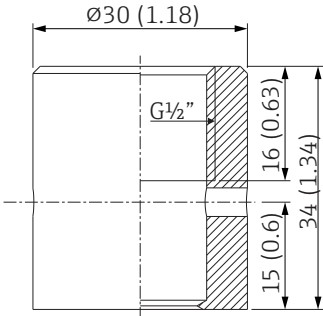
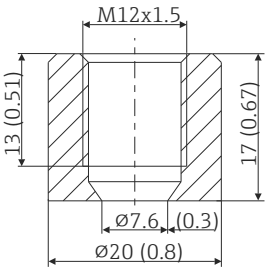
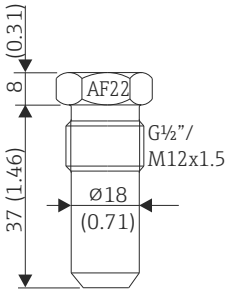
Accessories	Description
<p data-bbox="432 465 727 517">Welding boss with sealing taper (metal - metal)</p>  <p data-bbox="692 875 743 889">A0006621</p>  <p data-bbox="692 1189 743 1202">A0018236</p>	<p data-bbox="759 465 1142 573">Welding boss for G$\frac{1}{2}$"- and M12x1 thread Metal-sealing; conical Material of wetted parts: 316L/1.4435 Max. process pressure 16 bar (232 PSI)</p> <p data-bbox="759 584 903 607">Order number:</p> <ul data-bbox="759 611 970 663" style="list-style-type: none"> ■ 71424800 (G$\frac{1}{2}$") ■ 71405560 (M12x1)
<p data-bbox="520 1214 639 1236">Dummy plug</p>  <p data-bbox="676 1570 743 1583">A0009213-EN</p>	<p data-bbox="759 1214 1374 1272">Dummy plug for G$\frac{1}{2}$" or M12x1 conical metal-sealing welding boss Material: SS 316L/1.4435</p> <p data-bbox="759 1283 903 1305">Order number:</p> <ul data-bbox="759 1310 970 1361" style="list-style-type: none"> ■ 60022519 (G$\frac{1}{2}$") ■ 60021194 (M12x1)

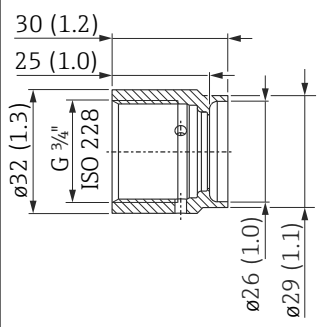
Accessories	Description
<p>Weld-in adapter for FTL31/33/20, pipe mounting</p>  <p style="text-align: right; font-size: small;">A0008265</p>	<ul style="list-style-type: none"> ▪ G$\frac{3}{4}$", d=29 mm, without flange ▪ Material: 316L ▪ Roughness in μm (μin), 1.5 (59.1) ▪ Order number 52028295 (with inspection certificate EN10204-3.1 material) ▪ Order number for seal (5-pc. set), silicone O-ring 52021717¹⁾, FDA-compliant

1) A seal is included in the delivery.

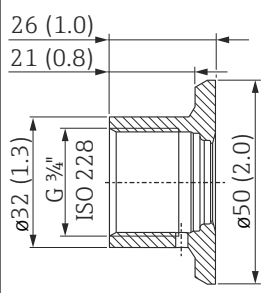
Accessories	Description
<p>Weld-in adapter for FTL31/33/20, vessel mounting</p>  <p style="text-align: right; font-size: small;">A0008810</p>	<ul style="list-style-type: none"> ▪ G$\frac{3}{4}$", d=50 mm, with flange ▪ Material 316L ▪ Roughness in μm (μin), 0.8 (31.5) ▪ Order number 52018765 (with inspection certificate EN10204-3.1 material) ▪ Order number for seal (5-pc. set), silicone O-ring 52021717¹⁾, FDA-compliant ▪ EHEDG-tested and with 3-A mark

1) A seal is included in the delivery.

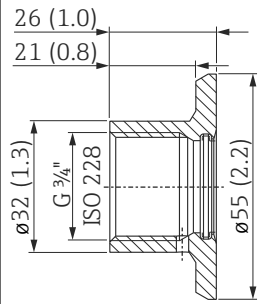
Accessories	Description
<p>Weld-in adapter for FTL50</p>  <p style="text-align: right; font-size: small;">A0008274</p>	<ul style="list-style-type: none"> ▪ G$\frac{3}{4}$", d=55 mm, with flange ▪ Material 316L ▪ Roughness in μm (μin), 0.8 (31.5) ▪ Order number 52001052 (without inspection certificate EN10204-3.1 material) ▪ Order number 52011897 (with inspection certificate EN10204-3.1 material) ▪ Order number for seal (5-pc. set), silicone O-ring 52014473¹⁾, FDA-compliant ▪ EHEDG-tested and with 3-A mark

1) A seal is included in the delivery.

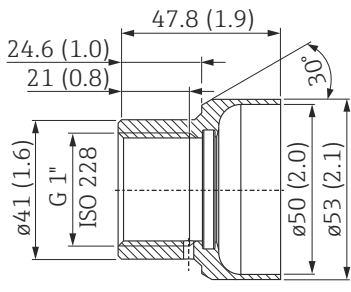
Accessories	Description
<p>Weld-in adapter for FTL50</p>  <p style="text-align: right;">A0011927</p>	<ul style="list-style-type: none"> ■ G1", d=53 mm, without flange ■ Material 316L ■ Roughness in μm (μin), 0.8 (31.5) ■ Order number 71093129 (with inspection certificate EN10204-3.1 material) ■ Order number for seal (5-pc. set), silicone O-ring 52014472 ¹⁾, FDA-compliant

1) A seal is included in the delivery.

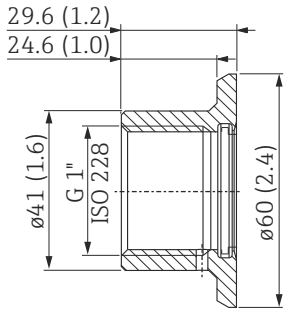
Accessories	Description
<p>Weld-in adapter for FTL50</p>  <p style="text-align: right;">A0008267</p>	<ul style="list-style-type: none"> ■ G1", d=60 mm, with flange ■ Material 316L ■ Roughness in μm (μin), 0.8 (31.5) ■ Order number: 52001051 (without inspection certificate EN10204-3.1 material) ■ Order number 52011896 (with inspection certificate EN10204-3.1 material) ■ Order number seal (5-pc. set): silicone O-ring 52014472 ¹⁾, FDA-compliant ■ EHEDG-tested and with 3-A mark

1) A seal is included in the delivery.

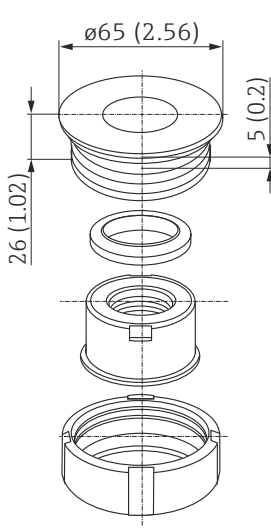
Accessories	Description
<p>Weld-in adapter for FTL50</p>  <p style="text-align: right;">A0008272</p>	<ul style="list-style-type: none"> ■ G1", can be aligned ■ Material 316L ■ Roughness in μm (μin), 0.8 (31.5) ■ Order number 52001221 (without inspection certificate EN10204-3.1 material) ■ Order number 52011898 (with inspection certificate EN10204-3.1 material) ■ Order number for seal (5-pc. set), silicone O-ring 52014424 ¹⁾, FDA-compliant

1) A seal is included in the delivery.

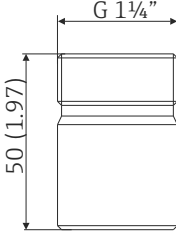
<p>Weld-in adapter for Ingold process connection (OD25 mm (0.98 in)x46 mm (1.81 in))</p>  <p style="text-align: right; font-size: small;">A0008956</p>	<p>Material of wetted parts: 316L/1.4435 Weight: 0.32 kg (0.7 lb) Order number: 60017887</p> <p>O-ring seal set</p> <ul style="list-style-type: none"> ■ Silicone O-ring in accordance with FDA CFR 21 ■ Maximum temperature: 230 °C (446 °F) ■ Order number: 60018911
---	---

-  Maximum process pressure for the weld-in adapters:
- 25 bar (362 PSI) at maximum 150 °C (302 °F)
 - 40 bar (580 PSI) at maximum 100 °C (212 °F)

 For more information on the weld-in adapters FTL20/31/33, FTL50, see the Technical Information (TI00426F/00).

Service-specific accessories

Accessories	Description
Applicator	<p>Software for selecting and sizing Endress+Hauser measuring devices:</p> <ul style="list-style-type: none"> ■ Calculation of all the necessary data for identifying the optimum measuring device: e.g. pressure loss, accuracy or process connections. ■ Graphic illustration of the calculation results <p>Administration, documentation and access to all project-related data and parameters over the entire life cycle of a project.</p> <p>Applicator is available:</p> <ul style="list-style-type: none"> ■ Via the Internet: https://portal.endress.com/webapp/applicator ■ On CD-ROM for local PC installation.
Configurator	<p>Product Configurator - the tool for individual product configuration</p> <ul style="list-style-type: none"> ■ Up-to-the-minute configuration data ■ Depending on the device: Direct input of measuring point-specific information such as measuring range or operating language ■ Automatic verification of exclusion criteria ■ Automatic creation of the order code and its breakdown in PDF or Excel output format ■ Ability to order directly in the Endress+Hauser Online Shop <p>The Configurator is available on the Endress+Hauser website: www.endress.com -> Click "Corporate" -> Select country -> Click "Products" -> Select the product using the filters and search field -> Open product page -> The "Configure" button to the right of the product image opens the Product Configurator.</p>
W@M	<p>Life cycle management for your plant</p> <p>W@M supports with a wide range of software applications over the entire process: from planning and procurement, to the installation, commissioning and operation of the measuring devices. All the relevant device information, such as the device status, spare parts and device-specific documentation, is available for every device over the entire life cycle.</p> <p>The application already contains the data of your Endress+Hauser device. Endress+Hauser also takes care of maintaining and updating the data records.</p> <p>W@M is available:</p> <ul style="list-style-type: none"> ■ Via the Internet: www.endress.com/lifecyclemanagement ■ On CD-ROM for local PC installation.

Documentation



Modular resistance thermometer for hygienic and aseptic applications iTHERM TM411:
TI01038T/09/EN



Insert iTHERM TS111: TI01014T/09/EN

www.addresses.endress.com
