

Brief Operating Instructions Fieldgate FXA42

System Products



These Instructions are Brief Operating Instructions; they are not a substitute for the Operating Instructions pertaining to the device.

Detailed information about the device can be found in the Operating Instructions and the other documentation:
Available for all device versions via:

- Internet: www.endress.com/deviceviewer
- Smart phone/tablet: *Endress+Hauser Operations App*

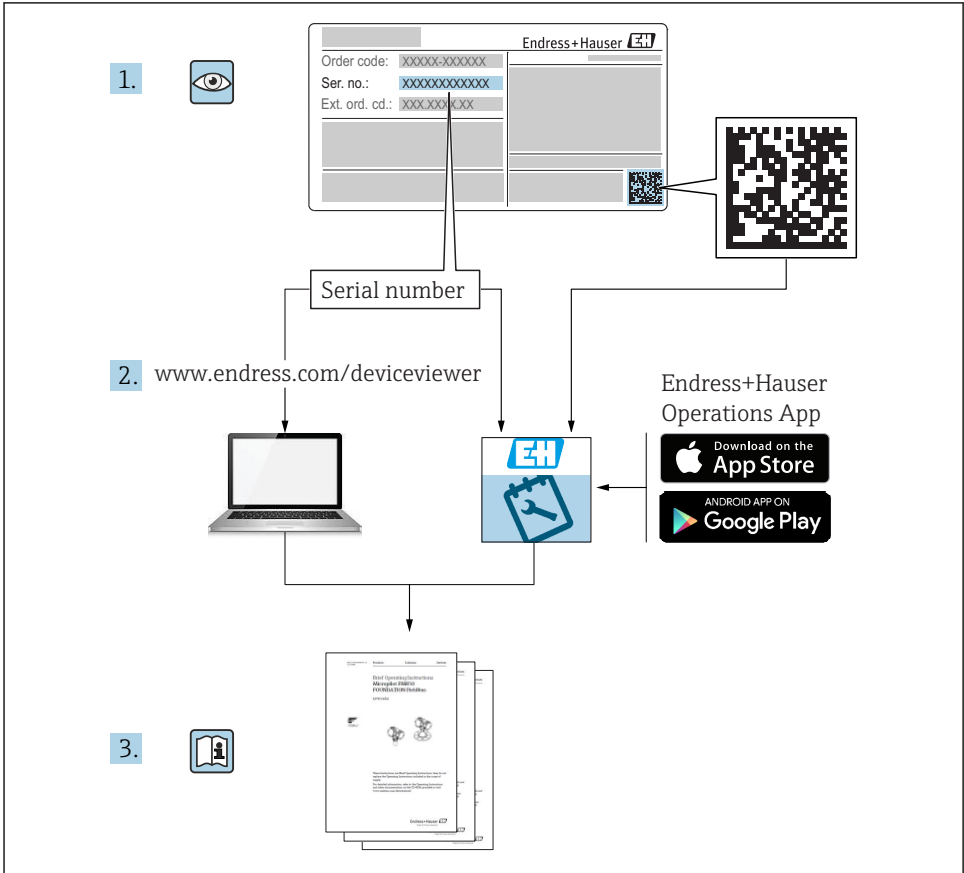

A0023555

Table of contents

1	About this document	3
1.1	Symbols	3
2	Basic safety instructions	4
2.1	Requirements for the personnel	4
2.2	Designated use	5
2.3	Workplace safety	5
2.4	Operational safety	5
2.5	Product safety	6
3	Product description	7
3.1	Product design	7
4	Incoming acceptance and product identification	8
4.1	Incoming acceptance	8
4.2	Product identification	8
4.3	Scope of delivery	9
4.4	Manufacturer address	9
5	Installation	9
5.1	Installation conditions	9
5.2	Dimensions	10
5.3	Mounting procedure	10
5.4	Antenna	11
5.5	Post-installation check	12
6	Electrical connection	12
6.1	Supply voltage	12
6.2	RS485 serial interface (Modbus)	12
6.3	Terminal assignment	13
7	Commissioning	15
7.1	Display elements (device status indicator / LED)	15
7.2	Preparatory steps	17
7.3	Establishing the data connection	17
7.4	Installing the latest firmware	20
7.5	Configuration examples	22

1 About this document

1.1 Symbols

1.1.1 Safety symbols



This symbol alerts you to a dangerous situation. Failure to avoid this situation will result in serious or fatal injury.



This symbol alerts you to a dangerous situation. Failure to avoid this situation can result in serious or fatal injury.

⚠ CAUTION

This symbol alerts you to a dangerous situation. Failure to avoid this situation can result in minor or medium injury.

NOTICE

This symbol contains information on procedures and other facts which do not result in personal injury.

1.1.2 Electrical symbols

 Ground connection

Grounded clamp, which is grounded via a grounding system.

 Signal ground connection

A terminal that can be used as a ground contact for the digital input.

1.1.3 Communication symbols

 Wireless Local Area Network (WLAN)

Communication via a wireless, local network

 Light emitting diode is off

 Light emitting diode is on

 Light emitting diode is flashing

1.1.4 Symbols for certain types of information

 Tip

Indicates additional information

 Reference to documentation

 Reference to another section

 1, 2, 3 Series of steps

1.1.5 Symbols in graphics

1, 2, 3 ... Item numbers

 Hazardous area

 Safe area (non-hazardous area)

2 Basic safety instructions

2.1 Requirements for the personnel

The personnel must fulfill the following requirements to carry out the necessary tasks, e. g., commissioning and maintenance:

- ▶ Trained, qualified specialists must have a relevant qualification for the specific function and task
- ▶ Are authorized by the plant owner/operator

- ▶ Are familiar with federal/national regulations
- ▶ Must have read and understood the instructions in the manual and supplementary documentation
- ▶ Follow instructions and comply with conditions

2.2 Designated use

2.2.1 Application

Fieldgates make it possible to remotely interrogate connected 4 to 20 mA, Modbus RS485 and Modbus TCP devices, either via Ethernet TCP/IP, WLAN or mobile telecommunications (UMTS, LTE Cat M1 and Cat NB1). The measured data are processed accordingly and forwarded to SupplyCare. In SupplyCare, the data are visualized, compiled into reports and used for other inventory management tasks. However, it is also possible to access the data transmitted by Fieldgate FXA42 without any additional software using the Web browser. Comprehensive configuration and automation capabilities are available for the Fieldgate FXA42 thanks to the integrated Web PLC.

2.2.2 Incorrect use

The manufacturer is not liable for damage caused by improper or non-designated use.

Verification for borderline cases:

- ▶ For special fluids and fluids for cleaning, Endress+Hauser is glad to provide assistance in verifying the corrosion resistance of process-wetted materials, but does not accept any warranty or liability.

2.2.3 Residual risks

When in operation, the housing may reach a temperature close to the process temperature.

Danger of burns from contact with surfaces!

- ▶ For elevated process temperatures, ensure protection against contact to prevent burns.

2.3 Workplace safety

For work on and with the device:

- ▶ Wear the required personal protective equipment according to federal/national regulations.
- ▶ Switch off the supply voltage before connecting the device.

2.4 Operational safety

Risk of injury!

- ▶ Operate the device in proper technical condition and fail-safe condition only.
- ▶ The operator is responsible for interference-free operation of the device.

Conversions to the device

Unauthorized modifications to the device are not permitted and can lead to unforeseeable dangers.

- ▶ If, despite this, modifications are required, consult with Endress+Hauser.

Hazardous area

To eliminate a danger for persons or for the facility when the device is used in the hazardous area (e.g. explosion protection, pressure vessel safety):

- ▶ Based on the nameplate, check whether the ordered device is permitted for the intended use in the hazardous area.
- ▶ Observe the instructions in the separate supplementary documentation. The separate supplementary documentation is an integral part of these Operating Instructions and can be in the form of an XA or SD document, for example.

2.5 Product safety

This device is designed in accordance with good engineering practice to meet state-of-the-art safety requirements, has been tested, and left the factory in a condition in which it is safe to operate.

It meets general safety standards and legal requirements. It also complies with the EU directives listed in the device-specific EU Declaration of Conformity. Endress+Hauser confirms this by affixing the CE mark to the device.

3 Product description

3.1 Product design

Four versions of the Fieldgate FXA42 are available. These versions differ in terms of the device features and data transmission technology.

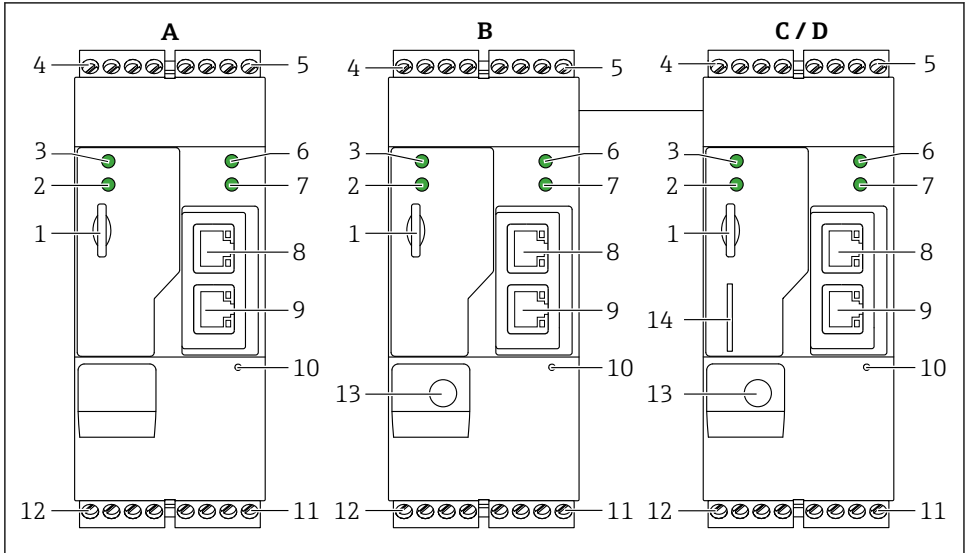

A0030516

1 Fieldgate FXA42 versions and design

A FXA42-A Ethernet

B FXA42-B Ethernet and WLAN

C FXA42-C Ethernet and 2G/3G

D FXA42-D Ethernet and LTE Cat M1 and Cat NB1 (2G/4G)

1 Slot for memory card, card type: microSD

2 Status LED for modem / WLAN / Ethernet

3 Status LED for supply voltage

4, 5 Input modules with analog input, digital input, current source and reference potential → 13

6 Status LED for network

7 Status LED for Web PLC

8, 9 Ethernet connections

10 Reset button

11 Power supply for Fieldgate FXA42, power supply for digital outputs, digital outputs → 13

12 RS-485 serial interface → 13

13 Connection for antenna (only WLAN and mobile telecommunications versions)

14 Slot for SIM card (only mobile telecommunications versions)

4 Incoming acceptance and product identification

4.1 Incoming acceptance

Check the following during incoming acceptance:

- Are the order codes on the delivery note and the product sticker identical?
- Are the goods undamaged?
- Do the nameplate data match the ordering information on the delivery note?



If one of these conditions is not met, please contact the manufacturer's sales office.

4.2 Product identification

The following options are available for identifying the gateway:

- Nameplate specifications
- Order code with breakdown of the device features on the delivery note
- Enter the serial number on the nameplate into *W@M Device Viewer* (www.endress.com/deviceviewer): all the information about the gateway is displayed.
- Enter the serial number on the nameplate into the *Endress+Hauser Operations App* or scan the 2-D matrix code (QR code) on the nameplate with the *Endress+Hauser Operations App*: all the information about the gateway is displayed.

4.2.1 Nameplate

The diagram shows a rectangular nameplate for an Endress+Hauser device. At the top right is the logo 'Endress+Hauser' with a stylized 'EH' symbol and 'IP20' below it. On the left side, there are several circular icons with different symbols inside. The main area contains the following fields and labels:

- Order code: [text box]
- Ser. no.: [text box]
- LAN1/2: [text box]
- MAC: [text box]
- Ta: [text box]
- Dat.: [text box]

There are also three small square boxes at the bottom left and one at the bottom right.

A0030895

- 1 Order code
- 2 Serial number

4.3 Scope of delivery

- Fieldgate FXA42 for DIN rail mounting
- SD card (card type: microSD), 1 GB
- Hard copy of Brief Operating Instructions



For detailed information on "Accessories", see the Operating Instructions.

4.4 Manufacturer address

Endress+Hauser SE+Co. KG

Hauptstraße 1

79689 Maulburg, Germany

Address of the manufacturing plant: See nameplate.

5 Installation

5.1 Installation conditions

5.1.1 Temperature and humidity

Normal operation (EN 60068-2-14; Nb; 0.5 K/min): -20 to 60 °C (-4 to 140 °F)

Side by side installation: -20 to 50 °C (-4 to 122 °F)

Avoid condensation.

Humidity (EN 60068-2-30; Db; 0.5 K/min): 5 to 85%; non-condensing

5.1.2 Orientation

Vertical or horizontal on DIN rail (HT 35 as per EN 60715).

5.2 Dimensions

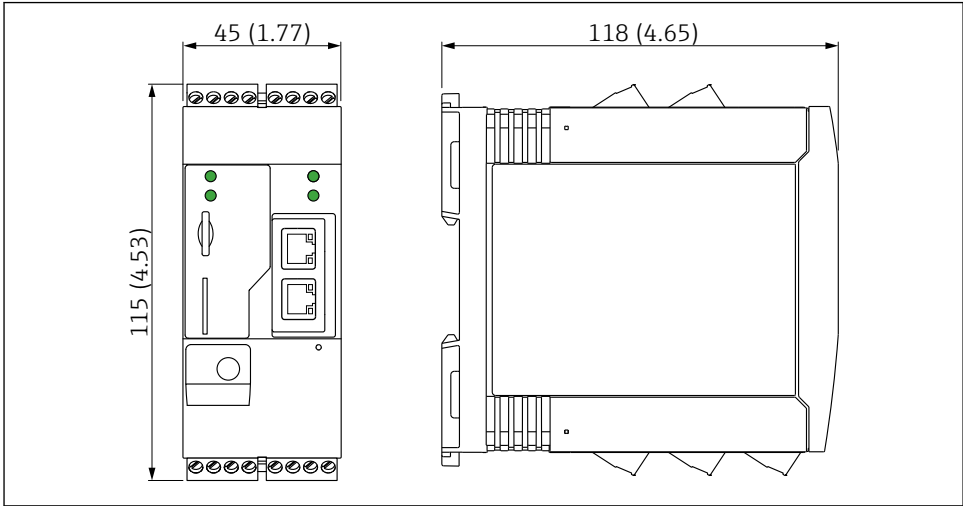

A0030517

2 Dimensions in mm (in)

5.3 Mounting procedure

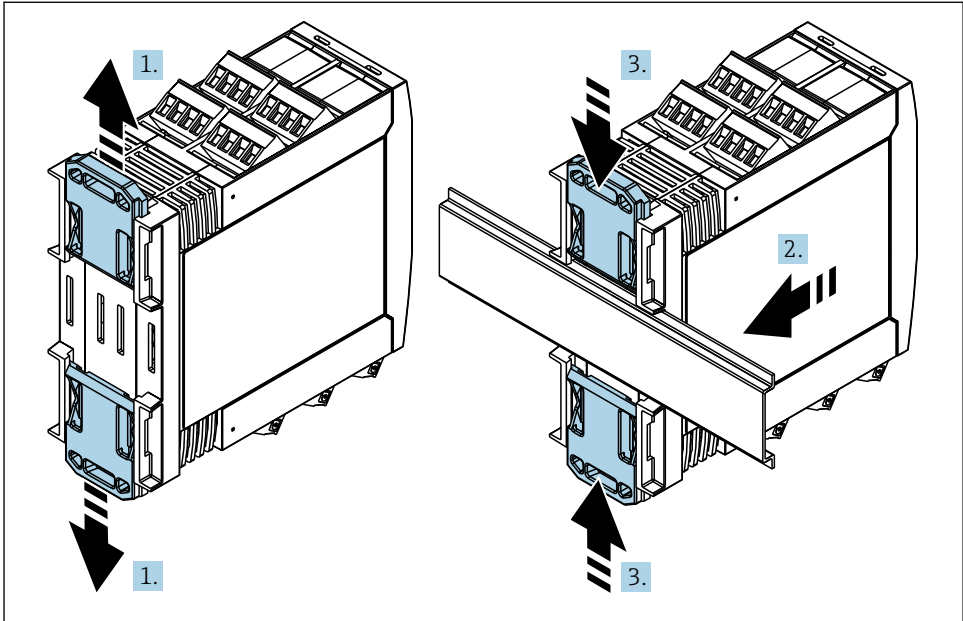

A0011766

1. Slide the upper DIN rail clip upwards and the lower clip downwards until they click into place.
2. Fit the device on the DIN rail from the front.
3. Slide the two DIN rail clips back together until they click into place.

To disassemble the device, push the DIN rail clips up or down (see 1.) and remove the device from the rail. It also suffices to open just one of the DIN rail clips and then tilt the device to remove it from the rail.

5.4 Antenna

The devices require an external antenna for wireless communication via UMTS (2G/3G), LTE Cat M1 and Cat NB1 (2G/4G) and WLAN. The antenna can be purchased as an accessory from Endress+Hauser. The antenna cable is screwed onto the connection on the front of the device. The antenna must be mounted outside the cabinet or field housing. In areas with weak reception, it is advisable to first check the communication before securing the antenna permanently.

Connection: SMA connection.

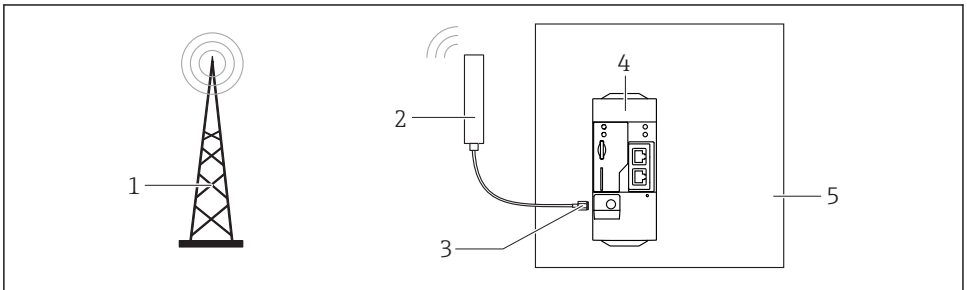

A0031111

- 1 Mobile communications networks
- 2 Antenna for Fieldgate FXA42
- 3 SMA connection
- 4 Fieldgate FXA42 Ethernet and 2G/3G/4G
- 5 Control cabinet

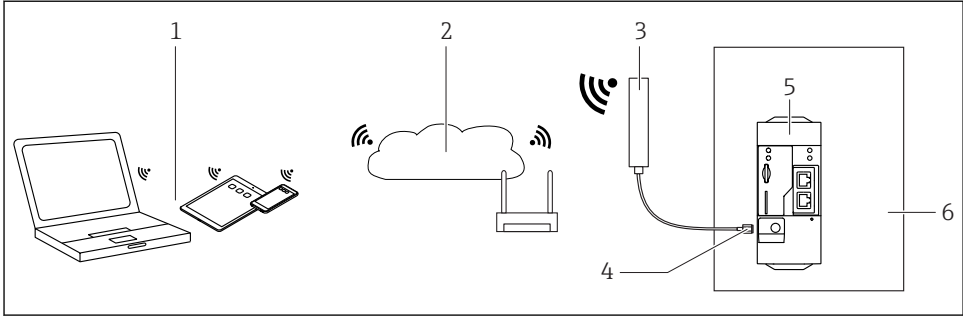

A0031112

- 1 WLAN receivers
- 2 Uplink to Internet or LAN via router
- 3 Antenna for Fieldgate FXA42
- 4 SMA connection
- 5 Fieldgate FXA42 Ethernet and WLAN
- 6 Control cabinet

5.5 Post-installation check

- Is the DIN rail clip clicked into place?
- Is the device securely seated on the DIN rail?
- Are all plug-in terminals securely engaged?
- Are the temperature limits observed at the mounting location?

6 Electrical connection

⚠ WARNING

Danger! Electric voltage!

Risk of electric shock and injury from startle response.

- ▶ De-energize all power sources before connecting.
- ▶ Before commissioning the device, measure the supply voltage and compare it with the voltage specifications on the nameplate. Only connect the device if the supply voltage measured matches the specifications.

6.1 Supply voltage

The supply voltage is $24 V_{DC}$ ($\pm 20\%$). You may only use power units that ensure safe electrical isolation according to DIN VDE 0570-2-6 and EN61558-2-6 (SELV / PELV or NEC Class 2) and that are designed as limited-energy circuits.

6.2 RS485 serial interface (Modbus)

Internal resistance: 96 k Ω

Protocol: Modbus RTU



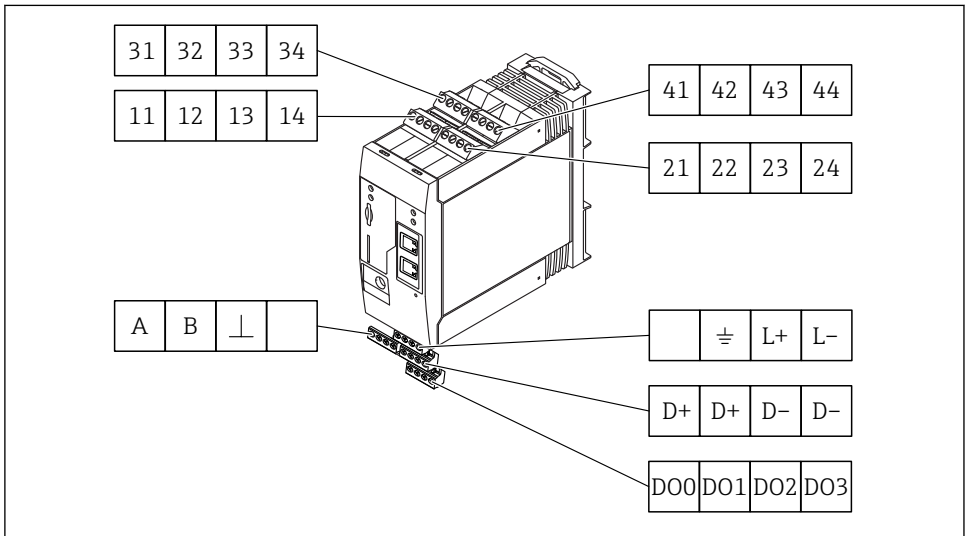

External termination required (120 Ω)

6.3 Terminal assignment



A0030525

Terminal assignment of input modules				Properties	Function
11	21	31	41		GND
12	22	32	42	Input voltage L: < 5 V Input voltage H: > 11 V Input current: < 5 mA Maximum input voltage: 35 V	Digital input
13	23	33	43	Maximum input voltage: 35 V Maximum input current: 22 mA Internal resistance: 250 Ω (suitable for HART communication)	Analog input 4 to 20 mA
14	24	34	44	Output voltage: 28 V _{DC} (no-load) 26 V _{DC} @ 3 mA 20 V _{DC} @ 30 mA Output current: max. 160 mA The auxiliary voltage is short-circuit proof, galvanically isolated and non-stabilized.	Auxiliary voltage output The auxiliary voltage output can be used for loop power supply or to control the digital inputs.

Terminal assignment		Properties	Terminal assignment		Properties	
DO0 DO1 DO2 DO3	DO0	High-side driver, sourcing, DC-PNP. Output current: 500 mA	D+ D+ D- D-	D+	12 to 24 V _{DC}	
	DO1			D+	12 to 24 V _{DC}	
	DO2			D-	GND	
	DO3			D-	GND	
A B 	A	Signal	 L+ L-	Not assigned		
	B	Signal			Ground connection	
		Ground / optional shield connection			L+	24 V _{DC}
		Not assigned		L-	GND	

- 1) You may only use power units that ensure safe electrical isolation according to DIN VDE 0570-2-6 and EN61558-2-6 (SELV / PELV or NEC Class 2) and that are designed as limited-energy circuits.

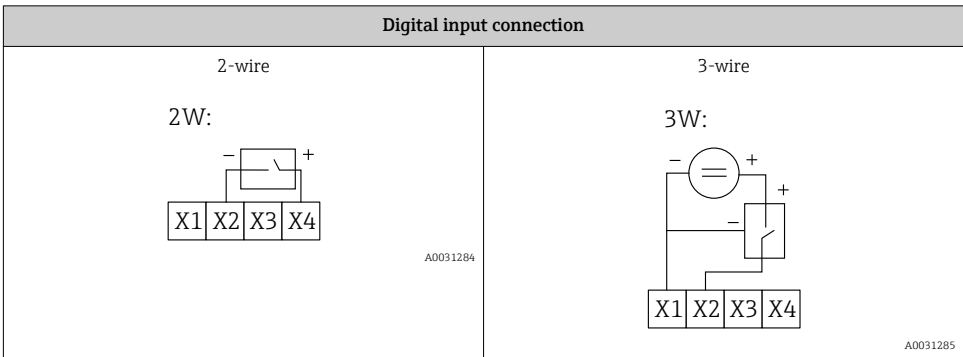
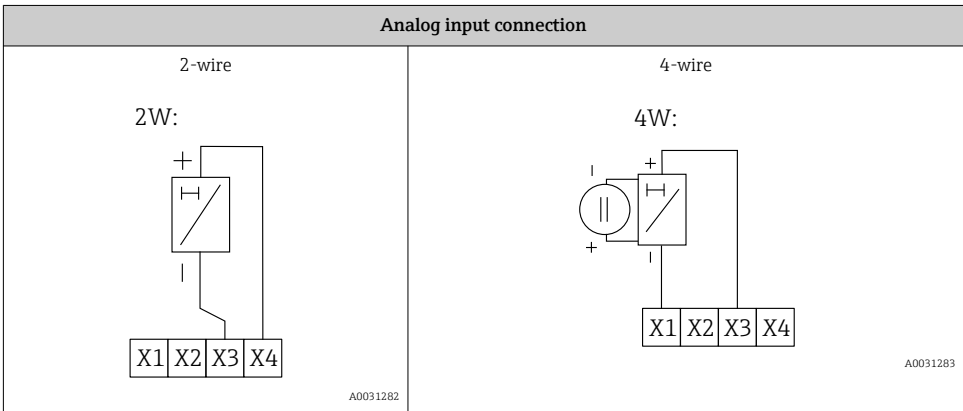

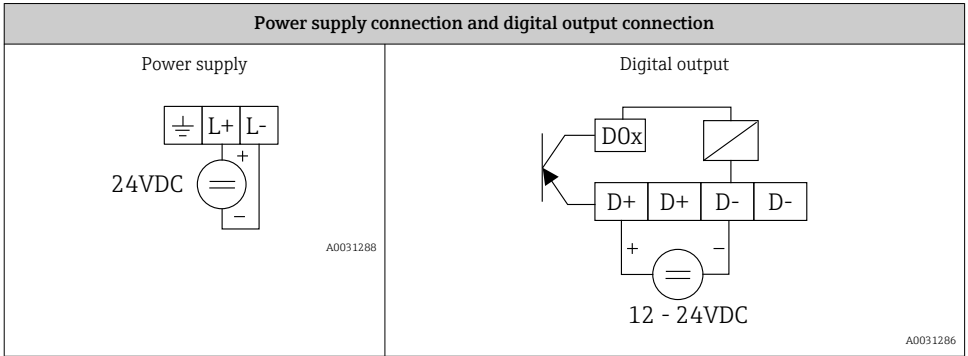





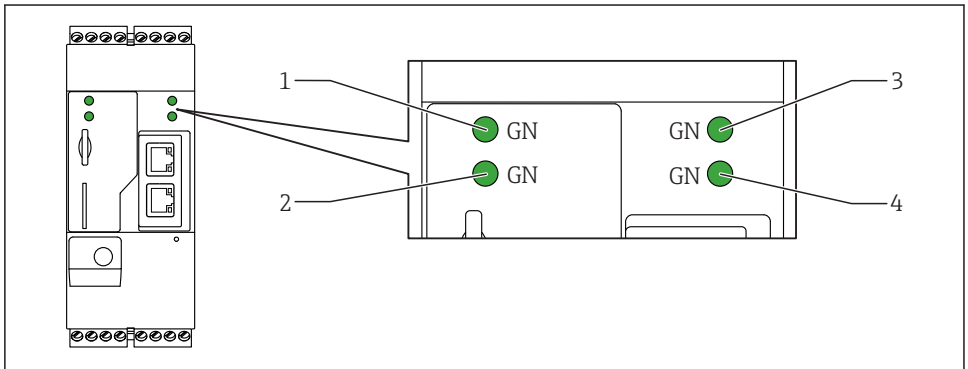

7 Commissioning

7.1 Display elements (device status indicator / LED)



- 1 Power
- 2 Modem (mobile communications versions) / WLAN / Ethernet
- 3 Network
- 4 Web-PLC

Identifier	State	Color	Meaning	Comment
Power		Green (GN)	Power supply ON	
Modem		Green (GN)	Power supply for modem ON	Only mobile communications versions
WLAN		Green (GN)	Power supply for WLAN module ON	Only WLAN version

Identifier	State	Color	Meaning	Comment
Ethernet		Green (GN)	Power supply for Ethernet interface ON	Only Ethernet version
Network		Green (GN)	Data connection established	Ethernet version: valid fixed IP address configured or DHCP completed successfully
Network			Data connection interrupted	Ethernet version: no valid fixed IP address configured or DHCP not completed successfully
Web-PLC		Green (GN)	Editor program for Web-PLC is enabled	
	2 x 	Green (GN)	Manual firmware update completed successfully	
	2 x 	Green (GN)	Reset to factory settings (factory reset) confirmed	

7.2 Preparatory steps

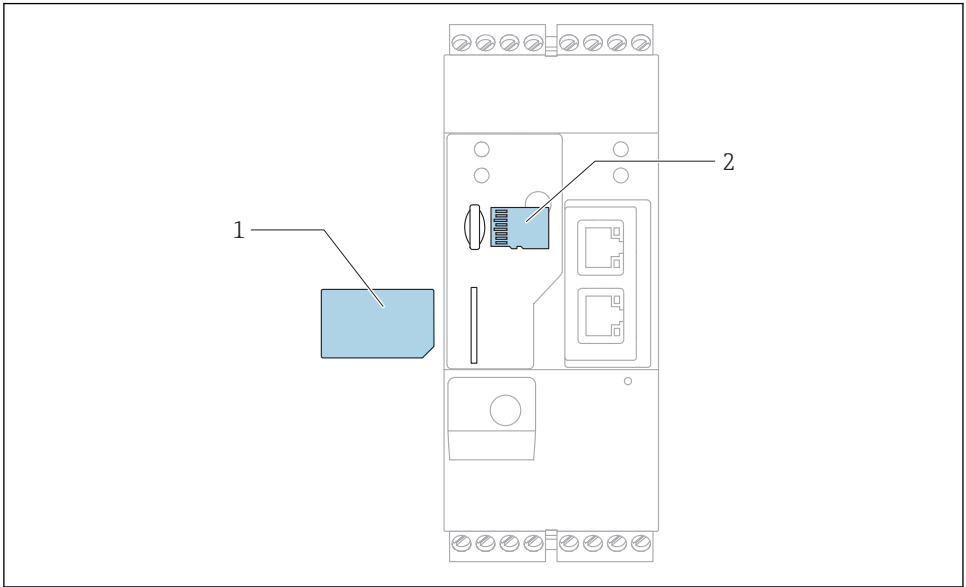

A0030897

- 1 SIM card
- 2 SD card (microSD)



The SD card is already installed and formatted on delivery.

1. Check that the gateway is securely seated on the DIN rail and that the cable connections are correctly secured at the terminals and the antenna.
2. Mobile communications versions: insert the SIM card.
3. Switch on supply voltage.

7.3 Establishing the data connection

Default settings for the data connection:

- IP address: **http://192.168.252.1**
- User name for the administrator: **super**
- Password for the administrator: **super**
- Users who do not wish to configure the Fieldgate FXA42 or who do not have the necessary authorization can log on with the following default login data. User name: **eh**; password: **eh**

1. Connect the device directly to a PC or laptop using an Ethernet cable.

2. Assign the computer an IP address that is in the same subnet as the device itself. Therefore, select the IP address so that it is similar to, but not identical to, the preconfigured IP address of the device. The IP address of the computer and that of the device may not be identical.
3. Microsoft Windows: Open the **Start** menu and select the **Control Panel** menu item.
4. Select the **Network Connections** menu item and select the Ethernet connection to which the device is connected.
- 5.

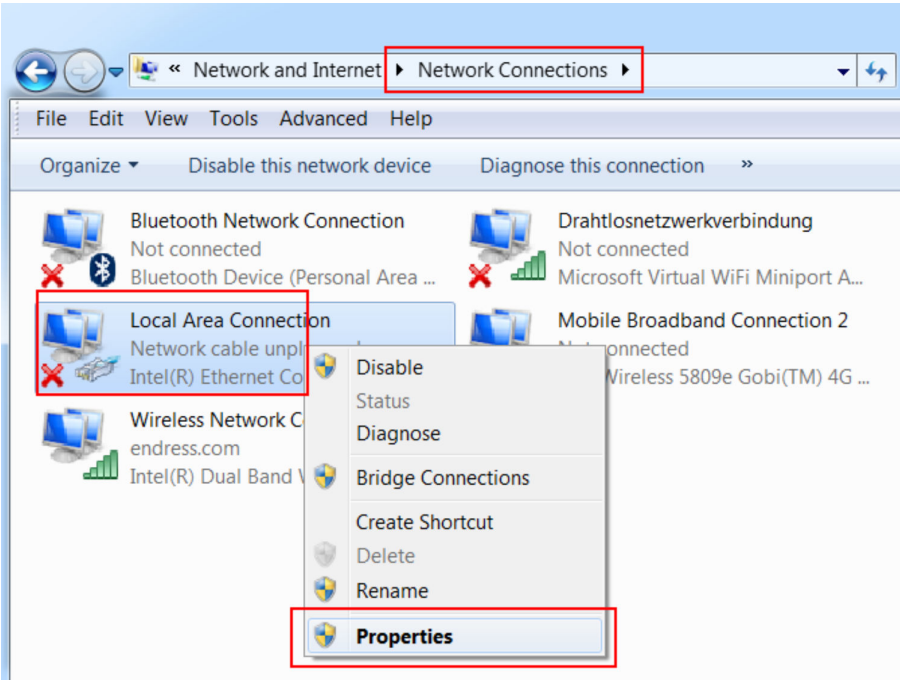

Right-click with the mouse button to open the context menu. Select the **Properties** menu item.

6.

Internet Protocol Version 4 (TCP/IPv4) Properties

General

You can get IP settings assigned automatically if your network supports this capability. Otherwise, you need to ask your network administrator for the appropriate IP settings.

Obtain an IP address automatically

Use the following IP address:

IP address: 192 . 168 . 252 . 5

Subnet mask: 255 . 255 . 255 . 0

Default gateway: . . .

Obtain DNS server address automatically

Use the following DNS server addresses

Preferred DNS server: . . .

Alternate DNS server: . . .

Validate settings upon exit

Advanced...

OK Cancel

Select the **Use the Following IP Address** option and enter an IP address. Example of an IP address: 192.168.252.2

7. **Subnet mask:** enter 255.255.255.0 and press **OK** to confirm your entry.

8. Open an Internet browser and enter the preconfigured IP address 192.168.252.1 in the address line of the browser.

9. Enter the user name and password. Press **OK** to confirm your entry.

↳ The connection is now established and the Fieldgate FXA42 welcome screen is displayed.

The display changes automatically after a few seconds and the home screen to access the configuration menus appears.

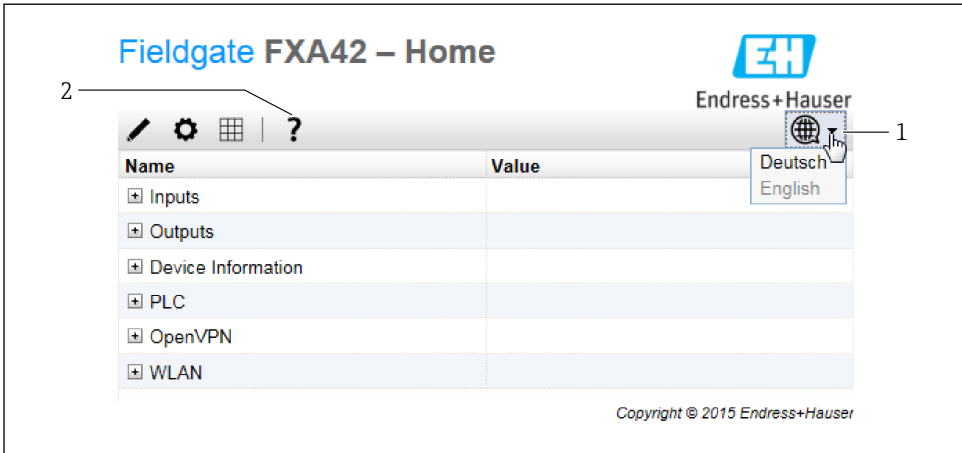

A0030547

- 1 Select the Language menu
- 2 Help

To change the language of the user interface, open the menu (1) in the top right-hand corner of the startup screen and select a language.

To open the Help function, click the question mark icon (2). The home page and the icons in the tool bar are explained in the Help function.

The home page gives a logged-in administrator access to the functions and settings of the device, the device's inputs and outputs and its properties.

 For detailed information on "Commissioning" and "Configuration", see the Operating Instructions.

7.4 Installing the latest firmware

Due to storage and transportation times, the latest firmware version might not be installed on your Fieldgate FXA42. It is therefore advisable to update the firmware when the device is put into operation.

 For detailed information on "Updating", see the Operating Instructions.

7.4.1 Updating the firmware manually

Preconditions for a manual update:

- The device is connected to a stable power supply.
- The SD card has been formatted by the Fieldgate FXA42.
- The latest firmware has already been downloaded or can be downloaded via an Internet connection.

Click the following link to download the latest firmware:

https://weupcmasafgfirmware.blob.core.windows.net/fxa42/fxa42_current.cup



The SD card included in the delivery is already formatted.

NOTICE

A complete device failure can occur if a live update process is interrupted.

If this happens, the device then does not transmit any more data and can no longer be configured.

- ▶ Pay attention to the warning information on the **Update** screen of the Fieldgate FXA42 user interface.
- ▶ Once the update has started, make sure to wait until it has finished. This can take a few minutes. Once the update is finished, the device is automatically restarted and the home page of the Fieldgate FXA42 is displayed in the Web browser.
- ▶ Ensure that the power supply to the device is not disconnected during the update process.

Manual update with Web GUI



Comply with the conditions for a manual update specified at the start of this chapter.

1. Open a Web browser and log into the Web GUI of the Fieldgate FXA42.
2. Open the **Settings** page.
3. Open the **Update** page. Pay attention to the warning on the page that opens.
4. Click the **Browse...** button in the **Manual update** section.
 - ↳ A dialog box opens where you can select the update file.
5. Select the update package.
6. To start the update, click the **Start update** button.
 - ↳ Once the update has started, make sure to wait until it has finished. This can take a few minutes.

Once the update is finished, the device is automatically restarted and the home page of the Fieldgate FXA42 is displayed in the Web browser.

Manual update with SD card

If there is no data connection to the Fieldgate FXA42, the user can also copy the current firmware to the SD card using the PC.

 Comply with the conditions for a manual update specified at the start of this chapter.

 The SD card included in the delivery is already formatted.

1. Download the current version of the firmware (update package (*.cup)) and save it.
2. Insert the SD card formatted by the Fieldgate FXA42 into a card reader or into a suitable interface on the PC.
3. Open a file management program (e.g. Explorer) and write the update package to the SD card. File path: b:\FXA42\update.cup
4. Insert the SD card into the slot provided on the device.
5. Using a suitable tool (e.g. a piece of wire), press the reset button until the **Web-PLC** LED flashes twice.
 - ↳ Once the update has started, make sure to wait until it has finished. This can take a few minutes.

When the update is finished, the device reboots automatically.

7.5 Configuration examples

 For detailed information on the "Configuration", see the Operating Instructions.



71457307

www.addresses.endress.com
