

Operating Instructions

Cerabar PMP23

IO-Link

Process pressure measurement
Pressure transducer for safe measurement and
monitoring of absolute and gauge pressure

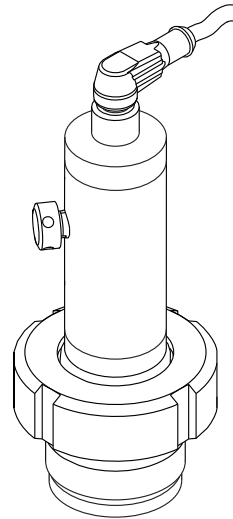
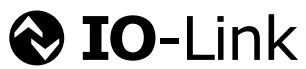

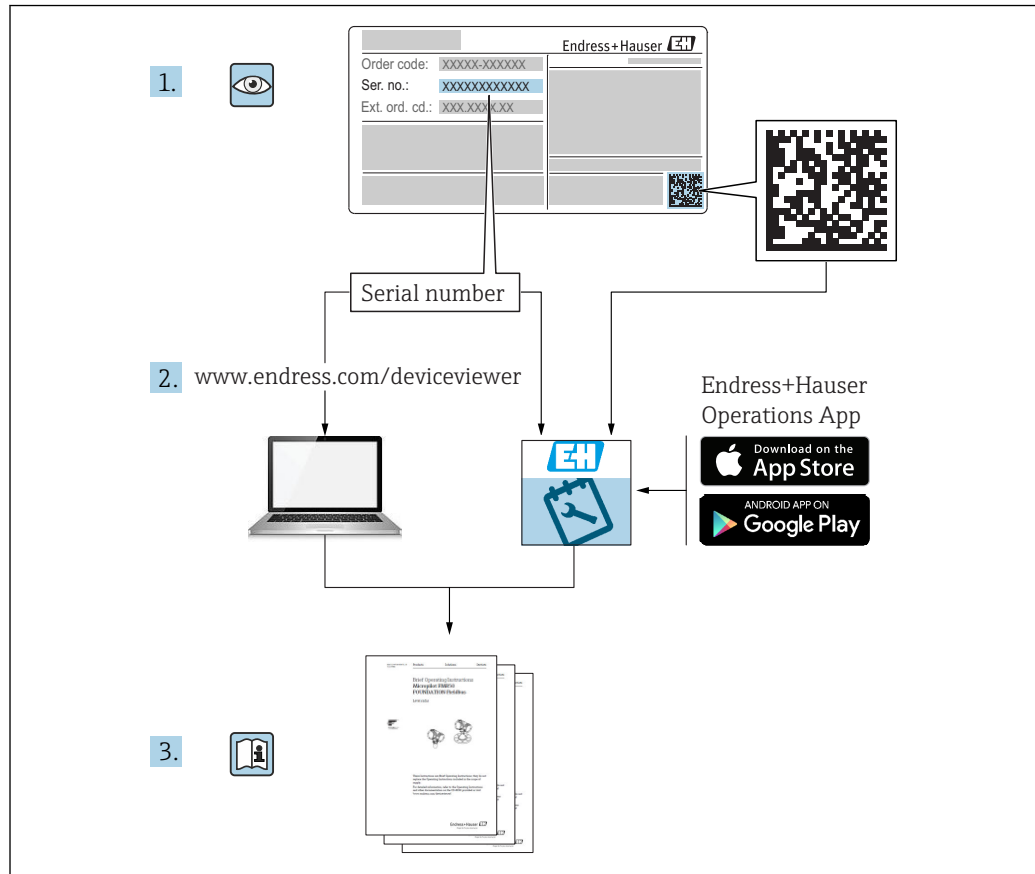

A0023555

- Make sure the document is stored in a safe place such that it is always available when working on or with the device.
- To avoid danger to individuals or the facility, read the "Basic safety instructions" section carefully, as well as all other safety instructions in the document that are specific to working procedures.
- The manufacturer reserves the right to modify technical data without prior notice. Your Endress+Hauser distributor will supply you with current information and updates to these Operating Instructions.

Table of contents

1	About this document	4	9	Commissioning	24
1.1	Document function	4	9.1	Function check	24
1.2	Symbols used	4	9.2	Commissioning with an operating menu	24
1.3	Documentation	5	9.3	Configuring pressure measurement	25
1.4	Terms and abbreviations	6	9.4	Performing position adjustment	27
1.5	Turn down calculation	7	9.5	Configuring process monitoring	29
1.6	Registered trademarks	7	9.6	Current output	33
			9.7	Application examples	36
2	Basic safety instructions	8	10	Diagnostics and troubleshooting ...	37
2.1	Requirements concerning the staff	8	10.1	Troubleshooting	37
2.2	Designated use	8	10.2	Diagnostic events	38
2.3	Workplace safety	9	10.3	Behavior of the device in the event of a fault ..	40
2.4	Operational safety	9	10.4	Behavior of current output in the event of a fault	40
2.5	Product safety	9	10.5	Resetting to factory settings (reset)	41
3	Product description	10	11	Maintenance	41
3.1	Product design	10	11.1	Exterior cleaning	41
3.2	Function	10	12	Repairs	42
4	Incoming acceptance and product identification	11	12.1	General notes	42
4.1	Incoming acceptance	11	12.2	Return	42
4.2	Product identification	12	12.3	Disposal	42
4.3	Storage and transport	12	13	Overview of the operating menu ...	43
5	Installation	14	14	Description of device parameters ...	44
5.1	Mounting dimensions	14	14.1	Identification	44
5.2	Installation conditions	14	14.2	Diagnostics	44
5.3	Influence of the installation position	14	14.3	Parameters	46
5.4	Mounting location	15	14.4	Observation	57
5.5	Mounting of the profile seal for universal process mounting adapter	16	15	Accessories	58
5.6	Post-installation check	16	15.1	Weld-in adapter	58
6	Electrical connection	17	15.2	Process adapter M24	58
6.1	Connecting the measuring unit	17	15.3	M12 plug connectors	59
6.2	Switching capacity	18	16	Technical data	60
6.3	Connection data	18	16.1	Input	60
6.4	Post-connection check	18	16.2	Output	62
7	Operation options	20	16.3	Performance characteristics of metal process isolating diaphragm	64
7.1	Operation with an operating menu	20	16.4	Environment	66
8	System integration	21	16.5	Process	67
8.1	Process data	21	Index	68	
8.2	Reading out and writing device data (ISDU – Indexed Service Data Unit)	21			





1 About this document

1.1 Document function



These Operating Instructions contain all the information that is required in various phases of the life cycle of the device: from product identification, incoming acceptance and storage, to mounting, connection, operation and commissioning through to troubleshooting, maintenance and disposal.

1.2 Symbols used

1.2.1 Safety symbols

Symbol	Meaning
	DANGER! This symbol alerts you to a dangerous situation. Failure to avoid this situation will result in serious or fatal injury.
	WARNING! This symbol alerts you to a dangerous situation. Failure to avoid this situation can result in serious or fatal injury.
	CAUTION! This symbol alerts you to a dangerous situation. Failure to avoid this situation can result in minor or medium injury.
	NOTICE! This symbol contains information on procedures and other facts which do not result in personal injury.



1.2.2 Electrical symbols







Symbol	Meaning	Symbol	Meaning
	Protective ground connection A terminal which must be connected to ground prior to establishing any other connections.		Ground connection A grounded terminal which, as far as the operator is concerned, is grounded via a grounding system.

1.2.3 Tool symbols

Symbol	Meaning
 A0011222	Open-ended wrench

1.2.4 Symbols for certain types of information

Symbol	Meaning
	Permitted Procedures, processes or actions that are permitted.
	Forbidden Procedures, processes or actions that are forbidden.
	Tip Indicates additional information.

Symbol	Meaning
	Reference to documentation
	Reference to page
	Reference to graphic
	Series of steps
	Result of a step
	Visual inspection

1.2.5 Symbols in graphics

Symbol	Meaning
1, 2, 3 ...	Item numbers
	Series of steps
A, B, C, ...	Views

1.3 Documentation

 The document types listed are available:
 In the Download Area of the Endress+Hauser Internet site: www.endress.com → Download

1.3.1 Technical Information (TI): planning aid for your device

TI01203P

The document contains all the technical data on the device and provides an overview of the accessories and other products that can be ordered for the device.

1.3.2 Brief Operating Instructions (KA): getting the 1st measured value quickly

KA01164P

These instructions contain all the essential information from incoming acceptance to initial commissioning.

1.4 Terms and abbreviations

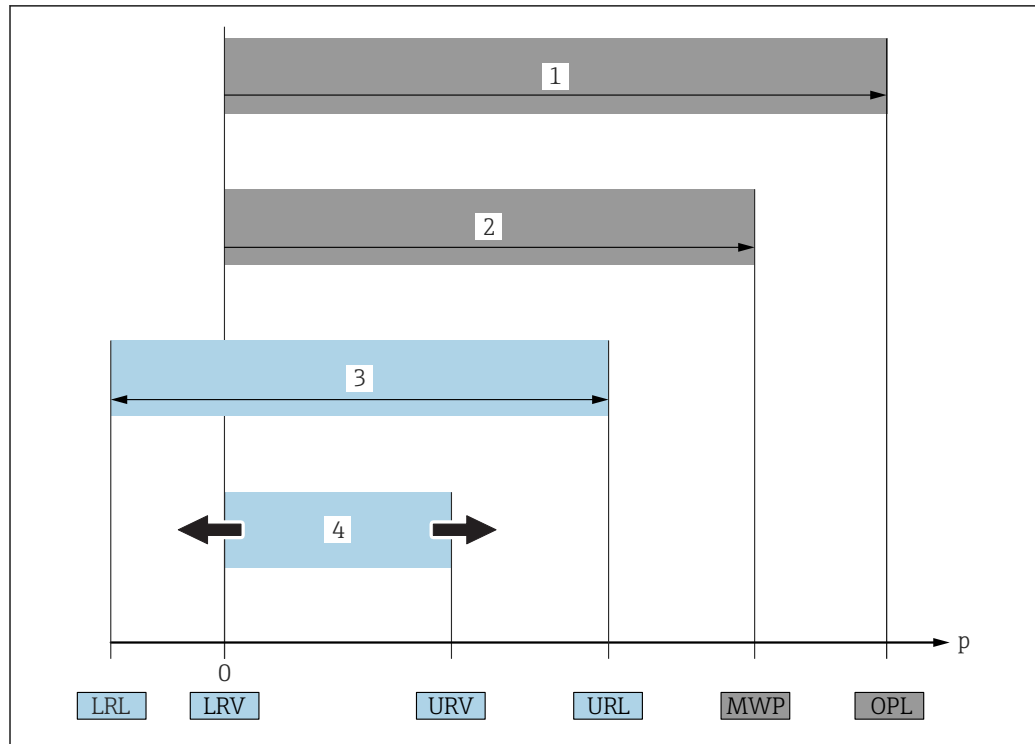

A0029505

Item	Term/ abbreviation	Explanation
1	OPL	The OPL (over pressure limit = sensor overload limit) for the measuring device depends on the lowest-rated element, with regard to pressure, of the selected components, i.e. the process connection has to be taken into consideration in addition to the measuring cell. Also observe pressure-temperature dependency. For the relevant standards and additional notes, see the "Pressure specifications" section → 67 . The OPL may only be applied for a limited period of time.
2	MWP	The MWP (maximum working pressure) for the sensors depends on the lowest-rated element, with regard to pressure, of the selected components, i.e. the process connection has to be taken into consideration in addition to the measuring cell. Also observe pressure-temperature dependency. For the relevant standards and additional notes, see the "Pressure specifications" section → 67 . The MWP may be applied at the device for an unlimited period. The MWP can also be found on the nameplate.
3	Maximum sensor measuring range	Span between LRL and URL This sensor measuring range is equivalent to the maximum calibratable/adjustable span.
4	Calibrated/ adjusted span	Span between LRV and URV Factory setting: 0 to URL Other calibrated spans can be ordered as customized spans.
p	-	Pressure
-	LRL	Lower range limit
-	URL	Upper range limit
-	LRV	Lower range value
-	URV	Upper range value
-	TD (turn down)	Turn down The turn down is preset at the factory and cannot be changed. Example - see the following section.

1.5 Turn down calculation

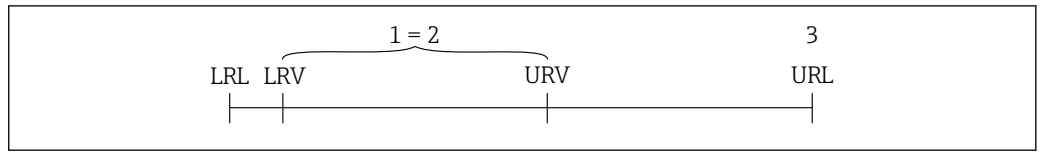

A0029545

- 1 *Calibrated/adjusted span*
- 2 *Zero point-based span*
- 3 *URL sensor*

Example

- Sensor: 10 bar (150 psi)
- Upper range value (URL) = 10 bar (150 psi)
- Lower range value (LRV) = 0 bar (0 psi)
- Calibrated/adjusted span: 0 to 5 bar (0 to 75 psi)
- Upper range value (URV) = 5 bar (75 psi)

Turn down (TD):

$$TD = \frac{URL}{|URV - LRV|}$$

$$TD = \frac{10 \text{ bar (150 psi)}}{|5 \text{ bar (75 psi)} - 0 \text{ bar (0 psi)}|} = 2$$

In this example, the TD is 2:1.
This span is based on the zero point.

1.6 Registered trademarks

 **IO-Link**

is a registered trademark of the IO-Link company group.

2 Basic safety instructions

2.1 Requirements concerning the staff

The personnel for installation, commissioning, diagnostics and maintenance must fulfill the following requirements:

- ▶ Trained, qualified specialists: must have a relevant qualification for this specific function and task
- ▶ Are authorized by the plant owner/operator
- ▶ Are familiar with federal/national regulations
- ▶ Before beginning work, the specialist staff must have read and understood the instructions in the Operating Instructions and supplementary documentation as well as in the certificates (depending on the application)
- ▶ Following instructions and basic conditions

The operating personnel must fulfill the following requirements:

- ▶ Being instructed and authorized according to the requirements of the task by the facility's owner-operator
- ▶ Following the instructions in these Operating Instructions

2.2 Designated use

2.2.1 Application and media

The Cerabar is used to measure absolute and gauge pressure in gases, vapors and liquids. The process-wetted materials of the measuring device must have an adequate level of resistance to the media.

The measuring device may be used for the following measurements (process variables)

- in compliance with the limit values specified under "Technical data"
- in compliance with the conditions that are listed in this manual.

Measured process variable

Gauge pressure or absolute pressure

Calculated process variable

Pressure

2.2.2 Incorrect use

The manufacturer is not liable for damage caused by improper or non-designated use.

Verification for borderline cases:

- ▶ For special fluids and fluids for cleaning, Endress+Hauser is glad to provide assistance in verifying the corrosion resistance of process-wetted materials, but does not accept any warranty or liability.

2.2.3 Residual risks

When in operation, the housing may reach a temperature close to the process temperature.

Danger of burns from contact with surfaces!

- ▶ For elevated process temperatures, ensure protection against contact to prevent burns.

2.3 Workplace safety

For work on and with the device:

- ▶ Wear the required personal protective equipment according to federal/national regulations.
- ▶ Switch off the supply voltage before connecting the device.

2.4 Operational safety

Risk of injury!

- ▶ Operate the device in proper technical condition and fail-safe condition only.
- ▶ The operator is responsible for interference-free operation of the device.

Conversions to the device

Unauthorized modifications to the device are not permitted and can lead to unforeseeable dangers.

- ▶ If, despite this, modifications are required, consult with Endress+Hauser.

Hazardous area

To eliminate the risk of danger to persons or the facility when the device is used in the approval-related area (e.g. pressure equipment safety):

- ▶ Check the nameplate to verify if the device ordered can be put to its intended use in the approval-related area.

2.5 Product safety

This measuring device is designed in accordance with good engineering practice to meet state-of-the-art safety requirements, has been tested, and left the factory in a condition in which it is safe to operate.

It meets general safety standards and legal requirements. It also complies with the EU directives listed in the device-specific EU Declaration of Conformity. Endress+Hauser confirms this by affixing the CE mark to the device.

3 Product description

3.1 Product design

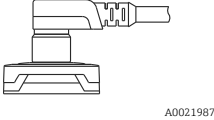
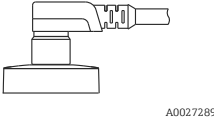
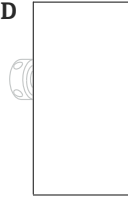
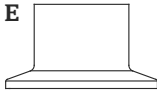
Overview		Item	Description
<div style="display: flex; justify-content: space-around;"> <div style="text-align: center;"> <p>C - 1</p>  <p>A0021987</p> </div> <div style="text-align: center;"> <p>C - 2</p>  <p>A0027289</p> </div> </div> <div style="margin-top: 20px;"> <p>D</p>  </div> <div style="margin-top: 20px;"> <p>E</p>  <p style="text-align: right; font-size: small;">A0027227</p> </div>	C - 1	M12 plug Housing cap made of plastic	
	C - 2	M12 plug IP69: metal housing cap	
	D E	Housing Process connection (sample illustration)	

3.2 Function

3.2.1 Calculating the pressure

Devices with metallic process isolating diaphragm

The process pressure deflects the metal process isolating diaphragm of the sensor and a fill fluid transfers the pressure to a Wheatstone bridge (semiconductor technology). The pressure-dependent change in the bridge output voltage is measured and evaluated.

4 Incoming acceptance and product identification

4.1 Incoming acceptance

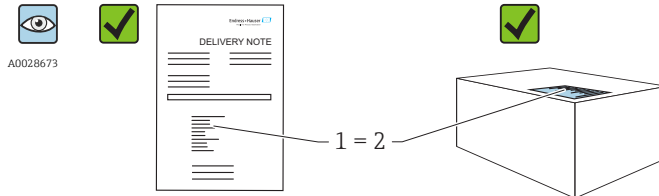

Is the order code on the delivery note (1) identical to the order code on the product sticker (2)?

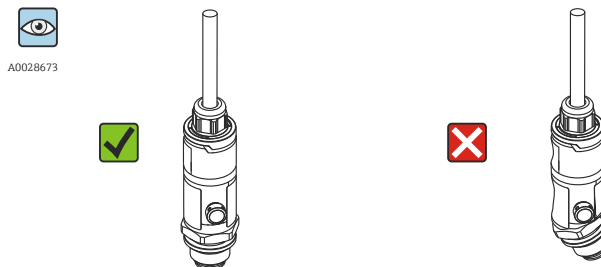
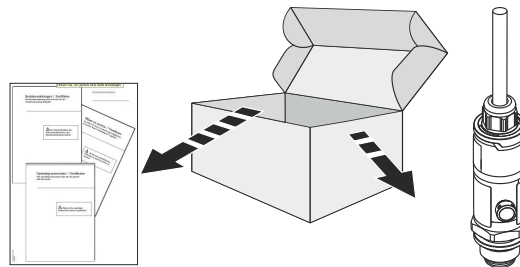

Are the goods undamaged?

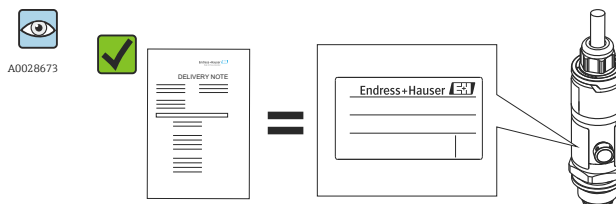

Do the data on the nameplate correspond to the order specifications and the delivery note?

i If one of these conditions does not apply, please contact your Endress+Hauser sales office.

4.2 Product identification

The following options are available for the identification of the measuring device:

- Nameplate specifications
- Order code with a breakdown of the device features on the delivery note
- Enter the serial numbers from the nameplates in *W@M Device Viewer* (www.endress.com/deviceviewer): All the information about the measuring device is displayed.

For an overview of the technical documentation provided, enter the serial number from the nameplates in *W@M Device Viewer* (www.endress.com/deviceviewer)

4.2.1 Manufacturer address

Endress+Hauser SE+Co. KG
Hauptstraße 1
79689 Maulburg, Germany

Address of the manufacturing plant: See nameplate.

4.2.2 Nameplate

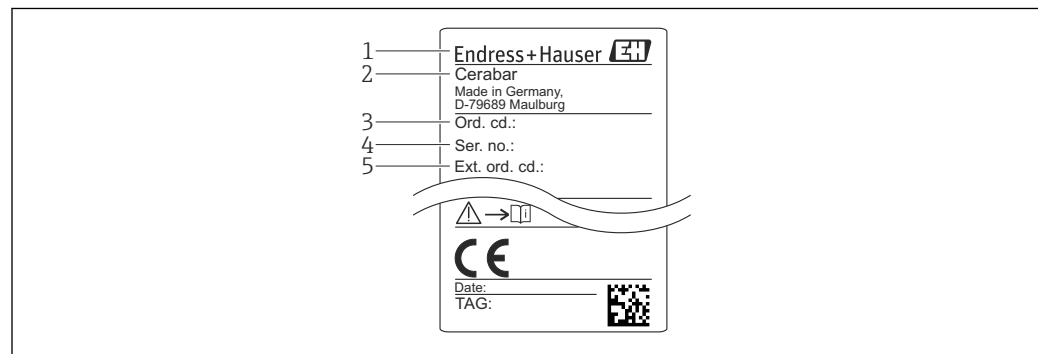

- 1 *Manufacturer's address*
- 2 *Device name*
- 3 *Order number*
- 4 *Serial number*
- 5 *Extended order number*

4.3 Storage and transport

4.3.1 Storage conditions

Use original packaging.

Store the measuring device in clean and dry conditions and protect from damage caused by shocks (EN 837-2).

Storage temperature range

-40 to +85 °C (-40 to +185 °F)

4.3.2 Transporting the product to the measuring point

⚠ WARNING**Incorrect transport!**

Housing and diaphragm may become damaged, and there is a risk of injury!

- ▶ Transport the measuring device to the measuring point in its original packaging or by the process connection.

5 Installation

5.1 Mounting dimensions

For dimensions, see the "Mechanical construction" section in the Technical Information.

5.2 Installation conditions

- Moisture must not penetrate the housing when mounting the device, establishing the electrical connection and during operation.
- For M12 plug made of metal: Do not remove the protection cap (only in IP69) of M12 plug connection until shortly before electrical connection.
- Do not clean or touch process isolating diaphragms with hard and/or pointed objects.
- Do not remove process isolating diaphragm protection until shortly before installation.
- Always tighten the cable entry firmly.
- Point the cable and connector downwards where possible to prevent moisture from entering (e.g. rain or condensation water).
- Protect housing against impact.
- For devices with gauge pressure sensor, the following applies:

NOTICE

If a heated device is cooled in the course of a cleaning process (by cold water, for example), a vacuum develops for a short time causing moisture to penetrate the sensor via the pressure compensation element (1).

Device could be destroyed!

- ▶ In the event of this happening, mount the device in such a way that the pressure compensation element (1) is pointing downwards at an angle or to the side, if possible.

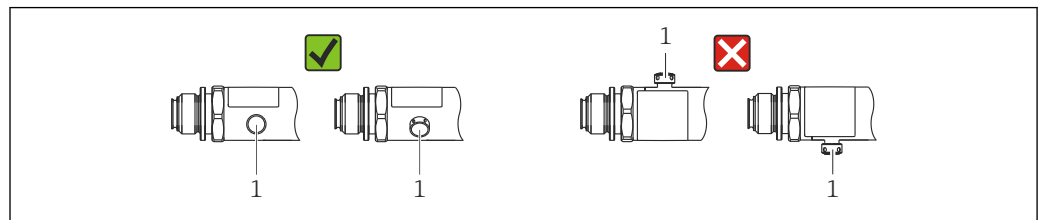

A0022252

5.3 Influence of the installation position

Any orientation is possible. However, the orientation may cause a zero point shift i.e. the measured value does not show zero when the vessel is empty or partially full.

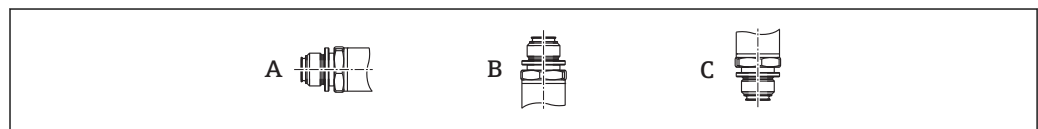

A0024708

Type	Process isolating diaphragm axis is horizontal (A)	Process isolating diaphragm pointing upwards (B)	Process isolating diaphragm pointing downwards (C)
PMP23	Calibration position, no effect	Up to +4 mbar (+0.058 psi)	Up to -4 mbar (-0.058 psi)

5.4 Mounting location

5.4.1 Pressure measurement

Pressure measurement in gases

Mount the device with shutoff device above the tapping point so that any condensate can flow into the process.

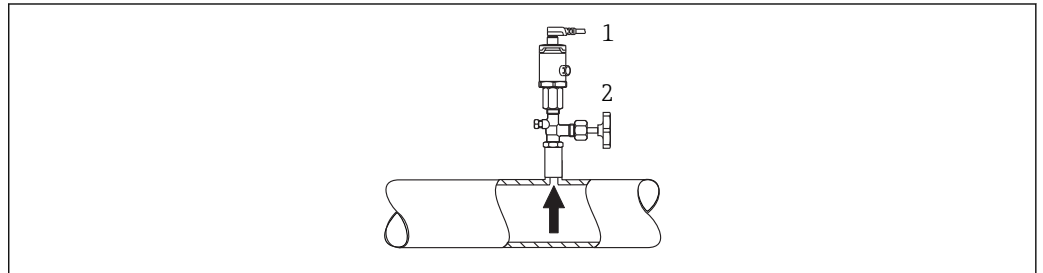

A0021904

- 1 Device
- 2 Shutoff device

Pressure measurement in vapors

For pressure measurement in vapors, use a siphon. The siphon reduces the temperature to almost ambient temperature. Mount the device with a shutoff device at the same height as the tapping point.

Advantage:

only minor/negligible heat effects on the device.

Note the max. permitted ambient temperature of the transmitter!

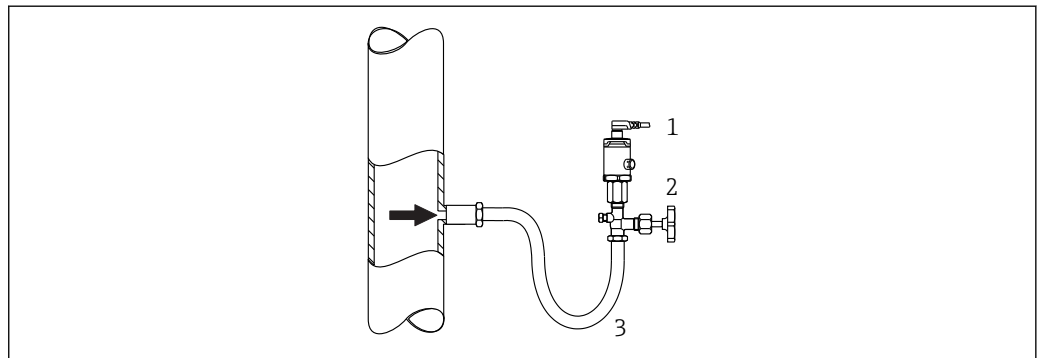

A0024395

- 1 Device
- 2 Shutoff device
- 3 Siphon

Pressure measurement in liquids

Mount the device with a shutoff device at the same height as the tapping point.

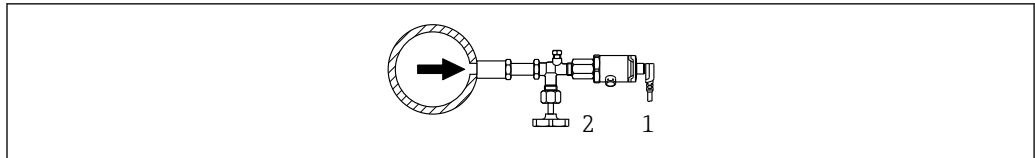

A0024399

- 1 Device
- 2 Shutoff device

5.4.2 Level measurement

- Always install the device below the lowest measuring point.
- Do not install the device at the following positions:
 - In the filling curtain
 - In the tank outlet
 - in the suction area of a pump
 - Or at a point in the tank which could be affected by pressure pulses from the agitator.

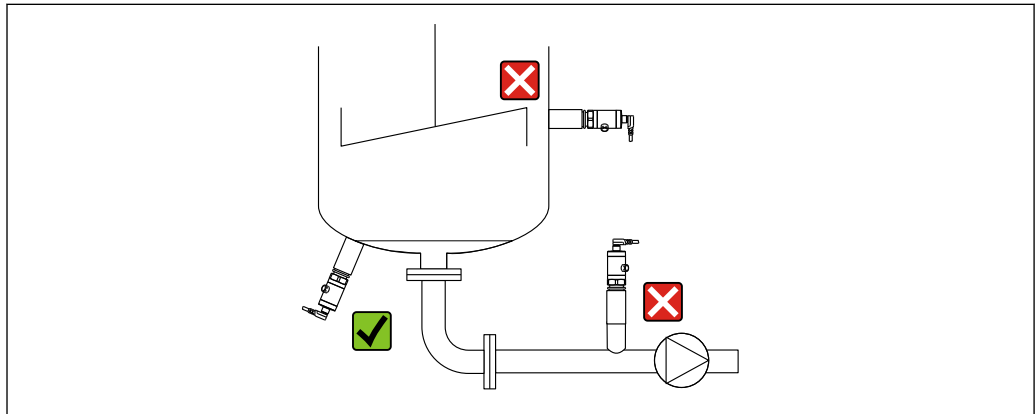

A0024405

5.5 Mounting of the profile seal for universal process mounting adapter

For details on mounting, see KA00096F/00/A3.

5.6 Post-installation check

<input type="checkbox"/>	Is the device undamaged (visual inspection)?
<input type="checkbox"/>	Does the device comply with the measuring point specifications? For example: <ul style="list-style-type: none"> ▪ Process temperature ▪ Process pressure ▪ Ambient temperature range ▪ Measuring range
<input type="checkbox"/>	Are the measuring point identification and labeling correct (visual inspection)?
<input type="checkbox"/>	Is the device adequately protected against precipitation and direct sunlight?
<input type="checkbox"/>	Are the securing screws tightened securely?
<input type="checkbox"/>	Is the pressure compensation element pointing downwards at an angle or to the side?
<input type="checkbox"/>	To prevent moisture from penetrating, ensure that the connecting cables/plugs are pointing downwards.

6 Electrical connection

6.1 Connecting the measuring unit

6.1.1 Terminal assignment

⚠ WARNING

Risk of injury from the uncontrolled activation of processes!

- ▶ Switch off the supply voltage before connecting the device.
- ▶ Make sure that downstream processes are not started unintentionally.

⚠ WARNING

Electrical safety is compromised by an incorrect connection!

- ▶ In accordance with IEC/EN61010 a suitable circuit breaker must be provided for the device .
- ▶ The device must be operated with a 500 mA fine-wire fuse (slow-blow).
- ▶ Protective circuits against reverse polarity are integrated.

Connect the device in the following order:

1. Check that the supply voltage corresponds to the supply voltage indicated on the nameplate.
2. Connect the device in accordance with the following diagram.

Switch on the supply voltage.

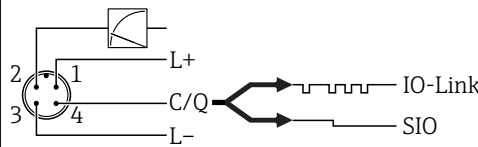
Device	M12 plug
PMP23	 <p>1 Supply voltage + 2 4-20 mA 3 Supply voltage - 4 C/Q (IO-Link communication or SIO mode)</p> <p style="text-align: right;">A0034006</p>

6.1.2 Supply voltage

Electronic version	Device	Supply voltage
IO-Link	PMP23	10 to 30 V DC IO-Link communication is guaranteed only if the supply voltage is at least 18 V.

6.1.3 Current consumption and alarm signal

Electronic version	Device	Current consumption	Alarm signal ¹⁾
IO-Link	PMP23	Maximum current consumption: ≤ 300 mA	

1) For MAX alarm (factory setting)

6.2 Switching capacity

- Switch status ON: $I_a \leq 200 \text{ mA}$ ^{1) 2)}; switch status OFF: $I_a \leq 1 \text{ mA}$
- Switch cycles: $>10,000,000$
- Voltage drop PNP: $\leq 2 \text{ V}$
- Overload protection: Automatic load testing of switching current;
 - Max. capacitive load: $1 \mu\text{F}$ at max. supply voltage (without resistive load)
 - Max. cycle duration: 0.5 s ; min. t_{on} : $40 \mu\text{s}$
 - Periodic disconnection from protective circuit in the event of overcurrent ($f = 2 \text{ Hz}$) and "F804" displayed

6.3 Connection data

6.3.1 Load (for 4 to 20 mA devices)

In order to guarantee sufficient terminal voltage, a maximum load resistance R_L (including line resistance) must not be exceeded depending on the supply voltage U_B of the supply unit.

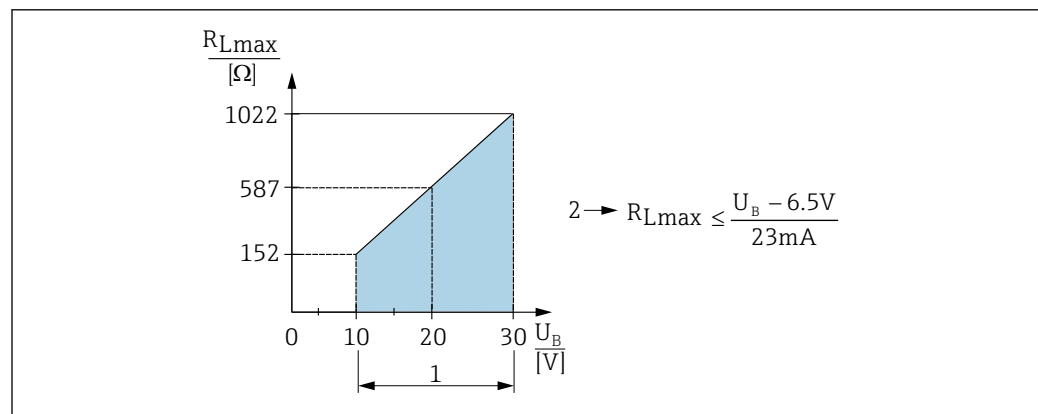

A0031107

- 1 Power supply 10 to 30 V DC
 2 $R_{L\text{max}}$ Maximum load resistance
 U_B Supply voltage

- Error current is output and "S803" displayed (output: MIN alarm current)
- Periodic checking to establish if it is possible to quit fault state

6.4 Post-connection check

<input type="checkbox"/>	Is the device or cable undamaged (visual check)?
<input type="checkbox"/>	Do the cables comply with the requirements?
<input type="checkbox"/>	Do the mounted cables have adequate strain relief?
<input type="checkbox"/>	Are all the cable glands installed, firmly tightened and leak-tight?
<input type="checkbox"/>	Does the supply voltage match the specifications on the nameplate?

- 1) 100 mA can be guaranteed over the entire temperature range for the switch output 1 x PNP + 4 to 20 mA output. For lower ambient temperatures, higher currents are possible but cannot be guaranteed. Typical value at 20 °C (68 °F) approx. 200 mA. 200 mA can be guaranteed over the entire temperature range for the "1 x PNP" switch output.
- 2) Larger currents are supported, thus deviating from the IO-Link standard.

<input type="checkbox"/>	Is the terminal assignment correct ?
<input type="checkbox"/>	If required: has protective ground connection been established?

7 Operation options

7.1 Operation with an operating menu

7.1.1 IO-Link

IO-Link information

IO-Link is a point-to-point connection for communication between the measuring device and an IO-Link master. The measuring device features an IO-Link communication interface type 2 with a second IO function on pin 4. This requires an IO-Link-compatible assembly (IO-Link master) for operation. The IO-Link communication interface enables direct access to the process and diagnostic data. It also provides the option of configuring the measuring device while in operation.

Physical layer, the measuring device supports the following features:

- IO-Link specification: version 1.1
- IO-Link Smart Sensor Profile 2nd Edition (supports minimum scope of IdentClass)
- SIO mode: Yes
- Speed: COM2; 38.4 kBaud
- Minimum cycle time: 2.5 msec.
- Process data width: 32 bit
- IO-Link data storage: Yes
- Block configuration: Yes

IO-Link download

<http://www.endress.com/download>

- Select "Software" as the media type.
- Select "Device Driver" as the software type.
Select IO-Link (IODD).
- In the "Text Search" field enter the device name.

<https://ioddfinder.io-link.com/>

Search by

- Manufacturer
- Article number
- Product type

7.1.2 Structure of the operating menu

The menu structure has been implemented according to VDMA 24574-1 and complemented by Endress+Hauser-specific menu items.

 For an overview of the operating menu, see the →  43

8 System integration

8.1 Process data

The measuring device has a current output and a switch output. The status of the switch output is transmitted in the form of process data via IO-Link.

- In the SIO mode, switch output 1 is switched at pin 4 of the M12 plug. In the IO-Link communication mode, this pin is reserved exclusively for communication.
- The current output at pin 2 of the M12 plug is always active or can be optionally deactivated via IO-Link.
- The device's process data are transmitted cyclically in 32-bit chunks.

Bit	0 (LSB)	1	...	28	29 (MSB)	30	31
Measuring device	Pressure value					OU1	res.

Bit 31 is reserved. Bit 30 provides the status of the switch output.

Here, 1 or DC 24 V corresponds to the logical "closed" state on the switch output. The remaining 30 bits contain the analog raw measured value of the device. This value has yet to be scaled by the target system to the nominal operating range of the existing measuring device.

Bit	Process value	Value range
30	OU1	0 = open 1 = closed
0 to 29	Raw value	Int30

The decimal separator must be set with a gradient. The gradients depend on the unit in question. The following units are available:

- bar: 0.0001
- kPa: 0.01
- MPa: 0.00001
- psi: 0.001

Examples:

Pressure value	Transmitted	Scaled with gradient
-320 mbar	-3 200	-0.32
22 bar	220 000	22
133 Pa	13 300	133
665 psi	665 000	665
399.5 bar	3 995 000	399.5

8.2 Reading out and writing device data (ISDU – Indexed Service Data Unit)

Device data are always exchanged acyclically and at the request of the IO-Link master. Using the device data, the following parameter values or device statuses can be read out:

8.2.1 Endress+Hauser-specific device data

Designation	ISDU (dec)	ISDU (hex)	Size (byte)	Data type	Access	Default value	Value range	Offset/Gradient	Data storage	Range limits
Extended Ordercode	259	0x0103	60	String	ro					
ENP_VERSION	257	0x0101	16	String	ro	36587				
Device Type	256	0x0100	2	UInteger16	ro	0x92FF				
Simulation Switch Output (OU1)	85	0x0055	1	unit	r/w		0 ~ off 1 ~ low 2 ~ high		No	
Simulation Current Output (OU2)	66	0x0042	1	unit	r/w		0 ~ off 3 ~ 3.5 mA 4 ~ 4 mA 5 ~ 8 mA 6 ~ 12 mA 7 ~ 16 mA 8 ~ 20 mA 9 ~ 21.95 mA		No	
Unit changeover (UNI)	67	0x0043	1	unit	r/w		0 ~ bar 1 ~ kPa 2 ~ psi 3 ~ MPa		Yes	
Zero point configuration (ZRO)	68	0x0044	4	int	r/w	0	as 00.00% Default 0.00%		Yes	
Zero point adoption (GTZ)	69	0x0045	1	unit	w				No	
Damping (TAU)	70	0x0046	2	unit	r/w	20	in 000.0 sec Default 2.0 sec	0.1	Yes	
Value for 4 mA (STL)	71	0x0047	4	int	r/w	0	as 00.00% Default 0.00%	bar: 0/0.001 kPa: 0/0.1 MPa: 0/0.0001 psi: 0/0.01	Yes	
Value for 20 mA (STU)	72	0x0048	4	int	r/w	10000	as 00.00% Default 100.00%	bar: 0/0.001 kPa: 0/0.1 MPa: 0/0.0001 psi: 0/0.01	Yes	
Pressure applied for 4mA (GTL)	73	0x0049	1	unit	w				No	
Pressure applied for 20mA (GTU)	74	0x004A	1	unit	w				No	
Alarm current (FCU)	75	0x004B	1	unit	r/w	MAX	0 ~ MIN 1 ~ MAX		Yes	
FUNC	88	0x0058	1	unit	r/w	1	0 ~ off 1 ~ I		Yes	
Switch point value/Upper value for pressure window, output 1 (SP1/FH1)	77	0x004D	4	int	r/w	9000	as 00.00% Default 90%	bar: 0/0.001 kPa: 0/0.1 MPa: 0/0.0001 psi: 0/0.01	Yes	
Switchback point value/Lower value for pressure window, output 1 (rP1/FL1)	78	0x004E	4	int	r/w	1000	as 00.00% Default 10%	bar: 0/0.001 kPa: 0/0.1 MPa: 0/0.0001 psi: 0/0.01	Yes	
Switching delay time, Output 1 (dS1)	79	0x004F	2	unit	r/w	0	in 00.00 sec	0/0.01	Yes	

Designation	ISDU (dec)	ISDU (hex)	Size (byte)	Data type	Access	Default value	Value range	Offset/Gradient	Data storage	Range limits
Switchback delay time, Output 1 (dR1)	80	0x0050	2	unit	r/w	0	in 00.00 sec	0/0.01	Yes	
Output 1 (Ou1)	81	0x0051	1	unit	r/w	HNO	0 ~ HNO ¹⁾ 1 ~ HNC ¹⁾ 2 ~ FNO ¹⁾ 3 ~ FNC ¹⁾		Yes	
Hi Max value (maximum indicator)	82	0x0052	4	int	ro				No	
Lo Min value (minimum indicator)	83	0x0053	4	int	ro				No	
Revisioncounter (RVC)	84	0x0054	2	unit	ro				No	

1) For an explanation of the abbreviations, see the parameter description → 44

8.2.2 IO-Link-specific device data

Designation	ISDU (dec)	ISDU (hex)	Size (byte)	Data type	Access	Default value	Data storage
Serial number	21	0x0015	max. 16	String	ro		
Firmware version	23	0x0017	max. 64	String	ro		
ProductID	19	0x0013	max. 64	String	ro	PMP23	
ProductName	18	0x0012	max. 64	String	ro	Cerabar	
ProductText	20	0x0014	max. 64	String	ro	Absolute and gauge pressure	
VendorName	16	0x0010	max. 64	String	ro	Endress+Hauser	
VendorText	17	0x0011	max. 64	String	ro	People for Process Automation	
Hardware Revision	22	0x0016	max. 64	String	ro		
Application Specific Tag	24	0x0018	32	String	r/w		
Actual Diagnostics (STA)	260	0x0104	4	String	ro		No
Last Diagnostic (LST)	261	0x0105	4	String	ro		No

8.2.3 System commands

Designation	ISDU (dec)	ISDU (hex)	Value range	Access
Reset to factory settings (RES)	2	0x0002	130	w
Device Access Locks.Data Storage Lock	12	0x000C	0 ~ False 2 ~ True	rw

9 Commissioning

If an existing configuration is changed, measuring operation continues! The new or modified entries are only accepted once the setting has been made.

If block parameter configuration is used, a parameter change is only adopted after the parameter download.

⚠ WARNING

Risk of injury from the uncontrolled activation of processes!

- ▶ Make sure that downstream processes are not started unintentionally.

⚠ WARNING

If a pressure smaller than the minimum permitted pressure or greater than the maximum permitted pressure is present at the device, the following messages are output in succession:

- ▶ S140
- ▶ F270



NOTICE

An IO-DD with corresponding default values is used for all pressure measuring ranges. This IO-DD applies for all measuring ranges! The default values of this IO-DD can be inadmissible for this device. IO-Link messages (e.g. "Parameter value above limit") may be displayed when the device is updated with these default values. Existing values are not accepted in this case. The default values apply exclusively to the 10 bar (150 psi) sensor.

- ▶ The data must first be read out of the device before default values are written from the IO-DD to the device.



9.1 Function check

Before commissioning your measuring point, ensure that the post-installation and post-connection check have been performed:

- "Post-installation check" checklist →  16
- "Post-connection check" checklist →  18

9.2 Commissioning with an operating menu

Commissioning comprises the following steps:

- Configure pressure measurement →  25
- Where applicable, perform position adjustment →  27
- Where applicable, configure process monitoring →  29

9.3 Configuring pressure measurement

9.3.1 Calibration without reference pressure (dry calibration = calibration without medium)

Example:



In this example, a device with a 400 mbar (6 psi) sensor is configured for the measuring range 0 to 300 mbar (0 to 4.4 psi).



The following values should be assigned:

- 0 mbar = 4 mA value
- 300 mbar (4.4 psi) = 20 mA value

Prerequisite:

This is a theoretical calibration, i.e. the pressure values for the lower and upper range are known. It is not necessary to apply pressure.

 Due to the orientation of the device, there may be pressure shifts in the measured value, i.e. the measured value is not zero in a pressureless condition. For information on how to perform position adjustment, see the "Performing position adjustment" section →  27.

 For a description of the parameters mentioned and possible error messages, see the "Description of device parameters" section →  44 and →  37.

Performing the configuration

1. Select a pressure unit, here "bar" for example, via the **Unit changeover (UNI)** parameter.
2. Select **Value for 4 mA (STL)** parameter. Enter the value (0 bar (0 psi)) and confirm.
 - ↳ This pressure value is assigned to the lower current value (4 mA).
3. Select **Value for 20 mA (STU)** parameter. Enter the value (300 mbar (4.4 psi)) and confirm.
 - ↳ This pressure value is assigned to the upper current value (20 mA).

The measuring range is configured for 0 to 300 mbar (0 to 4.4 psi).

9.3.2 Calibration with reference pressure (wet calibration = calibration with medium)

Example:



In this example, a device with a 400 mbar (6 psi) sensor is configured for the measuring range 0 to 300 mbar (0 to 4.4 psi).



The following values should be assigned:

- 0 mbar = 4 mA value
- 300 mbar (4.4 psi) = 20 mA value

Prerequisite:

The pressure values 0 mbar and 300 mbar (4.4 psi) can be specified. The device is already mounted, for example.

 Due to the orientation of the device, there may be pressure shifts in the measured value, i.e. the measured value is not zero in a pressureless condition. For information on how to perform position adjustment, see the "Performing position adjustment" section →  27.

 For a description of the parameters mentioned and possible error messages, see the "Description of device parameters" section →  44 and →  37.

Performing the configuration

1. Select a pressure unit, here "bar" for example, via the **Unit changeover (UNI)** parameter.
2. The pressure for the LRV (4 mA value) is present at the device, here 0 bar (0 psi) for example. Select **Pressure applied for 4mA (GTL)** parameter. The selection is confirmed by pressing "Get Lower Limit".
 - ↳ The pressure value present is assigned to the lower current value (4 mA).
3. The pressure for the URV (20 mA value) is present at the device, here 300 mbar (4.4 psi) for example. Select **Pressure applied for 20mA (GTU)** parameter. The selection is confirmed by pressing "Get Lower Limit".
 - ↳ The pressure value present is assigned to the upper current value (20 mA).

The measuring range is configured for 0 to 300 mbar (0 to 4.4 psi).

9.4 Performing position adjustment

Zero point configuration (ZRO)

Navigation	Parameter → Application → Sensor → Zero point configuration (ZRO)
Description	<p>(Typically absolute pressure sensor)</p> <p>A pressure shift resulting from the orientation of the device can be corrected by the position adjustment.</p> <p>The pressure difference between zero (set point) and the measured pressure must be known.</p>
Prerequisite	<p>An offset is possible (parallel shifting of the sensor characteristic) to correct the orientation and any zero point drift. The set value of the parameter is subtracted from the "raw measured value". The requirement to be able to perform a zero point shift without changing the span is met with the offset function.</p> <p>Maximum offset value = ± 20 % of the sensor nominal range.</p> <p>If an offset value is entered that shifts the span beyond the physical limits of the sensor, the value is admitted but a warning message is generated and displayed via IO-Link. The warning message only disappears when the span is within the sensor limits, taking the offset value currently configured into consideration.</p> <p>The sensor can</p> <ul style="list-style-type: none"> ■ be operated in a physically unfavorable range, i.e. outside its specifications, or ■ be operated by making appropriate corrections to the offset or span. <p>Raw measured value – (manual offset) = display value (measured value)</p>
Example	<ul style="list-style-type: none"> ■ Measured value = 0.002 bar (0.029 psi) ■ Set the manual offset to 0.002. ■ Display value (measured value) after position adjustment = 0 bar (0 psi) ■ The current value is also corrected.
Note	Setting in increments of 0.001. As the value is entered numerically, the increment depends on the measuring range
Options	No selection. The user is free to edit the values.
Factory setting	0

Zero point adoption (GTZ)

Navigation	Parameter → Application → Sensor → Zero point adoption (GTZ)
Description	<p>(Typically gauge pressure sensor)</p> <p>A pressure shift resulting from the orientation of the device can be corrected by the position adjustment.</p> <p>The pressure difference between zero (set point) and the measured pressure need not be known.</p>

Prerequisite

The pressure value present is automatically adopted as the zero point.

An offset is possible (parallel shifting of the sensor characteristic) to correct the orientation and any zero point drift. The accepted value of the parameter is subtracted from the "raw measured value". The requirement to be able to perform a zero point shift without changing the span is met with the offset function.

Maximum offset value = $\pm 20\%$ of the sensor nominal range.

If an offset value is entered that shifts the span beyond the physical limits of the sensor, the value is admitted but a warning message is generated and displayed via IO-Link. The warning message only disappears when the span is within the sensor limits, taking the offset value currently configured into consideration.

The sensor can

- be operated in a physically unfavorable range, i.e. outside its specifications, or
- be operated by making appropriate corrections to the offset or span.

Raw measured value – (manual offset) = display value (measured value)

Example 1

- Measured value = 0.002 bar (0.029 psi)
- Use the **Zero point adoption (GTZ)** parameter to correct the measured value with the value, e.g. 0.002 bar (0.029 psi). This means that you are assigning the value 0 bar (0 psi) to the pressure present.
- Display value (measured value) after position adjustment = 0 bar (0 psi)
- The current value is also corrected.
- Where applicable, check and correct switch points and span settings.

Example 2

Sensor measuring range: -0.4 to +0.4 bar (-6 to +6 psi) (SP1 = 0.4 bar (6 psi); STU = 0.4 bar (6 psi))

- Measured value = 0.08 bar (1.2 psi)
 - Use the **Zero point adoption (GTZ)** parameter to correct the measured value with the value, e.g. 0.08 bar (1.2 psi). This means that you are assigning the value 0 mbar (0 psi) to the pressure present.
 - Display value (measured value) after position adjustment = 0 bar (0 psi)
 - The current value is also corrected.
 - Warnings C431 or C432 appear because the value 0 bar (0 psi) was assigned to the real value of 0.08 bar (1.2 psi) present and the sensor measuring range was thus exceeded by $\pm 20\%$.
- SP1 and STU values must be readjusted downwards by 0.08 bar (1.2 psi).

9.5 Configuring process monitoring

To monitor the process, it is possible to specify a pressure range which is monitored by the limit switch. Both monitoring versions are described below. The monitoring function allows the user to define optimum ranges for the process (with high yields etc.) and deploy limit switches to monitor the ranges.



9.5.1 Digital process monitoring (switch output)

It is possible to select defined switch points and switchback points which act as NO or NC contacts depending on whether a window function or hysteresis function is configured.

Function	Selection	Output	Abbreviation for operation
Hysteresis	Hysteresis normally open	NO contact	HNO
Hysteresis	Hysteresis normally closed	NC contact	HNC
Window	Window normally open	NO contact	FNO
Window	Window normally closed	NC contact	FNC

If the device is restarted within the given hysteresis, the switch output is open (0 V present at the output).

9.5.2 Analog process monitoring (4 to 20 mA output)

- The 3.8 to 20.5 mA signal range is controlled according to NAMUR NE 43.
- The alarm current and current simulation are exceptions:
 - If the defined limit is exceeded, the device continues measuring linearly. The output current increases linearly up to 20.5 mA and holds the value until the measured value drops below 20.5 mA again or the device detects an error →  37.
 - If the defined limit is undershot, the device continues measuring linearly. The output current decreases linearly to 3.8 mA and holds the value until the measured value rises above 3.8 mA again or the device detects an error →  37.

9.5.3 Switch output 1

Behavior of switch output

Switch point value/Upper value for pressure window, output 1 (SP1/FH1)
Switchback point value/Lower value for pressure window, output 1 (RP1/FL1)

Navigation

Parameter → Application → Switch output 1 → Switch point value.../Switchback point value...

Prerequisite

The following functions are available only if a hysteresis function has been configured for the switch output (output 1 (Ou1)).

Description of behavior of SP1/RP1

The hysteresis is implemented using the **SP1** and **RP1** parameters. Since the parameter settings depend on one another, the parameters are described all together. The switch point "SP1" and switchback point "RP1" can be defined with these functions (e.g. for pump control). When the set switch point "SP1" is reached (with increasing pressure), an electrical signal change takes place at the switch output. When the set switchback point "RP1" is reached (with decreasing pressure), an electrical signal change takes place at the switch output. The difference between the value of switch point "SP1" and the value of switchback point "RP1" is known as the hysteresis. The configured value for the switch point "SP1" must be greater than the switchback point "RP1"! A diagnostic message is displayed if a switch point "SP1" is entered that is \leq the switchback point "RP1". While it is possible to make this entry, it does not take effect in the device. The entry must be corrected!

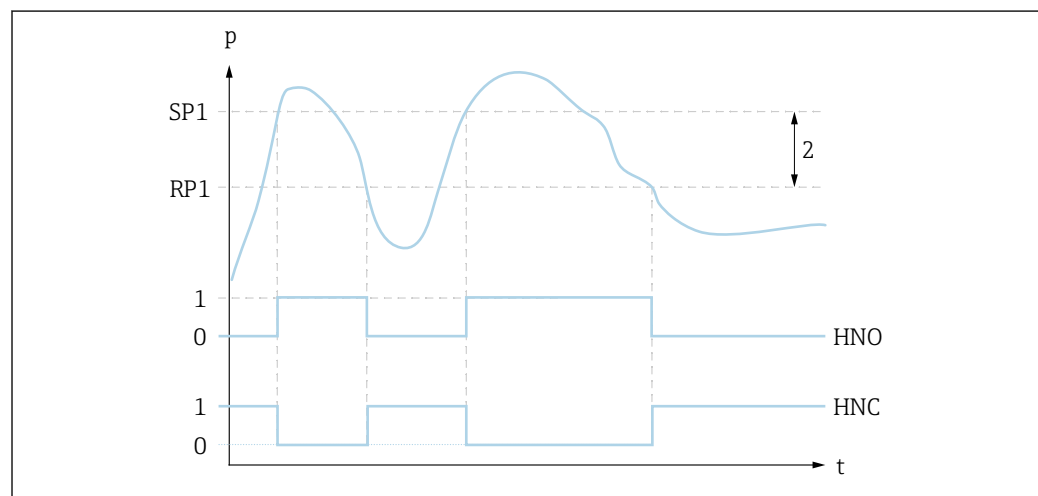

A0034025

0 0-signal. Output open in quiescent state
1 1-signal. Output closed in quiescent state
2 Hysteresis
SP1 Switch point
RP1 Switchback point
HNO NO contact
HNC NC contact

i To prevent switch-on and switch-off if values are around the switch point "SP1" or switchback point "RP1", a delay can be set for the relevant points. In this regard, see the **Switching delay time, output 1 (dS1)** and **Switchback delay time, output 1 (dR1)** parameter descriptions.

Prerequisite

The following functions are available only if a window function has been configured for the switch output (output 1 (Ou1)).

Description of behavior of FH1/FL1

The window function is implemented using the **FH1** and **FL1** parameters. Since the parameter settings depend on one another, the parameters are described all together. The upper value of the pressure window "FH1" and the lower value of the pressure window "FL1" can be defined with these functions (e.g., for monitoring a certain pressure range). When the lower value of the pressure window "FL1" is reached (with increasing or decreasing pressure), an electrical signal change takes place at the switch output. When the upper value of the pressure window "FH1" is reached (with increasing or decreasing pressure), an electrical signal change takes place at the switch output. The difference between the upper value of the pressure window "FH1" and the lower value of the pressure window "FL1" is known as the pressure window. The upper value of the pressure window "FH1" must be greater than the lower value of the pressure window "FL1"! A diagnostic message is displayed if the upper value entered for the pressure window "FH1" is less than the lower value of the pressure window "FL1". While it is possible to make this entry, it does not take effect in the device. The entry must be corrected!

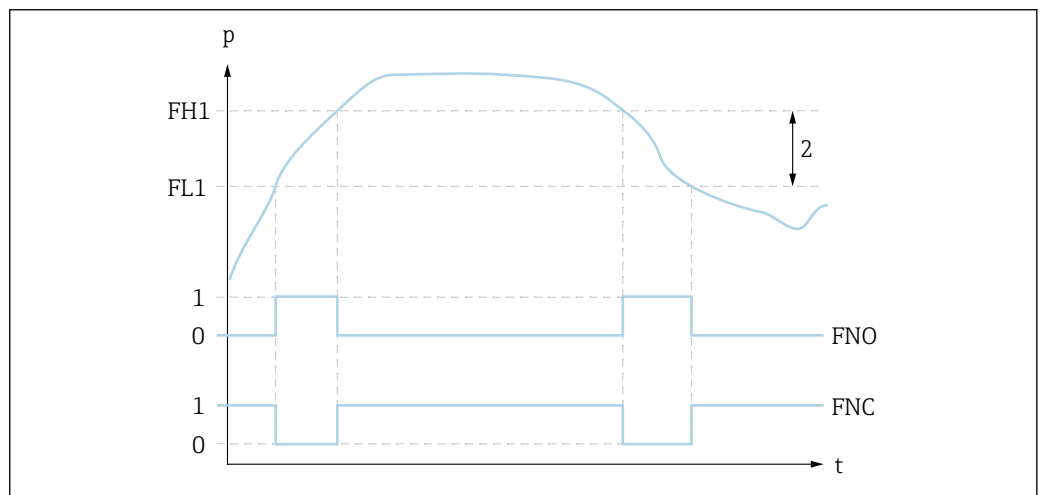

A0034026

0 0-signal. Output open in quiescent state

1 1-signal. Output closed in quiescent state

2 Pressure window (difference between the value of the high window "FH1" and the low window "FL1")

FNO NO contact

FNC NC contact

FH1 Upper value of the pressure window

FL1 Lower value of the pressure window

Options

No selection. The user is free to edit the values.

Factory setting

Factory setting (if no customer-specific setting is ordered):
Switch point SP1/FH1: 90%; switchback point RP1/FL1: 10%

Switching delay

Switching delay time, output 1 (dS1) Switchback delay time, output 1 (dR1)

Note

The switching delay time/switchback delay time function is implemented using the **dS1** and **dR1** parameters. Since the parameter settings depend on one another, the parameters are described all together.

- dS1 = switching delay time, output 1
- dR1 = switchback delay time, output 1

Navigation

Parameter → Application → Switch output 1 → Switching delay.../Switchback delay...

Description

To prevent switch-on and switch-off if values are around the switch point "SP1" or the switchback point "RP1", a delay in a range of 0 – 50 seconds, to two decimal places, can be set for the individual points.

If the measured value leaves the switching range during the delay time, the delay time starts again.

Example

- SP1 = 2 bar (29 psi)
- RP1 = 1 bar (14.5 psi)
- dS1 = 5 seconds
- dR1 = 2 seconds

dS1/: ≥ 2 bar (29 psi) must be present for at least 5 seconds for SP1 to become active.
dR1/: ≥ 1 bar (14.5 psi) must be present for at least 2 seconds for RP1 to become active.

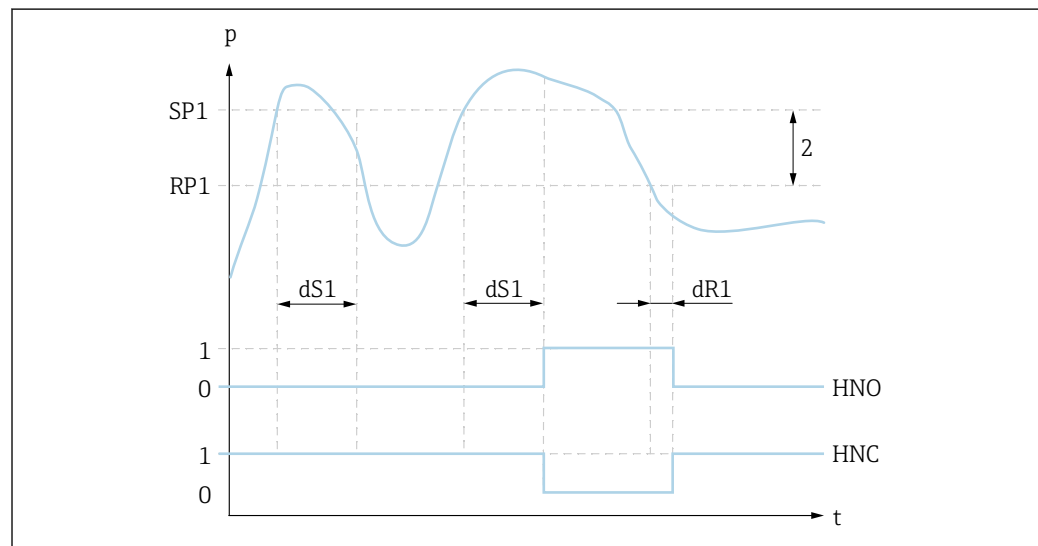

A0034027

0 0-signal. Output open in quiescent state

1 1-signal. Output closed in quiescent state

2 Hysteresis (difference between the value of the switch point "SP1" and the value of the switchback point "RP1")

HNO NO contact

HNC NC contact

SP1 Switch point 1

RP1 Switchback point 1

dS1 Set time for which the specific switch point must be reached continuously without interruption until an electrical signal change takes place

dR1 Set time for which the specific switchback point must be reached continuously without interruption until an electrical signal change takes place

Input range 0.00 - 50.00 seconds

Factory setting 0

Output 1 (OU1)

Navigation Parameter → Application → Switch output 1 → Output 1 (OU1)

Description

- Hysteresis normally open (HNO):
The switch output is specified as a NO contact with hysteresis properties.
- Hysteresis normally closed (HNC):
The switch output is specified as an NC contact with hysteresis properties.
- Window normally open (FNO):
The switch output is specified as a NO contact with window properties.
- Window normally closed (FNC):
The switch output is specified as an NC contact with window properties.

Options

- Hysteresis normally open (HNO)
- Hysteresis normally closed (HNC)
- Window normally open (FNO)
- Window normally closed (FNC)

Factory setting Hysteresis normally open (HNO) or as per order specifications

9.6 Current output

Operating Mode (FUNC)

Navigation Parameter → Application → Sensor → Operating Mode (FUNC)

Description Enables the desired behavior of output 2 (not IO-Link output)

Options

Options:

- OFF
- 4-20 mA (I)

Value for 4 mA (STL)

Navigation Parameter → Application → Current output → Value for 4 mA (STL)

Description Assignment of the pressure value which should correspond to the 4 mA value. It is possible to invert the current output. To do so, assign the pressure upper range value to the lower measuring current.

Note Enter the value for 4 mA in the selected pressure unit anywhere within the measuring range. The value can be entered in increments of 0.1 (increment depends on the measuring range).

Options No selection. The user is free to edit the values.

Factory setting 0.0 or as per order specifications

Value for 20 mA (STU)

Navigation Parameter → Application → Current output → Value for 20 mA (STU)

Description Assignment of the pressure value which should correspond to the 20 mA value. It is possible to invert the current output. To do so, assign the pressure lower range value to the upper measuring current.

Note Enter the value for 20 mA in the selected pressure unit anywhere within the measuring range. The value can be entered in increments of 0.1 (increment depends on the measuring range).

Options No selection. The user is free to edit the values.

Factory setting Upper measuring limit or as per order specifications.

Pressure applied for 4mA (GTL)

Navigation Parameter → Application → Current output → Pressure applied for 4mA (GTL)

Description The pressure value present is automatically adopted for the 4 mA current signal. Parameter for which the current range can be assigned to any section of the nominal range. This occurs by assigning the pressure lower range value to the lower measuring current and the pressure upper range value to the upper measuring current. The pressure lower range value and upper range value can be configured independently of one another so the pressure measuring span does not remain constant. The LRV and URV pressure measuring span can be edited over the entire sensor range. An invalid TD value is indicated by diagnostic message S510. An invalid position offset is indicated by diagnostic message C431. The editing operation cannot result in the device being operated outside the minimum and maximum sensor limits.

Incorrect entries are declined as indicated by the following messages, and the last valid value prior to the change is used again:

- Parameter value above limit (0x8031)
- Parameter value below limit (0x8032)

The measured value currently present is accepted as the value for 4mA anywhere within the measuring range.

The sensor characteristic curve is shifted such that the pressure present becomes the zero value.

Pressure applied for 20mA (GTU)

Navigation Parameter → Application → Current output → Pressure applied for 20mA (GTU)

Description

The pressure value present is automatically adopted for the 20 mA current signal. Parameter for which the current range can be assigned to any section of the nominal range. This occurs by assigning the pressure lower range value to the lower measuring current and the pressure upper range value to the upper measuring current. The pressure lower range value and upper range value can be configured independently of one another so the pressure measuring span does not remain constant. The LRV and URV pressure measuring span can be edited over the entire sensor range. An invalid TD value is indicated by diagnostic message S510. An invalid position offset is indicated by diagnostic message C431. The editing operation cannot result in the device being operated outside the minimum and maximum sensor limits. Incorrect entries are declined, and the last valid value prior to the change is used again. The measured value currently present is accepted as the value for 20 mA anywhere within the measuring range. There is a parallel shift of the sensor characteristic so that the pressure present becomes the max value.

9.7 Application examples

9.7.1 Compressor control with hysteresis function

Example: The compressor is started when the pressure drops below a certain value. The compressor is switched off when a certain value is exceeded.

1. Set the switch point to 2 bar (29 psi)
2. Set the switchback point to 1 bar (14.5 psi)
3. Configure the switch output as an "NC contact" (HNC function)

The compressor is controlled by the defined settings.

9.7.2 Pump control with hysteresis function

Example: The pump should switch on when 2 bar (29 psi) is reached (increasing pressure) and switch off when 1 bar (14.5 psi) is reached (decreasing pressure).

1. Set the switch point to 2 bar (29 psi)
2. Set the switchback point to 1 bar (14.5 psi)
3. Configure the switch output as an "NO contact" (HNO function)

The pump is controlled by the defined settings.

10 Diagnostics and troubleshooting

10.1 Troubleshooting

If an illegal configuration exists in the device, the device switches to the failsafe mode.

Example:

- The diagnostic message "C485" is displayed via IO-Link.
- The device is in the simulation mode.
- If the device configuration is corrected, e.g., by resetting the device, the device quits the fault state and switches to the measuring mode.

General errors

Error	Possible cause	Remedy
Device does not respond	Supply voltage does not match the value indicated on the nameplate.	Apply correct voltage.
	The polarity of the supply voltage is wrong.	Correct the polarity.
	Connecting cables are not in contact with the terminals.	Check for electrical contact between cables and correct.
No communication	<ul style="list-style-type: none"> ■ Communication cable not connected. ■ Communication cable incorrectly attached to device. ■ Communication cable incorrectly attached to the IO-Link master. 	Check wiring and cables.
Output current ≤ 3.6 mA	Signal line is not wired correctly.	Check wiring.
No transmission of process data	There is an error in the device.	Correct errors that are displayed as a diagnostic event →  39.

10.2 Diagnostic events

10.2.1 Diagnostic message

Faults that are detected by the device's self-monitoring system are displayed as a diagnostic message via IO-Link.

Status signals

The table →  39 lists the messages that may occur. The Actual Diagnostic (STA) parameter displays the message with the highest priority. The device has four different status information codes according to NE107:



F A0013956	"Failure" A device error has occurred. The measured value is no longer valid.
M A0013957	"Maintenance required" Maintenance is required. The measured value is still valid.
C A0013959	"Function check" The device is in the service mode (e. g. during a simulation).
S A0013958	"Out of specification" The device is being operated: <ul style="list-style-type: none"> ▪ Outside its technical specifications (e. g. during warm-up or cleaning process) ▪ Outside the parameter configuration undertaken by the user (e. g. level outside of configured span)

Diagnostics event and event text

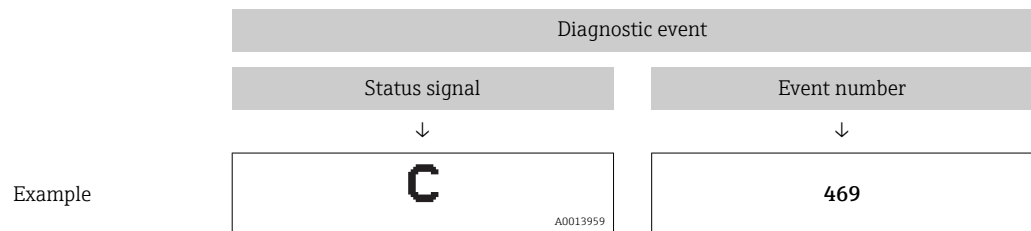
The fault can be identified by means of the diagnostic event.



If two or more diagnostic events are pending simultaneously, only the message with the highest priority is shown.

 The last diagnostic message is displayed - see Last Diagnostic (LST) in the **Diagnosis** submenu →  44.

10.2.2 Overview of diagnostic events

Status signal/ Diagnostic event	Diagnostic behavior	EventCode	Event text	Reason	Corrective measure
S140	Warning	0x180F	Sensor signal outside of permitted ranges	Overpressure or low pressure present	Operate device in the specified measuring range
S140	Warning	0x180F	Sensor signal outside of permitted ranges	Sensor defective	Replace device
F270 ^{1) 2)}	Fault	0x1800	Overpressure/low pressure	Overpressure or low pressure present	<ul style="list-style-type: none"> ▪ Check the process pressure ▪ Check sensor range ▪ Restart device
F270 ^{1) 2)}	Fault	0x1800	Defect in electronics/sensor	Defect in electronics/sensor	Replace device
C431 ³⁾	Warning	0x1805	Invalid position adjustment (Current output)	The adjustment performed would cause the sensor nominal range to be exceeded or undershot.	<p>Position adjustment + parameter of the current output must be within the sensor nominal range</p> <ul style="list-style-type: none"> ▪ Check position adjustment (see Zero point configuration (ZRO) parameter) ▪ Check measuring range (see Value for 20 mA (STU) and Value for 4 mA (STL) parameters)
C432	Warning	0x1806	Invalid position adjustment (Switching output)	The adjustment performed causes the switch points to be outside the sensor nominal range.	<p>Position adjustment + parameter of the hysteresis and window function must be within the sensor nominal range</p> <ul style="list-style-type: none"> ▪ Check position adjustment (see Zero point configuration (ZRO) parameter) ▪ Check the switch point, switchback point for hysteresis and window function
F437	Fault	0x1810	Incompatible configuration	Invalid device configuration	<ul style="list-style-type: none"> ▪ Restart device ▪ Reset device ▪ Replace device
C469	Fault	0x1803	Switch points output violated	Switch point ≤ switchback point	Check switch points at output
C485	Warning	0x8C01 ⁴⁾	Simulation active	During simulation of the switch output or current output, the device issues a warning message	Switch off simulation
S510	Fault	0x1802	Turn down violated	A change in the span results in a violation of the turn down (max. TD 5:1) Values for adjustment (lower range value and upper range value) are too close together	<ul style="list-style-type: none"> ▪ Operate device in the specified measuring range ▪ Check the measuring range
S803	Fault	0x1804	Current loop	Impedance of load resistance at analog output is too high	<ul style="list-style-type: none"> ▪ Check the cabling and load at the current output ▪ If the current output is not required, switch the current output off via the configuration
S803	Fault	0x1804	Current output not connected	Current output not connected	<ul style="list-style-type: none"> ▪ Connect current output with load ▪ If the current output is not required, switch the current output off via the configuration
F804	Fault	-	Overload at switch output	Load current too high	Increase load resistance at switch output

Status signal/ Diagnostic event	Diagnostic behavior	EventCode	Event text	Reason	Corrective measure
F804	Fault	-	Overload at switch output	Switch output defective	<ul style="list-style-type: none"> ▪ Check output wiring ▪ Replace device
S971	Warning	0x1811	Measured value is outside sensor range	The current is outside the permitted range 3.8 to 20.5 mA The present pressure value is outside the configured measuring range (but within the sensor range, if applicable)	Operate the device within the set span

- 1) The switch output is open and the current output adopts the configured alarm current. Therefore, errors affecting the switch output are not displayed since the switch output is in the safe state.
- 2) The device outputs a failure current of 0 mA if an internal communication error occurs. In all other cases the device returns the configured failure current.
- 3) If no remedial measures are taken, the warning messages are displayed following a device restart if configuration (span, switch points and offset) is performed with a gauge pressure device and readings are $> \text{URL} + 10\%$ or $< \text{LRL} + 5\%$ and with an absolute pressure device and readings are $> \text{URL} + 10\%$ or $< \text{LRL}$.
- 4) EventCode as per IO-Link standard 1.1

10.3 Behavior of the device in the event of a fault

The device displays warnings and faults via IO-Link. All the device warnings and faults are for information purposes only and do not have a safety function. The errors diagnosed by the device are displayed via IO-Link in accordance with NE107. Depending on the diagnostic message, the device behaves as per a warning or fault condition. A distinction must be made between the following types of error here:

- **Warning:**
 - The device continues measuring if this type of error occurs. The output signal is not affected (exception: simulation is active).
 - The switch output remains in the state defined by the switch points.
- **Fault:**
 - The device does **not** continue measuring if this type of error occurs. The output signal adopts its fault state (value in the event of an error - see the following section).
 - The fault state is displayed via IO-Link.
 - The switch output changes to the "open" state.
 - For the analog output option, an error is signaled with the configured alarm current behavior.

10.4 Behavior of current output in the event of a fault

The behavior of the current output in the event of a fault is regulated in accordance with NAMUR NE43.

The behavior of the current output in the event of faults is defined in the following parameters:

- **Alarm current FCU "MIN":** Lower alarm current (≤ 3.6 mA) (optional, see the following table)
 - **Alarm current FCU "MAX"** (factory setting): Upper alarm current (≥ 21 mA)
-  The selected alarm current is used for all errors.
- Errors and warning messages are displayed via IO-Link.
 - It is not possible to acknowledge errors and warnings. The relevant message disappears if the event is no longer pending.
 - The failsafe mode can be changed directly when a device is running (see the following table).

Changing the failsafe mode	After writing to the device
From MAX to MIN	Active immediately
From MIN to MAX	Active immediately

10.4.1 Alarm current

Device	Designation	Option
PMP23	Adjusted min. alarm current	IA ¹⁾

1) Product Configurator order code for "Service"

10.5 Resetting to factory settings (reset)

See the Reset to factory settings (RES) parameter description → 56.

11 Maintenance

No special maintenance work is required.

Keep the pressure compensation element (1) free from contamination.

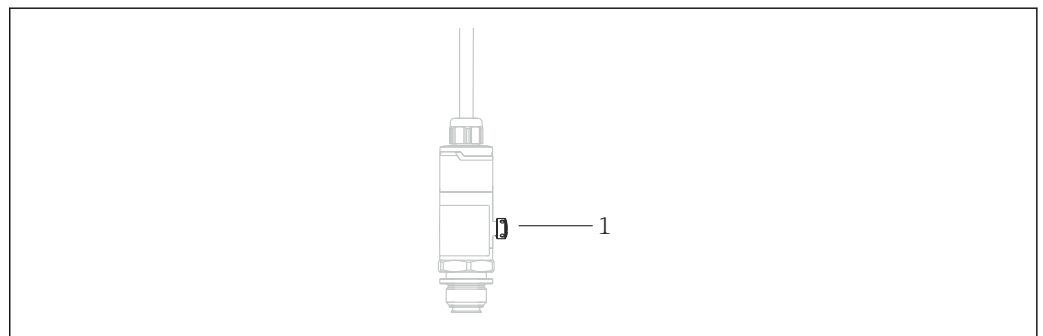

A0022141

11.1 Exterior cleaning

Please note the following points when cleaning the device:

- The cleaning agents used should not corrode the surface and the seals.
- Mechanical damage to the process isolating diaphragm, e.g. due to sharp objects, must be avoided.
- Observe the degree of protection of the device. See the nameplate if necessary → 12.

12 Repairs

12.1 General notes

12.1.1 Repair concept

Repairs are not possible.

12.2 Return

The measuring device must be returned if the wrong device has been ordered or delivered.





























As an ISO-certified company and also due to legal regulations, Endress+Hauser is obliged to follow certain procedures when handling any returned products that have been in contact with medium. To ensure swift, safe and professional device returns, please read the return procedures and conditions on the Endress+Hauser website at www.services.endress.com/return-material

12.3 Disposal

When disposing, separate and recycle the device components based on the materials.

13 Overview of the operating menu

 Depending on the parameter configuration, not all submenus and parameters are available. Information on this can be found in the parameter description under "Prerequisite".

IO-Link	Level 1	Level 2	Level 3	Details				
Identification	Extended Ordercode			→  44				
	ENP_VERSION			→  44				
	Application Specific Tag			→  44				
Diagnosis	Actual Diagnostics (STA)			→  44				
	Last Diagnostic (LST)			→  44				
	Simulation Switch Output (OU1)			→  45				
	Simulation Current Output (OU2)			→  45				
Parameters	Application	Sensor	Operating Mode (FUNC)	→  33				
			Unit changeover (UNI)	→  46				
			Zero point configuration (ZRO)	→  27				
			Zero point adoption (GTZ)	→  27				
			Damping (TAU)	→  48				
	Current output			Value for 4 mA (STL)	→  33			
				Value for 20 mA (STU)	→  34			
				Pressure applied for 4mA (GTL)	→  34			
				Pressure applied for 20mA (GTU)	→  34			
				Alarm current (FCU)	→  50			
				Switch output 1			Switch point value/Upper value for pressure window, output 1 (SP1/FH1)	→  30
							Switchback point value/Lower value for pressure window, output 1 (RP1/FL1)	→  30
							Switching delay time, output 1 (dS1)	→  32
	Switchback delay time, output 1 (dR1)	→  32						
	Output 1 (OU1)	→  33						
	System	Device Management		HI Max value (maximum indicator)	→  56			
				LO Min value (minimum indicator)	→  56			
				Revisioncounter (RVC)	→  56			
				Reset to factory settings (RES)	→  56			
				Device Access Locks.Data Storage Lock	→  57			
	Observation	Pressure			→  57			
Switch State Output (OU1)			→  57					

14 Description of device parameters

14.1 Identification

Extended ordercode

Navigation	Identification → Extended ordercode
Description	Used to replace the device. Displays the extended order code (max. 60 alphanumeric characters).
Factory setting	As per order specifications

ENP_VERSION

Navigation	Identification → ENP_VERSION
Description	Displays the ENP version (ENP: electronic name plate)

Application Specific Tag

Navigation	Identification → Application Specific Tag
Description	Used for unique identification of device in the field. Enter device tag (max. 32 alphanumeric characters).
Factory setting	As per order specifications

14.2 Diagnostics

Actual Diagnostics (STA)

Navigation	Diagnosis → Actual Diagnostics (STA)
Description	Displays the current device status.

Last Diagnostic (LST)

Navigation	Diagnosis → Last Diagnostic (LST)
Description	Displays the latest device status (error or warning) that was rectified during operation.

Simulation Switch Output (OU1)

Navigation	Diagnosis → Simulation Switch Output (OU1)
Description	The simulation affects the process data only. It does not affect the physical switch output. If a simulation is active, a warning to this effect is displayed so that it is obvious to the user that the device is in the simulation mode. A warning is communicated via IO-Link (C485 - simulation active). The simulation must be ended actively via the menu. If the device is disconnected from the power supply during the simulation and power is then resupplied, the simulation mode is not resumed, and instead the device continues operation in the measuring mode.
Options	<ul style="list-style-type: none">■ OFF■ OU1 = low (OPN)■ OU1 = high (CLS)

Simulation Current Output (OU2)

Navigation	Diagnosis → Simulation Current Output (OU2)
Description	Simulation affects the process data and the physical current output. If a simulation is active, a warning to this effect is displayed so that it is obvious to the user that the device is in the simulation mode. A warning is communicated via IO-Link (C485 - simulation active). The simulation must be ended actively via the menu. If the device is disconnected from the power supply during the simulation and then power is resupplied afterwards, the simulation mode is not resumed, and instead the device continues operation in the measuring mode.
Options	<ul style="list-style-type: none">■ OFF■ 3.5 mA■ 4 mA■ 8 mA■ 12 mA■ 16 mA■ 20 mA■ 21.95 mA

14.3 Parameters

14.3.1 Application

Sensor

Operating Mode (FUNC)

Navigation Parameter → Application → Sensor → Operating Mode (FUNC)

Description Enables the desired behavior of output 2 (not IO-Link output)

Options Options:
 ■ OFF
 ■ 4-20 mA (I)

Unit changeover (UNI)

Navigation Parameter → Application → Sensor → Unit changeover (UNI)

Description Select the pressure engineering unit. If a new pressure engineering unit is selected, all pressure-specific parameters are converted.

Switch on value Depends on order specifications.

Options ■ bar
 ■ kPa
 ■ Mpa
 ■ psi

Factory setting Depends on order specifications.

Zero point configuration (ZRO)

Navigation Parameter → Application → Sensor → Zero point configuration (ZRO)

Description (Typically absolute pressure sensor)
 A pressure shift resulting from the orientation of the device can be corrected by the position adjustment.
 The pressure difference between zero (set point) and the measured pressure must be known.

Prerequisite	<p>An offset is possible (parallel shifting of the sensor characteristic) to correct the orientation and any zero point drift. The set value of the parameter is subtracted from the "raw measured value". The requirement to be able to perform a zero point shift without changing the span is met with the offset function.</p> <p>Maximum offset value = $\pm 20\%$ of the sensor nominal range.</p> <p>If an offset value is entered that shifts the span beyond the physical limits of the sensor, the value is admitted but a warning message is generated and displayed via IO-Link. The warning message only disappears when the span is within the sensor limits, taking the offset value currently configured into consideration.</p> <p>The sensor can</p> <ul style="list-style-type: none"> ■ be operated in a physically unfavorable range, i.e. outside its specifications, or ■ be operated by making appropriate corrections to the offset or span. <p>Raw measured value – (manual offset) = display value (measured value)</p>
Example	<ul style="list-style-type: none"> ■ Measured value = 0.002 bar (0.029 psi) ■ Set the manual offset to 0.002. ■ Display value (measured value) after position adjustment = 0 bar (0 psi) ■ The current value is also corrected.
Note	Setting in increments of 0.001. As the value is entered numerically, the increment depends on the measuring range
Options	No selection. The user is free to edit the values.
Factory setting	0

Zero point adoption (GTZ)

Navigation	Parameter → Application → Sensor → Zero point adoption (GTZ)
Description	<p>(Typically gauge pressure sensor)</p> <p>A pressure shift resulting from the orientation of the device can be corrected by the position adjustment.</p> <p>The pressure difference between zero (set point) and the measured pressure need not be known.</p>
Prerequisite	<p>The pressure value present is automatically adopted as the zero point.</p> <p>An offset is possible (parallel shifting of the sensor characteristic) to correct the orientation and any zero point drift. The accepted value of the parameter is subtracted from the "raw measured value". The requirement to be able to perform a zero point shift without changing the span is met with the offset function.</p> <p>Maximum offset value = $\pm 20\%$ of the sensor nominal range.</p> <p>If an offset value is entered that shifts the span beyond the physical limits of the sensor, the value is admitted but a warning message is generated and displayed via IO-Link. The warning message only disappears when the span is within the sensor limits, taking the offset value currently configured into consideration.</p> <p>The sensor can</p> <ul style="list-style-type: none"> ■ be operated in a physically unfavorable range, i.e. outside its specifications, or ■ be operated by making appropriate corrections to the offset or span. <p>Raw measured value – (manual offset) = display value (measured value)</p>

Example 1

- Measured value = 0.002 bar (0.029 psi)
- Use the **Zero point adoption (GTZ)** parameter to correct the measured value with the value, e.g. 0.002 bar (0.029 psi). This means that you are assigning the value 0 bar (0 psi) to the pressure present.
- Display value (measured value) after position adjustment = 0 bar (0 psi)
- The current value is also corrected.
- Where applicable, check and correct switch points and span settings.

Example 2

Sensor measuring range: -0.4 to +0.4 bar (-6 to +6 psi) (SP1 = 0.4 bar (6 psi); STU = 0.4 bar (6 psi))

- Measured value = 0.08 bar (1.2 psi)
 - Use the **Zero point adoption (GTZ)** parameter to correct the measured value with the value, e.g. 0.08 bar (1.2 psi). This means that you are assigning the value 0 mbar (0 psi) to the pressure present.
 - Display value (measured value) after position adjustment = 0 bar (0 psi)
 - The current value is also corrected.
 - Warnings C431 or C432 appear because the value 0 bar (0 psi) was assigned to the real value of 0.08 bar (1.2 psi) present and the sensor measuring range was thus exceeded by $\pm 20\%$.
- SP1 and STU values must be readjusted downwards by 0.08 bar (1.2 psi).

Damping (TAU)

Navigation

Parameter → Application → Sensor → Damping (TAU)

Description

The damping affects the speed at which the measured value reacts to changes in pressure.

Input range

0.0 to 999.9 seconds in increments of 0.1 seconds

Factory setting

2 seconds

Current output

Value for 4 mA (STL)

Navigation	Parameter → Application → Current output → Value for 4 mA (STL)
Description	Assignment of the pressure value which should correspond to the 4 mA value. It is possible to invert the current output. To do so, assign the pressure upper range value to the lower measuring current.
Note	Enter the value for 4 mA in the selected pressure unit anywhere within the measuring range. The value can be entered in increments of 0.1 (increment depends on the measuring range).
Options	No selection. The user is free to edit the values.
Factory setting	0.0 or as per order specifications

Value for 20 mA (STU)

Navigation	Parameter → Application → Current output → Value for 20 mA (STU)
Description	Assignment of the pressure value which should correspond to the 20 mA value. It is possible to invert the current output. To do so, assign the pressure lower range value to the upper measuring current.
Note	Enter the value for 20 mA in the selected pressure unit anywhere within the measuring range. The value can be entered in increments of 0.1 (increment depends on the measuring range).
Options	No selection. The user is free to edit the values.
Factory setting	Upper measuring limit or as per order specifications.

Pressure applied for 4mA (GTL)

Navigation	Parameter → Application → Current output → Pressure applied for 4mA (GTL)
-------------------	---

Description

The pressure value present is automatically adopted for the 4 mA current signal. Parameter for which the current range can be assigned to any section of the nominal range. This occurs by assigning the pressure lower range value to the lower measuring current and the pressure upper range value to the upper measuring current. The pressure lower range value and upper range value can be configured independently of one another so the pressure measuring span does not remain constant. The LRV and URV pressure measuring span can be edited over the entire sensor range. An invalid TD value is indicated by diagnostic message S510. An invalid position offset is indicated by diagnostic message C431. The editing operation cannot result in the device being operated outside the minimum and maximum sensor limits.

Incorrect entries are declined as indicated by the following messages, and the last valid value prior to the change is used again:

- Parameter value above limit (0x8031)
- Parameter value below limit (0x8032)

The measured value currently present is accepted as the value for 4mA anywhere within the measuring range. The sensor characteristic curve is shifted such that the pressure present becomes the zero value.

Pressure applied for 20mA (GTU)

Navigation

Parameter → Application → Current output → Pressure applied for 20mA (GTU)

Description

The pressure value present is automatically adopted for the 20 mA current signal. Parameter for which the current range can be assigned to any section of the nominal range. This occurs by assigning the pressure lower range value to the lower measuring current and the pressure upper range value to the upper measuring current. The pressure lower range value and upper range value can be configured independently of one another so the pressure measuring span does not remain constant. The LRV and URV pressure measuring span can be edited over the entire sensor range. An invalid TD value is indicated by diagnostic message S510. An invalid position offset is indicated by diagnostic message C431. The editing operation cannot result in the device being operated outside the minimum and maximum sensor limits. Incorrect entries are declined, and the last valid value prior to the change is used again. The measured value currently present is accepted as the value for 20 mA anywhere within the measuring range. There is a parallel shift of the sensor characteristic so that the pressure present becomes the max value.

Alarm current (FCU)

Navigation

Parameter → Application → Current output → Alarm current (FCU)

Description	<p>The device displays warnings and faults. This is done via IO-Link using the diagnostic message stored in the device. The purpose of all device diagnostics is solely to provide information to the user; they do not have a safety function. The errors diagnosed by the device are displayed via IO-Link in accordance with NE107. In accordance with the diagnostic message, the device behaves as per a warning or fault condition:</p> <p>Warning (S971, S140, C485, C431, C432): With this type of error, the device continues to measure. The output signal does not adopt its fault state (value in the event of an error). The main measured value and the state in the form of the letter plus a defined number are displayed alternately (0.5 Hz) via IO-Link. The switch outputs remain in the state defined by the switch points.</p> <p>Fault (F437, S803, F270, S510, C469, F804): With this type of error, the device does not continue to measure. The output signal adopts its fault state (value in the event of an error). The fault state is displayed via IO-Link in the form of the letter plus a defined number. The switch output changes to the defined state (open). For the analog output option, an error is also signaled and transmitted via the 4 to 20mA signal. In NE43, NAMUR defines a current ≤ 3.6 mA and ≥ 21 mA as a device failure. A corresponding diagnostic message is displayed. Current levels available for selection: The selected alarm current is used for all errors. Diagnostic messages are displayed with numbers and letter via IO-Link. It is not possible to acknowledge all the diagnostic messages. The relevant message disappears if the event is no longer pending.</p> <p>The messages are displayed in order of priority:</p> <ul style="list-style-type: none"> ■ Highest priority = first message displayed ■ Lowest priority = last message displayed
Options	<ul style="list-style-type: none"> ■ Min: Lower alarm current (≤ 3.6 mA) ■ Max: Upper alarm current (≥ 21 mA)
Factory setting	Max or as per order specifications

Switch output 1

Behavior of switch output

Switch point value/Upper value for pressure window, output 1 (SP1/FH1)
Switchback point value/Lower value for pressure window, output 1 (RP1/FL1)

Navigation

Parameter → Application → Switch output 1 → Switch point value.../Switchback point value...

Prerequisite

The following functions are available only if a hysteresis function has been configured for the switch output (output 1 (Ou1)).

Description of behavior of SP1/RP1

The hysteresis is implemented using the **SP1** and **RP1** parameters. Since the parameter settings depend on one another, the parameters are described all together. The switch point "SP1" and switchback point "RP1" can be defined with these functions (e.g. for pump control). When the set switch point "SP1" is reached (with increasing pressure), an electrical signal change takes place at the switch output. When the set switchback point "RP1" is reached (with decreasing pressure), an electrical signal change takes place at the switch output. The difference between the value of switch point "SP1" and the value of switchback point "RP1" is known as the hysteresis. The configured value for the switch point "SP1" must be greater than the switchback point "RP1". A diagnostic message is displayed if a switch point "SP1" is entered that is \leq the switchback point "RP1". While it is possible to make this entry, it does not take effect in the device. The entry must be corrected!

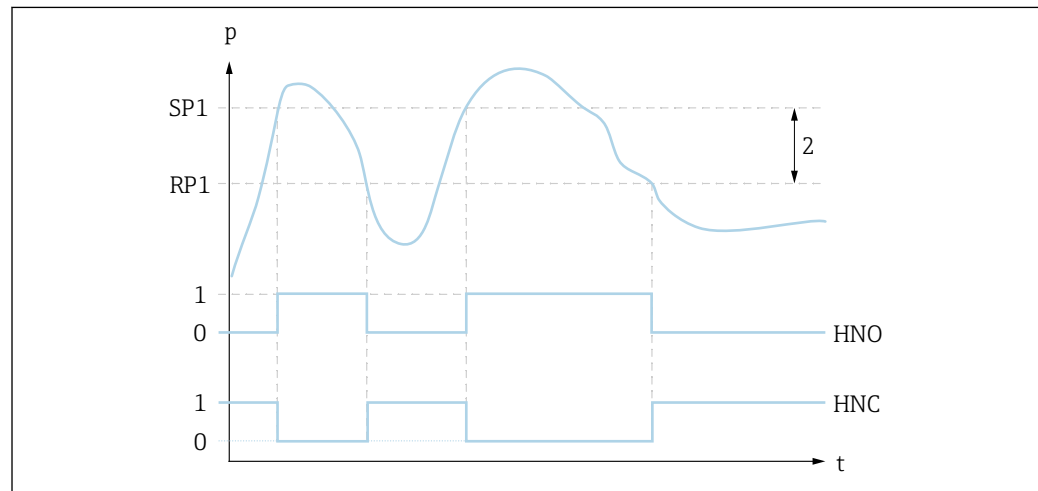

0 0-signal. Output open in quiescent state
1 1-signal. Output closed in quiescent state
2 Hysteresis
SP1 Switch point
RP1 Switchback point
HNO NO contact
HNC NC contact

i To prevent switch-on and switch-off if values are around the switch point "SP1" or switchback point "RP1", a delay can be set for the relevant points. In this regard, see the **Switching delay time, output 1 (dS1)** and **Switchback delay time, output 1 (dR1)** parameter descriptions.

Prerequisite

The following functions are available only if a window function has been configured for the switch output (output 1 (Ou1)).

Description of behavior of FH1/FL1

The window function is implemented using the **FH1** and **FL1** parameters. Since the parameter settings depend on one another, the parameters are described all together. The upper value of the pressure window "FH1" and the lower value of the pressure window "FL1" can be defined with these functions (e.g., for monitoring a certain pressure range). When the lower value of the pressure window "FL1" is reached (with increasing or decreasing pressure), an electrical signal change takes place at the switch output. When the upper value of the pressure window "FH1" is reached (with increasing or decreasing pressure), an electrical signal change takes place at the switch output. The difference between the upper value of the pressure window "FH1" and the lower value of the pressure window "FL1" is known as the pressure window. The upper value of the pressure window "FH1" must be greater than the lower value of the pressure window "FL1"! A diagnostic message is displayed if the upper value entered for the pressure window "FH1" is less than the lower value of the pressure window "FL1". While it is possible to make this entry, it does not take effect in the device. The entry must be corrected!

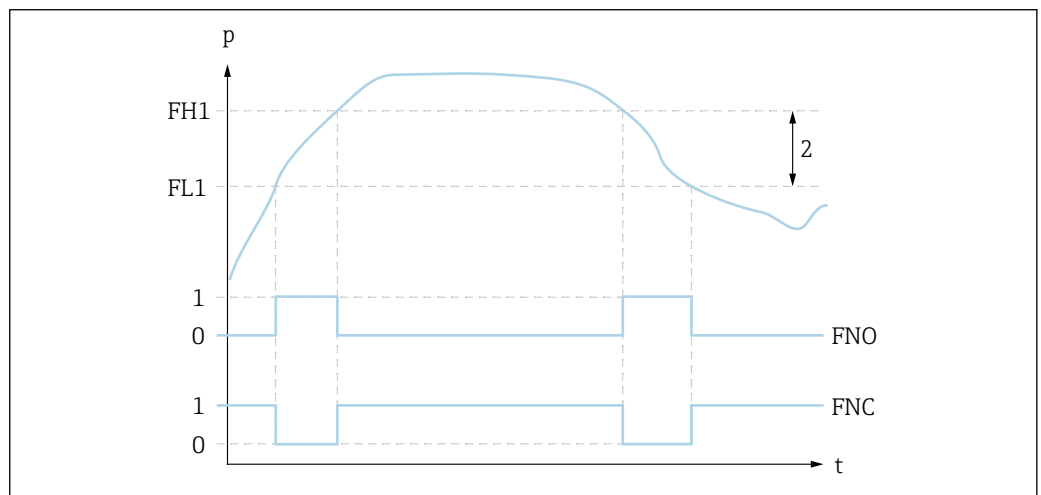

A0034026

0 0-signal. Output open in quiescent state

1 1-signal. Output closed in quiescent state

2 Pressure window (difference between the value of the high window "FH1" and the low window "FL1")

FNO NO contact

FNC NC contact

FH1 Upper value of the pressure window

FL1 Lower value of the pressure window

Options

No selection. The user is free to edit the values.

Factory setting

Factory setting (if no customer-specific setting is ordered):
Switch point SP1/FH1: 90%; switchback point RP1/FL1: 10%

*Switching delay***Switching delay time, output 1 (dS1)
Switchback delay time, output 1 (dR1)****Note**

The switching delay time/switchback delay time function is implemented using the **dS1** and **dR1** parameters. Since the parameter settings depend on one another, the parameters are described all together.

- dS1 = switching delay time, output 1
- dR1 = switchback delay time, output 1

Navigation

Parameter → Application → Switch output 1 → Switching delay.../Switchback delay...

Description

To prevent switch-on and switch-off if values are around the switch point "SP1" or the switchback point "RP1", a delay in a range of 0 – 50 seconds, to two decimal places, can be set for the individual points.

If the measured value leaves the switching range during the delay time, the delay time starts again.

Example

- SP1 = 2 bar (29 psi)
- RP1 = 1 bar (14.5 psi)
- dS1 = 5 seconds
- dR1 = 2 seconds

dS1/: ≥ 2 bar (29 psi) must be present for at least 5 seconds for SP1 to become active.
dR1/: ≥ 1 bar (14.5 psi) must be present for at least 2 seconds for RP1 to become active.

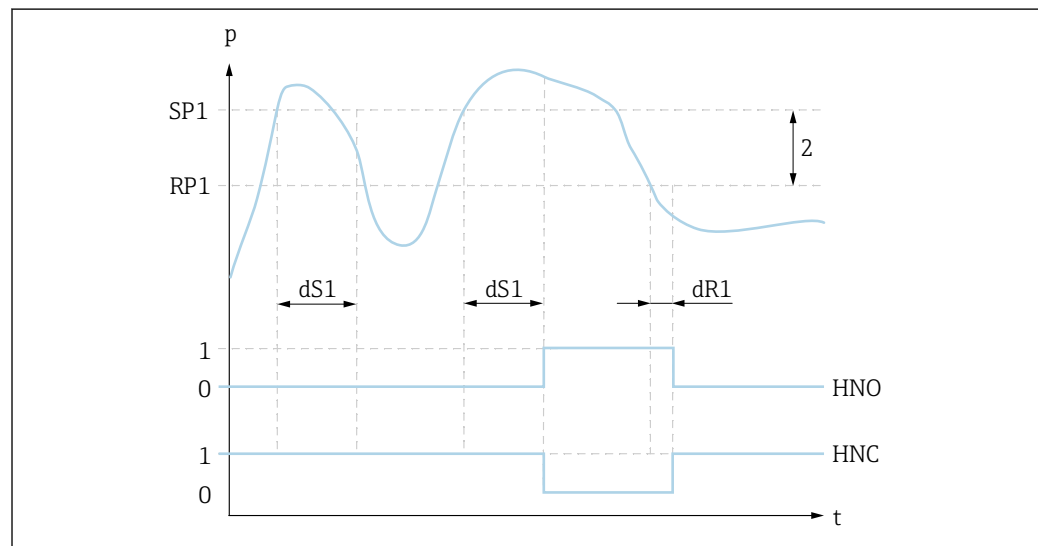

A0034027

0 0-signal. Output open in quiescent state

1 1-signal. Output closed in quiescent state

2 Hysteresis (difference between the value of the switch point "SP1" and the value of the switchback point "RP1")

HNO NO contact

HNC NC contact

SP1 Switch point 1

RP1 Switchback point 1

dS1 Set time for which the specific switch point must be reached continuously without interruption until an electrical signal change takes place

dR1 Set time for which the specific switchback point must be reached continuously without interruption until an electrical signal change takes place

Input range 0.00 - 50.00 seconds

Factory setting 0

Output 1 (OU1)

Navigation Parameter → Application → Switch output 1 → Output 1 (OU1)

Description

- Hysteresis normally open (HNO):
The switch output is specified as a NO contact with hysteresis properties.
- Hysteresis normally closed (HNC):
The switch output is specified as an NC contact with hysteresis properties.
- Window normally open (FNO):
The switch output is specified as a NO contact with window properties.
- Window normally closed (FNC):
The switch output is specified as an NC contact with window properties.

Options

- Hysteresis normally open (HNO)
- Hysteresis normally closed (HNC)
- Window normally open (FNO)
- Window normally closed (FNC)

Factory setting Hysteresis normally open (HNO) or as per order specifications

14.3.2 System

HI Max value (maximum indicator)

Navigation Parameter → System → Device Management → HI Max value (maximum indicator)

Description This parameter is used as the maximum indicator and makes it possible to call up retroactively the highest value ever measured for pressure.
A pressure that is present for at least 2.5 ms is logged to the maximum indicator. The maximum indicators cannot be reset.

LO Min value (minimum indicator)

Navigation Parameter → System → Device Management → LO Min value (minimum indicator)

Description This parameter is used as the maximum indicator and makes it possible to call up retroactively the lowest value ever measured for pressure.
A pressure that is present for at least 2.5 ms is logged to the maximum indicator. The maximum indicators cannot be reset.

Reset to factory settings (RES)

Navigation Parameter → System → Device Management → Reset to factory settings (RES)

Description  **WARNING**
"Reset to factory settings" causes an immediate reset to the factory settings of the order configuration (as-delivered state).
 If the factory settings have been changed, downstream processes might be affected following a reset (the behavior of the switch output or current output might be changed).
 ► Make sure that downstream processes are not started unintentionally.

The reset is not subject to additional locking, such as in the form of device locking. The reset also depends on the device status.

Any customer-specific configuration carried out at the factory is not affected by a reset (customer-specific configuration remains).

The following parameters are **not** reset when a reset is performed:

- LO Min value (minimum indicator)
- HI Max value (maximum indicator)
- Last Diagnostic (LST)
- Revisioncounter (RVC)

Note The last error is not reset in a reset.

Revisioncounter (RVC)

Navigation Parameter → System → Device Management → Revisioncounter (RVC)

Description Counter that indicates the number of parameter changes.

Device Access Locks.Data Storage Lock¹⁾ Activation/deactivation of data storage

1) The "Device Access Locks.Data Storage Lock" parameter is an IO-Link standard parameter. The name of the parameter may be available in the language configured in the IO-Link operating tool that is used. The display depends on the particular operating tool.

Navigation Parameter → System → Device Management → Device Access Locks.Data Storage Lock

Description The device supports data storage. If a device is being replaced, this allows the configuration of the old device to be written to the new device. If, when a device is being replaced, the original configuration of the new device is to be retained, the **Device Access Locks.Data Storage Lock** parameter can be used to prevent the parameters from being overwritten. If this parameter is set to "true", the new device does not adopt the data stored in the master's data storage.

Options

- false
- true

14.4 Observation

The process data →  21 are transmitted acyclically.

15 Accessories

15.1 Weld-in adapter

Various weld-in adapters are available for installation in vessels or pipes.

Device	Description	Option ¹⁾	Order number
PMP23	Weld-in adapter M24, d=65, 316L	PM	71041381
PMP23	Weld-in adapter M24, d=65, 316L 3.1 EN10204-3.1 material, inspection certificate	PN	71041383
PMP23	Weld-in adapter G1, 316L, conical metal joint	QE	52005087
PMP23	Weld-in adapter G1, 316L, 3.1, conical metal joint, EN10204-3.1 material, inspection certificate	QF	52010171
PMP23	Weld-in tool adapter G1, brass	QG	52005272
PMP23	Weld-in adapter G1, 316L, silicone O-ring seal	QJ	52001051
PMP23	Weld-in adapter G1, 316L, 3.1, silicone O-ring seal, EN10204-3.1 material, inspection certificate	QK	52011896
PMP23	Weld-in adapter Uni D65, 316L	QL	214880-0002
PMP23	Weld-in adapter Uni D65, 316L 3.1 EN10204-3.1 material, inspection certificate	QM	52010174
PMP23	Weld-in tool adapter Uni D65/D85, brass	QN	71114210
PMP23	Weld-in adapter Uni D85, 316L	QP	52006262
PMP23	Weld-in adapter Uni D85, 316L 3.1 EN10204-3.1 material, inspection certificate	QR	52010173

1) Product Configurator, order code for "Enclosed accessories"

If installed horizontally and weld-in adapters with a leakage hole are used, ensure that the leakage hole is pointing down. This allows leaks to be detected as quickly as possible.

15.2 Process adapter M24

The following process adapters can be ordered for the process connections with order option X2J and X3J:

Device	Description	Order number	Order number with inspection certificate 3.1 EN10204
PMP23	Varivent F DN32 PN40	52023996	52024003
PMP23	Varivent N DN50 PN40	52023997	52024004
PMP23	DIN11851 DN40	52023999	52024006
PMP23	DIN11851 DN50	52023998	52024005
PMP23	SMS 1½"	52026997	52026999
PMP23	Clamp 1½"	52023994	52024001
PMP23	Clamp 2"	52023995	52024002

15.3 M12 plug connectors

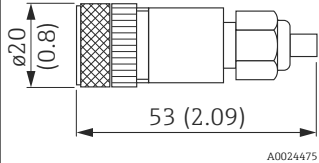
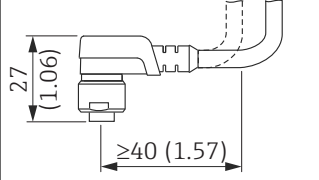
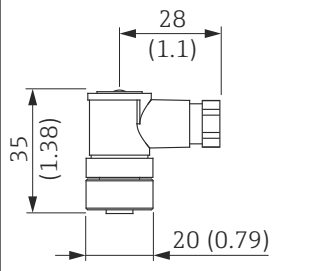
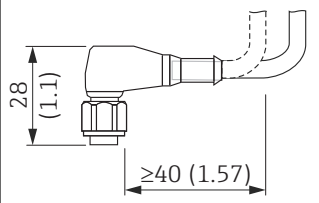
Connector	Degree of protection	Material	Option ¹⁾	Order number
<p>M12 (self-terminated connection at M12 plug)</p> 	IP67	<ul style="list-style-type: none"> ▪ Union nut: Cu Sn/Ni ▪ Body: PBT ▪ Seal: NBR 	R1	52006263
<p>M12 90 degrees with 5m (16 ft) cable</p> 	IP67	<ul style="list-style-type: none"> ▪ Union nut: GD Zn/Ni ▪ Body: PUR ▪ Cable: PVC <p>Cable colors</p> <ul style="list-style-type: none"> ▪ 1 = BN = brown ▪ 2 = WT = white ▪ 3 = BU = blue ▪ 4 = BK = black 	RZ	52010285
<p>M12 90 degrees (self-terminated connection at M12 plug)</p> 	IP67	<ul style="list-style-type: none"> ▪ Union nut: GD Zn/Ni ▪ Body: PBT ▪ Seal: NBR 	RM	71114212
<p>M12 90 degrees with 5m (16 ft) cable (terminated at one end)</p> 	IP69 ²⁾	<ul style="list-style-type: none"> ▪ Union nut: 316L (1.4435) ▪ Body and cable: PVC and PUR 	RW	52024216

- 1) Product Configurator, order code for "Enclosed accessories"
- 2) Designation of the IP protection class according to DIN EN 60529. Previous designation "IP69K" according to DIN 40050 Part 9 is no longer valid (standard withdrawn on November 1, 2012). The tests required by both standards are identical.

16 Technical data

16.1 Input

16.1.1 Measured variable

Measured process variable

Gauge pressure or absolute pressure

Calculated process variable

Pressure

16.1.2 Measuring range

Metal process isolating diaphragm

Sensor	Device	Maximum Sensor measuring range		Lowest calibratable span ¹⁾	MWP	OPL	Factory settings ²⁾	Option ³⁾
		lower (LRL)	upper (URL)					
		[bar (psi)]	[bar (psi)]					
Devices for gauge pressure measurement								
400 mbar (6 psi) ⁴⁾	PMP23	-0.4 (-6)	+0.4 (+6)	0.4 (6)	1 (15)	1.6 (24)	0 to 400 mbar (0 to 6 psi)	1F
1 bar (15 psi) ⁴⁾	PMP23	-1 (-15)	+1 (+15)	0.4 (6)	2.7 (40.5)	4 (60)	0 to 1 bar (0 to 15 psi)	1H
2 bar (30 psi) ⁴⁾	PMP23	-1 (-15)	+2 (+30)	0.4 (6)	6.7 (100.5)	10 (150)	0 to 2 bar (0 to 30 psi)	1K
4 bar (60 psi) ⁴⁾	PMP23	-1 (-15)	+4 (+60)	0.8 (12)	10.7 (160.5)	16 (240)	0 to 4 bar (0 to 60 psi)	1M
6 bar (90 psi) ⁴⁾	PMP23	-1 (-15)	+6 (+90)	2.4 (36)	16 (240)	24 (360)	0 to 6 bar (0 to 90 psi)	1N
10 bar (150 psi) ⁴⁾	PMP23	-1 (-15)	+10 (+150)	2 (30)	25 (375)	40 (600)	0 to 10 bar (0 to 150 psi)	1P
16 bar (240 psi) ⁴⁾	PMP23	-1 (-15)	+16 (+240)	5 (75)	25 (375)	64 (960)	0 to 16 bar (0 to 240 psi)	1Q
25 bar (375 psi) ⁴⁾	PMP23	-1 (-15)	+25 (+375)	5 (75)	25 (375)	100 (1500)	0 to 25 bar (0 to 375 psi)	1R
40 bar (600 psi) ⁴⁾	PMP23	-1 (-15)	+40 (+600)	8 (120)	100 (1500)	160 (2400)	0 to 40 bar (0 to 600 psi)	1S
Devices for absolute pressure measurement								
400 mbar (6 psi) ⁴⁾	PMP23	0 (0)	0.4 (+6)	0.4 (6)	1 (15)	1.6 (24)	0 to 400 mbar (0 to 6 psi)	2F
1 bar (15 psi) ⁴⁾	PMP23	0 (0)	1 (+15)	0.4 (6)	2.7 (40.5)	4 (60)	0 to 1 bar (0 to 15 psi)	2H
2 bar (30 psi) ⁴⁾	PMP23	0 (0)	2 (+30)	0.4 (6)	6.7 (100.5)	10 (150)	0 to 2 bar (0 to 30 psi)	2K
4 bar (60 psi) ⁴⁾	PMP23	0 (0)	4 (+60)	0.8 (12)	10.7 (160.5)	16 (240)	0 to 4 bar (0 to 60 psi)	2M
10 bar (150 psi) ⁴⁾	PMP23	0 (0)	10 (+150)	2 (30)	25 (375)	40 (600)	0 to 10 bar (0 to 150 psi)	2P
40 bar (600 psi) ⁴⁾	PMP23	0 (0)	+40 (+600)	8 (120)	100 (1500)	160 (2400)	0 to 40 bar (0 to 600 psi)	2S

- 1) Highest turn down that can be set at the factory: 5:1. The turn down is preset and cannot be changed.
- 2) Other measuring ranges (e.g. -1 to +5 bar (-15 to 75 psi)) can be ordered with customer-specific settings (see the Product Configurator, order code for "Calibration; Unit" option "J"). It is possible to invert the output signal (LRV = 20 mA; URV = 4 mA). Prerequisite: URV < LRV
- 3) Product Configurator, order code for "Sensor range"
- 4) Vacuum resistance: 0.01 bar (0.145 psi) abs

Maximum turn down which can be ordered for absolute pressure and gauge pressure sensors

Device	Range	400 mbar (6 psi)	1 bar (15 psi) 6 bar (90 psi) 16 bar (240 psi)	2 bar (30 psi) 4 bar (60 psi) 10 bar (150 psi) 25 to 40 bar (375 to 600 psi)
PMP23	0.3%	TD 1:1	TD 1:1 to TD 2.5:1	TD 1:1 to TD 5:1

16.2 Output

16.2.1 Output signal

Designation	Option ¹⁾
IO-Link 4 to 20 mA (3-wire or 4-wire)	7

1) Product Configurator, order code for "Output"

16.2.2 Switching capacity

- Switch status ON: $I_a \leq 200 \text{ mA}$ ^{3) 4)}; switch status OFF: $I_a \leq 1 \text{ mA}$
- Switch cycles: >10,000,000
- Voltage drop PNP: $\leq 2 \text{ V}$
- Overload protection: Automatic load testing of switching current;
 - Max. capacitive load: 1 μF at max. supply voltage (without resistive load)
 - Max. cycle duration: 0.5 s; min. t_{on} : 40 μs
 - Periodic disconnection from protective circuit in the event of overcurrent ($f = 2 \text{ Hz}$) and "F804" displayed

16.2.3 Signal range 4 to 20 mA

3.8 mA to 20.5 mA

16.2.4 Load (for 4 to 20 mA devices)

In order to guarantee sufficient terminal voltage, a maximum load resistance R_L (including line resistance) must not be exceeded depending on the supply voltage U_B of the supply unit.

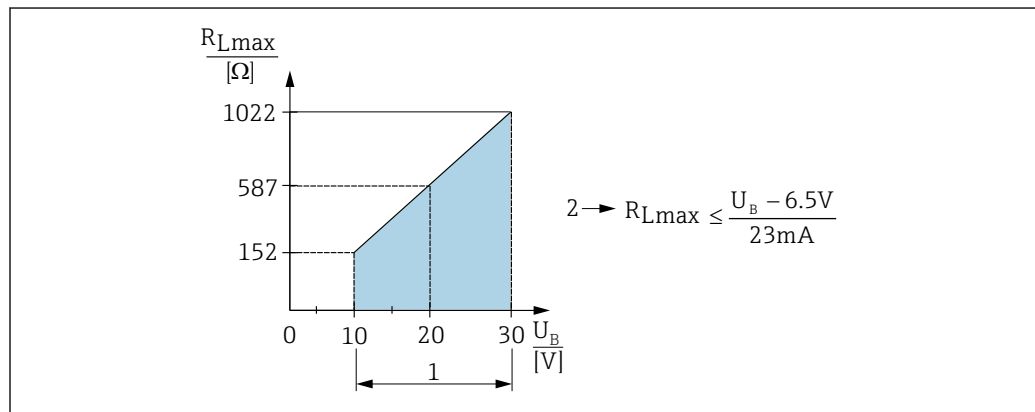

- 1 Power supply 10 to 30 V DC
 2 R_{Lmax} Maximum load resistance
 U_B Supply voltage

- Error current is output and "S803" displayed (output: MIN alarm current)
- Periodic checking to establish if it is possible to quit fault state

3) 100 mA can be guaranteed over the entire temperature range for the switch output 1 x PNP + 4 to 20 mA output. For lower ambient temperatures, higher currents are possible but cannot be guaranteed. Typical value at 20 °C (68 °F) approx. 200 mA. 200 mA can be guaranteed over the entire temperature range for the "1 x PNP" switch output.
 4) Larger currents are supported, thus deviating from the IO-Link standard.

16.2.5 Signal on alarm 4 to 20 mA

The response of the output to error is regulated in accordance with NAMUR NE43.

Factory setting MAX alarm: >21 mA

alarm current

Device	Description	Option
PMP23	Adjusted min. alarm current	IA ¹⁾

1) Product Configurator order code for "Service"

16.2.6 Dead time, time constant

Presentation of the dead time and the time constant:

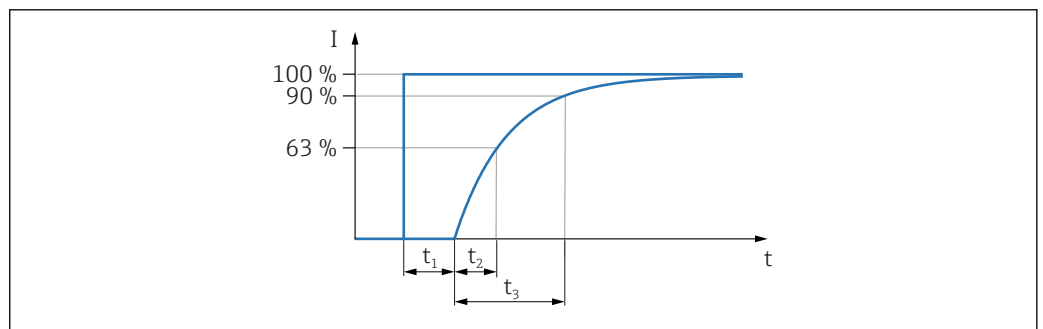

A0019786

16.2.7 Dynamic behavior

Dead time (t_1) [ms]	Time constant (T63), t_2 [ms]	Time constant (T90), t_3 [ms]
7 ms	11 ms	16 ms

16.2.8 Dynamic behavior of switch output

Response time ≤ 20 ms

16.3 Performance characteristics of metal process isolating diaphragm

16.3.1 Reference operating conditions

- As per IEC 60770
- Ambient temperature T_A = constant, in the range: +21 to +33 °C (+70 to +91 °F)
- Humidity φ = constant, in the range: 5 to 80 % rH
- Ambient pressure p_A = constant, in the range: 860 to 1 060 mbar (12.47 to 15.37 psi)
- Position of measuring cell = constant, in the range: horizontal $\pm 1^\circ$ (see also "Influence of the installation position" section →  14)
- Zero based span
- Process isolating diaphragm material: AISI 316L (1.4435)
- Filling oil: synthetic oil polyalphaolefin FDA 21 CFR 178.3620, NSF H1
- Supply voltage: 24 V DC ± 3 V DC
- Load: 320 Ω (at 4 to 20 mA output)

16.3.2 Measuring uncertainty for small absolute pressure measuring ranges

The smallest extended uncertainty of measurement that can be delivered by our standards is:

- in the range 1 to 30 mbar (0.0145 to 0.435 psi): 0.4 % of reading
- in the range < 1 mbar (0.0145 psi): 1 % of reading.

16.3.3 Influence of the installation position

→  14

16.3.4 Resolution

Current output: min. 1.6 μ A

16.3.5 Reference accuracy

The reference accuracy contains the non-linearity [DIN EN 61298-2 3.11] including the pressure hysteresis [DIN EN 61298-23.13] and non-repeatability [DIN EN 61298-2 3.11] in accordance with the limit point method as per [DIN EN 60770].

Device	% of the calibrated span to the maximum turn down		
	Reference accuracy	Non-linearity	Non-repeatability
PMP23	± 0.3	± 0.1	± 0.1

Overview of the turn down ranges →  61

16.3.6 Thermal change of the zero output and the output span

PMP23

Measuring cell	-20 to +85 °C (-4 to +185 °F)		-40 to -20 °C (-40 to -4 °F) +85 to +100 °C (+185 to +212 °F)	
	% of the calibrated span for TD 1:1			
<1 bar (15 psi)	<1	<1.2	<1	<1
≥ 1 bar (15 psi)	<0.8	<1	<1	<1

16.3.7 Long-term stability

Device	1 year	5 years	8 years
	% of URL		
IO-Link	±0.2	±0.4	±0.45

16.3.8 Switch-on time

≤2 s

For small measuring ranges, pay attention to the thermal compensation effects.

16.4 Environment

16.4.1 Ambient temperature range

Device	Ambient temperature range ¹⁾
PMP23	-40 to +70 °C (-40 to +158 °F)
PMP23	Devices for hazardous areas: -40 to +70 °C (-40 to +158 °F)

- 1) Exception: the following cable is designed for an ambient temperature range of -25 to +70 °C (-13 to +158 °F): Product Configurator order code for "Enclosed accessories" option "RZ".

16.4.2 Storage temperature range

-40 to +85 °C (-40 to +185 °F)

16.4.3 Climate class

Device	Climate class	Note
PMP23	Class 4K4H	Air temperature: -20 to +55 °C (-4 to +131 °F), relative humidity: 4 to 100 % satisfied according to DIN EN 60721-3-4 (condensation is possible)

16.4.4 Degree of protection

Device	Connection	Degree of protection	Option ¹⁾
PMP23	M12 plug	IP65/67 NEMA type 4X enclosure	M
PMP23	M12 plug made of metal	IP66/69 ²⁾ NEMA type 4X enclosure	N

- 1) Product Configurator order code for "Electrical connection"
 2) Designation of the IP protection class according to DIN EN 60529. Previous designation "IP69K" according to DIN 40050 Part 9 is no longer valid (standard withdrawn on November 1, 2012). The tests required by both standards are identical.

16.4.5 Vibration resistance

Test standard	Vibration resistance
IEC 60068-2-64:2008	Guaranteed for 5 to 2000Hz: 0.05g ² /Hz

16.4.6 Electromagnetic compatibility

- Interference emission as per EN 61326-1 equipment B
- Interference immunity as per EN 61326-1 (industrial environment)
 Devices with IO-Link: For intended use, the switch output can switch to the communication mode for 0.2 s in the event of transient faults (only for devices with IO-Link).
- Maximum deviation: 1.5% with TD 1:1

For more details please refer to the Declaration of Conformity.

16.5 Process

16.5.1 Process temperature range for devices with metallic process isolating diaphragm

Device	Process temperature range
PMP23	-10 to +100 °C (+14 to +212 °F)
PMP23 Sterilization in place (SIP)	At +135°C (+275 °F) for a maximum of one hour (device in operation but not within measuring specification)

Applications with changes in temperature

Frequent extreme changes in temperatures can temporarily cause measuring errors. Internal temperature compensation is faster the smaller the change in temperature and the longer the time interval.

For further information please contact your local Endress+Hauser Sales Center.

16.5.2 Pressure specifications

WARNING

The maximum pressure for the measuring device depends on the lowest-rated element with regard to pressure.

- ▶ For pressure specifications, see the "Measuring range" section and "Mechanical construction" section in the Technical Information.
- ▶ The Pressure Equipment Directive (2014/68/EU) uses the abbreviation "PS". The abbreviation "PS" corresponds to the MWP (maximum working pressure) of the measuring device.
- ▶ MWP (maximum working pressure): The MWP (maximum working pressure) is specified on the nameplate. This value is based on a reference temperature of +20 °C (+68 °F) and may be applied to the device for an unlimited period of time. Observe the temperature dependency of the MWP.
- ▶ OPL (over pressure limit): The test pressure corresponds to the over pressure limit of the sensor and may only be applied temporarily to ensure that the measurement is within the specifications and no permanent damage develops. In the case of sensor range and process connections where the over pressure limit (OPL) of the process connection is smaller than the nominal value of the sensor, the device is set at the factory, at the very maximum, to the OPL value of the process connection. If you want to use the entire sensor range, select a process connection with a higher OPL value.

Index

A

Actual Diagnostics (STA)	44
Alarm current (FCU)	50
Application	8
Application Specific Tag	44

C

CE mark (declaration of conformity)	9
Cleaning	41
Configuration of a pressure measurement	25
Configuring pressure measurement	25

D

Damping (TAU)	48
Declaration of Conformity	9
Designated use	8
Device Access Locks.Data Storage Lock (activation/ deactivation of data storage)	57
Diagnostic event	38
Diagnostic events	38
Diagnostic message	38
Diagnostics Symbols	38
Disposal	42

E

ENP_VERSION	44
Event text	38
Extended ordercode	44
Exterior cleaning	41

F

Field of application Residual risks	8
--	---

H

HI Max value (maximum indicator)	56
Hysteresis	30, 52

I

In alarm condition	38
------------------------------	----

L

Last Diagnostic (LST)	44
LO Min value (minimum indicator)	56

M

Maintenance	41
Media	8
Menu Description of device parameters	44
Overview	43

N

Nameplate	12
---------------------	----

O

Operating menu Description of device parameters	44
Overview	43
Operating Mode (FUNC)	33, 46
Operational safety	9
Output 1 (OU1)	33, 55

P

Pressure applied for 4mA (GTL)	34, 49
Pressure applied for 20mA (GTU)	34, 50
Product safety	9

R

Repair concept	42
Reset to factory settings (RES)	56
Revisioncounter (RVC)	56

S

Safety instructions Basic	8
Simulation Current Output (OU2)	45
Simulation Switch Output 1 (OU1)	45
Staff Requirements	8
Status signals	38
Switch point value/Upper value for pressure window, output 1 (SP1/FH1)	30, 52
Switchback delay time, output 1 (dR1)	32, 54
Switchback point value/Lower value for pressure window, output 1 (RP1/FL1)	30, 52
Switching delay time, output 1 (dS1)	32, 54

T

Troubleshooting	37
---------------------------	----

U

Unit changeover (UNI) - μ C-temperature	46
Using measuring device Borderline cases	8
Incorrect use	8
see Designated use	

V

Value for 4 mA (STL)	33, 49
Value for 20 mA (STU)	34, 49

W

Window function	30, 52
Workplace safety	9

Z

Zero point adoption (GTZ)	27, 47
Zero point configuration (ZRO)	27, 46



71440622

www.addresses.endress.com
