

Operating Instructions **Minicap FTC262**

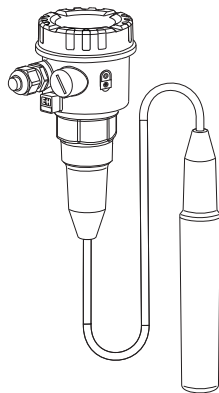

DE- Grenzschalter

EN- Point Level Switch

FR- Détecteur de niveau

ES- Detector de nivel

IT- Interruttore di livello

NL- Niveauschakelaar

de - Inhalt

Sicherheitshinweise	4
Identifikation	6
Einbau	7
Einstellungen	11
Funktionsoptimierung	12
Anschluss	14
Funktion	17
Wartung	19
Fehlersuche	21
Ergänzende Dokumentation	27

en - Contents

Safety instructions	4
Identification	6
Mounting	7
Setting-up	11
Optimising Performance	12
Connections	14
Function	17
Maintenance	19
Trouble-shooting	22
Supplementary documentation	27

fr - Sommaire

Conseils de sécurité	4
Dénomination	6
Montage	7
Réglage	11
Optimisation de fonction	12
Raccordement	14
Fonction	17
Entretien	19
Recherche de défauts	23
Documentation complémentaire	27



Tipp



Erlaubt



Verboten



Sichtkontrolle



Tip



Allowed



Forbidden



Visual check



Tuyau



Permis



Interdit



Contrôle visuel

Lichtsignale LED

grün (gn): Betrieb
gelb (ye): Schaltzustand
rot (rd): Störung

Light signals LED

green (gn): Working
yellow (ye): Switch status
red (rd): Fault

Signaux lumineux LED

verte (gn): Fonctionnement
jaune (ye): Etat de commutation
rouge (rd): Défaut

es - Índice

Notas sobre seguridad	4
Identificación	6
Montaje	7
Ajuste	11
Optimización del funcionamiento	12
Conexiones	14
Funcionamiento	17
Mantenimiento	19
Identificación de fallos	24
Documentación suplementaria	27

it - Índice

Note sulla sicurezza	4
Identificazione	6
Montaggio	7
Messa in marcia	11
Ottimizzazione delle prestazioni	12
Collegamenti	14
Funzione	17
Manutenzione	19
Individuazione e eliminazione delle anomalie	25
Documentazione supplementare	27

nl - Inhoud

Veiligheidsinstructies	4
Identificatie	6
Montage	7
Instellingen	11
Funcieoptimalisatie	12
Aansluiting	14
Funcie	17
Onderhoud	19
Fout zoeken	26
Aanvullende documentatie	27



Consejo



Permitido



Prohibido



Control visual



Tip



Permesso



Proibito



Controllo visivo



Tip



Toegestaan



Verboden



visuele controle

Señales luminosas LED

verde (gn): En servicio
amarillo (ye): Estado de
conmutación
rojo (rd): Fallo

Segnali luminosi LED

verde (gn): Funzionamento
giallo (ye): Stado di commutazione
rosso (rd): Guasto

Lichtsignalen LED

groen (gn): In bedrijf
geel (ye): Schakeltoestand
rood (rd): Fout

de - Sicherheitshinweise

Der Minicap FTC262 darf nur als Grenzschalter für feinkörnige Schüttgüter verwendet werden.

Bei unsachgemäßem Einsatz können Gefahren von ihm ausgehen.

Das Gerät darf **nur von qualifiziertem und autorisiertem Fachpersonal**

unter Beachtung dieser

Betriebsanleitung,

der einschlägigen Normen,

der gesetzlichen Vorschriften

und der Zertifikate (je nach

Anwendung) eingebaut,

angeschlossen, in Betrieb

genommen und gewartet werden.

In der Gebäudeinstallation ist ein

Netzschalter für das Gerät leicht

erreichbar in dessen Nähe zu

installieren.

Der Schalter ist als Trenn-

vorrichtung für das Gerät zu

kennzeichnen.

en - Notes on Safety

The Minicap FTC262 may be used as a point level switch in light bulk solids.

If used incorrectly, it can be a source of dangers.

The device may be installed, connected, commissioned, operated and maintained **by qualified and authorised personnel only**, under

compliance with these Operating Instructions, the relevant standards, legal requirements, and certificates (depending on the application).

Install an easily accessible power switch in the proximity of the device. Mark the power switch as a disconnecter for the device.

fr - Conseils de sécurité

Le Minicap FTC262 doit être exclusivement utilisé comme détecteur de niveau pour matériaux en vrac à grains fins.

Il peut être source de danger en cas d'utilisation non conforme aux prescriptions.

L'appareil ne doit être installé, raccordé, mis en service et entretenu **que par un personnel qualifié et autorisé**, qui tiendra compte des instructions du présent manuel de mise en service, des normes en vigueur, des directives légales et des certificats disponibles (selon l'application).

Installer un commutateur réseau à proximité immédiate de l'appareil, en veillant à ce qu'il soit facilement accessible. Marquer ce commutateur comme prise de coupure de l'appareil.

es - Notas sobre seguridad

El detector de nivel Minicap FTC262 sólo debe utilizarse para la detección de límite en materiales de grano fino.

Su empleo inapropiado puede resultar peligroso. El equipo deberá ser montado, conectado, instalado y mantenido **única y**

exclusivamente por personal cualificado y autorizado,

bajo observación de las presentes instrucciones de servicio, de las normativas y legislaciones vigentes, así como de los certificados (dependiendo de la aplicación).

Instalar un interruptor de fácil acceso en las proximidades del equipo. Identificar el interruptor como desconector del equipo.

it - Note sulla sicurezza

Il Minicap FTC262 deve essere esclusivamente utilizzato come interruttore di livello per rinfusa a grana fine.

Un utilizzo non corretto può determinare pericolo.

Lo strumento può essere montato **solamente da personale qualificato ed autorizzato.**

Il montaggio, il collegamento, la messa in esercizio e la manutenzione devono rispettare le presenti istruzioni, le norme vigenti e i certificati (a seconda dell'applicazione).

Installare un interruttore per l'alimentazione in prossimità del dispositivo. Marcare l'interruttore come disconnessione del dispositivo.

nl - Veiligheidsinstructies

Gebruik de Minicap FTC262 alleen als niveauschakelaar voor in fijnkorrelige materialen.

Indien niet correct gebruikt kunnen gevaarlijke situaties ontstaan.

Het instrument **alleen door gekwalificeerd en**

geautoriseerd personeel laten inbouwen, aansluiten, in bedrijf nemen en onderhouden.

Neem de instructies in deze Inbedrijfstellingsvoorschriften, de desbetreffende normen, de wettelijke voorschriften en eventuele certificaten in acht.

Installeer een makkelijk bereikbare voedingschakelaar in de nabijheid van het instrument. Kenmerk de voedingschakelaar specifiek voor het instrument.

de - Identifikation

Folgende Möglichkeiten stehen zur Identifizierung des Messgeräts zur Verfügung:

- Typenschildangaben
- Bestellcode (Order code) mit Aufschlüsselung der Gerätemerkmale auf dem Lieferschein

fr - Dénomination

Les options suivantes sont disponibles pour l'identification de l'appareil:

- Indications de la plaque signalétique
- Référence de commande (Order code) avec énumération des caractéristiques de l'appareil sur le bordereau de livraison

it - Identificazione

Per l'identificazione del misuratore sono disponibili le seguenti opzioni:

- dati della targhetta
- codice d'ordine con lista delle caratteristiche del dispositivo sul documento di trasporto

en - Identification

The following options are available for identification of the measuring device:

- Nameplate specifications
- Order code with breakdown of the device features on the delivery note

es - Identificación

Las opciones siguientes están disponibles para la identificación del dispositivo de medición:

- Especificaciones de la placa de identificación
- Código de pedido con desglose de las características del dispositivo en el albarán de entrega

nl - Identificatie

De volgende mogelijkheden bestaan om het meetinstrument te identificeren:

- specificaties op de typeplaat
- codice d'ordine con lista delle caratteristiche del dispositivo sul documento di trasporto

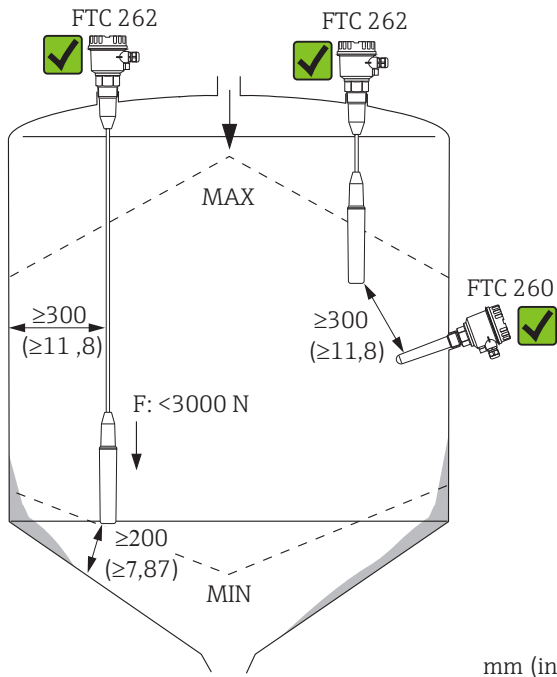

de - Einbau

Einbaubeispiele

en - Mounting

Mounting Examples

fr - Montage

Exemples de montage

es - Montaje

Ejemplos de montaje

it - Montaggio

Esempi di montaggio

nl - Inbouw

Inbouwvoorbeelden

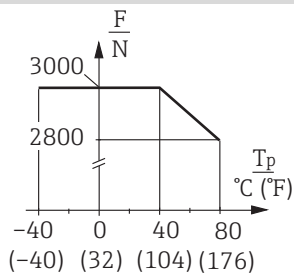

de - Falscher Einbau
en - Incorrect Mounting
fr - Montage incorrect
es - Montaje incorrecto
it - Montaggio errato
nl - Foutieve inbouw

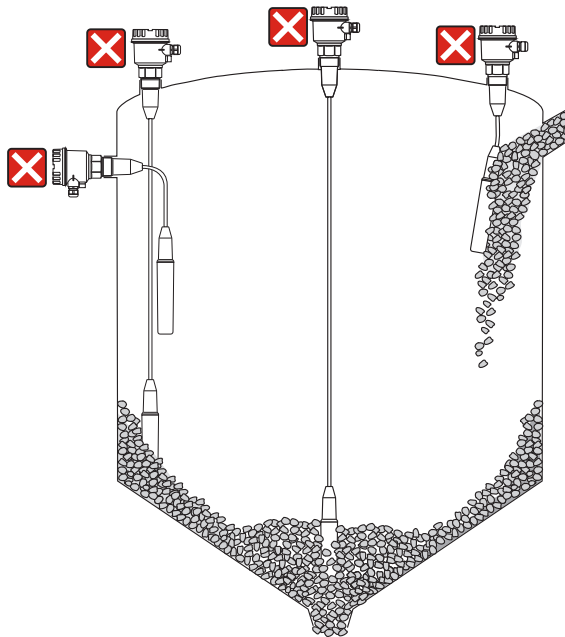

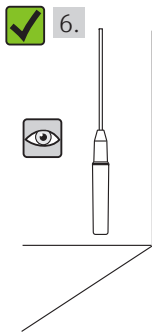
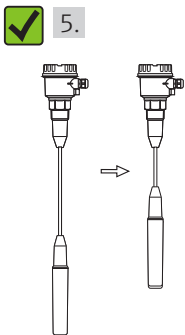
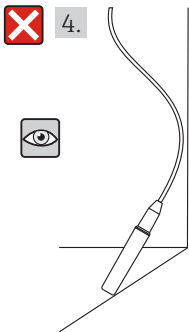
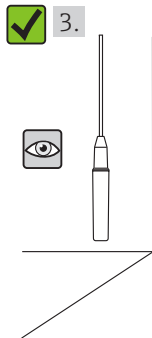
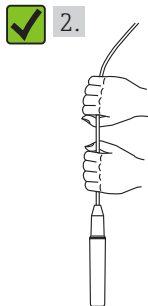
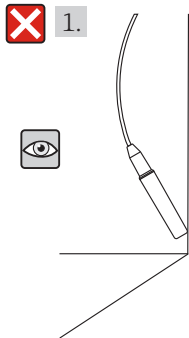

1., 2., 3.

de – Seil gerade biegen

en – Straightening the rope

fr – Redresser le câble

es – Enderece el cable

it – Raddrizzare la fune

nl – Kabel recht buigen

4., 5., 6.

de – Seilkürzung siehe “Zubehör”

en – For rope shortening see
“Accessories”

fr – Raccourcissement du câble voir
“Accessoires”

es – Para acortar el cable, vea
“Accesorios”

it – Per accorciare la fune
v. “Accessori”

nl – Kabel inkorten zie “Accessoires”

- de** - Minicap in den Prozessanschluss
einschrauben.
Nicht am Gehäuse drehen.
- en** - Screw Minicap into process
connection.
Don't use housing to turn!
- fr** - Visser le Minicap.
Ne pas se servir du boîtier!
- es** - Rescar el Minicap a la conexión a
proceso.
No girar el cabezal!
- it** - Avvitare il Minicap all'attacco al
processo.
Non avvitarlo della custodia!
- nl** - Schroef de Minicap in de
procesaansluiting.
Draai hierbij niet aan de behuizing!

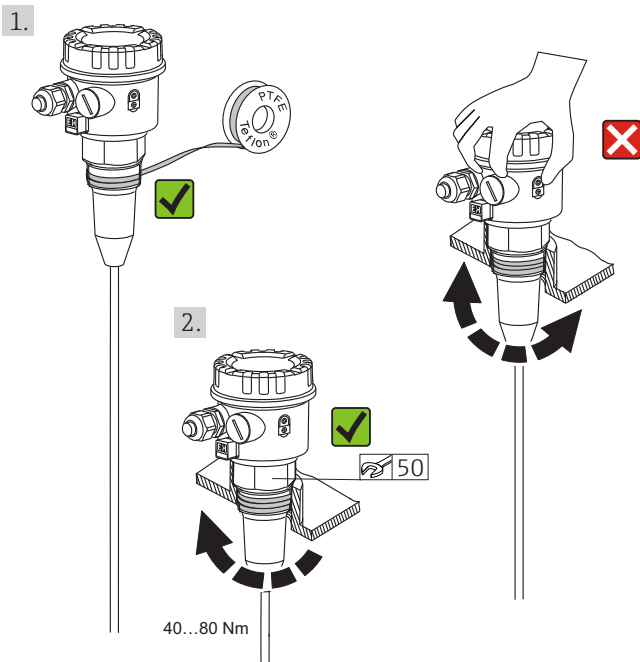

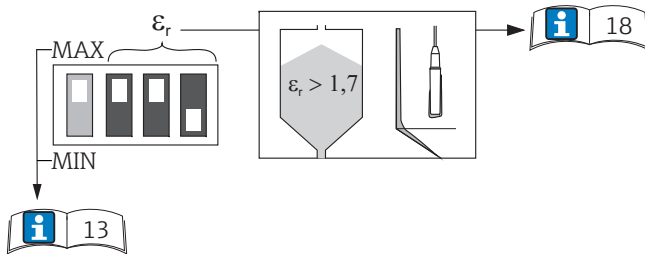
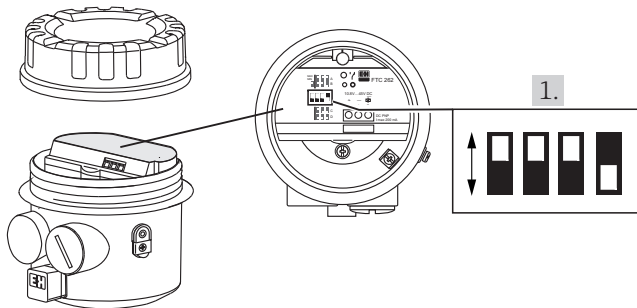

de - Einstellungen
 en - Setting-up
 fr - Réglage
 es - Ajuste
 it - Messa in marcia
 nl - Instellingen

1. Werkseinstellung
1. Factory settings
1. Réglages usine
1. Ajustes de fábrica
1. Impostazione di fabbrica
1. Fabrieksinstelling

de - Funktionsoptimierung ϵ_r

Eine Änderung der Schalterstellung ϵ_r ist nur unter folgenden Bedingungen zu empfehlen:

– bei Neigung zur starker Ansatzbildung an der Sonde

– bei sehr kleiner

Dielektrizitätszahl ϵ_r .

Einstellung siehe Tabelle auf Seite 18.

en - Optimising Performance ϵ_r

The switch setting ϵ_r should be changed only if the following conditions are met:

– tendency to heavy build-up on the probe

– very low dielectric constant ϵ_r .

The appropriate settings are shown in the table on page 18.

fr - Optimisation de fonction ϵ_r

Une modification de la position ϵ_r du commutateur est seulement recommandée dans les cas suivants:

– dépôt important sur la sonde

– très faible coefficient diélectrique ϵ_r .

Réglage voir tableau page 18.

es - Optimización del funcionamiento ϵ_r

El ajuste del interruptor ϵ_r sólo deberá variarse si se dan las siguientes condiciones:

– tendencia a producirse fuertes adherencias en la sonda

– constante dieléctrica ϵ_r muy baja.

En la tabla de la pág. 18 se indica e ajuste adecuado.

it - Ottimizzazione delle prestazioni ϵ_r

L'impostazione del interruttore ϵ_r dovrebbe essere cambiata solo in presenza delle condizioni sotto elencate:

– tendenza a consistenti depositi sulla sonda

– costante dielettrica troppo bassa ϵ_r .

L'appropriata impostazione è mostrata nella tabella a pag. 18.

nl - Functieoptimalisatie ϵ_r

De schakelstand ϵ_r alleen wijzigen bij de volgende condities:

– neiging tot aangroei op de elektrode

– bij zeer lage diëlectrische constante ϵ_r .

De juiste instelling wordt getoond op pag. 18.

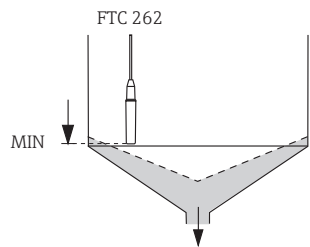
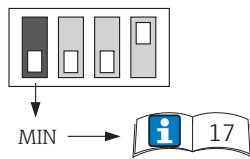
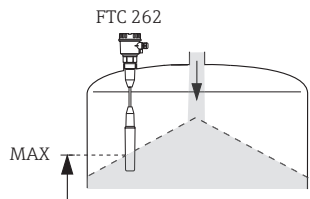
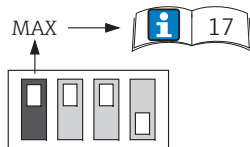

- de** - Sicherheitsschaltung wählen
- en** - Setting fail-safe mode
- fr** - Choisir la commutation de sécurité
- es** - Ajuste del modo de seguridad
- it** - Impostare la modalità di sicurezza
- nl** - Kies fail-safe instelling (ruststroomprincipe)

de - Anschluss

Nationale Normen und
Vorschriften beachten!

en - Connections

Note all regulations
and standards!

fr - Raccordement

Respecter les lois et règles
locales en vigueur!

es - Conexiones

¡Considere reglamentaciones
nacionales!

it - Collegamenti

Osservare le norme nazionali!

nl - Aansluiting

Nationale voorschriften
in acht nemen!

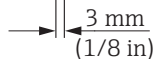
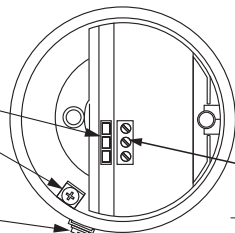
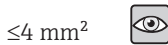
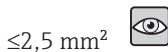
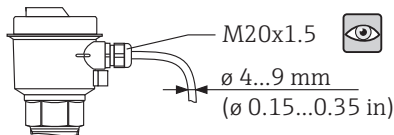

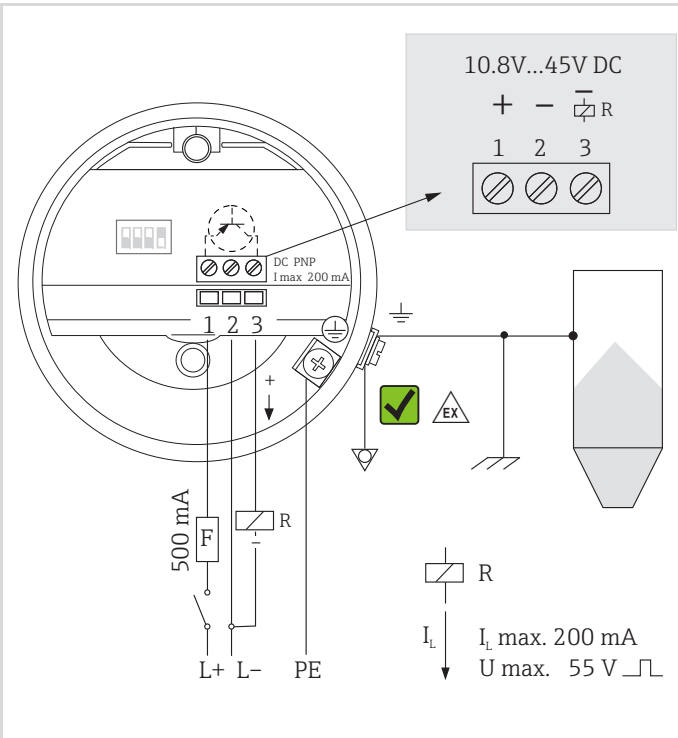

FTC262 - ###2##

- de** - Gleichstromanschluss
Transistorausgang PNP
R: Externe Last
- en** - DC connection
Transistor output PNP
R: External load
- fr** - Raccordement Courant continu
Sortie transistor PNP
R: Charge extérieure
- es** - Alimentación CC
Salida transistor PNP
R: Carga exterior
- it** - Collegamento CC
Uscita a transistori PNP
R: Carico esterno
- nl** - Gelijkspanningsaansluiting
transistoruitgang PNP
R: Externe belasting

FTC262 - ###4##

de - Allstromanschluss
Relaisausgang

en - Universal connection
Relay output









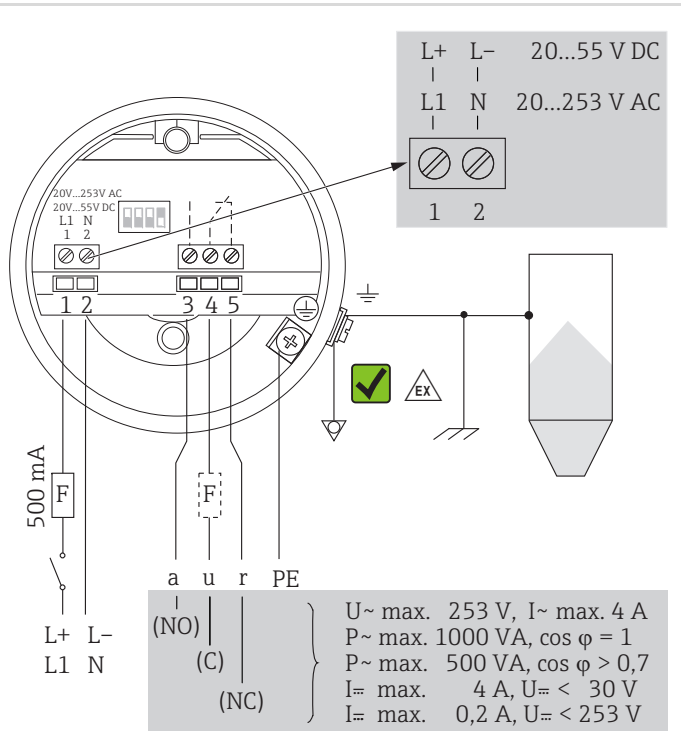



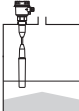

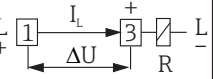

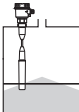

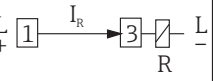

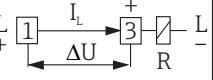

fr - Raccordement tous courants
Sortie relais

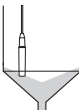
es - Alimentación universal
Salida por relé

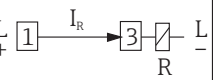
it - Collegamento corrente universale
Uscita relè

nl - Universele spanningsaansluiting
Relaisuitgang

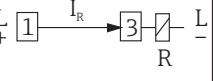

S		GN	RD	U = DC	U = AC/DC
				 PNP	 Relais
					
MAX ↑					
					
MIN ↓					
					

de - Funktion

Sicherheitsschaltung wählen

en - Function

Setting fail-safe mode

fr - Fonction

Choisir la commutation de sécurité

es - Funcionamiento

Ajuste del modo de seguridad

it - Funzione



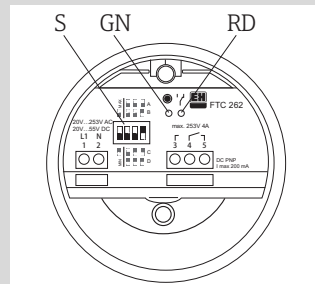

Impostare la modalità di sicurezza

nl - Functie

Kies fail-safe instelling
(ruststroomprincipe)

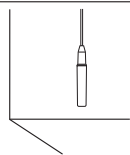

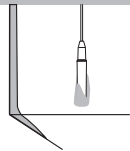
- de** - Einstellungen zur Funktionsoptimierung
- wenn erforderlich -
- en** - Settings to optimise performance
- if required -
- fr** - Réglages pour optimisation de fonction
- si nécessaire-
- es** - Ajustes para optimizar el funcionamiento
- en caso necesario -
- it** - Impostazione per ottimizzare le prestazioni
- se necessario -
- nl** - Instellingen voor optimalisatie
- indien gewensd -

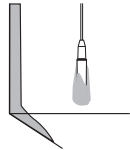
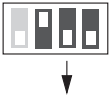
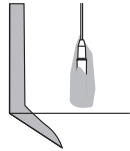
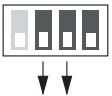
Getreide Grain Céréales Grano Graan				
$*\epsilon_r$	g/l (min.)	$*\epsilon_r > 1,5$		
> 1,5	200	$*\epsilon_r > 1,7$		
> 1,7	250	$*\epsilon_r > 2,0$		
> 2,0	400	$*\epsilon_r > 3,0$		
> 3,0	800			
Mineralien, Kunststoffe Minerals, Plastics Minéraux, Plastiques Minerales, plásticos Minerali, plastiche Mineralen, Kunststoffen				
$*\epsilon_r$	g/l (min.)	$*\epsilon_r > 1,5$		
> 1,5	500			
> 1,7	700			
> 2,0	1100			

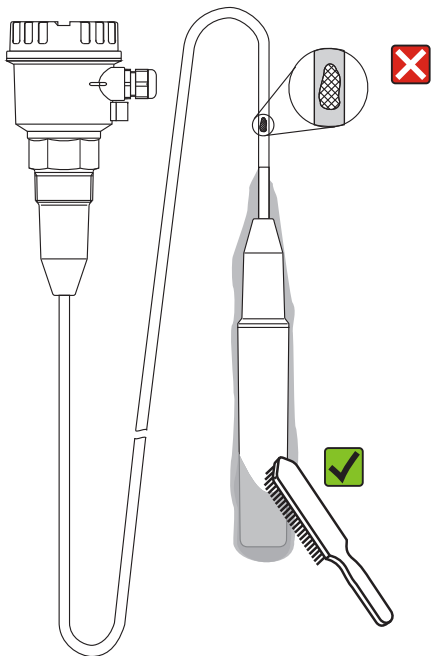

de - Wartung

Seil prüfen
Anbackungen entfernen

en - Maintenance

Check rope
Removal of encrustation

fr - Entretien

Contrôler le câble
Enlever les incrustations

es - Mantenimiento

Comprobar el cable
Eliminación de adherencias

it - Manutenzione

Controllare il cavo
Rimozione dei depositi

nl - Onderhoud

Kabel controleren
Aangroei verwijderen

- de** - Umgebungstemperatur T_a
 Betriebstemperatur T_p
 Druck p_e
- en** - Ambient temperature T_a
 Process temperature T_p
 Process pressure p_e
- fr** - Température ambiante T_a
 Température de service T_p
 Pression de service p_e
- es** - Temperatura ambiente T_a
 Temperatura de trabajo T_p
 Presión de trabajo p_e
- it** - Temperatura ambiente T_a
 Temperatura d'esercizio T_p
 Pressione d'esercizio p_e
- nl** - Omgevingstemperatuur T_a
 Procestemperatuur T_p
 Procesdruk p_e

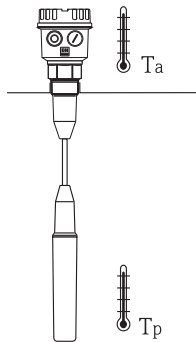

$p_e = -1...+6$ bar
 (-14.5...+90 psi)

ϵ_r min. 1,5

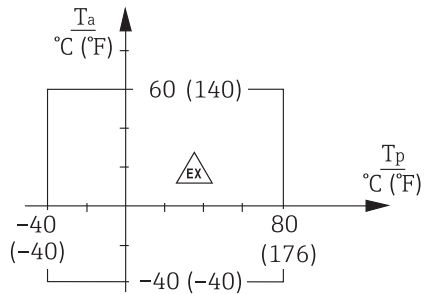
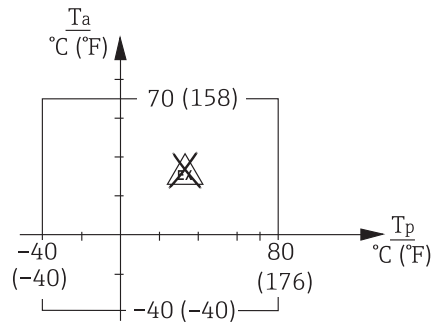
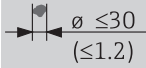

Fehlfunktion	Ursache	Maßnahme
Schaltet nicht	Versorgungsspannung fehlt (Grüne Leuchtdiode aus)	Versorgung prüfen
	Dielektrizitätszahl ϵ_r des Schüttguts zu gering	Am Elektronikeinsatz Schalterstellung ändern
	Schlechte Masseverbindung	Erdungsanschluss vom Gehäuse zum Behälter oder zu Metallteilen prüfen
	Sonde berührt Behälterwand	Seil gerade biegen
	Sonde berührt Auslaufkonus	Seil kürzen (siehe "Zubehör") oder anderen Montageort wählen
	Zu viel Materialansatz unten an der Sonde	Am Elektronikeinsatz Schalterstellung ändern oder Sonde säubern
	Sonde abgerissen => rote LED blinkt	FTC 262 austauschen; anderen Montageort wählen
	Elektronik in der Sonde oder im Gehäuse defekt => rote LED blinkt	FTC 262 austauschen
	Wechselstromausführung; Kontakte nach Kurzschluß verschweiß	FTC 262 austauschen; Sicherung in den Kontaktstromkreis
Schaltet falsch	MIN-/MAX- Sicherheitsschaltung vertauscht	Am Elektronikeinsatz Sicherheitsschaltung richtig einstellen
Fehlschaltung, sporadisch	Gleichstromausführung; Ausgang überlastet	Last, (Leitungs-) Kapazität verringern
	Sonde pendelt	Sonde abspannen
	Förderstrom trifft manchmal Sonde	Förderstrom umlenken oder anderen Montageort wählen
	Sonde berührt Materialansatz an der Behälterwand	Behälterwand freimachen oder anderen Montageort wählen
	Wasser im Gehäuse	Deckel und Kabeldurchführungen fest zuschrauben

en - Trouble-shooting

Fault	Reason	Remedy
Does not switch	No power (green LED does not light up)	Check power
	Dielectric ϵ_r of material too low	Change switch settings on electronic insert
	Poor ground connection	Check ground connection to silo or metal parts
	Probe touches vessel wall	Straighten rope
	Probe touches outlet cone	Shorten rope (see "Accessories") or select another mounting point
	Too much build-up on probe tip	Change switch settings on electronic insert or clean probe
	Probe pulled down => red LED flashes	Replace FTC 262; select another mounting point
	Electronics in probe or housing are defective => red LED flashes	Replace FTC 262
	AC version: Contacts melted together (after short-circuiting)	Replace FTC 262; connect a fuse into contactor circuit
Switches incorrectly	MIN-/MAX fail- safe mode set wrongly	Set correct mode at electronic insert
Sporadic faulty switching	DC version: Output overloaded	Reduce load, (cable) capacitance
	Probe oscillates	Tension probe
	Filling curtain sometimes touches probe	Redirect curtain or select another mounting point
	Probe touches material building on vessel wall	Clear vessel wall of building-up or select another mounting point
	Water in housing	Screw cover and cable gland tight

Défaut	Cause	Remède
Ne commute pas	Absence tension d'alimentation (diode verte éteinte)	Vérifier l'alimentation
	Coefficient diélectrique ϵ_r du produit en vrac trop faible	Modifier la position du commutateur sur l'électronique
	Mauvaise liaison à la masse	Vérifier la prise de terre du boîtier avec le réservoir ou avec les parties métalliques
	Sonde en contact avec la paroi du réservoir	Redresser le câble
	Sonde en contact avec le cône de sortie	Raccourcir le câble (voir "Accessoires") ou choisir un autre point de montage
	Dépôt trop important sur la partie inférieure de la sonde	Modifier la position du commutateur sur l'électronique ou nettoyer la sonde
	Sonde arrachée => Diode (LED) rouge clignote	Remplacer le FTC 262; choisir un autre point d'implantation
	Electronique dans la sonde ou le boîtier défectueuse => Diode (LED) rouge clignote	Remplacer le FTC 262
	Version courant alternatif: contacts soudés (après court-circuit)	Remplacer le FTC 262; insérer un fusible dans le circuit du contact
Commutation incorrecte	Sécurité MIN-/MAX verséet	Régler correctement la commutation de sécurité sur l'électronique
Commutation erronée sporadique	Exécution courant continu: sortie surchargée	Diminuer la charge, la capacité (de ligne)
	Balancement de la sonde	Amarrer la sonde
	Veine de produit entre parfois en contact avec la sonde	Dévier la veine ou choisir un autre point de montage
	Sonde en contact avec des dépôts sur la paroi du réservoir	Nettoyer la paroi du réservoir ou choisir un autre point de montage
	Eau dans le boîtier	Bien visser le couvercle et les entrées de câble

es - Identificación de fallos

Fallo	Causa	Solución
No se conecta	No hay alimentación (el LED verde no está iluminado)	Compruebe la alimentación
	Constante dieléctrica ϵ_r del material, demasiado baja	Cambie los ajustes de conexión de la tarjeta electrónica
	Conexión a tierra deficiente	Compruebe la conexión a tierra al silo o partes metálicas
	La sonda toca la pared del depósito	Enderece el cable de la sonda
	La sonda toca el cono de salida	Acorte la sonda (ver "Accesorios") o elija otro punto de montaje
	Demasiadas adherencias en el extremo de la sonda	Cambie los ajustes de interrupción de la electrónica o bien limpie la sonda
	Sonda caída => El LED rojo parpadea	Sustituya el FTC 262; elija otro punto de montaje
	Las electrónicas de la sonda o del cabezal son defectuosas => El LED rojo parpadea	Sustituya el FTC 262
	Versión AC: Los contactos se han fusionado (tras un cortocircuito)	Sustituya el FTC 262; Conecte un fusible en el circuito contactor
Contacto incorrecto	Ajuste incorrecto del modo de seguridad MIN-/MAX	Ajuste el modo correcto en la electrónica
Mal contacto esporádico	Versión DC: Salida con sobretensión	Reduzca la carga, (cable) capacidad
	La sonda oscila	Tense la sonda
	La cortina de llenado a veces toca la sonda	Redirija la cortina o elija otro punto de montaje
	La sonda toca las adherencias de la pared	Limpie la pared de adherencias o elija otro punto de montaje
	Agua en el cabezal	Apriete bien la cubierta y el prensaestopa

it – Individuazione e eliminazione delle anomalie

Difetti	Motivo	Rimedio
Non commuta	Manca alimentazione (LED verde spento)	Controllare l'alimentazione
	Costante dielettrica ϵ_r del materiale troppo bassa	Cambiare le impostazioni sull'inserito elettronico
	Manca connessione a terra	Controllare le connessioni al silo o alle parti metalliche
	La sonda tocca le pareti	Tirare la fune
	La sonda tocca il cono d'uscita	Accorciare la sonda (v. "Accessori") o cambiare il punto di montaggio
	Depositi sulla punta della sonda	Cambiare le impostazioni sull'inserito elettronico o pulire la sonda
	Sonda strappata => LED rosso lampeggia	Sostituire FTC 262; cambiare punto di montaggio
	Elettronica della sonda o nella custodia difettosa => LED rosso lampeggia	Sostituire FTC 262
	Versione AC: Contatti fusi (dopo un corto circuito)	Sostituire FTC 262; inserire un fusibile nel circuito dei contatti
Non commuta correttamente	Sicurezza di MIN/MAX impostata male	Correggere l'impostazione sull'inserito elettronico
Sporadicamente commuta male	Versione DC: Uscita sovraccarica	Ridurre il carico, capacità (del cavo)
	La fune oscilla	Tensionare la fune
	Il materiale tocca occasionalmente la sonda durante il riempimento	Devviare il materiale o cambiare punto di montaggio
	La sonda tocca il deposito sulle pareti	Togliere i depositi dalle pareti o cambiare punto di montaggio
	Acqua nella custodia	Avvitare a tenuta il coperchio e passacavi

nl - Fout zoeken

Fout	Oorzaak	Maatregel
Schakelt niet	Voeding ontbreekt (groene LED uit)	Voeding testen
	Diëlectrische constante ϵ_r van het product te gering	Instelling op elektronica wijzigen
	Slechte massaverbinding	Massa aansluiting tussen huis en silo testen
	Sensor raakt silowand	Kabel recht buigen
	Sensor raakt uitloopconus	Kabel inkorten ("zie Accessoires"), of ergens anders monteren
	Te veel aangroei	Instelling op elektronica wijzigen of sensor schoonmaken
	Sensor afgebroken => Rode LED knippert	FTC 262 uitwisselen; of andere montageplaats kiezen
	Elektronica in de sensor of in de kop defect => Rode LED knippert	FTC 262 uitwisselen
	Wisselspanningsuitvoering: contacten verkleefd (na een kortsluiting)	FTC 262 uitwisselen; zekering plaatsen in contactcircuit
Schakelt fout	MIN-/MAX-functie verwisseld	Op de elektronica veiligheidsschakeling correct instellen
Fautschakeling, sporadisch	Gelijkspanningsuitvoering: uitgang overbelast	Belasting, (kabel) capaciteit verminderen
	Sensor zwaait heen en weer	Sensor afspannen
	Vulstroom raakt soms de sensor	Vulstroom ombuigen of andere montageplaats kiezen
	Sensor raakt aangroei aan de wand	Silowand reinigen of andere montageplaats kiezen
	Water in het huis	Deksel en kabelwartels vastschroeven

Technische Information / Technical Information / Information technique /
Información técnica / Informazioni tecniche / Technische Informatie

Minicap FTC260, FTC262 → TI00287F

Sicherheitshinweise / Safety instructions, Conseils de sécurité / Instrucciones de
seguridad / Istruzioni di sicurezza / Veiligheidsinstructies

Minicap FTC262 → XA00092F

**de - Ergänzende
Dokumentation**

**en - Supplementary
Documentation**

**fr - Documentation
complémentaire**

**es - Documentación
adicional**

**it - Documentazione
supplementare**

**nl - Aanvullende
documentatie**



71438704

www.endress.com/worldwide
