

# Brief Operating Instructions

## Flowmeter

### Proline Prowirl R

Vortex flow sensor

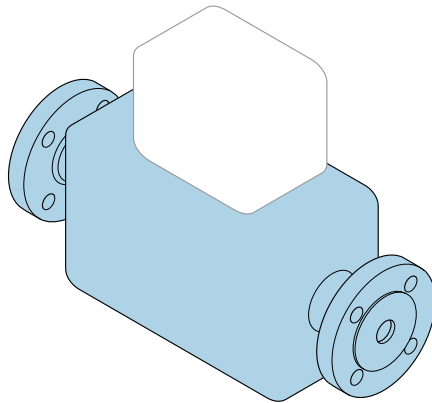

These instructions are Brief Operating Instructions; they are **not** a substitute for the Operating Instructions pertaining to the device.

#### **Brief Operating Instructions part 1 of 2: Sensor**

Contain information about the sensor.

Brief Operating Instructions part 2 of 2: Transmitter

→  3.



A0023555

## Brief Operating Instructions for the flowmeter

The device consists of a transmitter and a sensor.

The process of commissioning these two components is described in two separate manuals, that form the Brief Operating Instructions of the flowmeter:

- Brief Operating Instructions part 1: Sensor
- Brief Operating Instructions part 2: Transmitter

Please refer to both Brief Operating Instructions when commissioning the flowmeter as the contents complement one another:

### Brief Operating Instructions part 1: Sensor

The Sensor Brief Operating Instructions are aimed at specialists with responsibility for installing the measuring device.

- Incoming acceptance and product identification
- Storage and transport
- Installation

### Brief Operating Instructions part 2: Transmitter

The Transmitter Brief Operating Instructions are aimed at specialists with responsibility for commissioning, configuring and parameterizing the measuring device (until the first measured value).

- Product description
- Installation
- Electrical connection
- Operation options
- System integration
- Commissioning
- Diagnostic information

## Additional device documentation



These Brief Operating Instructions are the **Brief Operating Instructions part 1: Sensor**.

The "Brief Operating Instructions part 2: Transmitter" are available via:

- Internet: [www.endress.com/deviceviewer](http://www.endress.com/deviceviewer)
- Smart phone/tablet: *Endress+Hauser Operations App*

Detailed information about the device can be found in the Operating Instructions and the other documentation:

- Internet: [www.endress.com/deviceviewer](http://www.endress.com/deviceviewer)
- Smart phone/tablet: *Endress+Hauser Operations App*





# Table of contents

<b>1</b>	<b>Document information</b>	<b>5</b>
1.1	Symbols used	5
<b>2</b>	<b>Basic safety instructions</b>	<b>7</b>
2.1	Requirements for the personnel	7
2.2	Designated use	7
2.3	Workplace safety	8
2.4	Operational safety	8
2.5	Product safety	8
2.6	IT security	8
<b>3</b>	<b>Incoming acceptance and product identification</b>	<b>9</b>
3.1	Incoming acceptance	9
3.2	Product identification	10
<b>4</b>	<b>Storage and transport</b>	<b>10</b>
4.1	Storage conditions	10
4.2	Transporting the product	10
<b>5</b>	<b>Installation</b>	<b>12</b>
5.1	Installation conditions	12
5.2	Mounting the measuring device	20
5.3	Post-installation check	24
<b>6</b>	<b>Disposal</b>	<b>25</b>
6.1	Removing the measuring device	25
6.2	Disposing of the measuring device	25











# 1 Document information

## 1.1 Symbols used





### 1.1.1 Safety symbols

Symbol	Meaning
	<b>DANGER!</b> This symbol alerts you to a dangerous situation. Failure to avoid this situation will result in serious or fatal injury.
	<b>WARNING!</b> This symbol alerts you to a dangerous situation. Failure to avoid this situation can result in serious or fatal injury.
	<b>CAUTION!</b> This symbol alerts you to a dangerous situation. Failure to avoid this situation can result in minor or medium injury.
	<b>NOTE!</b> This symbol contains information on procedures and other facts which do not result in personal injury.

### 1.1.2 Symbols for certain types of information





Symbol	Meaning	Symbol	Meaning
	<b>Permitted</b> Procedures, processes or actions that are permitted.		<b>Preferred</b> Procedures, processes or actions that are preferred.
	<b>Forbidden</b> Procedures, processes or actions that are forbidden.		<b>Tip</b> Indicates additional information.
	Reference to documentation		Reference to page
	Reference to graphic		Series of steps
	Result of a step		Visual inspection

### 1.1.3 Electrical symbols





Symbol	Meaning	Symbol	Meaning
	Direct current		Alternating current
	Direct current and alternating current		<b>Ground connection</b> A grounded terminal which, as far as the operator is concerned, is grounded via a grounding system.

Symbol	Meaning
	<p><b>Protective Earth (PE)</b> A terminal which must be connected to ground prior to establishing any other connections.</p> <p>The ground terminals are situated inside and outside the device:</p> <ul style="list-style-type: none"> <li>■ Inner ground terminal: Connects the protective earth to the mains supply.</li> <li>■ Outer ground terminal: Connects the device to the plant grounding system.</li> </ul>





### 1.1.4 Communication symbols

Symbol	Meaning	Symbol	Meaning
	<p><b>Wireless Local Area Network (WLAN)</b> Communication via a wireless, local network.</p>		<p><b>LED</b> Light emitting diode is off.</p>
	<p><b>LED</b> Light emitting diode is on.</p>		<p><b>LED</b> Light emitting diode is flashing.</p>

### 1.1.5 Tool symbols

Symbol	Meaning	Symbol	Meaning
	Torx screwdriver		Flat blade screwdriver
	Cross-head screwdriver		Allen key
	Open-ended wrench		

### 1.1.6 Symbols in graphics

Symbol	Meaning	Symbol	Meaning
1, 2, 3,...	Item numbers		Series of steps
A, B, C, ...	Views	A-A, B-B, C-C, ...	Sections
	Hazardous area		Safe area (non-hazardous area)
	Flow direction		

## 2 Basic safety instructions

### 2.1 Requirements for the personnel

The personnel must fulfill the following requirements for its tasks:

- ▶ Trained, qualified specialists must have a relevant qualification for this specific function and task.
- ▶ Are authorized by the plant owner/operator.
- ▶ Are familiar with federal/national regulations.
- ▶ Before starting work, read and understand the instructions in the manual and supplementary documentation as well as the certificates (depending on the application).
- ▶ Follow instructions and comply with basic conditions.

### 2.2 Designated use

#### Application and media

Depending on the version ordered, the measuring device can also measure potentially explosive, flammable, poisonous and oxidizing media.

Measuring devices for use in hazardous areas, in hygienic applications or where there is an increased risk due to process pressure, are labeled accordingly on the nameplate.

To ensure that the measuring device remains in proper condition for the operation time:

- ▶ Keep within the specified pressure and temperature range.
- ▶ Only use the measuring device in full compliance with the data on the nameplate and the general conditions listed in the Operating Instructions and supplementary documentation.
- ▶ Based on the nameplate, check whether the ordered device is permitted for the intended use in the hazardous area (e.g. explosion protection, pressure vessel safety).
- ▶ Use the measuring device only for media to which the process-wetted materials are sufficiently resistant.
- ▶ If the measuring device is not operated at atmospheric temperature, compliance with the relevant basic conditions specified in the associated device documentation is absolutely essential: "Documentation" section.
- ▶ Protect the measuring device permanently against corrosion from environmental influences.

#### Incorrect use

Non-designated use can compromise safety. The manufacturer is not liable for damage caused by improper or non-designated use.

#### **WARNING**

#### **Danger of breakage due to corrosive or abrasive fluids!**

- ▶ Verify the compatibility of the process fluid with the sensor material.
- ▶ Ensure the resistance of all fluid-wetted materials in the process.
- ▶ Keep within the specified pressure and temperature range.

**NOTICE****Verification for borderline cases:**

- ▶ For special fluids and fluids for cleaning, Endress+Hauser is glad to provide assistance in verifying the corrosion resistance of fluid-wetted materials, but does not accept any warranty or liability as minute changes in the temperature, concentration or level of contamination in the process can alter the corrosion resistance properties.

**Residual risks****⚠ WARNING**

**The electronics and the medium may cause the surfaces to heat up. This presents a burn hazard!**

- ▶ For elevated fluid temperatures, ensure protection against contact to prevent burns.

## 2.3 Workplace safety

For work on and with the device:

- ▶ Wear the required personal protective equipment according to federal/national regulations.

For welding work on the piping:

- ▶ Do not ground the welding unit via the measuring device.

If working on and with the device with wet hands:

- ▶ Due to the increased risk of electric shock, gloves must be worn.

## 2.4 Operational safety

Risk of injury!

- ▶ Operate the device in proper technical condition and fail-safe condition only.
- ▶ The operator is responsible for interference-free operation of the device.

## 2.5 Product safety

This measuring device is designed in accordance with good engineering practice to meet state-of-the-art safety requirements, has been tested, and left the factory in a condition in which it is safe to operate.

It meets general safety standards and legal requirements. It also complies with the EU directives listed in the device-specific EU Declaration of Conformity. Endress+Hauser confirms this by affixing the CE mark to the device.

## 2.6 IT security

We only provide a warranty if the device is installed and used as described in the Operating Instructions. The device is equipped with security mechanisms to protect it against any inadvertent changes to the device settings.

IT security measures in line with operators' security standards and designed to provide additional protection for the device and device data transfer must be implemented by the operators themselves.



### 3 Incoming acceptance and product identification

#### 3.1 Incoming acceptance



A0028673

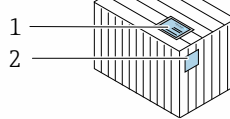
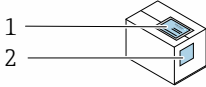

Are the order codes on the delivery note (1) and the product sticker (2) identical?

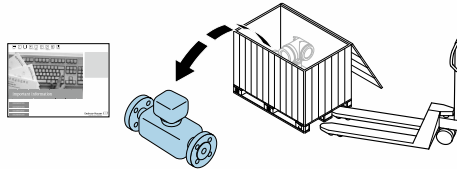

A0028673

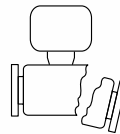
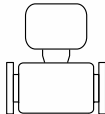

Are the goods undamaged?



A0028673

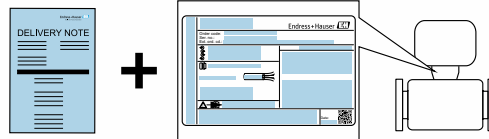

Do the nameplate data match the ordering information on the delivery note?



A0028673



Is the CD-ROM with the Technical Documentation (depends on device version) and documents present?



- If one of the conditions is not satisfied, contact your Endress+Hauser Sales Center.
- Depending on the device version, the CD-ROM might not be part of the delivery! The Technical Documentation is available via the Internet or via the *Endress+Hauser Operations App*.

## 3.2 Product identification

The following options are available for identification of the measuring device:

- Nameplate specifications
- Order code with breakdown of the device features on the delivery note
- Enter serial numbers from nameplates in *W@M Device Viewer* ([www.endress.com/deviceviewer](http://www.endress.com/deviceviewer)): All information about the measuring device is displayed.
- Enter the serial number from the nameplates into the *Endress+Hauser Operations App* or scan the 2-D matrix code (QR code) on the nameplate with the *Endress+Hauser Operations App*: all the information for the measuring device is displayed.

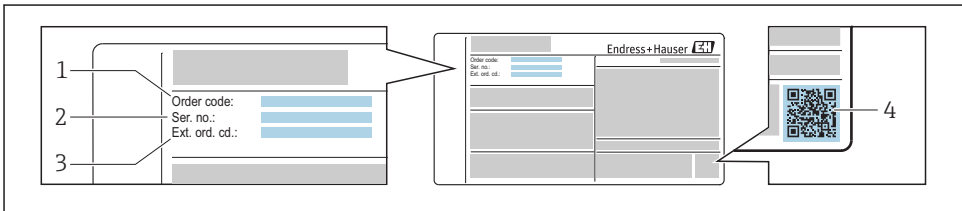

A0030196

### 1 Example of a nameplate

- 1 Order code
- 2 Serial number (Ser. no.)
- 3 Extended order code (Ext. ord. cd.)
- 4 2-D matrix code (QR code)

 For detailed information on the breakdown of the specifications on the nameplate, see the Operating Instructions for the device .

## 4 Storage and transport

### 4.1 Storage conditions

Observe the following notes for storage:

- ▶ Store in the original packaging to ensure protection from shock.
- ▶ Do not remove protective covers or protective caps installed on process connections. They prevent mechanical damage to the sealing surfaces and contamination in the measuring tube.
- ▶ Protect from direct sunlight to avoid unacceptably high surface temperatures.
- ▶ Store in a dry and dust-free place.
- ▶ Do not store outdoors.

### 4.2 Transporting the product

Transport the measuring device to the measuring point in the original packaging.

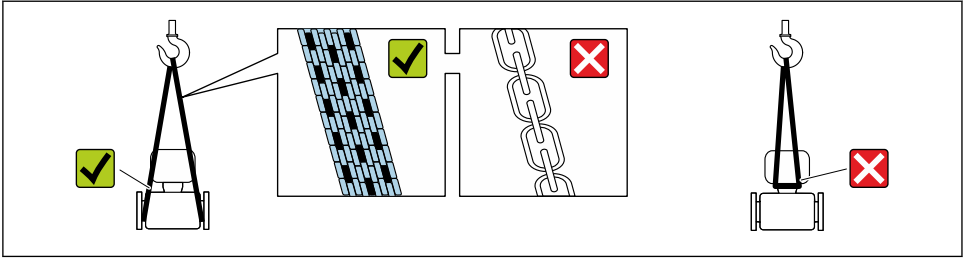

A0029252

**i** Do not remove protective covers or caps installed on process connections. They prevent mechanical damage to the sealing surfaces and contamination in the measuring tube.

#### 4.2.1 Measuring devices without lifting lugs

##### **⚠ WARNING**

**Center of gravity of the measuring device is higher than the suspension points of the webbing slings.**

Risk of injury if the measuring device slips.

- ▶ Secure the measuring device against slipping or turning.
- ▶ Observe the weight specified on the packaging (stick-on label).

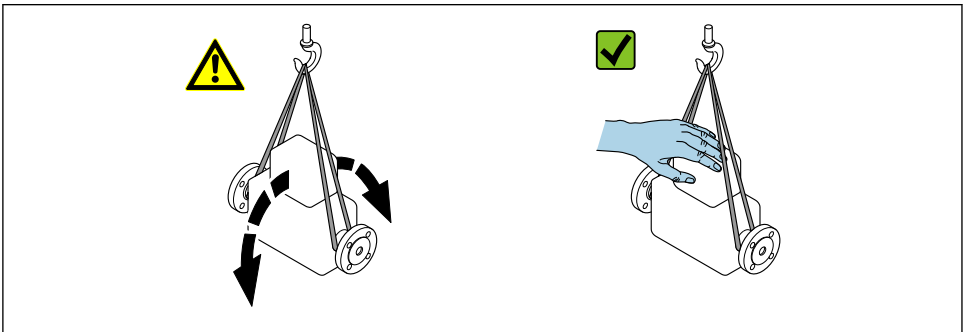

A0029214

#### 4.2.2 Measuring devices with lifting lugs

##### **⚠ CAUTION**

**Special transportation instructions for devices with lifting lugs**

- ▶ Only use the lifting lugs fitted on the device or flanges to transport the device.
- ▶ The device must always be secured at two lifting lugs at least.

#### 4.2.3 Transporting with a fork lift

If transporting in wood crates, the floor structure enables the crates to be lifted lengthwise or at both sides using a forklift.

# 5 Installation

## 5.1 Installation conditions

### 5.1.1 Mounting position

#### Mounting location

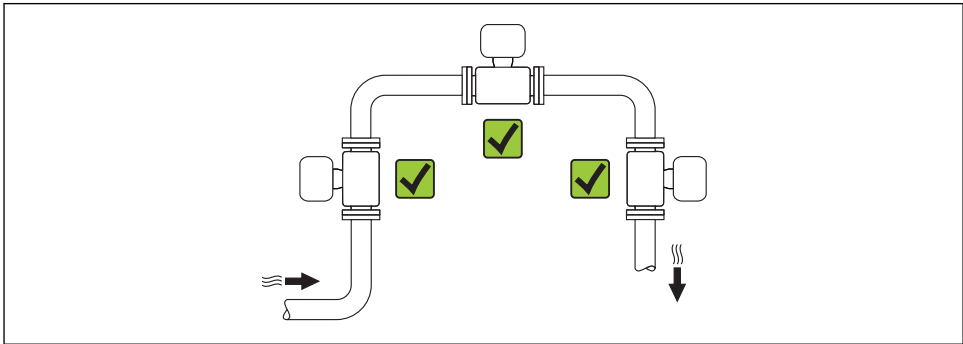

A0015543

#### Orientation

The direction of the arrow on the sensor nameplate helps you to install the sensor according to the flow direction.

Vortex meters require a fully developed flow profile as a prerequisite for correct volume flow measurement. Therefore, please note the following:

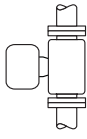
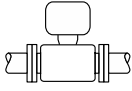
Orientation			Compact version	Remote version
<b>A</b>	Vertical orientation	 A0015545	✓✓ <sup>1)</sup>	✓✓
<b>B</b>	Horizontal orientation, transmitter head up	 A0015589	✓✓ <sup>2) 3)</sup>	✓✓

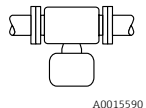
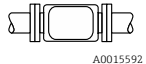
Orientation		Compact version	Remote version
C	Horizontal orientation, transmitter head down	 A0015590	✓✓ <sup>4)</sup>
D	Horizontal orientation, transmitter head at side	 A0015592	✓✓

- 1) In the case of liquids, there should be upward flow in vertical pipes to avoid partial pipe filling (Fig. A). Disruption in flow measurement! In the case of vertical orientation and downward flowing liquid, the pipe always needs to be completely filled to ensure correct liquid flow measurement.
- 2) Danger of electronics overheating! If the fluid temperature is  $\geq 200\text{ }^\circ\text{C}$  ( $392\text{ }^\circ\text{F}$ ), orientation B is not permitted for the wafer version (Prowirl D) with nominal diameters of DN 100 (4") and DN 150 (6").
- 3) In the case of hot media (e.g. steam or fluid temperature (TM)  $\geq 200\text{ }^\circ\text{C}$  ( $392\text{ }^\circ\text{F}$ ): orientation C or D
- 4) In the case of very cold media (e.g. liquid nitrogen): orientation B or D



The "mass" sensor version (integrated pressure/temperature measurement) is available only for measuring devices in the HART communication mode.

*Pressure measuring cell*

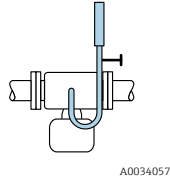
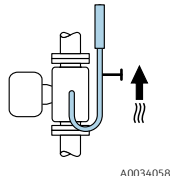
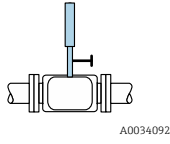
Steam pressure measurement		Option DA
E	<ul style="list-style-type: none"> <li>▪ With the transmitter installed at the bottom or at the side</li> <li>▪ Protection against rising heat</li> </ul>	 A0034057
F	<ul style="list-style-type: none"> <li>▪ Reduction in temperature to almost ambient temperature due to siphon<sup>1)</sup></li> </ul>	 A0034058
Gas pressure measurement		Option DB
G	<ul style="list-style-type: none"> <li>▪ Pressure measuring cell with shut off device above tapping point</li> <li>▪ Discharge of any condensate into the process</li> </ul>	 A0034092

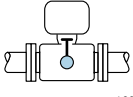
Liquid pressure measurement		Option DB	
H	Device with shut off device at the same level as tapping point	 A0034091	✓✓

- 1) Note max. permitted ambient temperature of transmitter.

### Minimum spacing and cable length

Order code for "Sensor version", option "mass" DA, DB

 The "mass" sensor version (integrated pressure/temperature measurement) is available only for measuring devices in the HART communication mode.

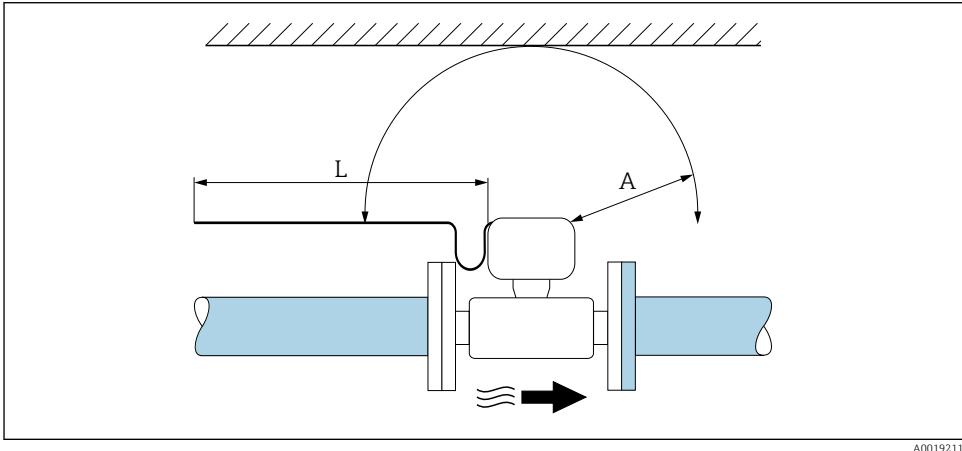

A0019211

A Minimum spacing in all directions

L Required cable length

The following dimensions must be observed to guarantee problem-free access to the device for service purposes:

- A = 100 mm (3.94 in)
- L = L + 150 mm (5.91 in)

### Inlet and outlet runs

To attain the specified level of accuracy of the measuring device, the inlet and outlet runs mentioned below must be maintained at the very minimum.

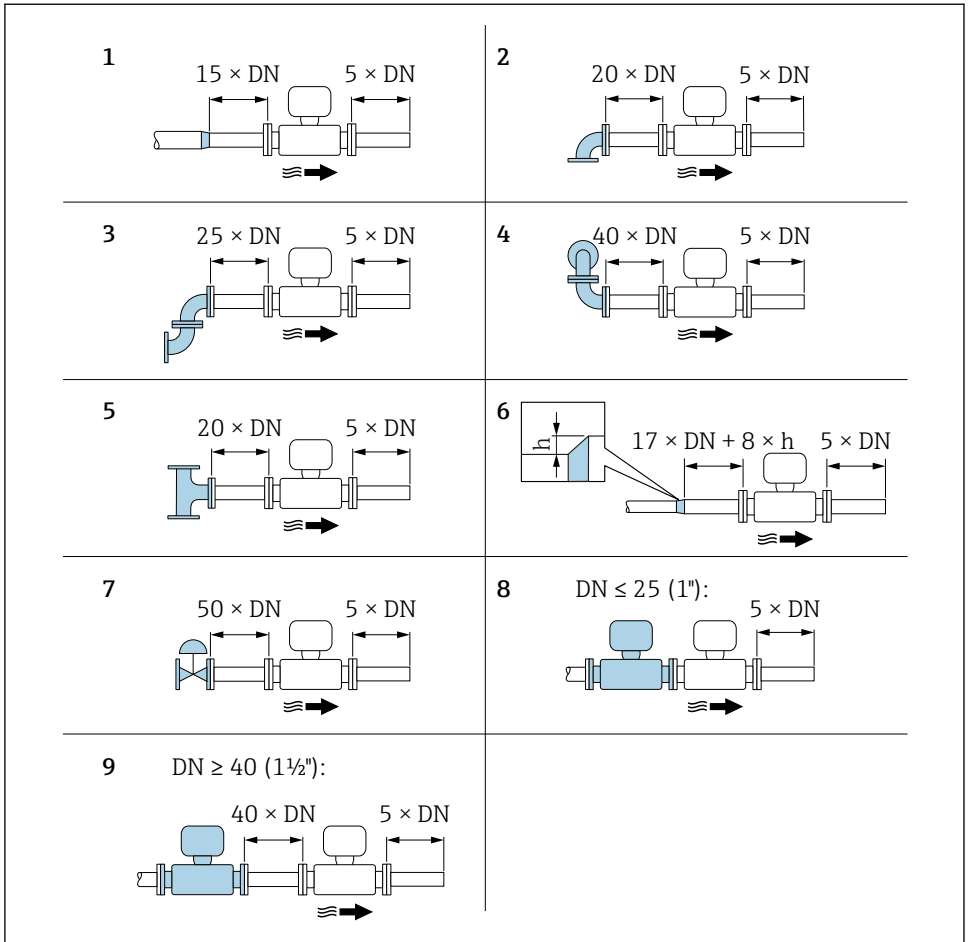

A0019189

**2** Minimum inlet and outlet runs with various flow obstructions

*h* Difference in expansion

1 Reduction by one nominal diameter size

2 Single elbow (90° elbow)



3 Double elbow (2 × 90° elbows, opposite)

4 Double elbow 3D (2 × 90° elbows, opposite, not on one plane)

5 T-piece

6 Expansion

- 7 Control valve
- 8 Two measuring devices in a row where  $DN \leq 25$  (1"): directly flange on flange
- 9 Two measuring devices in a row where  $DN \geq 40$  (1½"): for spacing, see graphic

-  If there are several flow disturbances present, the longest specified inlet run must be maintained.
- If the required inlet runs cannot be observed, it is possible to install a specially designed flow conditioner →  16.

 For detailed information about inlet run correction and wet steam detection, see the Special Documentation for the device

 For the dimensions and installation lengths of the device, see the "Technical Information" document, "Mechanical construction" section.

### Flow conditioner

If the inlet runs cannot be observed, the use of a flow conditioner is recommended.

The flow conditioner is fitted between two pipe flanges and centered by the mounting bolts. Generally this reduces the inlet run needed to  $10 \times DN$  with full accuracy.

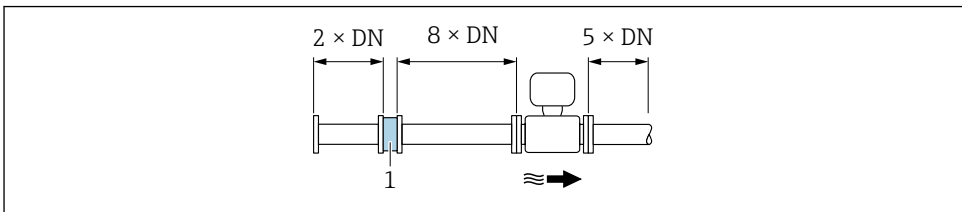

A0019208

### 1 Flow conditioner

The pressure loss for flow conditioners is calculated as follows:  $\Delta p$  [mbar] =  $0.0085 \cdot \rho$  [ $\text{kg}/\text{m}^3$ ]  $\cdot v^2$  [ $\text{m}/\text{s}$ ]

Example for steam

$$p = 10 \text{ bar abs.}$$

$$t = 240 \text{ }^\circ\text{C} \rightarrow \rho = 4.39 \text{ kg}/\text{m}^3$$

$$v = 40 \text{ m}/\text{s}$$

$$\Delta p = 0.0085 \cdot 4.394.39 \cdot 40^2 = 59.7 \text{ mbar}$$

Example for  $\text{H}_2\text{O}$  condensate ( $80 \text{ }^\circ\text{C}$ )

$$\rho = 965 \text{ kg}/\text{m}^3$$

$$v = 2.5 \text{ m}/\text{s}$$

$$\Delta p = 0.0085 \cdot 965 \cdot 2.5^2 = 51.3 \text{ mbar}$$



$\rho$  : density of the process medium  
 v: average flow velocity  
 abs. = absolute

 For the dimensions of the flow conditioner, see the "Technical Information" document, "Mechanical construction" section

*Outlet runs when installing external devices*

If installing an external device, observe the specified distance.

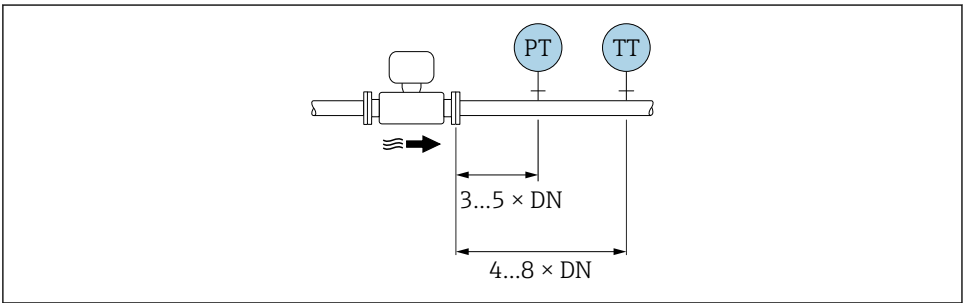

A0019205

PT Pressure  
 TT Temperature device

**5.1.2 Requirements from environment and process**

**Ambient temperature range**

*Compact version*

<b>Measuring device</b>	Non-hazardous area:	-40 to +80 °C (-40 to +176 °F) <sup>1)</sup>
	Ex i, Ex nA, Ex ec:	-40 to +70 °C (-40 to +158 °F) <sup>1)</sup>
	Ex d, XP:	-40 to +60 °C (-40 to +140 °F) <sup>1)</sup>
	Ex d, Ex ia:	-40 to +60 °C (-40 to +140 °F) <sup>1)</sup>
<b>Local display</b>		-40 to +70 °C (-40 to +158 °F) <sup>2) 1)</sup>

- 1) Additionally available as order code for "Test, certificate", option JN "Transmitter ambient temperature -50 °C (-58 °F)".
- 2) At temperatures < -20 °C (-4 °F), depending on the physical characteristics involved, it may no longer be possible to read the liquid crystal display.

*Remote version*

<b>Transmitter</b>	Non-hazardous area:	-40 to +80 °C (-40 to +176 °F) <sup>1)</sup>
	Ex i, Ex nA, Ex ec:	-40 to +80 °C (-40 to +176 °F) <sup>1)</sup>

	Ex d:	-40 to +60 °C (-40 to +140 °F) <sup>1)</sup>
	Ex d, Ex ia:	-40 to +60 °C (-40 to +140 °F) <sup>1)</sup>
<b>Sensor</b>	Non-hazardous area:	-40 to +85 °C (-40 to +185 °F) <sup>1)</sup>
	Ex i, Ex nA, Ex ec:	-40 to +85 °C (-40 to +185 °F) <sup>1)</sup>
	Ex d:	-40 to +85 °C (-40 to +185 °F) <sup>1)</sup>
	Ex d, Ex ia:	-40 to +85 °C (-40 to +185 °F) <sup>1)</sup>
<b>Local display</b>		-40 to +70 °C (-40 to +158 °F) <sup>2) 1)</sup>

- 1) Additionally available as order code for "Test, certificate", option JN "Transmitter ambient temperature -50 °C (-58 °F)".
- 2) At temperatures < -20 °C (-4 °F), depending on the physical characteristics involved, it may no longer be possible to read the liquid crystal display.

► If operating outdoors:

Avoid direct sunlight, particularly in warm climatic regions.

### Thermal insulation

For optimum temperature measurement and mass calculation, heat transfer at the sensor must be avoided for some fluids. This can be ensured by installing thermal insulation. A wide range of materials can be used for the required insulation.

This applies for:

- Compact version
- Remote sensor version

The maximum insulation height permitted is illustrated in the diagram:

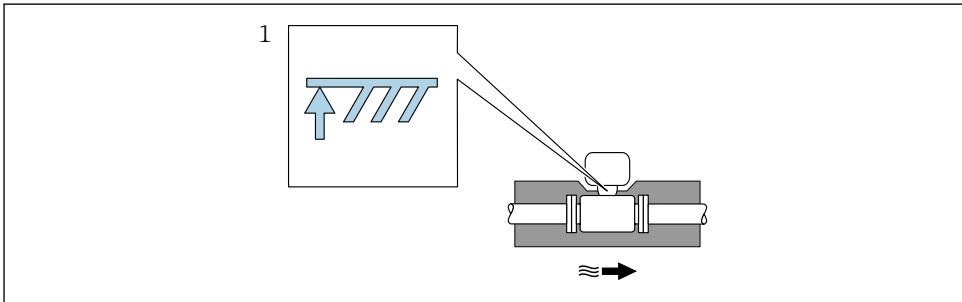

A0019212

1 *Maximum insulation height*

- When insulating, ensure that a sufficiently large area of the housing support remains exposed.

The uncovered part serves as a radiator and protects the electronics from overheating and excessive cooling.

**NOTICE****Electronics overheating on account of thermal insulation!**

- ▶ Observe the maximum permitted insulation height of the transmitter neck so that the transmitter head and/or the connection housing of the remote version is completely free.
- ▶ Observe information on the permissible temperature ranges.
- ▶ Note that a certain orientation might be required, depending on the fluid temperature.



For detailed information about the fluid temperature, orientations and permitted temperature ranges, refer to the Operating Instructions for the device

**5.1.3 Special mounting instructions****Installation for delta heat measurements**

- Order code for "Sensor version", option CA "mass; 316L; 316L (integrated temperature measurement), -200 to +400 °C (-328 to +750 °F)"
- Order code for "Sensor version", option CB "mass; Alloy C22; 316L (integrated temperature measurement), -200 to +400 °C (-328 to +750 °F)"
- Order code for "Sensor version", option DA "mass steam; 316L; 316L (integrated pressure/temperature measurement), -200 to +400 °C (-328 to +750 °F)"
- Order code for "Sensor version", option DB "mass gas/liquid; 316L; 316L (integrated pressure/temperature measurement), -40 to +100 °C (-40 to +212 °F)"

The second temperature measurement is taken using a separate temperature sensor. The measuring device reads in this value via a communication interface.

- In the case of saturated steam delta heat measurements, the measuring device must be installed on the steam side.
- In the case of water delta heat measurements, the device can be installed on the cold or warm side.

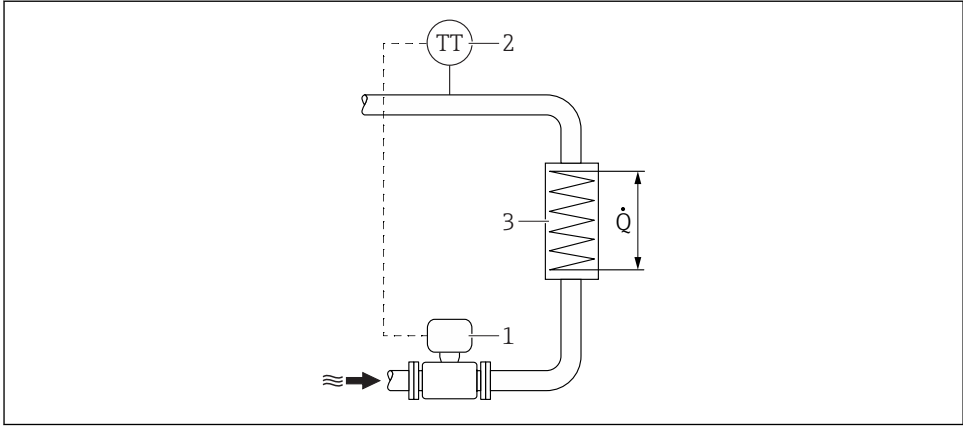

A0019209

### 3 Layout for delta heat measurement of saturated steam and water

- 1 Measuring device
- 2 Temperature sensor
- 3 Heat exchanger
- Q Heat flow

## Protective cover

Observe the following minimum head clearance: 222 mm (8.74 in)

## 5.2 Mounting the measuring device

### 5.2.1 Required tools

#### For transmitter

- For turning the transmitter housing: Open-ended wrench 8 mm
- For opening the securing clamps: Allen key 3 mm
- For turning the transmitter housing: Open-ended wrench 8 mm
- For opening the securing clamps: Allen key 3 mm

#### For sensor

For flanges and other process connections: Corresponding mounting tools

### 5.2.2 Preparing the measuring device

1. Remove all remaining transport packaging.
2. Remove any protective covers or protective caps present from the sensor.
3. Remove stick-on label on the electronics compartment cover.

### 5.2.3 Mounting the sensor

#### **⚠ WARNING**

#### **Danger due to improper process sealing!**

- ▶ Ensure that the inside diameters of the gaskets are greater than or equal to that of the process connections and piping.
  - ▶ Ensure that the gaskets are clean and undamaged.
  - ▶ Install the gaskets correctly.
1. Ensure that the direction of the arrow on the sensor matches the flow direction of the medium.
  2. To ensure compliance with device specifications, install the measuring device between the pipe flanges in a way that it is centered in the measurement section.
  3. Install the measuring device or turn the transmitter housing so that the cable entries do not point upwards.

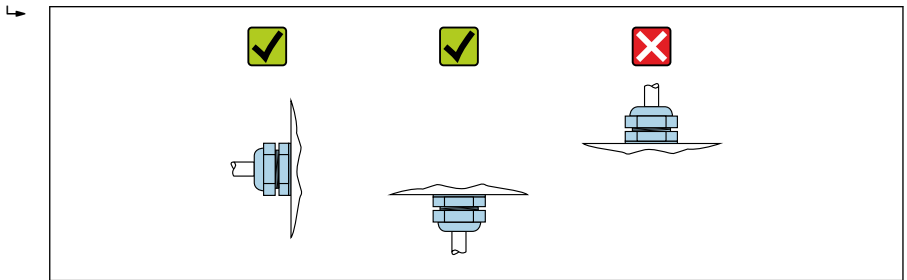

A0029263

### 5.2.4 Mounting the pressure measuring unit

#### **Preparation**

1. Prior to mounting the pressure measuring unit, install the measuring device in the pipe.
2. When mounting the pressure measuring unit, use only the seal provided. The use of a different sealing material is not permitted.

## Removing the blind flange

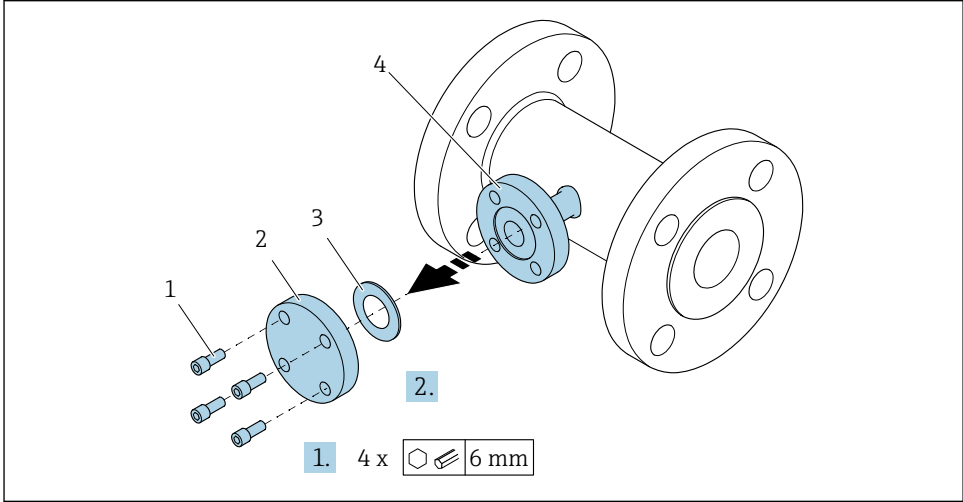

A0034355

- 1 *Mounting screws*
- 2 *blind flange*
- 3 *Seal*
- 4 *Flange connection on sensor side*

### NOTICE

**When replacing the seal following commissioning, fluid may escape when the flange connection is opened!**

- ▶ Ensure that the measuring device is not under pressure.
- ▶ Ensure that there is no fluid in the measuring device.

1. Release the mounting screws on the blind flange.
  - ↳ The screws are needed again to mount the pressure measuring unit.
2. Remove the internal seal.

## Mounting the pressure measuring unit

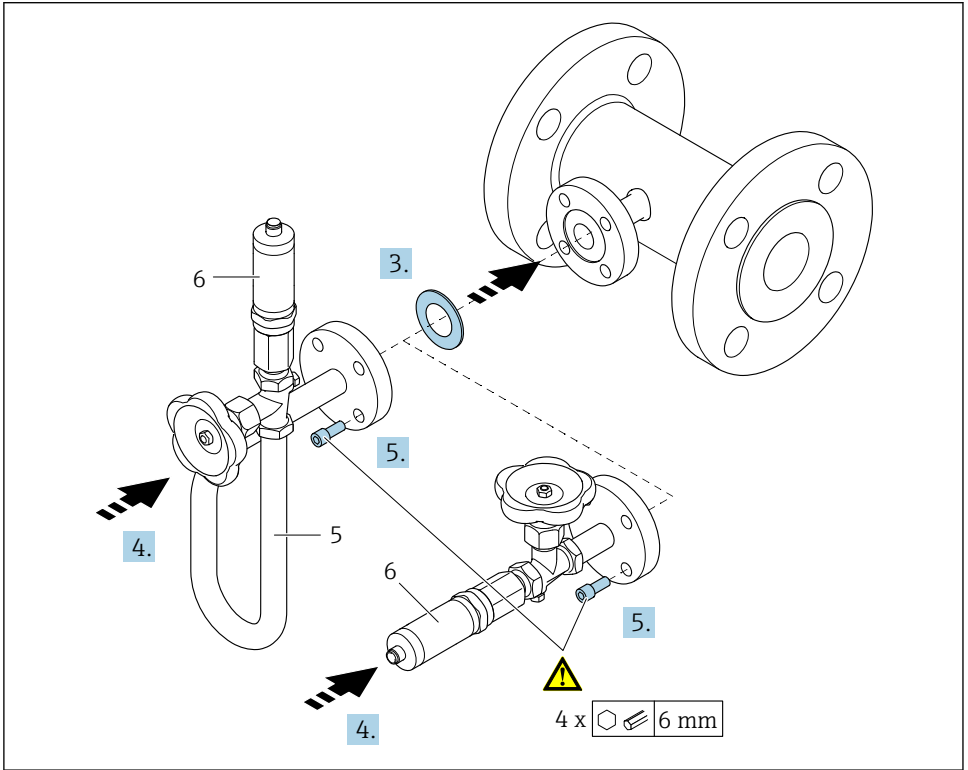

A0035442

- 5 Siphon  
6 Pressure measuring cell

### 3. **NOTICE**

#### Damage to seal!

The seal is made of expanded graphite. It can therefore be used only once. If a coupling is released, a new seal must be installed.

- ▶ Use the additional seals provided. If necessary, these can be ordered as separate spare parts at a later stage.

Insert the enclosed seal into the groove of the flange connection on the sensor side.

4. Align the flange connection on the pressure measuring unit and tighten the screws by hand.
5. Tighten the screws with a torque wrench in three steps.
- ↳ 1. 10 Nm in criss-cross sequence
  - 2. 15 Nm in criss-cross sequence
  - 3. 15 Nm in circular sequence

### Connecting the pressure measuring unit

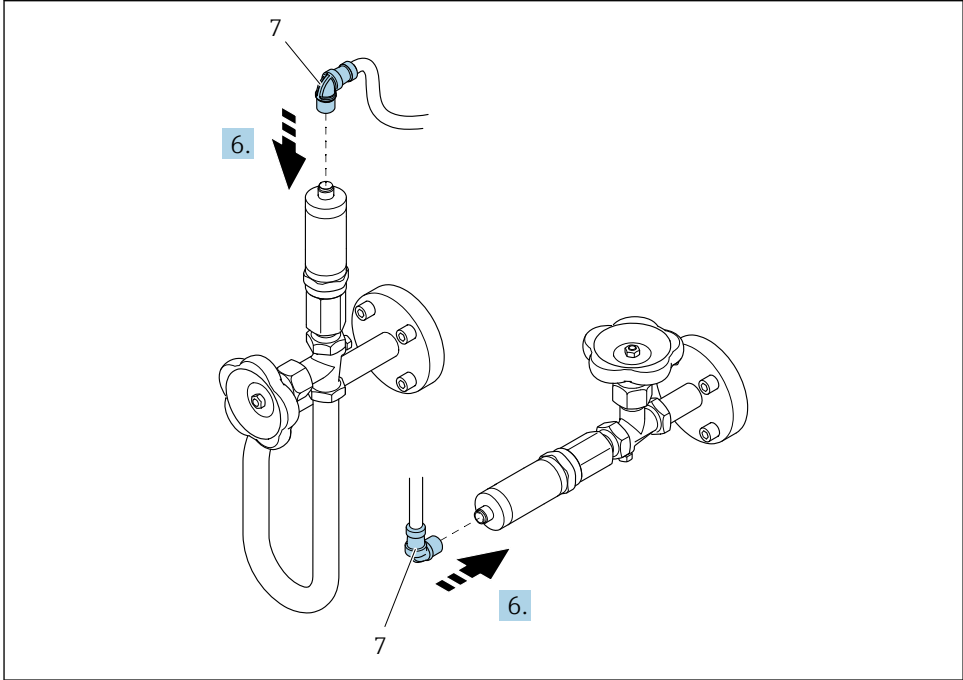

A0035443



7 Device plug

- 6. Insert the plug for electrical connection of the pressure measuring cell and screw into place.

### 5.3 Post-installation check

Is the device undamaged (visual inspection)?	<input type="checkbox"/>
Does the measuring device conform to the measuring point specifications? For example:	
<ul style="list-style-type: none"> <li>▪ Process temperature</li> <li>▪ Process pressure (refer to the section on "Pressure-temperature ratings" in the "Technical Information" document)</li> <li>▪ Ambient temperature → 17</li> <li>▪ Measuring range</li> </ul>	<input type="checkbox"/>
Has the correct orientation for the sensor been selected → 12?	
<ul style="list-style-type: none"> <li>▪ According to sensor type</li> <li>▪ According to medium temperature</li> <li>▪ According to medium properties (outgassing, with entrained solids)</li> </ul>	<input type="checkbox"/>
Does the arrow on the sensor nameplate match the direction of flow of the fluid through the piping → 12?	<input type="checkbox"/>
Are the measuring point identification and labeling correct (visual inspection)?	<input type="checkbox"/>



Is the device adequately protected against precipitation and direct sunlight?	<input type="checkbox"/>
Are the securing screw and securing clamp tightened securely?	<input type="checkbox"/>
Has the maximum permitted insulation height been observed?	<input type="checkbox"/>
<ul style="list-style-type: none"> <li>▪ Has the pressure range been observed?</li> <li>▪ Was the correct orientation selected →  13?</li> <li>▪ Is the pressure unit mounted correctly →  21?</li> <li>▪ Have the pressure gauge valve and the siphon with pressure sensor been mounted using the prescribed seal and the specified torque →  21?</li> </ul>	<input type="checkbox"/>

## 6 Disposal

### 6.1 Removing the measuring device

1. Switch off the device.

#### WARNING

#### **Danger to persons from process conditions.**

- ▶ Beware of hazardous process conditions such as pressure in the measuring device, high temperatures or aggressive fluids.

2. Carry out the mounting and connection steps from the "Mounting the measuring device" and "Connecting the measuring device" sections in reverse order. Observe the safety instructions.

### 6.2 Disposing of the measuring device

#### WARNING

#### **Danger to personnel and environment from fluids that are hazardous to health.**

- ▶ Ensure that the measuring device and all cavities are free of fluid residues that are hazardous to health or the environment, e.g. substances that have permeated into crevices or diffused through plastic.

Observe the following notes during disposal:

- ▶ Observe valid federal/national regulations.
- ▶ Ensure proper separation and reuse of the device components.





[www.addresses.endress.com](http://www.addresses.endress.com)

---