

Special Documentation

Proline Promass I 300

HART

Viscosity Measurement application package



Table of contents

1	About this document	4
1.1	Document function	4
1.2	Content and scope	4
1.3	Symbols used	4
1.4	Documentation	5
1.5	Registered trademarks	5
2	Product features and availability	6
2.1	Product features	6
2.2	Availability	6
3	System integration	7
4	Commissioning	8
4.1	Advanced settings	8
4.2	Simulation	10
5	Operation	11
5.1	Reading measured values	11
6	Technical data	12
6.1	Input	12
6.2	Performance characteristics	13
7	Viscosity fundamentals	15
7.1	Definitions of viscosity (general)	15
7.2	Differentiating viscous behavior	17
7.3	Principle of viscosity measurement with Promass I	20
7.4	Temperature correction of the viscosity value	21
7.5	Formula models for temperature correction ..	22
8	Comparison tables for viscosities ...	23

1 About this document

1.1 Document function

This manual is Special Documentation; it does not replace the Operating Instructions pertaining to the device. It serves as a reference for using the Viscosity Measurement function integrated in the measuring device.

1.2 Content and scope





This documentation contains a description of the additional parameters and technical data that are provided with the **Viscosity** application package.

It provides detailed information on:









- Application-specific parameters
- Advanced technical specifications



1.3 Symbols used

1.3.1 Safety symbols

Symbol	Meaning
	DANGER! This symbol alerts you to a dangerous situation. Failure to avoid this situation will result in serious or fatal injury.
	WARNING! This symbol alerts you to a dangerous situation. Failure to avoid this situation can result in serious or fatal injury.
	CAUTION! This symbol alerts you to a dangerous situation. Failure to avoid this situation can result in minor or medium injury.
	NOTE! This symbol contains information on procedures and other facts which do not result in personal injury.

1.3.2 Symbols for certain types of information

Symbol	Meaning
	Tip Indicates additional information.
	Reference to documentation
	Reference to page
	Reference to graphic
	Notice or individual step to be observed
	Series of steps
	Result of a step
	Operation via local display

Symbol	Meaning
	Operation via operating tool
	Write-protected parameter

1.3.3 Symbols in graphics

Symbol	Meaning
1, 2, 3 ...	Item numbers
A, B, C, ...	Views
A-A, B-B, C-C, ...	Sections

1.4 Documentation

 For an overview of the scope of the associated Technical Documentation, refer to the following:

- The *W@M Device Viewer* : Enter the serial number from the nameplate (www.endress.com/deviceviewer)
- The *Endress+Hauser Operations App*: Enter the serial number from the nameplate or scan the 2-D matrix code (QR code) on the nameplate.

This documentation is not a substitute for the Operating Instructions supplied with the device.

The Operating Instructions and additional documentation contain all detailed information on the device:

- Internet: www.endress.com/deviceviewer
- Smart phone/tablet: *Endress+Hauser Operations App*

This documentation is an integral part of the following Operating Instructions:

Measuring device	Documentation code
Promass I 300	BA01487D

-  This Special Documentation is available:
- On the CD-ROM supplied with the device (depending on the device version ordered)
 - In the Download Area of the Endress+Hauser Internet site: www.endress.com → Download

1.5 Registered trademarks

HART®

Registered trademark of the FieldComm Group, Austin, Texas, USA

2 Product features and availability

2.1 Product features

Additional parameters, options and measured variables are available in the device with the "Viscosity" application package.

The following viscosity measurements are performed on liquids:

- Dynamic viscosity
- Kinematic viscosity
- Temperature-compensated viscosity (kinematic and dynamic) in relation to the reference temperature

Viscosity measurement can be used for Newtonian and non-Newtonian applications and supplies accurate measured data irrespective of the flow, even under difficult conditions.

2.2 Availability

The **Viscosity** application package can be ordered directly with the device.

It can be enabled subsequently by entering an activation code. Detailed information on the order code in question is available from your local Endress+Hauser sales center or on the product page of the Endress+Hauser website: www.endress.com.

It is possible to check the availability of the **Viscosity** application package with the **EG** option as follows:

- Order code with breakdown of the device features on the delivery note
- In the W@M Device Viewer (www.endress.com/deviceviewer)
Enter the serial number from the nameplate and in the device information check whether the option **EG** "Viscosity" appears under the order code for "Application packages".
- In the operating menu:
The software options currently enabled are displayed in the **Software option overview** parameter.
Expert → System → Administration

2.2.1 Order code

If ordering directly with the device or subsequently as a retrofit kit:
Order code for "Application packages", option **EG** "Viscosity"

2.2.2 Activation

A retrofit kit is supplied if the application package is ordered subsequently.

This kit includes a tag plate with device data and an activation code.



For details, see Installation Instructions EA001164D

2.2.3 Access

The application package is compatible with all the system integration options. Interfaces with digital communication are required to access the data saved in the device. The speed of data transmission depends on the type of communication interface used.

3 System integration

Extended choice of measured variables if the **Viscosity** application package is used:

- Dynamic viscosity
- Kinematic viscosity
- Temp. compensated dynamic viscosity
- Temp. compensated kinematic viscosity

Detailed information on system integration:



Operating Instructions for the device →  5

4 Commissioning

4.1 Advanced settings

Navigation

"Setup" menu → Advanced setup → Viscosity

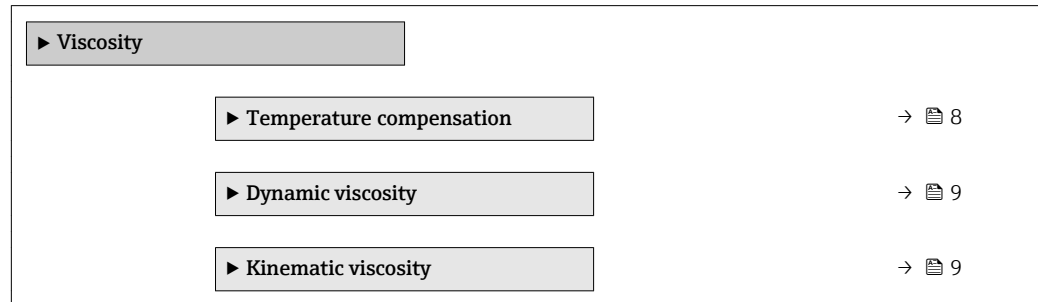

4.1.1 Temperature compensation

Navigation

"Setup" menu → Advanced setup → Viscosity → Temperature compensation

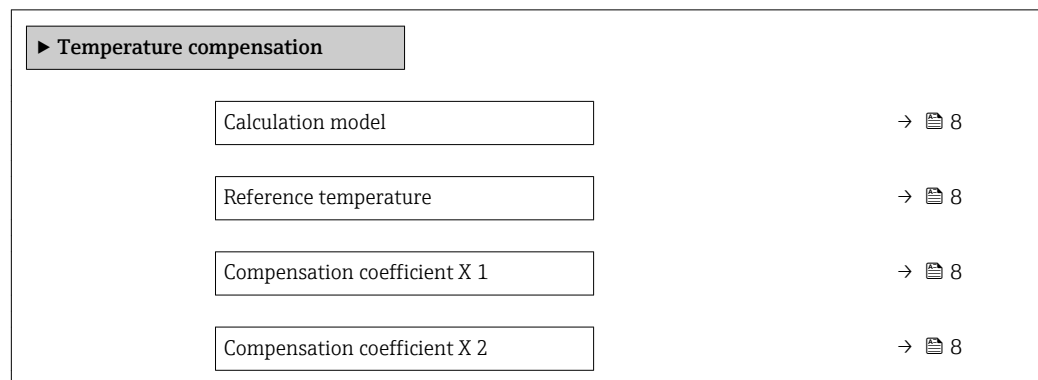

Parameter overview with brief description

Parameter	Description	Selection / User entry	Factory setting
Calculation model	Select a formula for the temperature compensation of viscosity.	<ul style="list-style-type: none"> ■ Power law ■ Exponential ■ Polynomial 	Polynomial
Reference temperature	Enter reference temperature used to calculate the temperature compensated viscosity.	-273.15 to 99 999 °C	0 °C
Compensation coefficient X 1	Enter compensation coefficient used to calculate the temperature compensated viscosity.	Signed floating-point number	0
Compensation coefficient X 2	Enter compensation coefficient used to calculate the temperature compensated viscosity.	Signed floating-point number	0

4.1.2 Dynamic viscosity

Navigation

"Setup" menu → Advanced setup → Viscosity → Dynamic viscosity

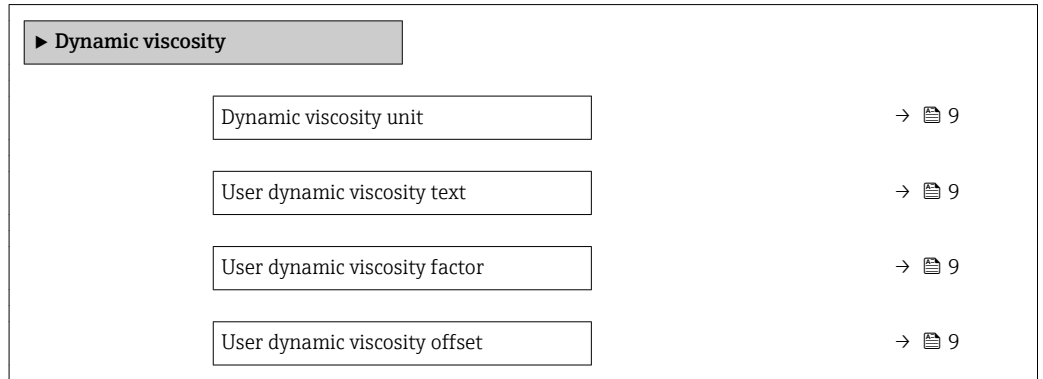

Parameter overview with brief description

Parameter	Description	Selection / User entry	Factory setting
Dynamic viscosity unit	Select dynamic viscosity unit. <i>Result</i> The selected unit applies for: <ul style="list-style-type: none"> ▪ Dynamic viscosity parameter (gases) ▪ Dynamic viscosity parameter (liquids) 	Unit choose list	Pa s
User dynamic viscosity text	Enter text for the user specific unit of the dynamic viscosity.		UserDynVis
User dynamic viscosity factor	With user-specific unit: Enter a factor which is multiplied with the measured dynamic viscosity value.	Signed floating-point number	1.0
User dynamic viscosity offset	With user-specific unit: Enter zero point shift which is added or subtracted to/from the measured value of the dynamic viscosity.	Signed floating-point number	0

4.1.3 Kinematic viscosity

Navigation

"Setup" menu → Advanced setup → Viscosity → Kinematic viscosity

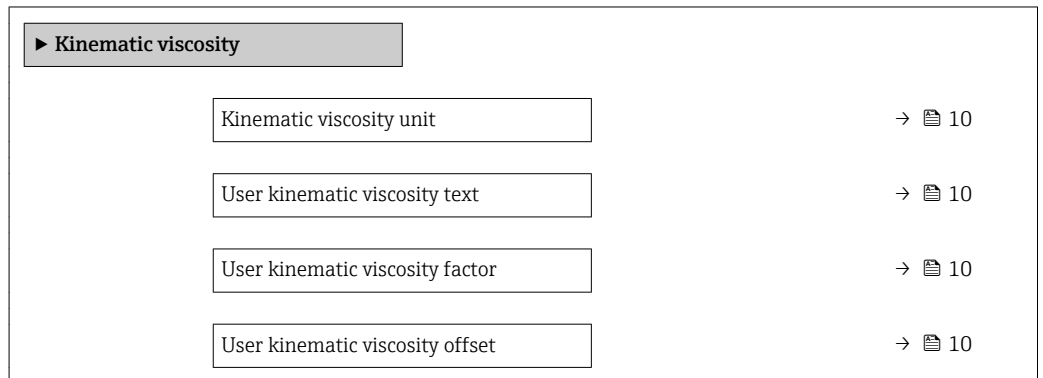

Parameter overview with brief description

Parameter	Description	Selection / User entry	Factory setting
Kinematic viscosity unit	Select kinematic viscosity unit.	Unit choose list	cSt
User kinematic viscosity text	Enter text for the user specific unit of the kinematic viscosity.		UserKinVis
User kinematic viscosity factor	With user-specific unit: Enter a factor which is multiplied with the measured kinematic viscosity value.	Signed floating-point number	1.0
User kinematic viscosity offset	With user-specific unit: Enter zero point shift which is added or subtracted to/from the measured value of the kinematic viscosity.	Signed floating-point number	0

4.2 Simulation

Navigation

"Diagnostics" menu → Simulation → Assign simulation process variable

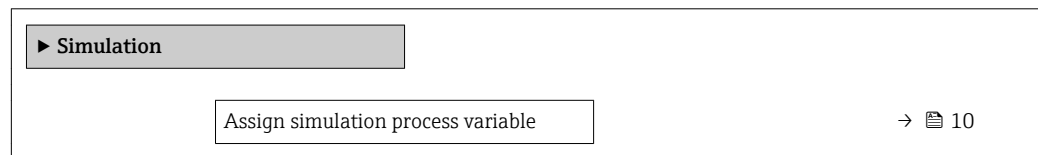

Parameter overview with brief description

Parameter	Description	Selection	Factory setting
Assign simulation process variable	Select a process variable for the simulation process that is activated.	<ul style="list-style-type: none"> ■ Off ■ Mass flow ■ Volume flow ■ Corrected volume flow ■ Density ■ Reference density ■ Temperature ■ Dynamic viscosity ■ Kinematic viscosity ■ Temp. compensated dynamic viscosity ■ Temp. compensated kinematic viscosity 	Off

5 Operation

5.1 Reading measured values

Navigation

"Diagnostics" menu → Measured values → Process variables

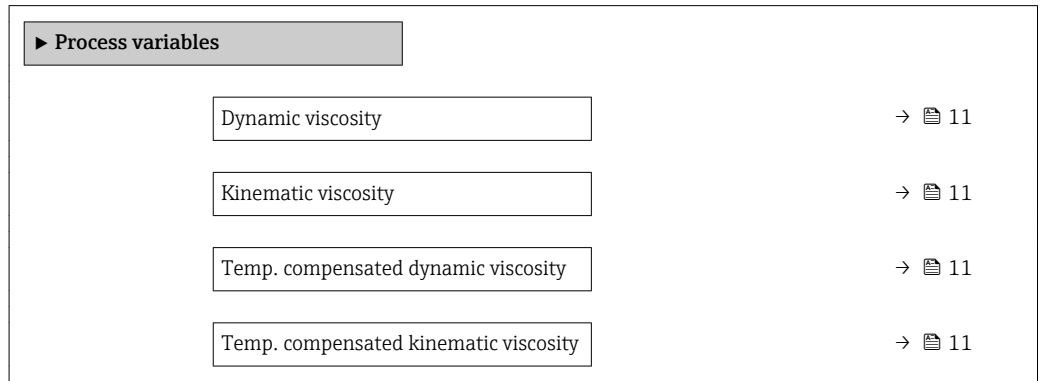

Parameter overview with brief description

Parameter	Prerequisite	Description	User interface
Dynamic viscosity	For the following order code: "Application package", option EG "Viscosity" The software options currently enabled are displayed in the Software option overview parameter.	Displays the dynamic viscosity currently calculated. <i>Dependency</i> The unit is taken from the Dynamic viscosity unit parameter (→ 9).	Signed floating-point number
Kinematic viscosity	For the following order code: "Application package", option EG "Viscosity" The software options currently enabled are displayed in the Software option overview parameter.	Displays the kinematic viscosity currently calculated. <i>Dependency</i> The unit is taken from the Kinematic viscosity unit parameter (→ 10).	Signed floating-point number
Temp. compensated dynamic viscosity	For the following order code: "Application package", option EG "Viscosity" The software options currently enabled are displayed in the Software option overview parameter.	Displays the temperature compensation currently calculated for the viscosity. <i>Dependency</i> The unit is taken from the Dynamic viscosity unit parameter (→ 9).	Signed floating-point number
Temp. compensated kinematic viscosity	For the following order code: "Application package", option EG "Viscosity" The software options currently enabled are displayed in the Software option overview parameter.	Displays the temperature compensation currently calculated for the kinetic viscosity. <i>Dependency</i> The unit is taken from the Kinematic viscosity unit parameter (0578) (→ 10).	Signed floating-point number

6 Technical data

6.1 Input

6.1.1 Measuring range

Measuring ranges for liquids

DN		Measuring range full scale values $\dot{m}_{\min(F)}$ to $\dot{m}_{\max(F)}$	
[mm]	[in]	[kg/h]	[lb/min]
8	$\frac{3}{8}$	0 to 2 000	0 to 73.50
15	$\frac{1}{2}$	0 to 6 500	0 to 238.9
15 FB	$\frac{1}{2}$ FB	0 to 18 000	0 to 661.5
25	1	0 to 18 000	0 to 661.5
25 FB	1 FB	0 to 45 000	0 to 1 654
40	$1\frac{1}{2}$	0 to 45 000	0 to 1 654
40 FB	$1\frac{1}{2}$ FB	0 to 70 000	0 to 2 573
50	2	0 to 70 000	0 to 2 573
50 FB	2 FB	0 to 180 000	0 to 6 615
80	3	0 to 180 000	0 to 6 615

FB = Full bore

Measuring ranges for gases

The full scale values depend on the density of the gas and can be calculated with the formula below:

$$\dot{m}_{\max(G)} = \dot{m}_{\max(F)} \cdot \rho_G \cdot x$$

$\dot{m}_{\max(G)}$	Maximum full scale value for gas [kg/h]
$\dot{m}_{\max(F)}$	Maximum full scale value for liquid [kg/h]
$\dot{m}_{\max(G)} < \dot{m}_{\max(F)}$	$\dot{m}_{\max(G)}$ can never be greater than $\dot{m}_{\max(F)}$
ρ_G	Gas density in [kg/m ³] at operating conditions
x	Constant dependent on nominal diameter

DN		x
[mm]	[in]	[kg/m ³]
8	$\frac{3}{8}$	60
15	$\frac{1}{2}$	80
15 FB	$\frac{1}{2}$ FB	90
25	1	90
25 FB	1 FB	90
40	$1\frac{1}{2}$	90
40 FB	$1\frac{1}{2}$ FB	90
50	2	90
50 FB	2 FB	110

DN		x
[mm]	[in]	[kg/m ³]
80	3	110
FB = Full bore		

Calculation example for gas

- Sensor: Promass I, DN 50
- Gas: Air with a density of 60.3 kg/m³ (at 20 °C and 50 bar)
- Measuring range (liquid): 70 000 kg/h
- x = 90 kg/m³ (for Promass I, DN 50)

Maximum possible full scale value:

$$\dot{m}_{\max(G)} = \dot{m}_{\max(F)} \cdot \rho_G : x = 70\,000 \text{ kg/h} \cdot 60.3 \text{ kg/m}^3 : 90 \text{ kg/m}^3 = 46\,900 \text{ kg/h}$$

6.2 Performance characteristics

6.2.1 Maximum measured error

Accuracy for Newtonian liquids	±5% ± 0.5 mPa·s (cP) of reading
--------------------------------	---------------------------------

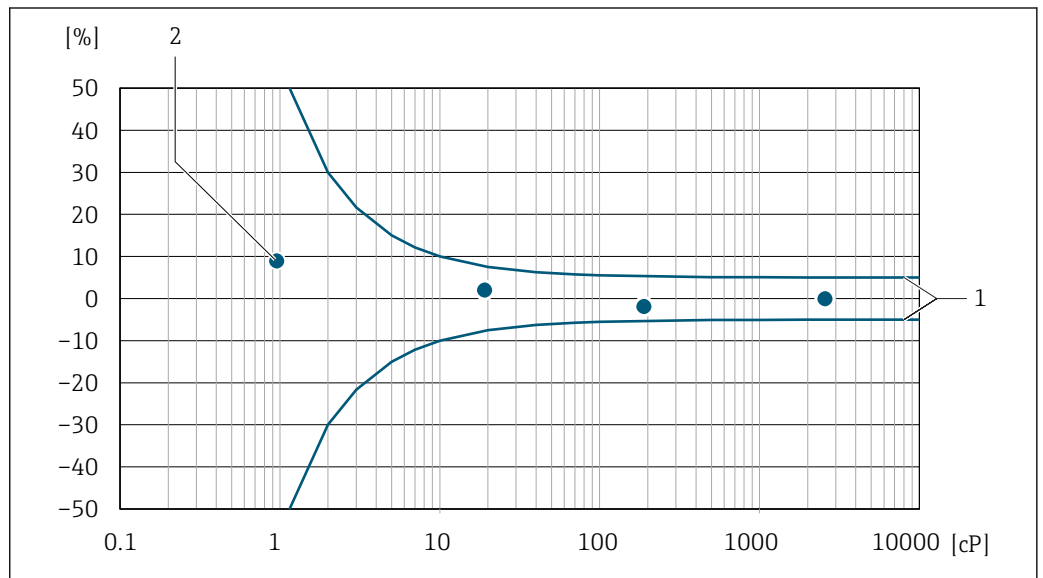

1 Error curve indicating the relative error as a % for dynamic viscosity in cP

1 Maximum measured error

2 Typical measuring points of viscosity calibration

If the process temperature is not within the valid range +5 to +80 °C (+41 to +176 °F), the additional measured error is ±0.14 v.M./°C (±0.07 v.M./°F)

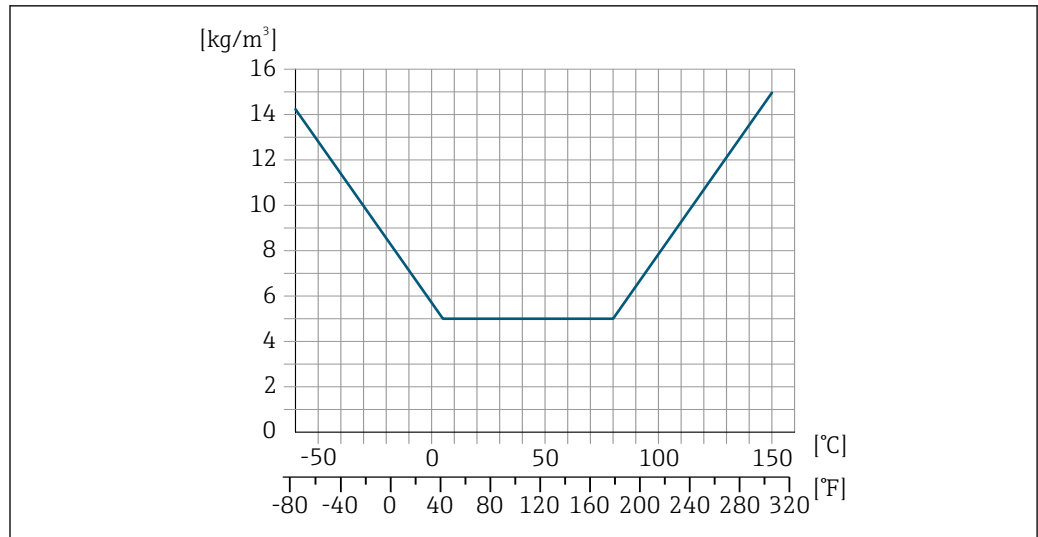

A0034803

2 Measured error if process temperature is not within the valid range



6.2.2 Repeatability

$\pm 0.5\%$ of reading

7 Viscosity fundamentals

Viscosity describes the flow properties of fluids (liquid and gas). This property depends on forces acting between the molecules. The more viscous a fluid, the stronger these intermolecular forces. As a result, a larger internal resistance has to be overcome to move through the fluid or apply a force to it.

7.1 Definitions of viscosity (general)

Consider a liquid between two parallel plates. If you slide one of the plates parallel against the other in a horizontal direction, →  3,  15 a certain force F (shear force) is needed as the liquid acts against the flow movement in the form of an internal resistance.

The relationship between the moving surface A and the shear force F is known as shear stress τ .

$$\tau = \frac{F}{A} \quad \text{Pa} = \frac{\text{N}}{\text{m}^2}$$

A0019949

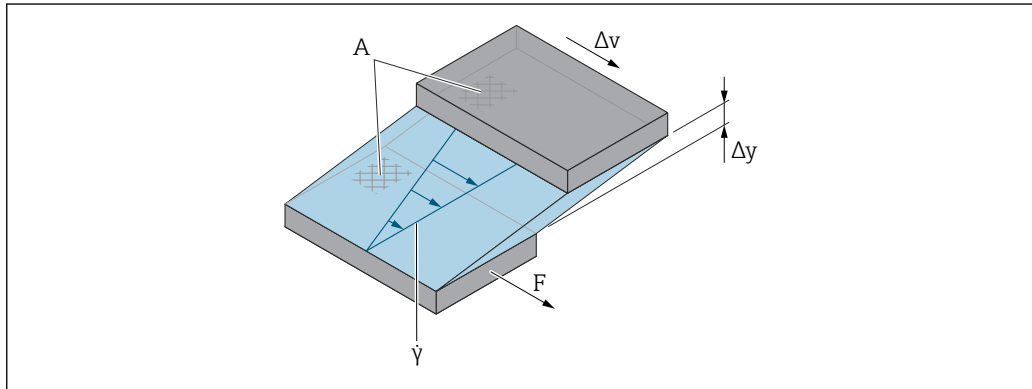

A0032625

 3 Shear rate

- A Friction surface
- F Shear force
- $\dot{\gamma}$ Shear rate
- Δv Change in velocity
- Δy Distance between plates or layer thickness

The relationship between the change in velocity Δv and layer thickness Δy (distance between the plates) is known as the shear rate $\dot{\gamma}$.

$$\dot{\gamma} = \frac{\Delta y}{\Delta v} \quad \frac{\text{m}}{\text{m}\cdot\text{s}} = \frac{1}{\text{s}}$$

A0019948

7.1.1 Dynamic viscosity

The dynamic viscosity (η) is calculated from the ratio of the shear stress τ to the shear rate $\dot{\gamma}$.

$$\eta = \frac{\tau}{\dot{\gamma}} = \frac{F/A}{\Delta v / \Delta y} = \frac{F \cdot \Delta y}{A \cdot \Delta v} \quad \frac{\text{N/m}^2}{(\text{m/s})/\text{m}} = \frac{\text{N} \cdot \text{m}}{(\text{m/s}) \cdot \text{m}^2} = \frac{\text{N} \cdot \text{s}}{\text{m}^2} = \text{Pa} \cdot \text{s}$$

A0019947

The SI unit for dynamic viscosity η is the pascal second (Pa · s). The poise (P) unit is also widely used, where:

$$1 \text{ mPa} \cdot \text{s} = 1 \text{ cP}$$

$$1 \text{ Pa} \cdot \text{s} = 10 \text{ P}$$

A selection of the most common used viscosity units: →  23.

7.1.2 Kinematic viscosity

The kinematic viscosity ν is the quotient from the dynamic viscosity η of the liquid and its density ρ .

$$\nu = \frac{\eta}{\rho} \quad \frac{(\text{N} \cdot \text{s})/\text{m}^2}{\text{kg}/\text{m}^3} = \frac{(\text{kg} \cdot \text{m}/\text{s}^2 \cdot \text{s})/\text{m}^2}{\text{kg}/\text{m}^3} = \frac{\text{m}^2}{\text{s}}$$

A0019950

The SI unit of kinematic viscosity is m^2/s . However, the stokes (St) unit is also widely used, where:

$$1 \text{ m}^2/\text{s} = 1\,000\,000 \text{ cSt}$$

$$1 \text{ mm}^2/\text{s} = 1 \text{ cSt (centistokes)}$$

A selection of the most commonly used viscosity units: →  23.

7.2 Differentiating viscous behavior

A distinction is made between Newtonian liquids and non-Newtonian liquids based on their viscosity behavior at different shear rates. In Newtonian liquids, the viscosity behavior remains constant at different shear rates. In non-Newtonian liquids, the viscosity behavior changes at different shear rates.

7.2.1 Newtonian liquid

	Example	Viscosity behavior with increasing shear rate
Feature	<ul style="list-style-type: none"> ▪ Water ▪ Lube oils 	No effect

7.2.2 Non-Newtonian liquid

		Example	Viscosity behavior with increasing shear rate
Time-independent behavior	Dilatant liquid	<ul style="list-style-type: none"> ▪ Concentrated solutions of sugar and water ▪ Aqueous suspensions of rice starch ▪ Wet sand 	Increases
	Pseudoplastic liquid	<ul style="list-style-type: none"> ▪ Gelatine ▪ Clay ▪ Milk ▪ Cream ▪ Fruit juice concentrate ▪ Salad dressings 	Increases
	Bingham liquid	<ul style="list-style-type: none"> ▪ Certain emulsions ▪ Oil paint 	Decreases but acts like a Newtonian liquid as of a certain shear rate
Time-dependent behavior	Thixotropic liquid	<ul style="list-style-type: none"> ▪ Yogurt ▪ Mayonnaise ▪ Margarine ▪ Ice cream ▪ Paints 	Decreases but assumes the original state when in quiescent state
	Rheopectic liquid	<ul style="list-style-type: none"> ▪ Gypsum in water ▪ Printer ink 	Increases but drops again when in quiescent state

7.2.3 Viscosity and flow curves

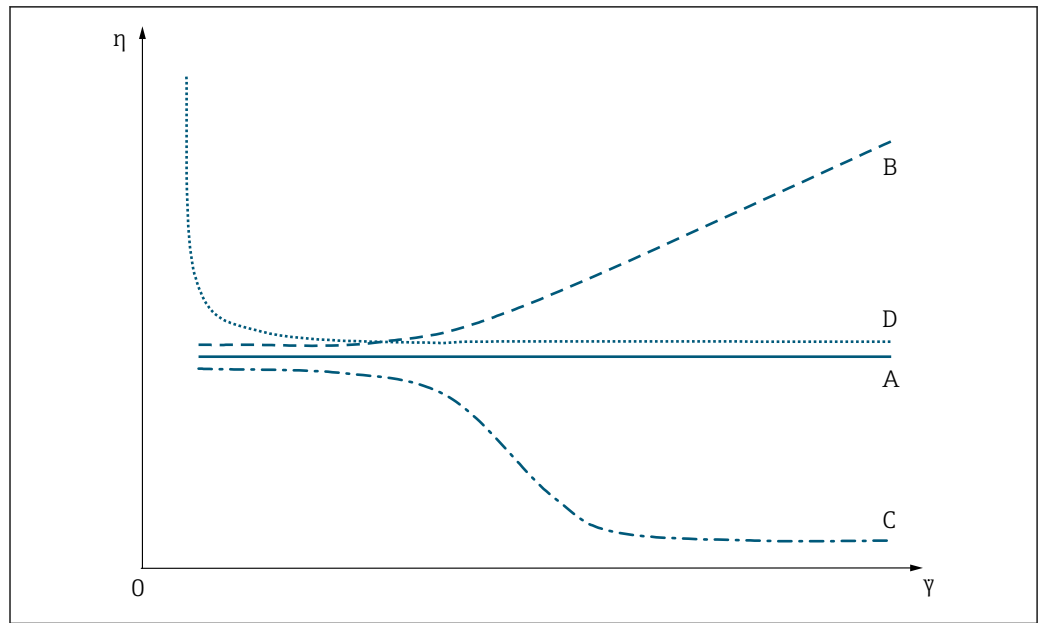

A0032622

4 Viscosity curves

- A Viscosity curve of a Newtonian liquid
- B Viscosity curve of a dilatant liquid
- C Viscosity curve of a pseudoplastic liquid
- D Viscosity curve of a Bingham-plastic liquid
- $\dot{\gamma}$ Shear rate
- η Dynamic viscosity

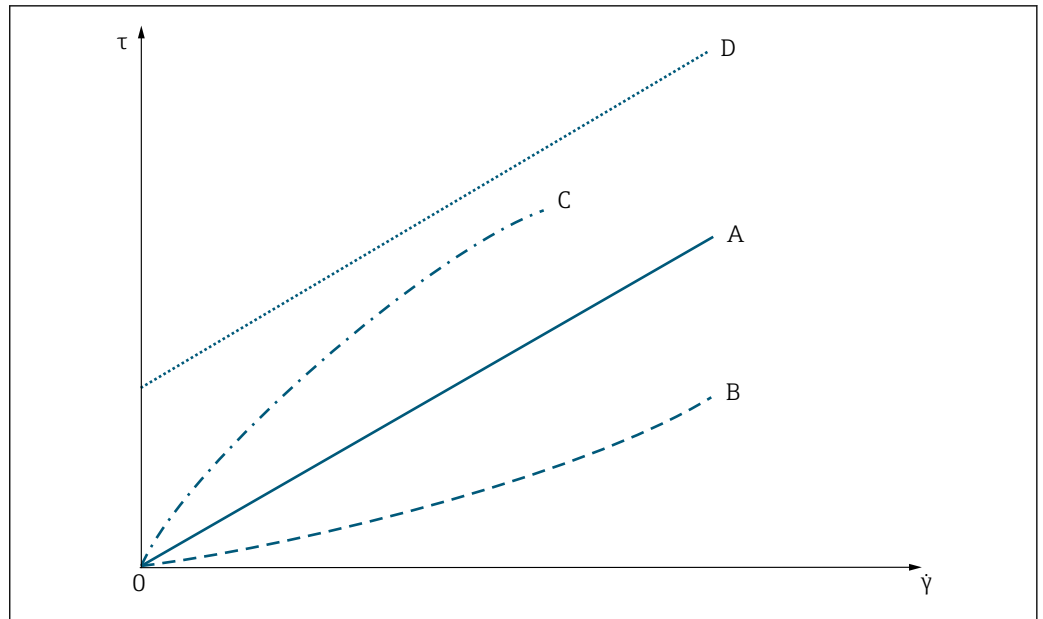

A0032623

5 Flow curves

- A Flow curve of a Newtonian liquid
- B Flow curve of a dilatant liquid
- C Flow curve of a pseudoplastic liquid
- D Flow curve of a Bingham-plastic liquid
- $\dot{\gamma}$ Shear rate
- τ Shear stress

7.3 Principle of viscosity measurement with Promass I

The patented measuring principle is based on torsional movement of the measuring tube:

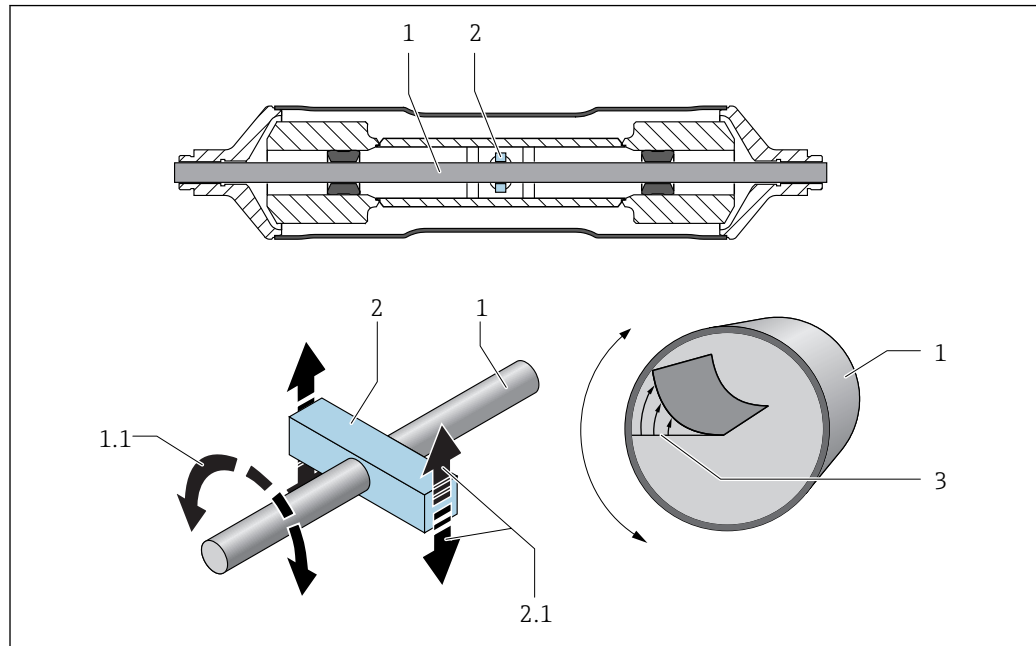

A0032631

- 1 Measuring tube
- 1.1 Rotational movement of the measuring tube
- 2 Torsion bar
- 2.1 Rotational movement of the torsion bar
- 3 Velocity profile in the medium

A "torsion bar" (2) fitted to the measuring tube (1) imposes a rotational movement (torsional movement) which is used to measure viscosity. This torsional movement creates a velocity profile in the medium (3) across the pipe cross-section. The velocity profile is thus an expression of the fluid viscosity. The viscosity of the medium dampens the oscillation of the measuring tube. Therefore, if viscosity is high, more excitation power (force, in other words) is needed to sustain the torsional movement. Thus, dynamic viscosity is determined by measuring the required excitation power. Fluid density is measured independently and simultaneously, so the kinematic viscosity can be determined as well.

7.4 Temperature correction of the viscosity value

The viscosity of a liquid depends on the temperature of the medium. Usually, the viscosity decreases with increasing temperatures.

The temperature effect becomes clear when laboratory and process measurements are compared. The process and laboratory temperatures normally deviate from one another. To be able to compare both measurements, the measuring device can calculate the process viscosity back to a reference temperature using various models. Three calculation models are available for this purpose. → 22. The model selected should be the one for which the viscosity behavior has the lowest error deviations. → 6, 21.

The device calculates the temperature correction of the viscosity value based on the compensation coefficients X1 and X2 . → 8.

The following example illustrates the correction of the viscosity to 20 °C:

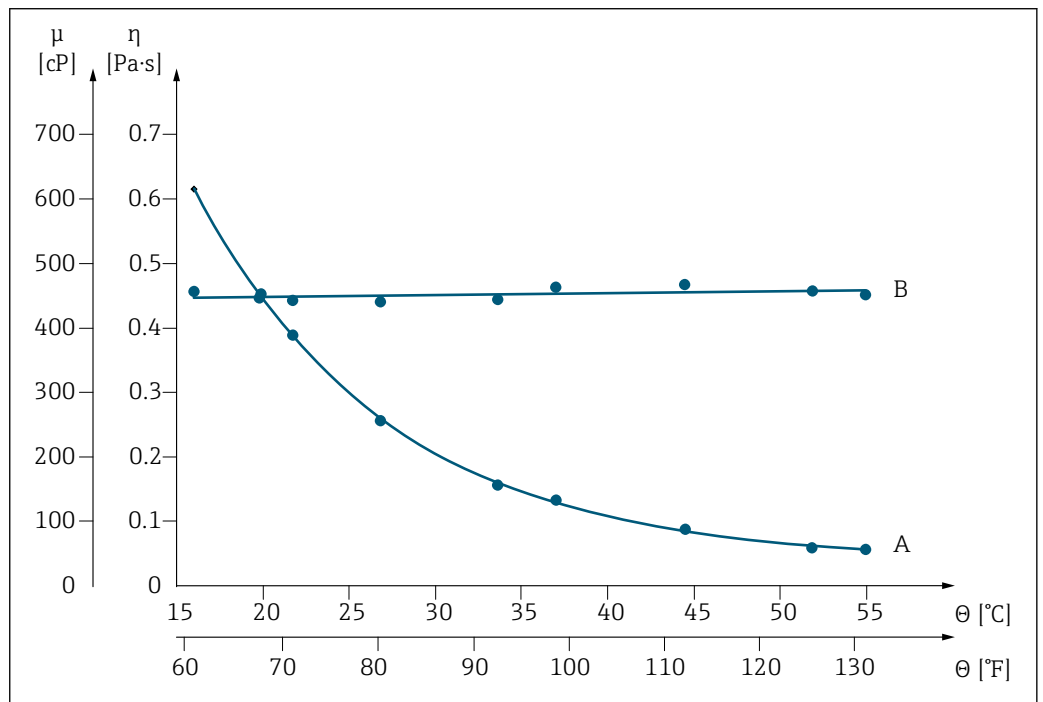

6 Temperature correction of viscosity of glycerin to 20 °C

- μ, η Dynamic viscosity
- θ Temperature
- A Measured value under process conditions
- B Calculated standard viscosity referenced to 20°C

7.5 Formula models for temperature correction

The measuring device calculates the temperature correction of the viscosity value on the basis of the following formulas:

Models	Dynamic viscosity η
Power law	$\eta_N = \eta \cdot x_1 \cdot (\theta/\theta_{ref})^{x_2}$
Exponential	$\eta_N = \eta \cdot x_1 \cdot e^{x_2 \cdot (\theta - \theta_{ref})}$
Polynomial	$\eta_N = \eta \cdot [1 + x_1 \cdot (\theta - \theta_{ref}) + x_2 \cdot (\theta - \theta_{ref})^2]$

Models	Kinematic viscosity η
General	$v_N = \eta_N / \rho_N$

η_N	Dynamic viscosity under standard/laboratory conditions
η	Dynamic viscosity at process temperature
x_1	Compensation coefficient X_1
x_2	Compensation coefficient X_2
θ	Process temperature
θ_{ref}	Reference temperature
v_N	Kinematic viscosity under standard/laboratory conditions
ρ_N	Reference density

-  In the event of large temperature differences between the liquid and the environment, pipe heating or insulation can help avoid cooling effects of the liquid.
- If more than one liquid should be measured with temperature correction the calculation should take place externally (e.g. in a PLC).

8 Comparison tables for viscosities

Centipoise (cP) (mPa · s) ¹⁾	Poise (P)	DIN cup 4 (s) ²⁾	Pascal second (Pa · s) ³⁾	°Engler	Ford cup 4 (s) ²⁾
10	0.1	10	0.01	1.83	5
15	0.15	11	0.015	2.32	8
20	0.2	12	0.02	2.87	10
25	0.25	13	0.025	3.46	12
30	0.3	14	0.03	4.07	14
40	0.4	15	0.04	5.33	18
50	0.5	16	0.05	6.62	22
60	0.6	18	0.06	7.93	25
70	0.7	21	0.07	9.23	28
80	0.8	23	0.08	10.54	32
90	0.9	25	0.09	11.86	34
100	1	27	0.1	13.17	37
120	1.2	31	0.12	15.8	43
140	1.4	34	0.14	18.43	48
160	1.6	38	0.16	21.06	54
180	1.8	43	0.18	23.69	58
200	2	46	0.2	26.3	64
220	2.2	51	0.22	28.9	70
240	2.4	55	0.24	31.6	75
260	2.6	58	0.26	34.2	80
280	2.8	63	0.28	36.8	86
300	3	68	0.3	39.4	93
320	3.2	72	0.32	42.1	100
340	3.4	76	0.34	44.7	107
360	3.6	82	0.36	47.4	112
380	3.8	86	0.38	50	119
400	4	90	0.4	52	124
420	4.2	95	0.42	55.1	130
440	4.4	100	0.44	57.6	138
460	4.6	104	0.46	60.4	142
480	4.8	109	0.48	63.0	150
500	5.0	112	0.50	65.8	155
550	5.5	124	0.55	72.4	170
600	6.0	135	0.60	79.0	185
700	7.0	160	0.70	92.1	220
800	8.0	172	0.80	105.2	249
900	9.0	195	0.90	117.8	280
1000	10.0	218	1	131.6	310

- 1) Milli Pascal second
- 2) Second
- 3) Pascal second

www.addresses.endress.com
